

URBAN DESIGN COMMISSION APPLICATION

UDC

City of Madison
Planning Division
Madison Municipal Building, Suite 017
215 Martin Luther King, Jr. Blvd.
P.O. Box 2985
Madison, WI 53701-2985
(608) 266-4635



FOR OFFICE USE ONLY:

Date Received _____ Initial Submittal
Paid _____ Revised Submittal

Complete all sections of this application, including the desired meeting date and the action requested. If your project requires both UDC and Land Use application submittals, a completed [Land Use Application](#) and accompanying submittal materials are also required to be submitted.

If you need an interpreter, translator, materials in alternate formats or other accommodations to access these forms, please call the Planning Division at (608) 266-4635.

Si necesita interprete, traductor, materiales en diferentes formatos, u otro tipo de ayuda para acceder a estos formularios, por favor llame al (608) 266-4635.

Yog tias koj xav tau ib tug neeg txhais lus, tus neeg txhais ntawv, los sis xav tau cov ntaub ntawv ua lwm hom ntawv los sis lwm cov kev pab kom paub txog cov lus qhia no, thov hu rau Koog Npaj (Planning Division) (608) 266-4635.

1. Project Information

Address (list all addresses on the project site): 339 W Gorham St.

Title: Oliv Building & Retail Spaces

2. Application Type (check all that apply) and Requested Date

UDC meeting date requested 6/12/24 or 6/29/24

- New development Alteration to an existing or previously-approved development
 Informational Initial Approval Final Approval

3. Project Type

- Project in an Urban Design District
 Project in the Downtown Core District (DC), Urban Mixed-Use District (UMX), or Mixed-Use Center District (MXC)
 Project in the Suburban Employment Center District (SEC), Campus Institutional District (CI), or Employment Campus District (EC)
 Planned Development (PD)
 General Development Plan (GDP)
 Specific Implementation Plan (SIP)
 Planned Multi-Use Site or Residential Building Complex

Signage

- Comprehensive Design Review (CDR)
 Modifications of Height, Area, and Setback
 Sign Exceptions as noted in [Sec. 31.043\(3\)](#), MGO

Other

- Please specify _____

4. Applicant, Agent, and Property Owner Information

Applicant name Harmonic Hospitality Group
Street address 6027 University Ave #100
Telephone (630)862-9210

Company Harmonic Hospitality Group
City/State/Zip Cedar Falls, IA 50613
Email Aaron Schurman - schurmster@gmail.com

Project contact person Allie Klocek / Dan Yoder
Street address 325 W Front St
Telephone 608-437-2320 xt 305

Company Sign Art Studio
City/State/Zip Mount Horeb, WI 53572
Email Dan@makesignsnotwar.com / allie@makesignsnotwar.com

Property owner (if not applicant) Core Spaces
Street address 1643 N Milwaukee Ave 5th Floor
Telephone 630.887.7242

City/State/Zip Chicago, IL 60647
Email Brentp@corespaces.com

Introduction

The City of Madison's Urban Design Commission (UDC) has been created to:

- Encourage and promote high quality in the design of new buildings, developments, remodeling, and additions so as to maintain and improve the established standards of property values within the City.
- Foster civic pride in the beauty and nobler assets of the City, and in all other ways possible assure a functionally efficient and visually attractive City in the future.

Types of Approvals

There are three types of requests considered by the UDC:

- Informational Presentation. A request for an Informational Presentation to the UDC may be requested prior to seeking any approvals to obtain early feedback and direction before undertaking detailed design efforts. Applicants should provide details on the context of the site, design concept, site and building plans, and other relevant information to help the UDC understand the proposal and provide feedback. (Does not apply to CDR's or Signage Modification requests)
- Initial Approval. Applicants may, at their discretion, request Initial Approval of a proposal by presenting preliminary design information. As part of their review, the Commission will provide feedback on the design information that should be addressed at Final Approval stage.
- Final Approval. Applicants may request Final Approval of a proposal by presenting all final project details. Recommendations or concerns expressed by the UDC in the Initial Approval must be addressed at this time.

Presentations to the Commission

The Urban Design Commission meets virtually via Zoom, typically on the second and fourth Wednesdays of each month at 4:30 p.m. Applicant presentations are strongly encouraged, although not required. Prior to the meeting, each individual speaker is required to complete an online registration form to speak at the meeting. A link to complete the online registration will be provided by staff prior to the meeting. Please note that individual presentations will be limited to a **maximum of three (3) minutes**. The pooling of time may be utilized to provide one speaker more time to present, however the additional time will be based on the number of registrants from the applicant team, i.e. two (2) applicant registrants = six (6) minutes for one (1) speaker.

Primarily, the UDC is interested in the appearance and design quality of projects. Emphasis should be given to the site plan, landscape plan, lighting plan, building elevations, exterior building materials, color scheme, and graphics. Please note that presentation slides, in a PDF file format, are required to be submitted **the Friday before** the UDC meeting.

URBAN DESIGN DEVELOPMENT PLANS CHECKLIST

The items listed below are minimum application requirements for the type of approval indicated. Please note that the UDC and/or staff may require additional information in order to have a complete understanding of the project.

1. Informational Presentation

- Locator Map
- Letter of Intent (If the project is within an Urban Design District, a summary of how the development proposal addresses the district criteria is required)
- Contextual site information, including photographs and layout of adjacent buildings/structures
- Site Plan
- Two-dimensional (2D) images of proposed buildings or structures.

Providing additional information beyond these minimums may generate a greater level of feedback from the Commission.

Requirements for All Plan Sheets

1. Title block
2. Sheet number
3. North arrow
4. Scale, both written and graphic
5. Date
6. Fully dimensioned plans, scaled at 1"= 40' or larger

*** All plans must be legible, including the full-sized landscape and lighting plans (if required)*

2. Initial Approval

- Locator Map
- Letter of Intent (If the project is within a Urban Design District, a summary of how the development proposal addresses the district criteria is required)
- Contextual site information, including photographs and layout of adjacent buildings/structures
- Site Plan showing location of existing and proposed buildings, walks, drives, bike lanes, bike parking, and existing trees over 18" diameter
- Landscape Plan and Plant List (*must be legible*)
- Building Elevations in **both** black & white and color for all building sides, including material and color callouts
- PD text and Letter of Intent (if applicable)

Providing additional information beyond these minimums may generate a greater level of feedback from the Commission.

3. Final Approval

All the requirements of the Initial Approval (see above), **plus**:

- Grading Plan
- Lighting Plan, including fixture cut sheets and photometrics plan (must be legible)
- Utility/HVAC equipment location and screening details (with a rooftop plan if roof-mounted)
- Site Plan showing site amenities, fencing, trash, bike parking, etc. (if applicable)
- PD text and Letter of Intent (if applicable)
- Samples of the exterior building materials
- Proposed sign areas and types (if applicable)

4. Signage Approval (*Comprehensive Design Review (CDR), Sign Modifications, and Sign Exceptions (per [Sec. 31.043\(3\)](#))*)

- Locator Map
- Letter of Intent (a summary of how the proposed signage is consistent with the CDR or Signage Modifications criteria is required)
- Contextual site information, including photographs of existing signage both on site and within proximity to the project site
- Site Plan showing the location of existing signage and proposed signage, dimensioned signage setbacks, sidewalks, driveways, and right-of-ways
- Proposed signage graphics (fully dimensioned, scaled drawings, including materials and colors, and night view)
- Perspective renderings (emphasis on pedestrian/automobile scale viewsheds)
- Illustration of the proposed signage that meets [Ch. 31, MGO](#) compared to what is being requested
- Graphic of the proposed signage as it relates to what the [Ch. 31, MGO](#) would permit

5. Required Submittal Materials

Application Form

- A completed application form is required for each UDC appearance. For projects also requiring Plan Commission approval, applicants must also have submitted an accepted application for Plan Commission consideration prior to obtaining any formal action (Initial or Final Approval) from the UDC.

Letter of Intent

- If the project is within an Urban Design District, a summary of how the development proposal addresses the district criteria is required.
- For signage applications, a summary of how the proposed signage is consistent with the applicable Comprehensive Design Review (CDR) or Signage Modification review criteria is required.

Development Plans (Refer to checklist on Page 4 for plan details)

Filing Fee (Refer to Section 7 (below) for a list of application fees by request type)

Electronic Submittal

- Complete electronic submittals must be received prior to the application deadline before an application will be scheduled for a UDC meeting. Late materials will not be accepted. All plans must be legible and scalable when reduced. Individual PDF files of each item submitted should be submitted via email to UDCapplications@cityofmadison.com. The email must include the project address, project name, and applicant name.
- Email Size Limits. Note that an individual email cannot exceed 20MB and it is the responsibility of the applicant to present files in a manner that can be accepted. Applicants who are unable to provide the materials electronically should contact the Planning Division at (608) 266-4635 for assistance.

Notification to the District Alder

- Please provide an email to the District Alder notifying them that you are filing this UDC application. Please send this as early in the process as possible and provide a copy of that email with the submitted application.

6. Applicant Declarations

1. Prior to submitting this application, the applicant is required to discuss the proposed project with Urban Design Commission staff. This application was discussed with Jessica Vaughn & Chrissy Thiele on 4/23/24.
2. The applicant attests that all required materials are included in this submittal and understands that if any required information is not provided by the application deadline, the application will not be placed on an Urban Design Commission agenda for consideration.

Name of applicant Harmonic Hospitality Group Relationship to property Retail Owner

Authorizing signature of property owner Core Madison Gorham, LLC Date 5/10/24
By: Core Campus Developer, LLC
 Its: Development Manager

7. Application Filing Fees

Fee payments are due by the submittal date. Payments received after the submittal deadline may result in the submittal being scheduled for the next application review cycle. Fees may be paid in-person, via US Mail, or City drop box. If mailed, please mail to: *City of Madison Building Inspection, P.O. Box 2984, Madison, WI 53701-2984*. The City's drop box is located outside the Municipal Building at 215 Martin Luther King, Jr. Blvd. on the E Doty Street side of the building. Please make checks payable to *City Treasurer*, and include a completed application form or cover letter indicating the project location and applicant information with all checks mailed or submitted via the City's drop box.

Please consult the schedule below for the appropriate fee for your request:

- Urban Design Districts: \$350 (per [§33.24\(6\) MGO](#)).
- Minor Alteration in the Downtown Core District (DC) or Urban Mixed-Use District (UMX) : \$150 (per [§33.24\(6\)\(b\) MGO](#))
- Comprehensive Design Review: \$500 (per [§31.041\(3\)\(d\)\(1\)\(a\) MGO](#))
- Minor Alteration to a Comprehensive Sign Plan: \$100 (per [§31.041\(3\)\(d\)\(1\)\(c\) MGO](#))
- All other sign requests to the Urban Design Commission, including, but not limited to: appeals from the decisions of the Zoning Administrator, requests for Sign Modifications (of height, area, and setback), and additional sign code approvals: \$300 (per [§31.041\(3\)\(d\)\(2\) MGO](#))

A filing fee is not required for the following project applications if part of the combined application process involving both Urban Design Commission and Plan Commission:

- Project in the Downtown Core District (DC), Urban Mixed-Use District (UMX), or Mixed-Use Center District (MXC)
- Project in the Suburban Employment Center District (SEC), Campus Institutional District (CI), or Employment Campus District (EC)
- Planned Development (PD): General Development Plan (GDP) and/or Specific Implementation Plan (SIP)
- Planned Multi-Use Site or Residential Building Complex

UDC members,

Harmonic Hospitality Group is requesting a CDR for the property 339 W Gorham. The property is owned by Core Spaces. It is zoned UMX and in the downtown district. It is a combination of residential and commercial spaces. The large-scale building is 563,452 square footage, 11 floors and basically takes up an entire block. The building fronts W Gorham, State Street, W Johnson, and N Broom St. The package provides the approved residential signage and the proposed signage for current and future commercial spaces.

The residential signage that has been approved is a blade, canopy, and wall sign. The blade and the canopy sign help denote the lobby/main entrance for the residential space.

Existing Signage Approved:

1 ct. HUB Blade Sign

-15.84 sq. ft

-under clearance 18'-8"

-LED face lit illumination

1 ct. HUB Canopy Sign

-11.5 sq. ft.

-2' max height over canopy

-LED face lit illumination

1 ct. HUB Parking Wall Sign

-17.84 sq. ft.

-LED face lit illumination and not lit PARKING letters

The signage fits the scale for the 1 block building and is critical to guide visitors to the entry. Enclosed are the drawings for the residential space that have been issued permits already from the city.

The approved signage for the Oliv/HUB and the proposed signs for the commercial spaces create visual harmony because we are using the same type and style sign at each tenant space. The lighting is face illuminated. The signage proposed provides consistency between the spaces. The proposed signage plan is designed to keep uniformity and create visual harmony between all the spaces while fitting in with the building design. As you can see in the photos provided, the building has many doors, windows, and architectural details. The sign plan proposed will eliminate mismatched signs and keep the architectural details of the building free from signage. The building does not have desirable signable areas with all the architectural details. The property has the potential to have 7 commercial spaces. Four of the spaces front W Gorham and State and three of the spaces front W Johnson.

We are seeking approval on 3 ct. commercial spaces signage and future commercial signage locations.

Included in the submittal is the signage for Roxxy, Stuffed Olive and Double Tap which are currently in the build out phase. Roxxy is taking up two commercial spaces. This is important because the bar will have two different entrances that are used at different times during the week and for private events. The entries will be open on different days depending on the private event or day of the week. The logo for Roxxy is a unique font and will slightly drop over the face of the canopy, but only has a max height of 2' above canopy which meets Chapter 31 – 31.071(c)2. The logo does not go beyond the bottom of the canopy fascia.

Proposed Signage:

Roxxy – Tenant Spaces 1 & 2

1 ct. Canopy Mounted Sign

-18.53 sq. ft.

-LED face lit illumination

-2' max letter height above canopy

1ct Blade Sign-A

-8 sq. ft

-under clearance 11'-6"

for Roxxy We are asking for an exception to allow more than one blade on one elevation due to existing Oliv/Hub blade sign.

Stuffed Olive – Tenant Space 3

1 ct. Blade Sign

-14 sq. ft

-under clearance 11'-6"

-LED face lit illumination

1 ct. Canopy Sign

-16.12 sq. ft.

-2' max height over canopy

Double Tap – Tenant Space 4

1 ct. Blade Sign

-14 sq. ft

-under clearance 11'-6"

-LED face lit illumination

1 ct. Canopy Sign

-8.89 sq. ft.

-2' max height over canopy

-Requesting exception for 2 ct. blade signs on one elevation

With the sizable building the signs guide visitors to the correct entrance and location. Again, it is crucial to help guide the visitors to the correct location and entry points. You will have new visitors to these commercial spaces often. Signage is the only way to differentiate the spaces. Some residential entries are sprinkled in between the tenant spaces.

Any future commercial tenant will have to install signs with the requirements detailed below. Each new sign will require a sign permit and review from the City of Madison.

Future Tenant Signage Requirements:

-1 ct. Blade sign per tenant space

1. Max square footage of 14 sq. ft. – Code allows 20 sq. ft. but with multiple blade signs on the building we are limiting the size. We would like flexibility for future blade sign layouts based on proportions of future tenant logos.

2. Under clearance of 11'-6" and shall not exceed the 2nd floor ceiling deck to provide install height consistency

3. 2' max projection into the right of way

-1 ct. Above Canopy sign per tenant space

1. 2' max above canopy and max overall height of 2'-5". See detail below.

2. Tenant can have the copy drop 5" down in front of the canopy not to go beyond the bottom of the canopy fascia.

3. LED face lit illumination

4. Sign to individually mounted channel letters to a raceway

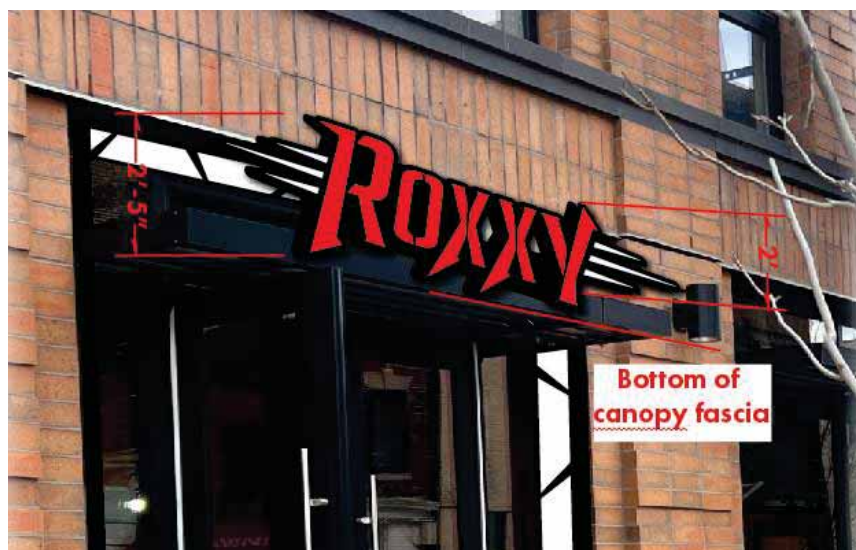

The commercial retail spaces on W Johnson St allow for 1 ct. canopy sign and 1 ct. blade sign at each location excluding space #7, only a blade sign will be allowed because no canopy is at this location.

The complete signage plan for the property provides specific uniformed locations for each commercial space and the residential space so it is cohesive. The signage will enhance the property and is appropriate for the size and scale of the property.

Thank you,

Allie Klocek – Sign Art Studio

Downtown Design Guidelines –

- a. Signage should be integrated with and be compatible with the architectural scheme of a building.

The signage plan integrates into the beautiful building and its architectural scheme. We kept the signage on the canopies and in the brick column areas to ensure no architectural features will be hindered. The signs are lower on the building for pedestrians since the purpose is to guide visitors and denote tenant spaces. The signage approved and proposed does not create clutter because it is spaced out over the tenant spaces. The design for each tenant space will provide consistency because it is required to have the same style of sign and mounting. For the Roxxy Blade sign on Gorham we are using a horizontal due to the logo orientation as well to provide a consistency in matching the horizontal layout of the existing Oliv/HUB blade on the same elevation

- b. Messages should be simple—only including the name, address, function (i.e. restaurant), and logo of the establishment.

The signage will only include the business name and the logo of the establishment for (b) Comprehensive Design Review Criteria. The UDC shall apply the following criteria upon review of an application for a Comprehensive Sign Plan:

1. The Sign Plan shall create visual harmony between the signs, building(s), and building site through unique and exceptional use of materials, design, color, any lighting, and other design elements; and shall result in signs of appropriate scale and character to the uses and building(s) on the zoning lot as well as adjacent buildings, structures and uses.

The approved signage for the Oliv/HUB and the proposed signs for the commercial spaces create visual harmony because we are using the same type and style sign at each tenant space. The lighting is face illuminated on each sign type. The signage proposed provides consistency between the spaces. The signage is appropriate for the scale of the large building. For the Roxxy Blade sign on Gorham we are using a horizontal due to the logo orientation as well to provide a consistency in matching the horizontal layout of the existing Oliv/HUB blade on the same elevation.

2. Each element of the Sign Plan shall be found to be necessary due to unique or unusual design aspects in the architecture or limitations in the building site or surrounding environment; except that when a request for an Additional Sign Code Approval under Sec. [31.043\(3\)](#) is included in the Comprehensive Design Review, the sign(s) eligible for approval under Sec. [31.043\(3\)](#) shall meet the applicable criteria of Sec. [31.043\(3\)](#), except that sign approvals that come to Comprehensive Design Review from MXC and EC districts pursuant to [31.13\(3\)](#) and (7) need not meet the criteria of this paragraph.

The building has many architectural details and features. The building does not provide signable areas for wall signs this is why for each commercial space we are proposing 1 ct. blade sign and 1 ct. canopy mounted sign. This would be for current tenants and future tenants.

3. The Sign Plan shall not violate any of the stated purposes described in Secs. [31.02\(1\)](#) and [33.24\(2\)](#). **The sign plan does not violate sections 31.02(1) and 33.24(2)**

4. All signs must meet minimum construction requirements under Sec. [31.04\(5\)](#). **The signs meet the construction requirements.**

5. The Sign Plan shall not approve Advertising beyond the restrictions in Sec. [31.11](#) or Off-Premise Directional Signs beyond the restrictions in Sec. [31.115](#). **The signs do not go beyond restrictions.**

6. The Sign Plan shall not be approved if any element of the plan:

a. presents a hazard to vehicular or pedestrian traffic on public or private property, **The proposed signs and current signs do not create vehicular or pedestrian traffic.**

b. obstructs views at points of ingress and egress of adjoining properties, **Each sign type proposed does not obstruct views and meets the minimum of 10' under clearance.**

c. obstructs or impedes the visibility of existing lawful signs on adjacent property, or **The signs do not impede visibility to adjacent properties.**

d. negatively impacts the visual quality of public or private open space. **The signs do not negatively impact the visual quality of the public or private open space.**

7. The Sign Plan may only encompass signs on private property of the zoning lot or building site in question, and shall not approve any signs in the right of way or on public property. **The signs are on the private property and are not in the right of way.**

Site Map of sign locations and commercial tenant spaces

- Approved Signage
- Proposed Signage

Commercial Tenant Spaces

- Commercial Space 1 - Roxxy
- Commercial Space 2 - Roxxy
- Commercial Space 3 - Stuffed Olive
- Commercial Space 4 - Double Tap
- Commercial Space 5
- Commercial Space 6
- Commercial Space 7

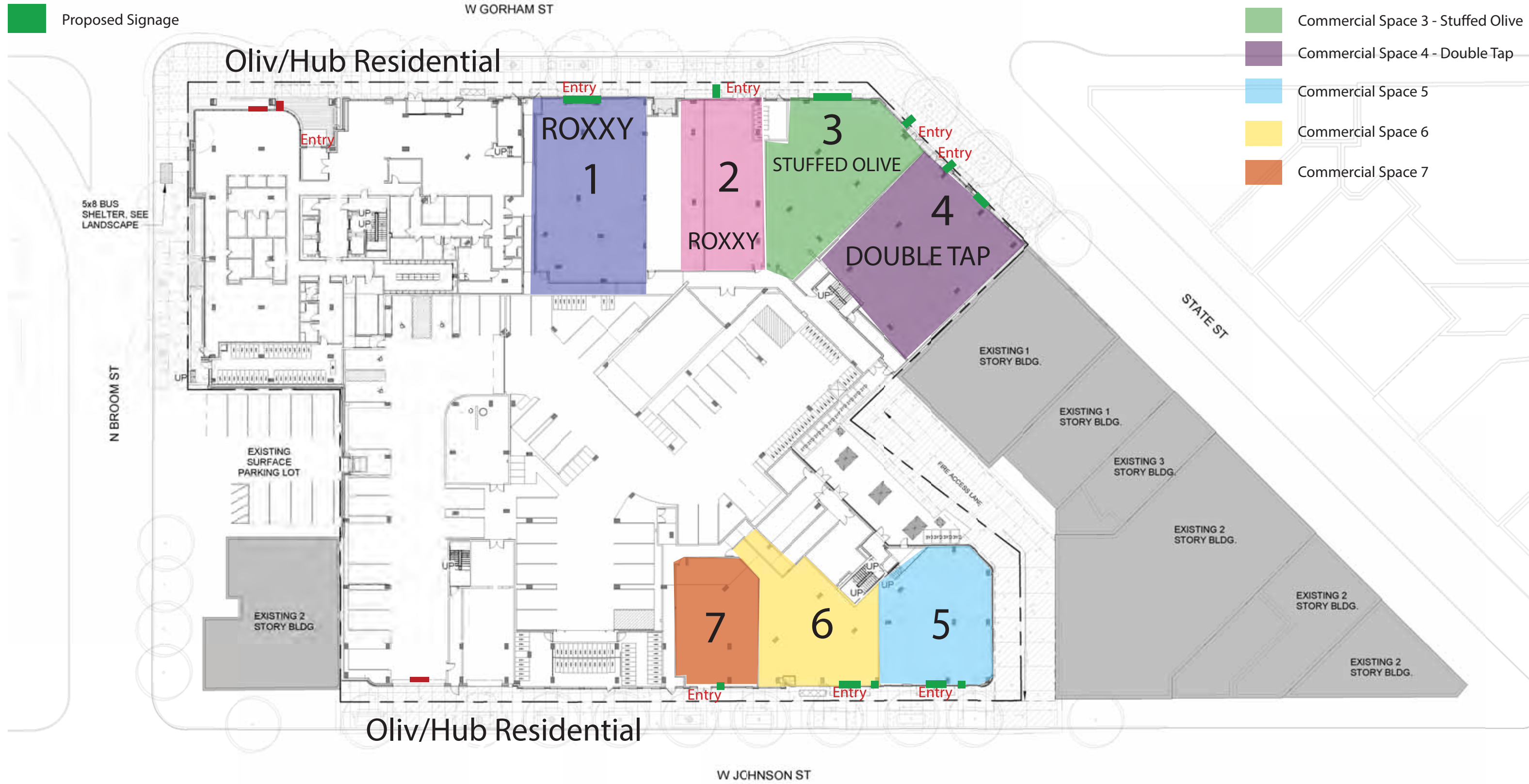

339 W Gorham - Main address - Parcel # 070923103166

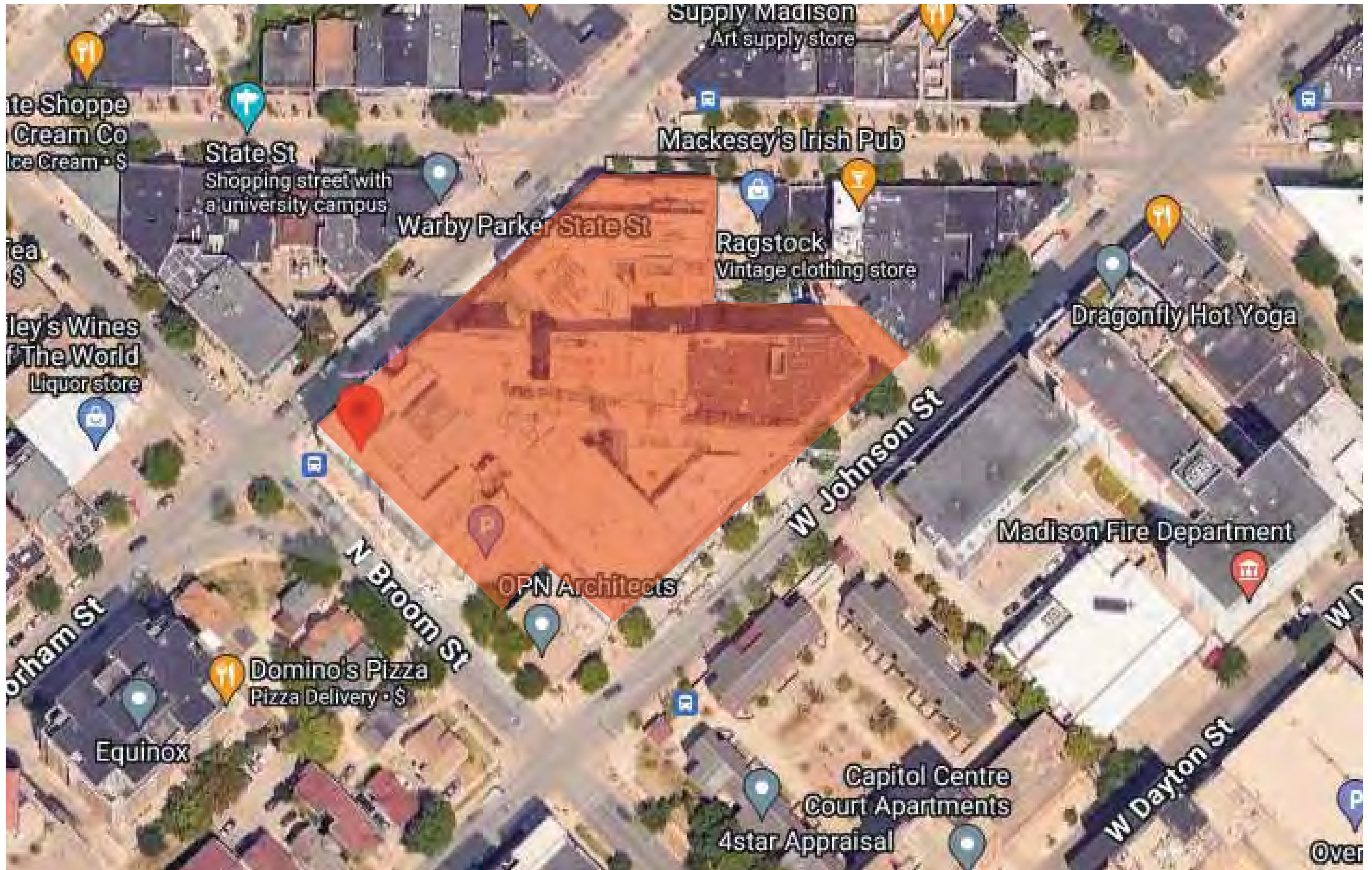

Overall Sign Plan - Existing, Proposed and Future Signage
Highlights Signage Areas
Commercial Spaces 1-4 and Oliv/Hub Canopy & Blade Sign



Proposed Double Tap Blade

Proposed Double Tap Canopy

Proposed Stuffed Olive Blade

Proposed Stuffed Olive Canopy

Proposed Roxxy Blade Sign Entrance 2

Proposed Roxxy Canopy Entrance 1

Approved Oliv/HUB Blade

Approved Oliv/ HUB Canopy

STATE STREET

W GORHAM

Overall Sign Plan - Existing, Proposed and Future Signage

Highlights Signage Areas

Commercial Spaces 5-7 and Oliv/ Hub Wall Sign



Approved Oliv/ HUB Wall

W JOHNSON
Continued



Future Blade Commercial Tenant 7

Future Canopy Commercial Tenant 6

Future Blade Commercial Tenant 6

Future Blade Commercial Tenant 5

Future Canopy Commercial Tenant 5

W JOHNSON



Double Tap Canopy Sign

Double Tap Blade Sign

Stuffed Olive Blade Sign

Stuffed Olive Canopy Sign

Roxxy Blade Sign Entrance 2

Roxxy Canopy Sign Entrance 1

Oliv Blade Sign

Oliv Canopy Sign

STATE STREET

W GORHAM

Secondary Entry : Logo to be face lit channel letters with illuminated inner archway



North Elevation / Scale 1/4"=1'



KEY NOTES:

- A - 8" deep cabinet with routed face backed by acrylic cabinet to be painted to match MP Satin black.
- B - Cabinet to be edge lit bottom and side.
- C - Boarder to be 1/2" thick Acrylic painted to match 3M Red 3630-033

FINISHES:

- 3M Block out black (A)
- 3M Red 3630-033 (A)
- MP Satin Black (C)
- Prefinished black (Trim cap and returns) (A)

CALCULATIONS:

TOTAL AREA:8"SQ
SIGN WEIGHT: 90-115LBS.

Width: 4'-0"
Height: 2'-0"
Area: 8'-0" sq



Scale 1 1/2"=1'

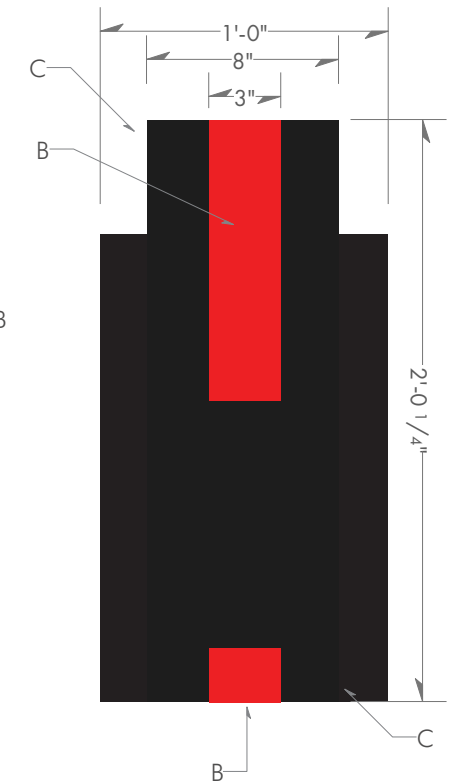

makesignsnotwar.com
325 W Front St, Mount Horeb, WI 53572

CUSTOMER APPROVAL: _____

DATE: _____

LANDLORD APPROVAL: _____

DATE: _____

S H E E T

By signing this approval you are hereby authorizing Sign Art Studio LLC to proceed with the work as described. Any deviation from these specifications will become the customer's financial responsibility.

© The above artwork and or conceptual design, less customer provided artwork or plans, is property of Sign Art Studio and may not be reproduced without written consent .

BI

Secondary Entry : Logo to be face lit channel letters with illuminated inner archway



makesignsnotwar.com
325 W Front St, Mount Horeb, WI 53572

CUSTOMER APPROVAL: _____

DATE: _____

LANDLORD APPROVAL: _____

DATE: _____

S H E E T

By signing this approval you are hereby authorizing Sign Art Studio LLC to proceed with the work as described. Any deviation from these specifications will become the customer's financial responsibility.

© The above artwork and or conceptual design, less customer provided artwork or plans, is property of Sign Art Studio and may not be reproduced without written consent .

BI

Main Entry : Logo to be face lit channel letters with illuminated inner archway

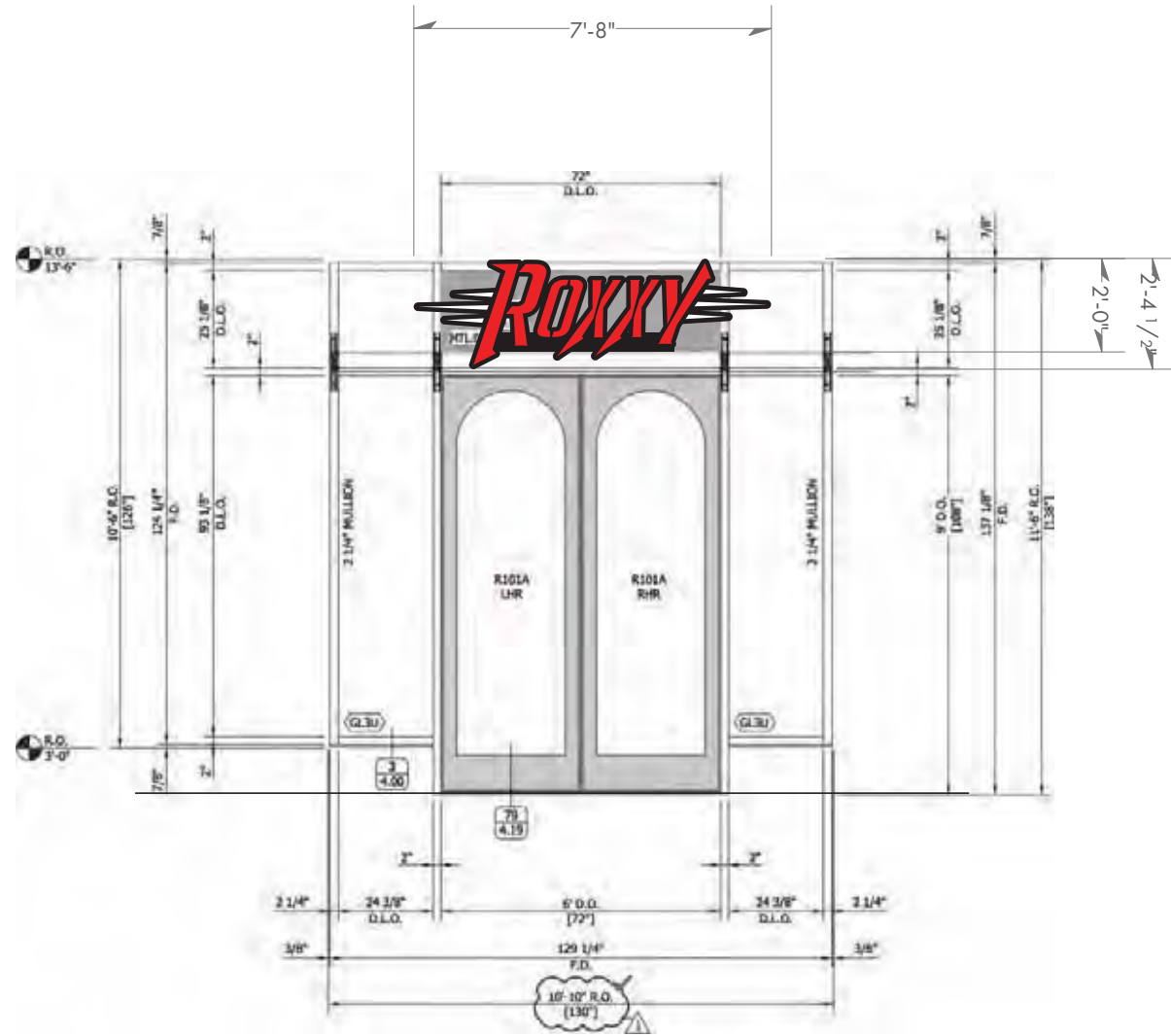

North Elevation / Scale 1/4"=1'

Width: 7'-8"
Height: 2'-5"
Area: 18.527'sq

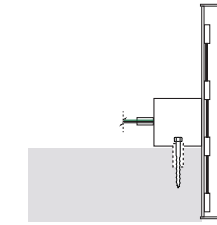
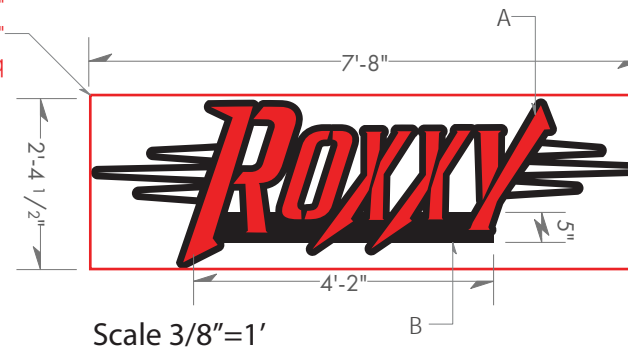

KEY NOTES:

A - 4" deep channel cabinet stock black returns and stock black 1" trim cap. faces to b .177 acrylic with vinyl applied first surface. illuminate with White LED.

B - Raceway to be 5" x 5" aluminum construction Paint to match MP Satin black.

C - Routed face Channel cabinet backed by .177 Whit Acrylic with .063" 4" returns. illuminate with color changing LED.

FINISHES:

- 3M Block out black (A)
- 3M Red 3630-033 (A)
- MP Satin Black (C)
- Prefinished black (Trim cap and returns) (A)

CALCULATIONS:

TOTAL AREA: 18.527' SQ



makesignsnotwar.com
325 W Front St, Mount Horeb, WI 53572

CUSTOMER APPROVAL: _____

DATE: _____

LANDLORD APPROVAL: _____

DATE: _____

S H E E T

By signing this approval you are hereby authorizing Sign Art Studio LLC to proceed with the work as described. Any deviation from these specifications will become the customer's financial responsibility.

© The above artwork and or conceptual design, less customer provided artwork or plans, is property of Sign Art Studio and may not be reproduced without written consent .

CLI

Main Entry: Logo to be face lit channel letters with illuminated inner archway



CUSTOMER APPROVAL: _____

DATE: _____

LANDLORD APPROVAL: _____

DATE: _____

S H E E T

By signing this approval you are hereby authorizing Sign Art Studio LLC to proceed with the work as described. Any deviation from these specifications will become the customer's financial responsibility.

© The above artwork and or conceptual design, less customer provided artwork or plans, is property of Sign Art Studio and may not be reproduced without written consent .

CLI



makesignsnotwar.com
325 W Front St, Mount Horeb, WI 53572

CUSTOMER APPROVAL: _____

DATE: _____

LANDLORD APPROVAL: _____

DATE: _____

By signing this approval you are hereby authorizing Sign Art Studio LLC to proceed with the work as described. Any deviation from these specifications will become the customer's financial responsibility.

© The above artwork and or conceptual design, less customer provided artwork or plans, is property of Sign Art Studio and may not be reproduced without written consent .

S H E E T

BI & CLI

HARMONIC HOSPITALITY GROUP - 02040224 - ROXXY

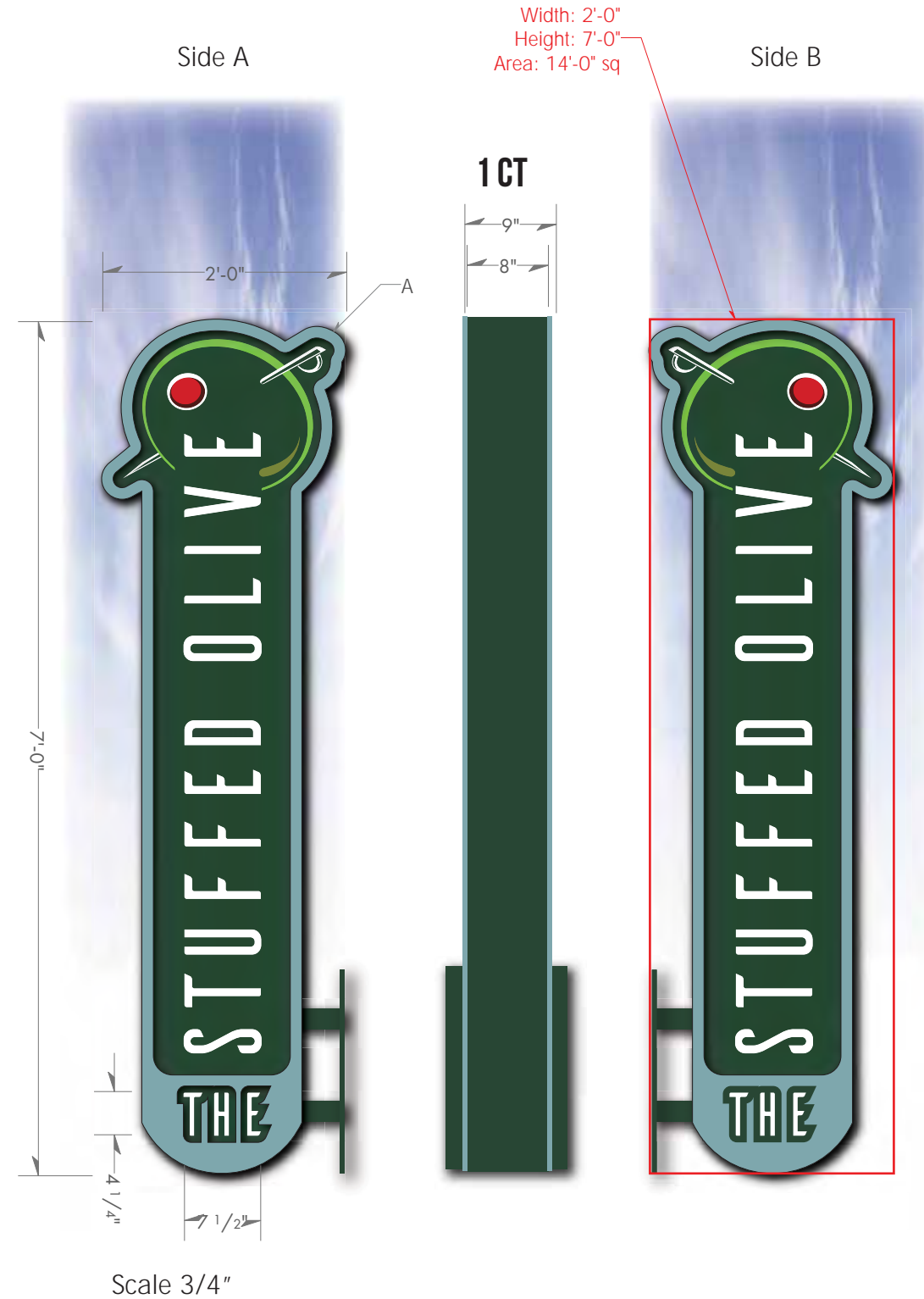
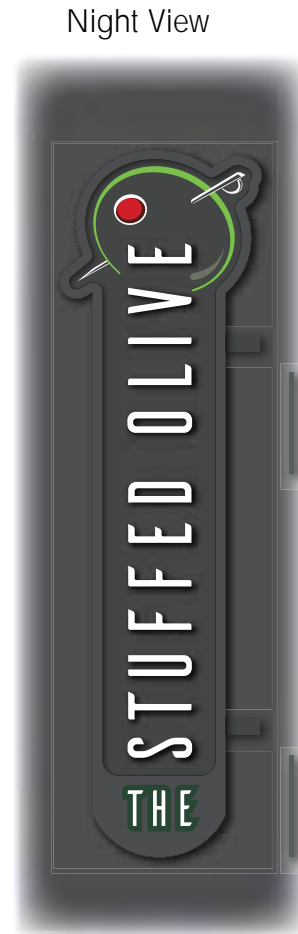
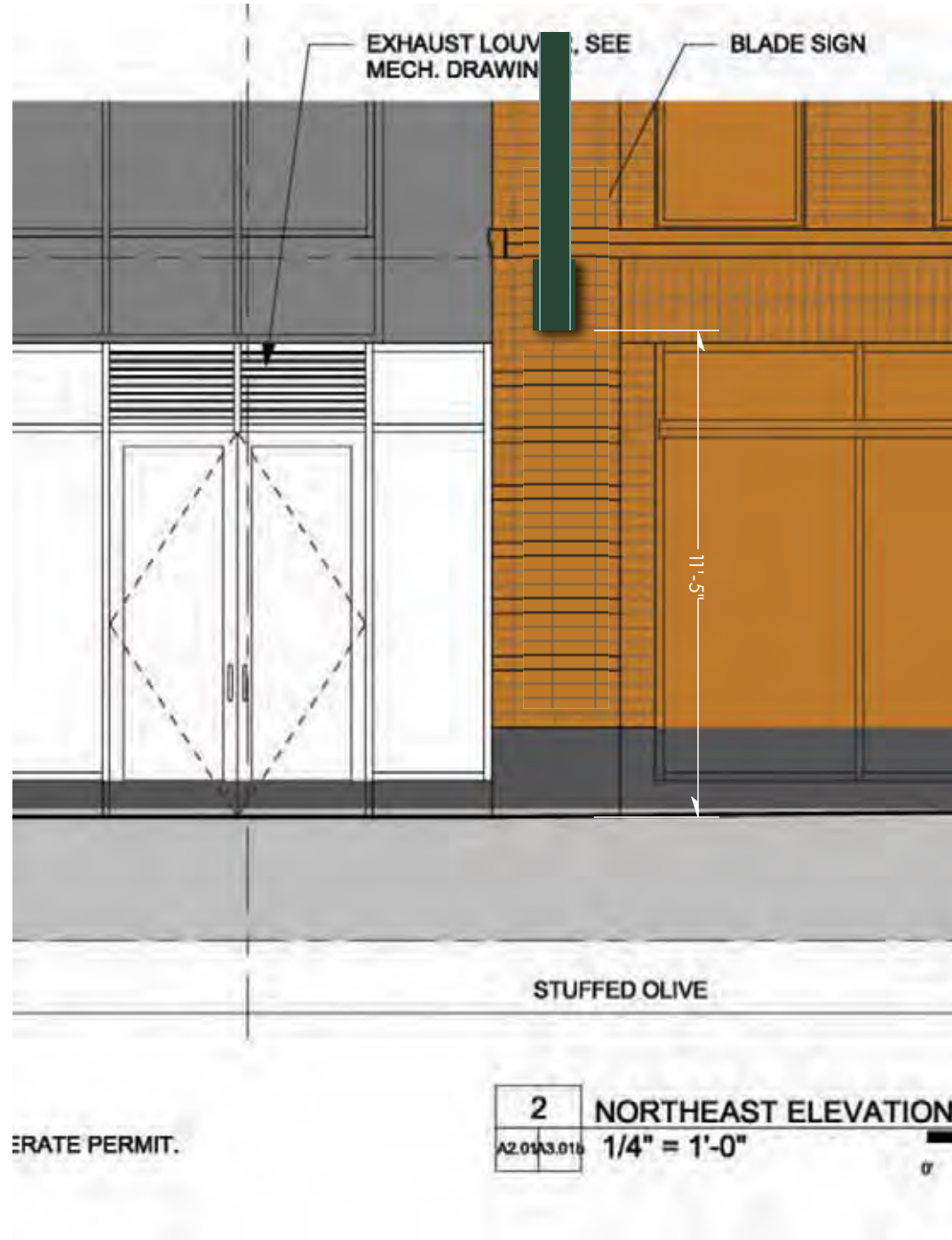

KEY NOTES:
 A -Blade sign aluminum tube frame construction
 Skin with .090 aluminum. Paint satin to match PMS 553C boarder to be 1/2" thick PVC Paint Satin to match 5493C. Face to be routed backed by acrylic. Acrylic to have a digital print applied first surface.

FINISHES:

- Paint satin to match 5493C
- Paint satin to match 553C
- Print to match 7488C
- Print to match 7491C
- Print to match 485C
- Print to match 4625C

CALCULATIONS:
TOTAL AREA: 14'-0" SQ

CUSTOMER APPROVAL: _____	DATE: _____	LANDLORD APPROVAL: _____	DATE: _____	S H E E T
By signing this approval you are hereby authorizing Sign Art Studio LLC to proceed with the work as described. Any deviation from these specifications will become the customer's financial responsibility.				BI
© The above artwork and or conceptual design, less customer provided artwork or plans, is property of Sign Art Studio and may not be reproduced without written consent .				



Night View



KEY NOTES:

A - 1 Channel letters set. Returns to be 4" prefinished White. Trim cap to be 1" Prefinished White. Faces to be routed from .177 White acrylic, Olive to have a digital print applied first surface to the face. Illuminate with white LED

B - 5" x 5" Raceway to be Painted to match Canopy

FINISHES:

- Paint satin to match 553C (A)
- Print to match 7488C (A)
- Print to match 7491C (A)
- Print to match 485C (A)
- Print to match 4625C (A)
- Print to match 560C (A)
- Prefinished White (Returns & trimcap)
- Paint to match canopy (Need color match)

CALCULATIONS:

TOTAL AREA 16.124' SQ

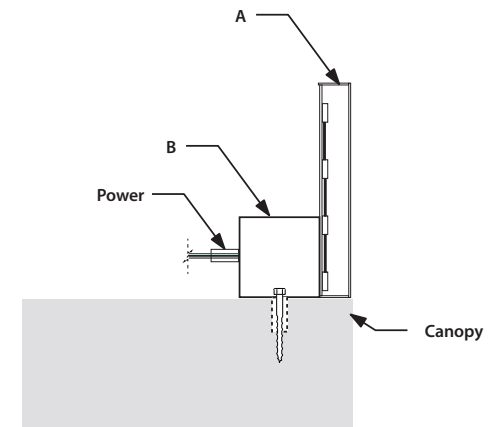
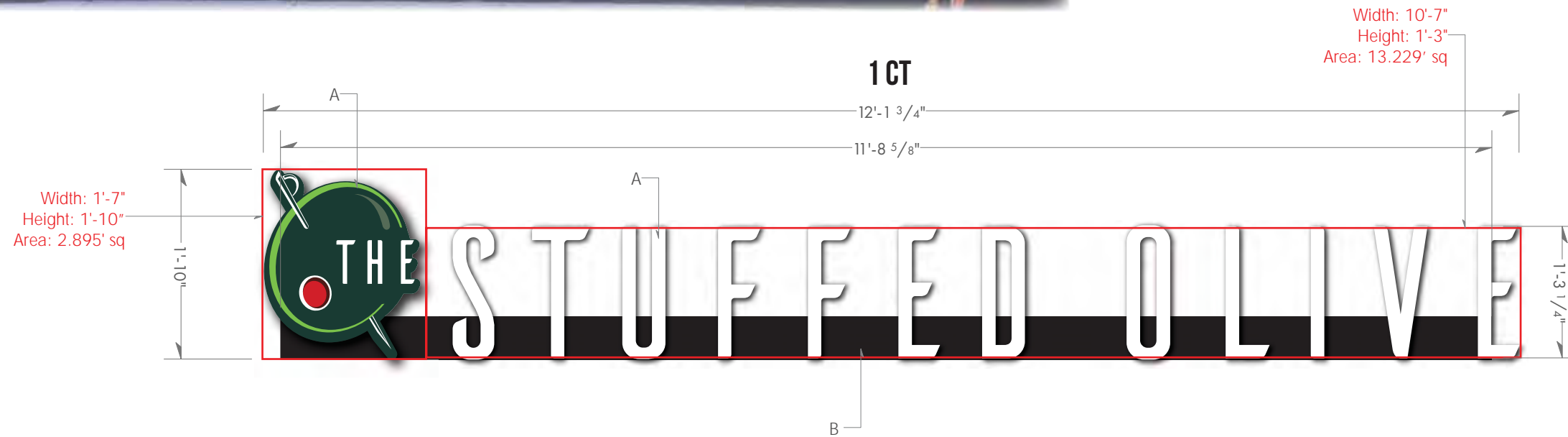

makesignsnotwar.com
325 W Front St, Mount Horeb, WI 53572

CUSTOMER APPROVAL: _____

DATE: _____

LANDLORD APPROVAL: _____

DATE: _____

S H E E T

By signing this approval you are hereby authorizing Sign Art Studio LLC to proceed with the work as described. Any deviation from these specifications will become the customer's financial responsibility.

© The above artwork and or conceptual design, less customer provided artwork or plans, is property of Sign Art Studio and may not be reproduced without written consent .

CLI



makesignsnotwar.com
325 W Front St, Mount Horeb, WI 53572

CUSTOMER APPROVAL: _____	DATE: _____	LANDLORD APPROVAL: _____	DATE: _____	S H E E T
By signing this approval you are hereby authorizing Sign Art Studio LLC to proceed with the work as described. Any deviation from these specifications will become the customer's financial responsibility.				CLI
© The above artwork and or conceptual design, less customer provided artwork or plans, is property of Sign Art Studio and may not be reproduced without written consent .				



makesignsnotwar.com
325 W Front St, Mount Horeb, WI 53572

CUSTOMER APPROVAL: _____	DATE: _____	LANDLORD APPROVAL: _____	DATE: _____	S H E E T
By signing this approval you are hereby authorizing Sign Art Studio LLC to proceed with the work as described. Any deviation from these specifications will become the customer's financial responsibility.				BI
© The above artwork and or conceptual design, less customer provided artwork or plans, is property of Sign Art Studio and may not be reproduced without written consent .				

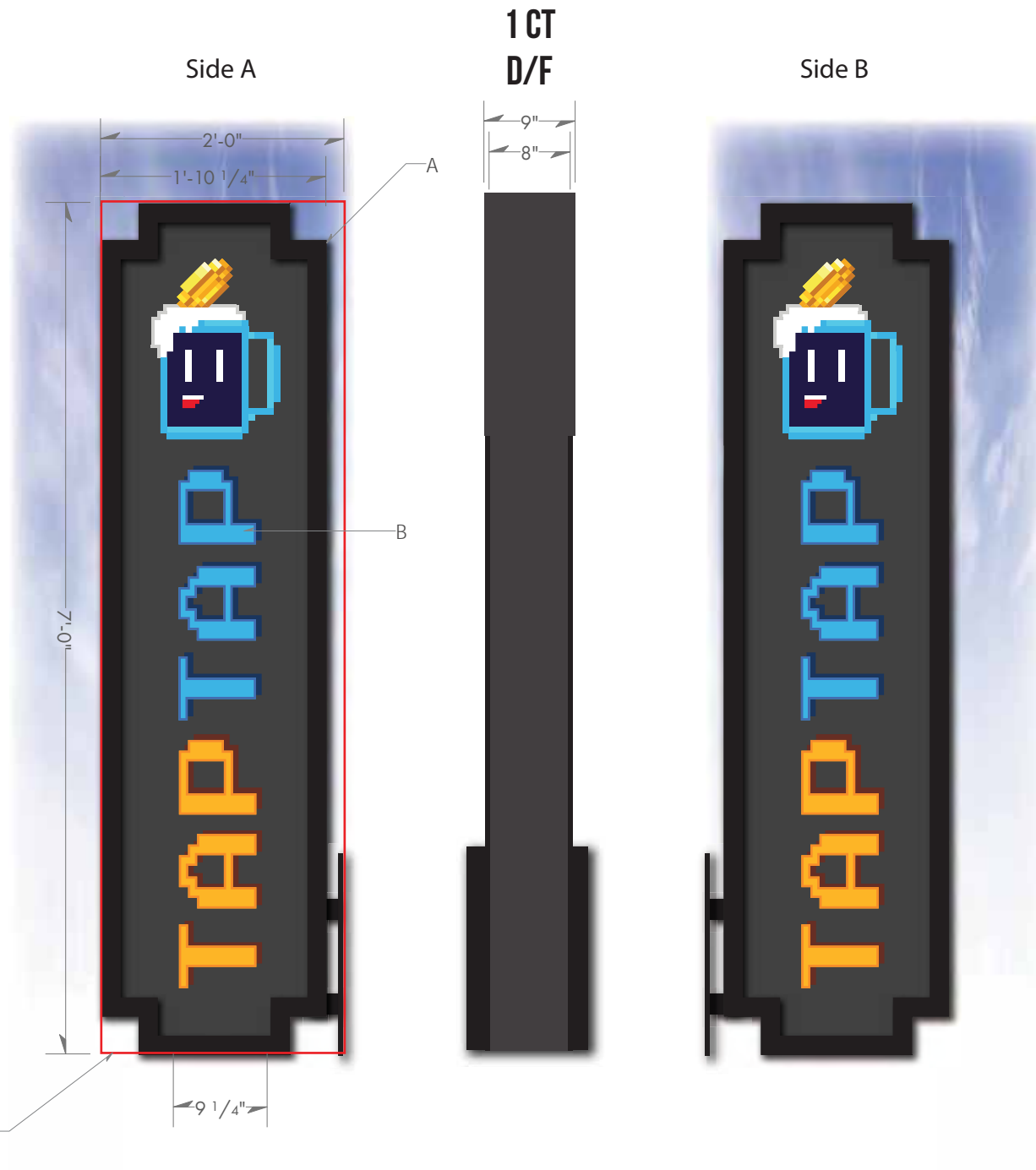

KEY NOTES:

A - BI D/F Cabinet to be Aluminum tube frame construction Skin with .090 Aluminum. Face to be routed face backed by acrylic. Boarder to be cut from 1/2" PVC Paint to match satin black. flush mount to face.

B - Trans Digital print applied first surface to acrylic.

FINISHES:

- PMS 298C
- Print to match PMS 483C
- PMS 534C
- PMS 7683C
- Print to match PMS 715C
- Print to match PMS 1235C
- Print to match PMS 305C
- Print to match PMS 7565C
- Print to match PMS 123C
- Print to match PMS 101C
- Print to match PMS 275C
- Print to match cool grey 2C
- Print to match PMS 185C
- Paint to match Satin MP Black (A)
- Paint to match Satin Draconia MP40821 (A)

CALCULATIONS:

TOTAL AREA: 14' SQ



makesignsnotwar.com
325 W Front St, Mount Horeb, WI 53572

CUSTOMER APPROVAL: _____

DATE: _____

LANDLORD APPROVAL: _____

DATE: _____

By signing this approval you are hereby authorizing Sign Art Studio LLC to proceed with the work as described. Any deviation from these specifications will become the customer's financial responsibility.

© The above artwork and or conceptual design, less customer provided artwork or plans, is property of Sign Art Studio and may not be reproduced without written consent .

S H E E T

BI

Mounting Location / Second canopy in from the left



Night View



KEY NOTES:

A - 1 Set of face lit channel letters. Returns to be .040 aluminum 4" deep prefinished black. Trim cap to be 1" prefinished Black. Faces to be .177 White acrylic. With a die cut digital print applied first surface. Illuminate with white LED

B - 5"x 5"x 6'10 1/2" Raceway Painted to match Satin black

FINISHES:

- PMS 298C
- Print to match PMS 483C
- PMS 534C
- PMS 7683C
- Print to match PMS 715C
- Print to match PMS 1235C
- Print to match PMS 305C
- Print to match PMS 7565C
- Print to match PMS 123C
- Print to match PMS 101C
- Print to match PMS 275C
- Print to match cool grey 2C
- Print to match PMS 185C
- Prefinished black / (Trim cap and returns)
- MP Satin black / (Raceway) (B)

CALCULATIONS:

TOTAL AREA: 8.888' SQ

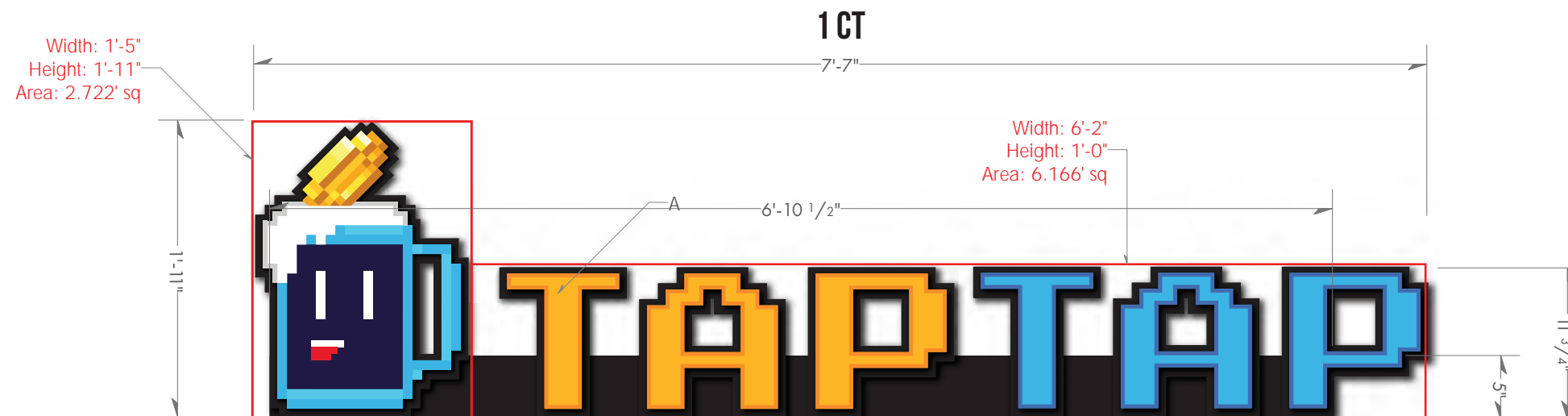

makesignsnotwar.com
325 W Front St, Mount Horeb, WI 53572

CUSTOMER APPROVAL: _____

DATE: _____

LANDLORD APPROVAL: _____

DATE: _____

S H E E T

By signing this approval you are hereby authorizing Sign Art Studio LLC to proceed with the work as described. Any deviation from these specifications will become the customer's financial responsibility.

© The above artwork and or conceptual design, less customer provided artwork or plans, is property of Sign Art Studio and may not be reproduced without written consent .

WLI

EX-01
PROJECTING FACADE BRAND (1/3)

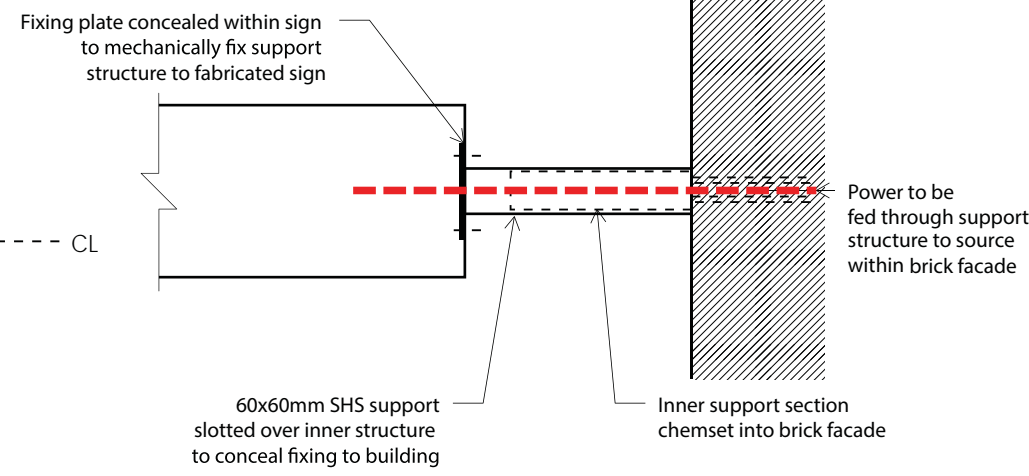
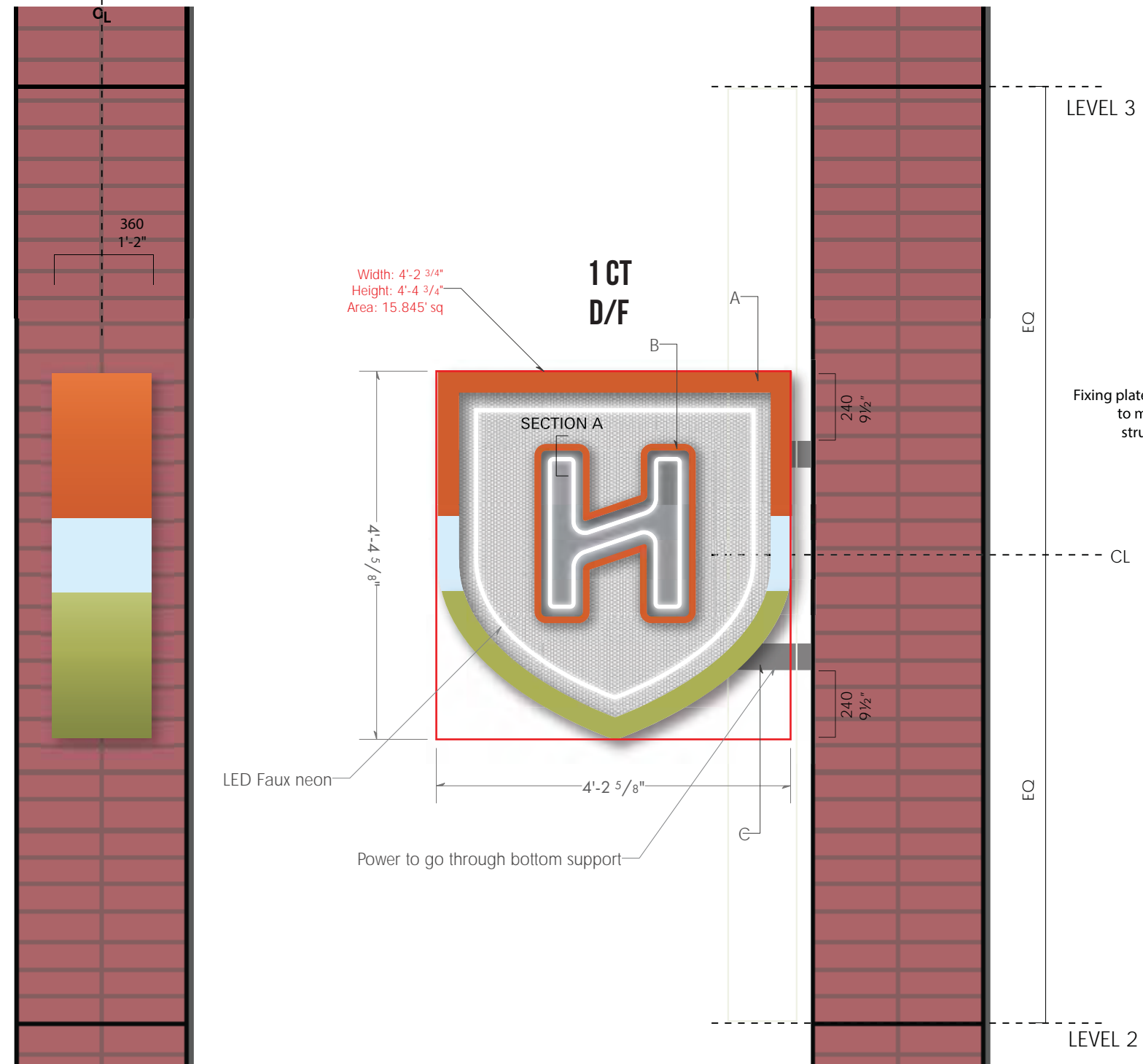

○ SIDE VIEW - CONNECTION DETAIL
1:10 @ A3

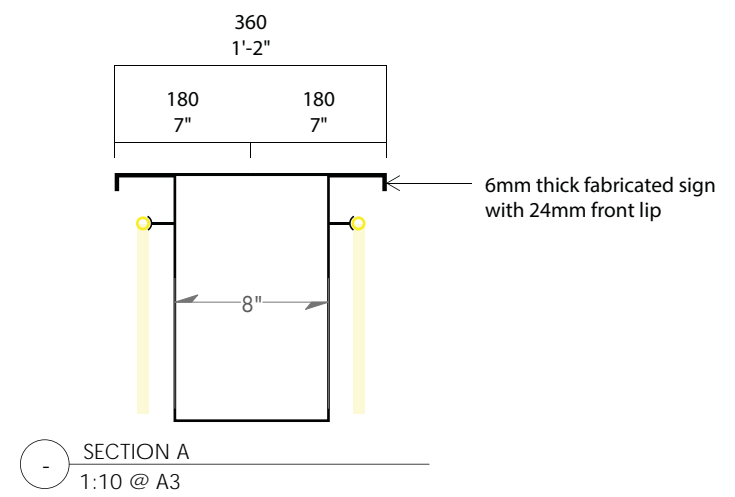

○ SECTION A
1:10 @ A3

KEY NOTES:

A - SPEC:
'Shield' shape:
6mm thick fabricated can sign with aluminum perforated panel .0320" Thick (20 Gauge), 3/16" Round on 1/4" Staggered Centers and internal Faux neon LED illumination to both front and back faces. Exterior and front lip of sign be painted in 3 colors: Orange, Blue & Green, refer to materials page for color specification. Inside faces of sign to be painted gray.

B - 'H' logo:
6mm thick fabricated can letter sign with solid aluminum panel and internal LED Faux neon illumination to both front and back faces. Exterior and front lip of sign be painted in orange, refer to materials page for color specification. Inside faces of sign to be painted gray.

C - Sign to have 60 MM SHS supports with internal sleeve to fix back to brick facade. Signage contractor to provide engineering advice on support structure to ensure viability.

Note: power to neon to be fed through support structure and concealed within interior. all transformers/drivers to be concealed within sign interior.

FINISHES:

- Paint Satin to match PMS 635C
- MP satin to match PMS 167C
- MP satin to match PMS 7744C
- MP satin to match (Need Pantone)
- White LED faux Neon

CALCULATIONS:

AREA 15.845'SQ

○ FRONT VIEW
1:20 @ A3

○ SIDE VIEW
1:20 @ A3



makesignsnotwar.com
325 W Front St, Mount Horeb, WI 53572

CUSTOMER APPROVAL: _____

DATE: _____

LANDLORD APPROVAL: _____

DATE: _____

S H E E T

By signing this approval you are hereby authorizing Sign Art Studio LLC to proceed with the work as described. Any deviation from these specifications will become the customer's financial responsibility.

© The above artwork and or conceptual design, less customer provided artwork or plans, is property of Sign Art Studio and may not be reproduced without written consent .

BI



makesignsnotwar.com
325 W Front St, Mount Horeb, WI 53572

CUSTOMER APPROVAL: _____

DATE: _____

LANDLORD APPROVAL: _____

DATE: _____

S H E E T

By signing this approval you are hereby authorizing Sign Art Studio LLC to proceed with the work as described. Any deviation from these specifications will become the customer's financial responsibility.

© The above artwork and or conceptual design, less customer provided artwork or plans, is property of Sign Art Studio and may not be reproduced without written consent .

BI

CORE SPACES - MADISON OLIV- EXTERIOR - 04040423

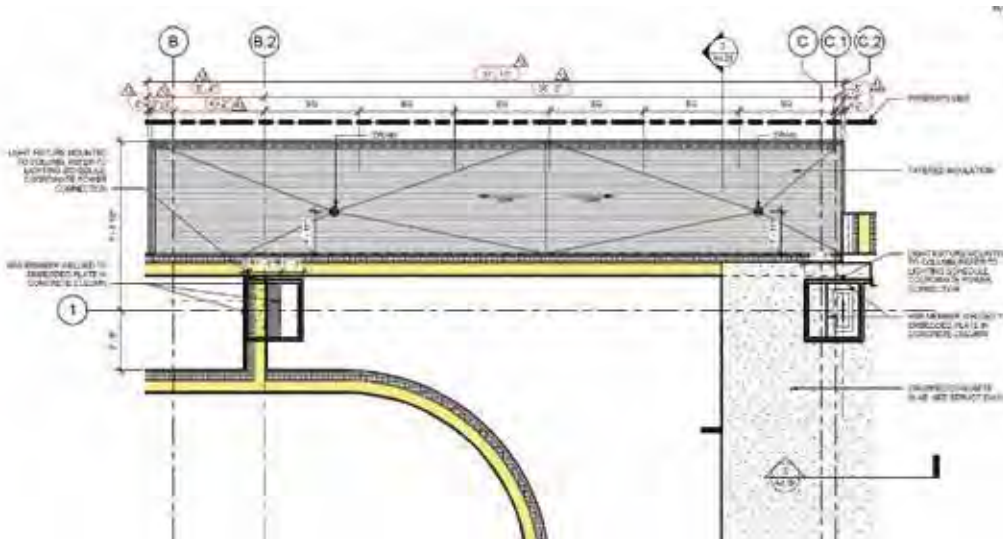

3mm thick fabricated can letters with 16mm front lip

30x40 supports & transformer concealed within false rear of sign

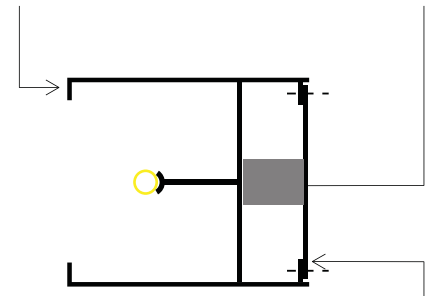

Removable backing to access power & transformer

Night View

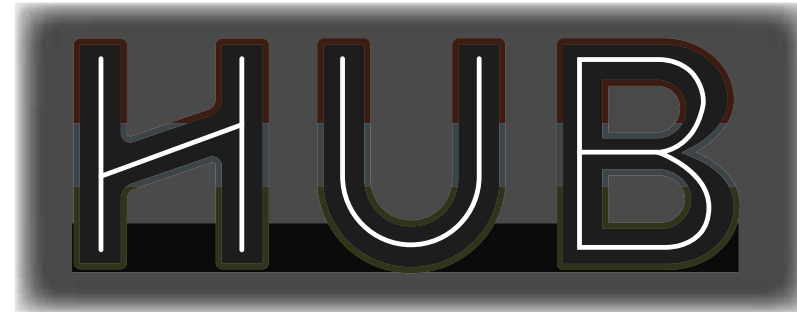

KEY NOTES:

A - SPEC:
3mm thick fabricated can letter sign with internal LED faux neon illumination. Exterior and front lip of sign to be painted in 3 colours: Orange, Blue & Green, refer to materials page for colour specification. Inside faces of sign to be painted grey. Sign to fix directly to awning and fixing to be concealed within false back. Signage contractor to provide engineering advice on support structure to ensure viability. Power to neon to be fed through support structure and concealed within sign interior. All transformers/drivers to be concealed within false back of sign.

Note: Oliv temp canopy sign to be removed and install new HUB sign

FINISHES:

- Paint Satin to match PMS 635C (A)
- MP satin to match PMS 167C (A)
- MP satin to match PMS 7744C (A)
- MP satin black (Raaceway)
- LED Faux Neon

CALCULATIONS:

AREA 11.5'SQ

EX-03
PROJECTING ENTRY SIGN

Width: 5'-9"
Height: 2'-0"
Area: 11.5' sq

SECTION A
1:5 @ A3

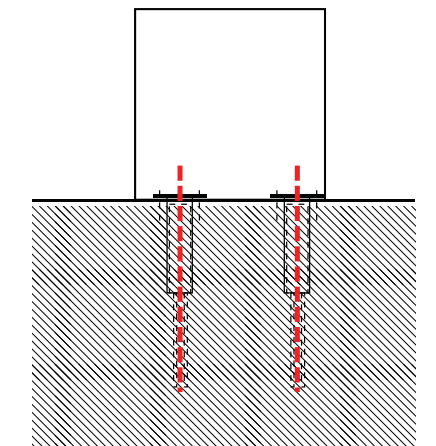
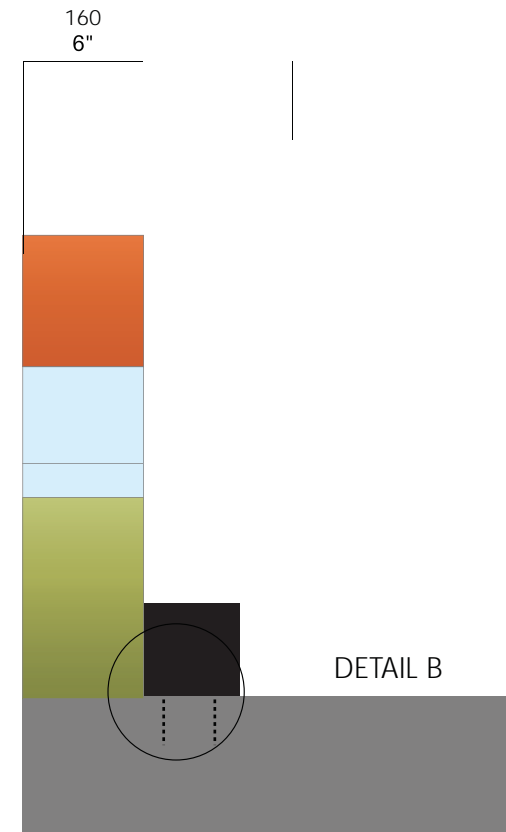
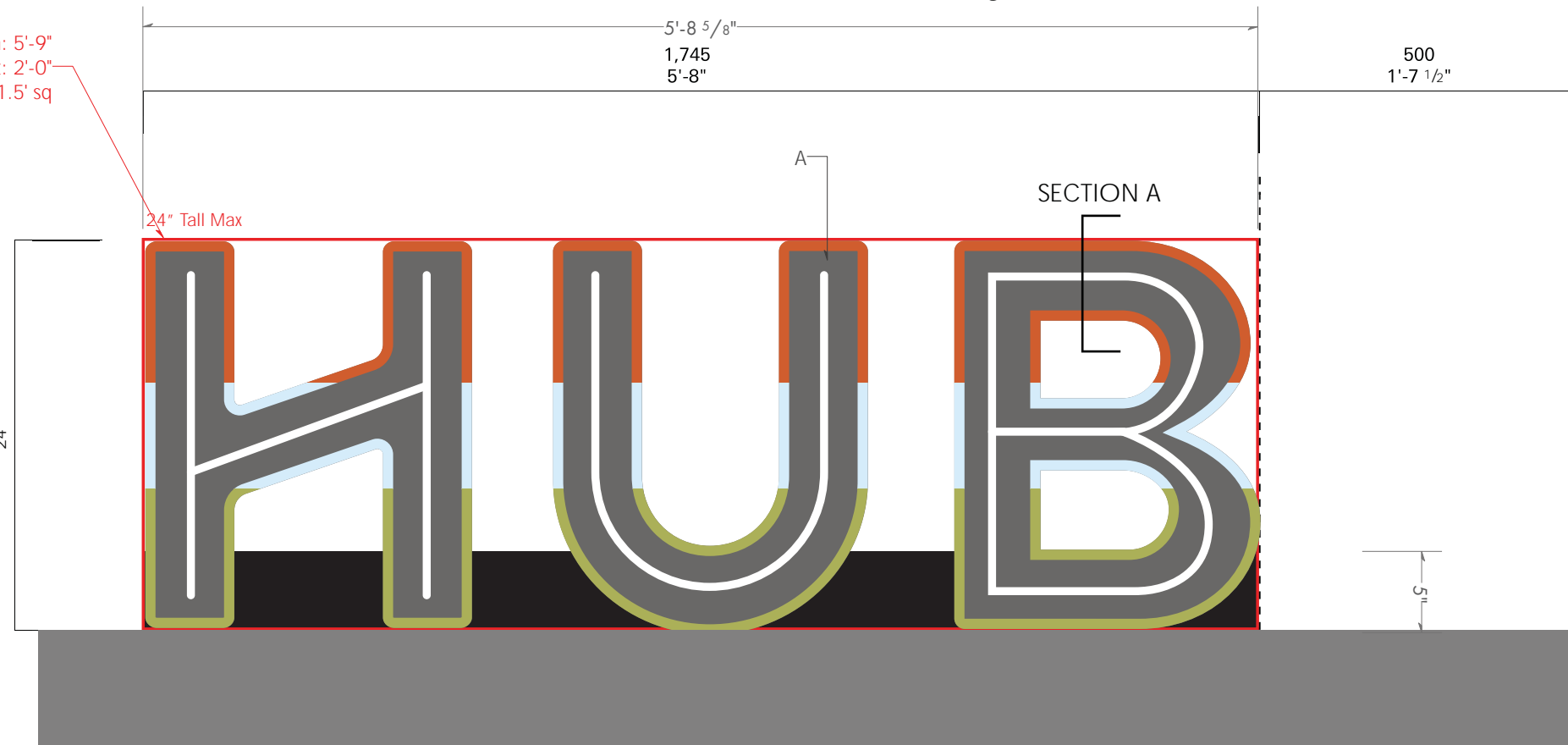

DETAIL B
1:5 @ A3

FRONT VIEW
1:10 @ A3

SIDE VIEW
1:10 @ A3



makesignsnotwar.com
325 W Front St, Mount Horeb, WI 53572

CUSTOMER APPROVAL: _____

DATE: _____

LANDLORD APPROVAL: _____

DATE: _____

By signing this approval you are hereby authorizing Sign Art Studio LLC to proceed with the work as described. Any deviation from these specifications will become the customer's financial responsibility.

© The above artwork and or conceptual design, less customer provided artwork or plans, is property of Sign Art Studio and may not be reproduced without written consent.

S H E E T

CLI

EX-04
PARKING SIGN (1/2)

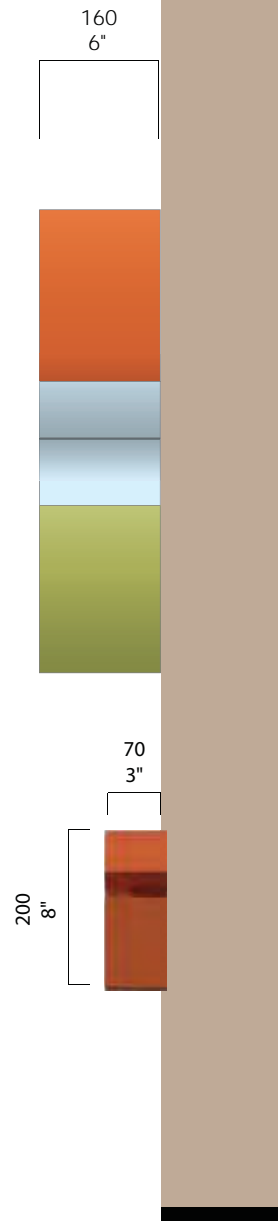

KEY NOTES:
A - SPEC:
HUB Logo: 3mm thick fabricated can letter sign with internal LED Faux neon illumination. Exterior and front lip of sign be painted in 3 colours: Orange, Blue & Green, refer to materials page for colour specification. Inside faces of sign to be painted blue. Sign to have concealed fixings back to brick wall. Signage contractor to provide engineering advice on support structure to ensure viability. Power to LED to be fed through wall. All transformers/drivers to be concealed where possible.
Note: Parking sign is existing

FINISHES:
■ Paint Satin to match PMS 635C
■ MP satin to match PMS 167C
■ MP satin to match PMS 7744C
■ MP satin to match (Need Pantone)
 LED Faux Neon

CALCULATIONS:
BOX 1 AREA 11.395'SQ
BOX 2 AREA 4.44'SQ
TOTAL AREA 17.835'SQ



FRONT VIEW
1:10 @ A3

SIDE VIEW
1:10 @ A3

CUSTOMER APPROVAL: _____ **DATE:** _____ **LANDLORD APPROVAL:** _____ **DATE:** _____

By signing this approval you are hereby authorizing Sign Art Studio LLC to proceed with the work as described. Any deviation from these specifications will become the customer's financial responsibility.

© The above artwork and or conceptual design, less customer provided artwork or plans, is property of Sign Art Studio and may not be reproduced without written consent .

EX-04
PARKING SIGN (2/2)

Width: 25'-9"
Height: 5'-0"
Area: 14.861'sq

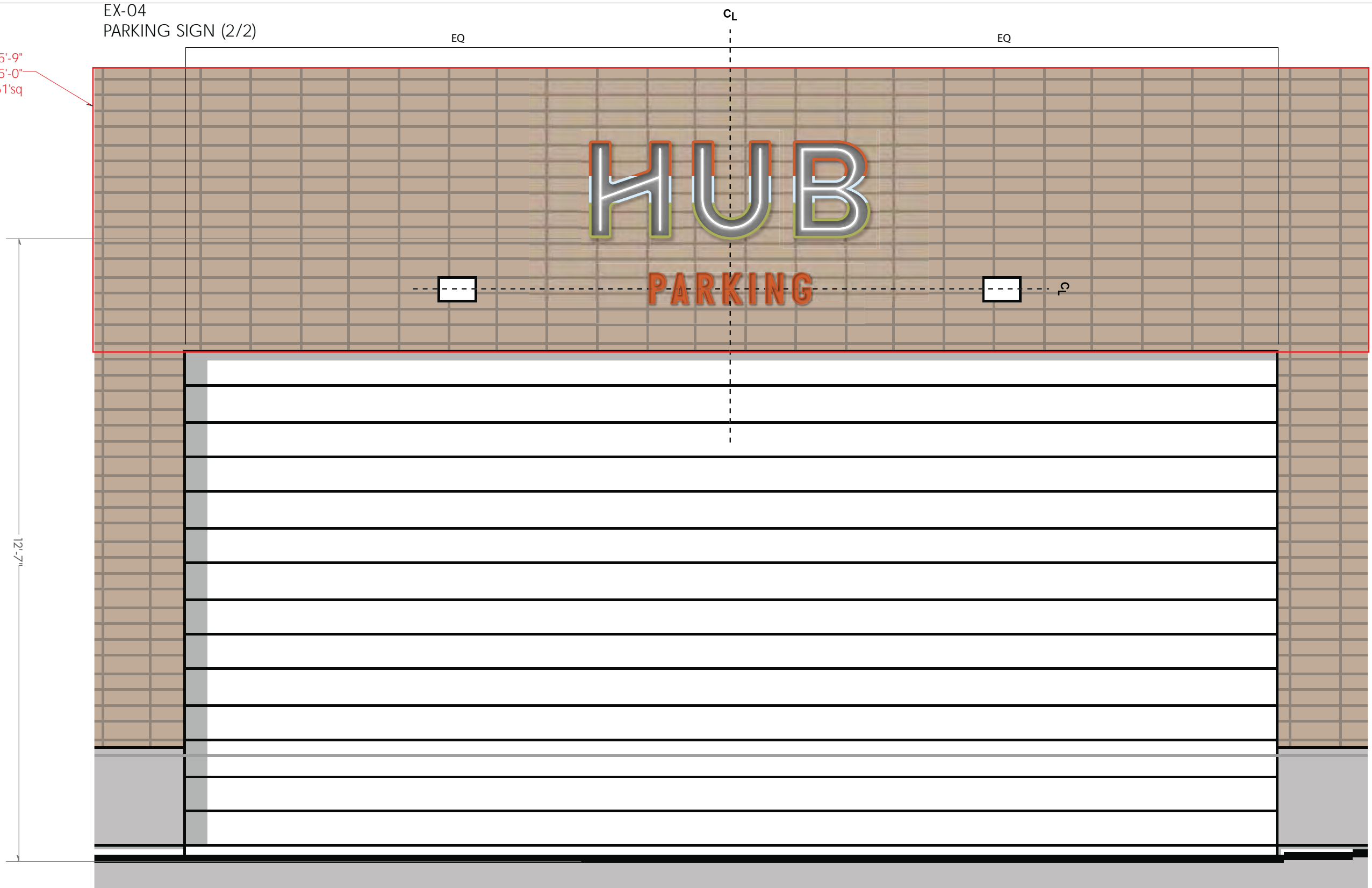

FRONT VIEW
1:25 @ A3



makesignsnotwar.com
325 W Front St, Mount Horeb, WI 53572

CUSTOMER APPROVAL: _____

DATE: _____

LANDLORD APPROVAL: _____

DATE: _____

By signing this approval you are hereby authorizing Sign Art Studio LLC to proceed with the work as described. Any deviation from these specifications will become the customer's financial responsibility.

© The above artwork and or conceptual design, less customer provided artwork or plans, is property of Sign Art Studio and may not be reproduced without written consent .

S H E E T

WLI