

PROPOSED RENOVATION FOR:

RIDGEWOOD POOL

5109 BARTON ROAD
MADISON, WI 53711

PLAN COMMISSION - LAND USE SUBMITTAL

OWNER

RIDGEWOOD POOL, INC.
Barton Road
Madison, WI 53711
ridgewoodpool.com

RIDGEWOOD BUILDING COMMITTEE

Scott Stewart, Chair
Travis Schreiber
Tony Martinelli
John McCartney
Ted Osthelder

RIDGEWOOD FUNDRAISING

ED NEBBINS FOUNDATION
PO Box 930248
Verona, WI 53593-2270
608-571-4524
ednebbinsfoundation.org

DRAWING INDEX

- 1.1 COVER SHEET - INDEX - LOCATION PLAN - TEAM
- 2.1 AERIAL VIEW
- 3.1 EXISTING PHOTOGRAPHS - EXTERIOR
- 3.2 EXISTING PHOTOGRAPHS - INTERIOR
- 4.1 TOPOGRAPHIC/LEGAL SURVEY - FULL
- 4.2 TOPOGRAPHIC/LEGAL SURVEY - BLOW-UP
- 5.1 POOL HOUSE FLOOR FLOOR PLAN
- 5.2 POOL HOUSE ROOF PLAN
- 5.3 POOL HOUSE ELEVATIONS
- 5.4 POOL HOUSE ELEVATIONS
- 5.5 POOL HOUSE ELEVATIONS
- C1.0 EXISTING CONDITIONS PLAN
- C2.0 DEMOLITION PLAN
- C3.0 GRADING AND EROSION CONTROL PLAN
- C4.0 UTILITY PLAN
- C5.0 SITE PLAN
- C6.0 CONSTRUCTION DETAILS
- C6.1 CONSTRUCTION DETAILS
- C6.2 CONSTRUCTION DETAILS
- C6.3 CONSTRUCTION DETAILS
- C6.4 CONSTRUCTION DETAILS
- C6.5 CONSTRUCTION DETAILS
- C7.0 FIRE ACCESS PLAN
- L1.0 LANDSCAPE PLAN
- L2.0 LANDSCAPE ENLARGEMENT
- L2.1 LANDSCAPE ENLARGEMENT
- L3.0 LANDSCAPE DETAILS
- L3.1 LANDSCAPE SCHEDULE AND POINTS SHEET
- E 1.0 SITE LIGHTING
- E 2.0 SITE PHOTOMETRICS

**PROGRESS PLANS
NOT FOR CONSTRUCTION**

SITE INFORMATION

ZONING: SR-C1
 PROPERTY AREA: 118,358 SF
 FRONTAGE: 396' ALONG BARTON ROAD
 SETBACK - NORTH: 30'
 SETBACK - SOUTH: 27.5'
 SETBACK - EAST: 6'
 SETBACK - WEST: 6'
 OPEN SPACE, MIN.: N/A
 BUILDING HEIGHT, MAX.: 35'
 MINIMUM LOT SIZE: 8000 SF
 MINIMUM LOT WIDTH: 60'
 MAX. LOT COVERAGE: 60%
 MAX. BUILDING COVERAGE: 50%
 PARKING - VEHICULAR: BY ZONING ADMINISTRATOR
 PARKING - BICYCLE: BY ZONING ADMINISTRATOR

GENERAL CONTRACTOR

J.H. FINDORFF & SON INC.
300 South Bedford Street
Madison, Wisconsin 53703
Findorff.com
Contact: John Feller

ARCHITECT

BARNETT ARCHITECTURE LLC
118 N. Breese Terrace Suite I
Madison, WI 53726
barnettarchitecture.com
Contact: Todd Barnett, RA ALA

POOL DESIGNER/ENGINEER

RAMAKER ASSOCIATES
855 Community Drive
Sauk City, WI 53583
ramaker.com
Contact: Nick Deines, PE

CIVIL ENGINEER

DC ENGINEERING in collaboration with
CARRICO ENGINEERING
8383 Greenway Blvd., Suite 600
Middleton, WI 53562
dcengineering.net
Contact: Steve Whayland, PE, LEED AP

STRUCTURAL ENGINEER

FINK HOREJSH, LLC
PO Box 52
141 N. Main Street
Monticello, WI 53570
finkhorejsh.com
Contact: Derek Horejsh, PE

LANDSCAPE ARCHITECT

design studio, etc.
330 West Lakeside Street
Madison, WI 53715
Contact: Garret Perry, LA

SURVEYOR

WILLIAMSON SURVEYING AND ASSOCIATES, LLC
104 A West Main Street
Wauwaukee, WI 53597
williamsonsurveying.com
Contact: Noa Prieve, RLS

SOILS TESTING

CGC, INC.
2921 Perry Street
Madison, WI 53713
cgc.net
Contact: Tim Gassenheimer, PE

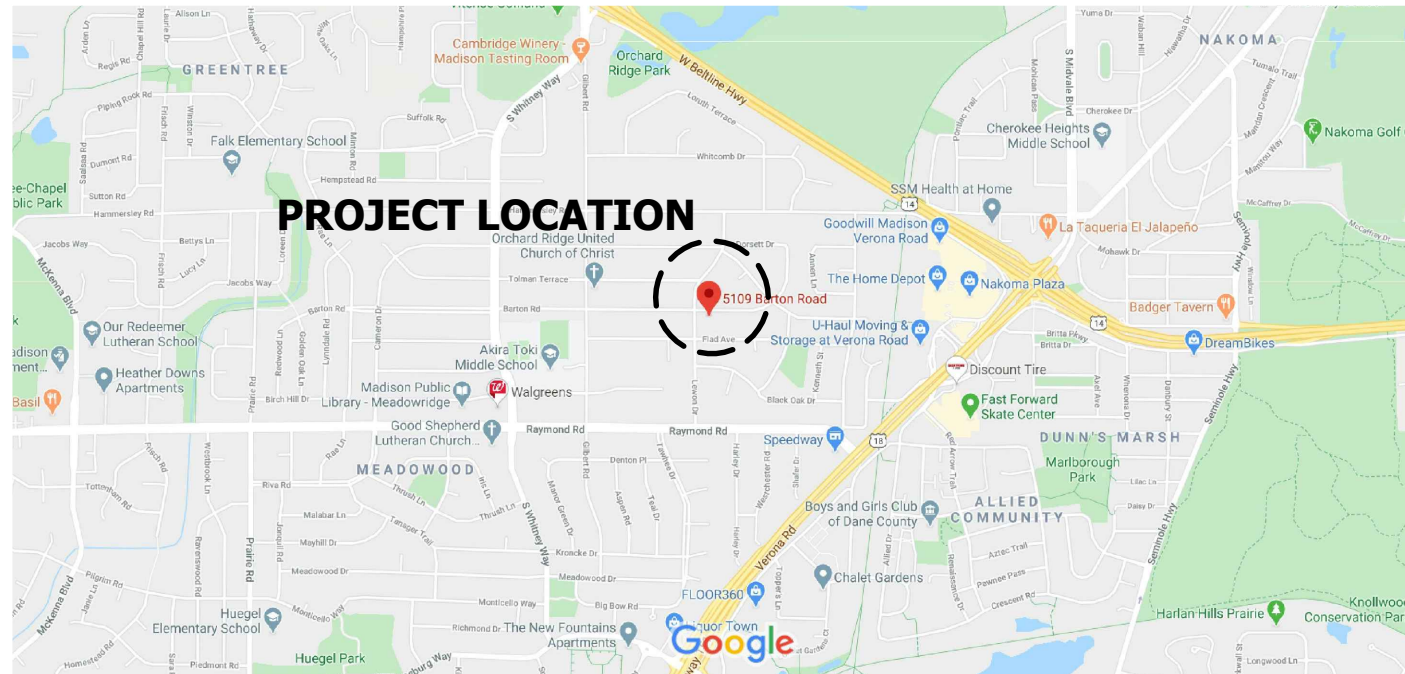

LOCATION MAP



Barnett Architecture

118 NORTH BREESE TERRACE
SUITE I
MADISON, WISCONSIN 53726
608.233.4538
barnettarchitecture.com

PROPOSED RENOVATION

RIDGEWOOD POOL

5109 BARTON ROAD
MADISON, WI 53711



PROGRESS PLANS NOT FOR CONSTRUCTION

DRAWING ISSUE DATES
3-14-2022

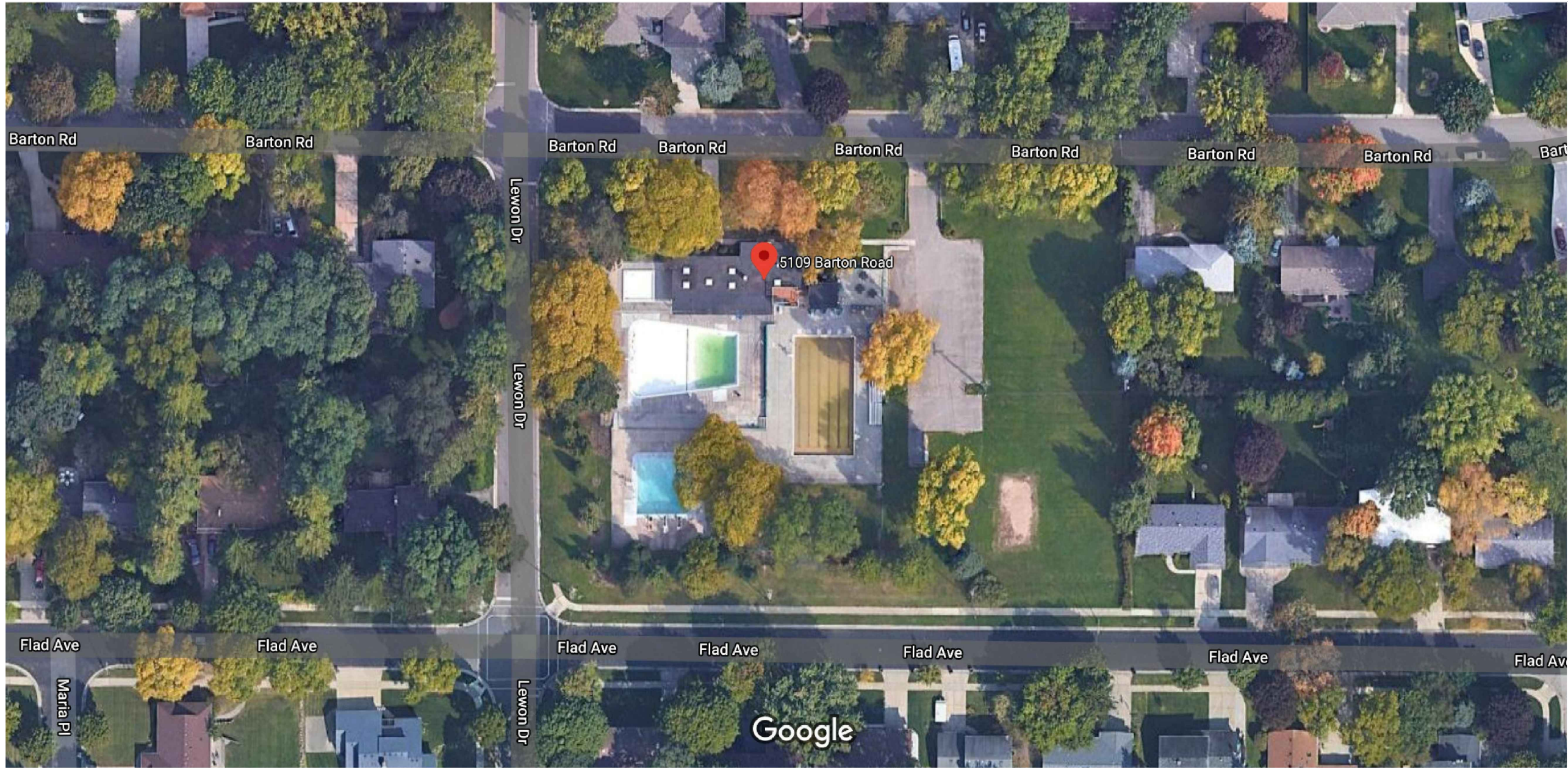

AERIAL



Barnett Architecture

118 NORTH BREESE TERRACE
SUITE I
MADISON, WISCONSIN 53726
608.233.4538
barnettarchitecture.com

PROPOSED RENOVATION

RIDGEWOOD POOL

5109 BARTON ROAD
MADISON, WI 53711



**PROGRESS PLANS
NOT FOR CONSTRUCTION**

DRAWING ISSUE DATES
3-14-2022



POOL HOUSE FROM NORTH-WEST

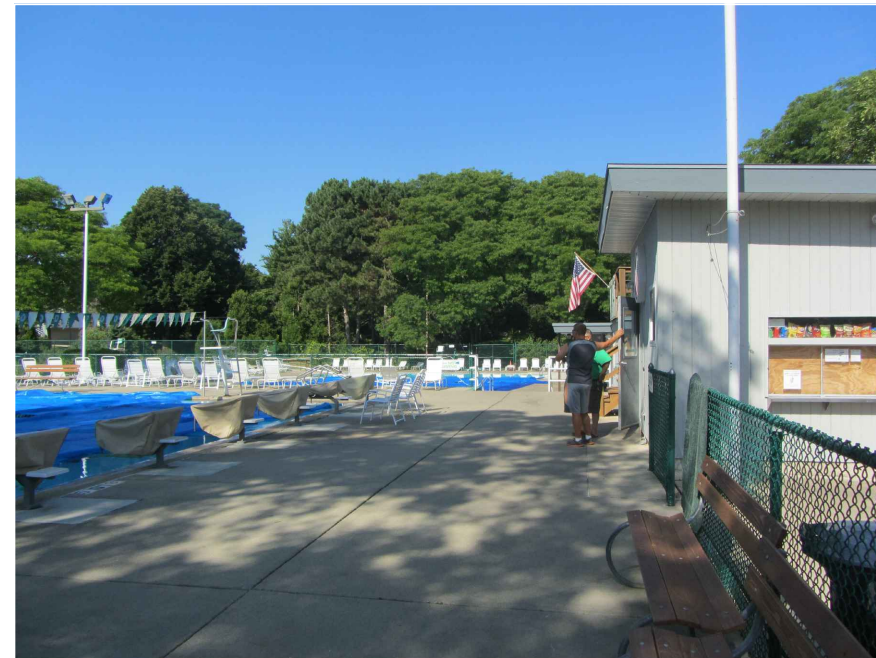

POOL DECK AND POOL HOUSE FROM EAST



DIVING VESSEL FROM WEST



Barnett Architecture

118 NORTH BREESE TERRACE
SUITE I
MADISON, WISCONSIN 53726
608.233.4538
barnettarchitecture.com

PROPOSED RENOVATION

RIDGEWOOD POOL
5109 BARTON ROAD
MADISON, WI 53711

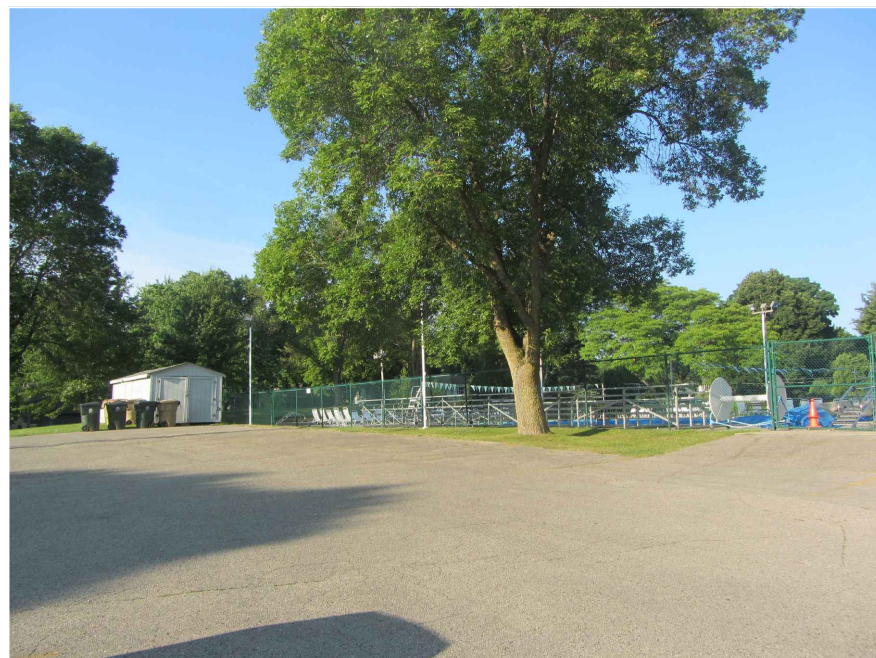

PARKING LOT FROM NORTH-EAST



POOL DECK AND POOL HOUSE FROM EAST



POOL DECK FROM SOUTH-EAST

**PROGRESS PLANS
NOT FOR CONSTRUCTION**

DRAWING ISSUE DATES
3-14-2022

EXISTING CONDITIONS

This document contains confidential or proprietary information. Neither this document nor the information contained herein is to be used or disclosed either in whole or in part, except as authorized.



POOL HOUSE - GUARD ROOM



POOL HOUSE - LOCKER ROOM

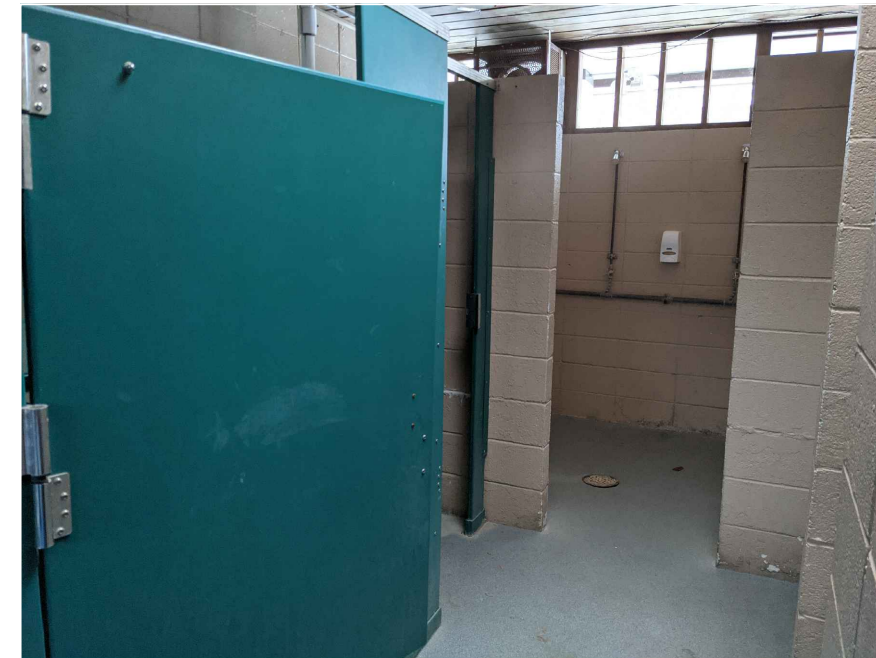

POOL HOUSE - LOCKER ROOM



POOL HOUSE - OFFICE

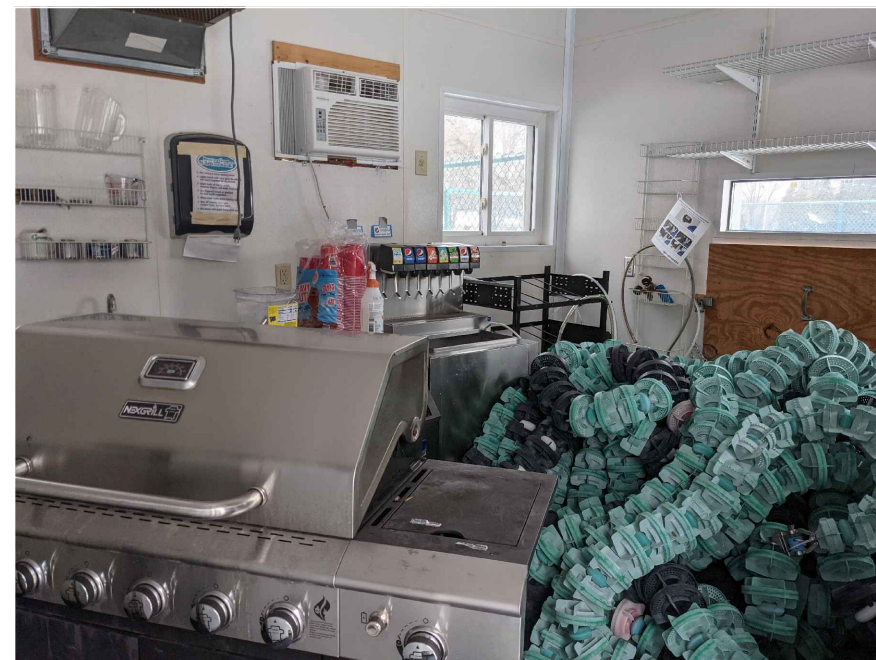

POOL HOUSE - SNACK ROOM

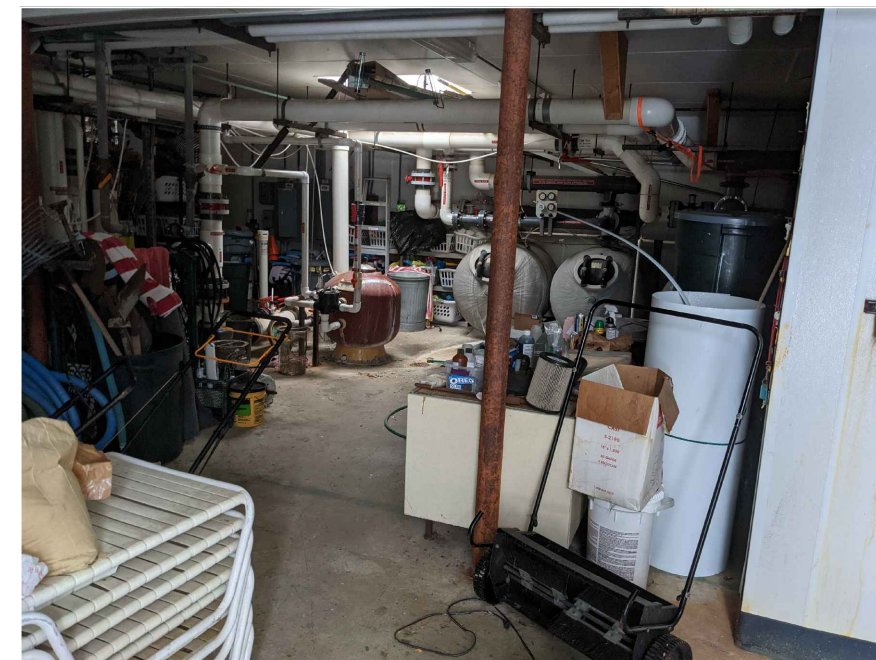

POOL HOUSE - EQUIPMENT ROOM



Barnett Architecture

118 NORTH BREESE TERRACE
SUITE I
MADISON, WISCONSIN 53726
608.233.4538
barnettarchitecture.com

PROPOSED RENOVATION

RIDGEWOOD POOL
5109 BARTON ROAD
MADISON, WI 53711



EXISTING CONDITIONS

This document contains confidential or proprietary information. Neither this document nor the information contained herein is to be used or disclosed either in whole or in part, except as authorized.

**PROGRESS PLANS
NOT FOR CONSTRUCTION**

DRAWING ISSUE DATES
3-14-2022



Barnett Architecture

118 NORTH BREESE TERRACE
SUITE I
MADISON, WISCONSIN 53726
608.233.4538
barnettarchitecture.com

PROPOSED RENOVATION

RIDGEWOOD POOL
5109 BARTON ROAD
MADISON, WI 53711



**PROGRESS PLANS
NOT FOR CONSTRUCTION**

DRAWING ISSUE DATES
3-14-2022

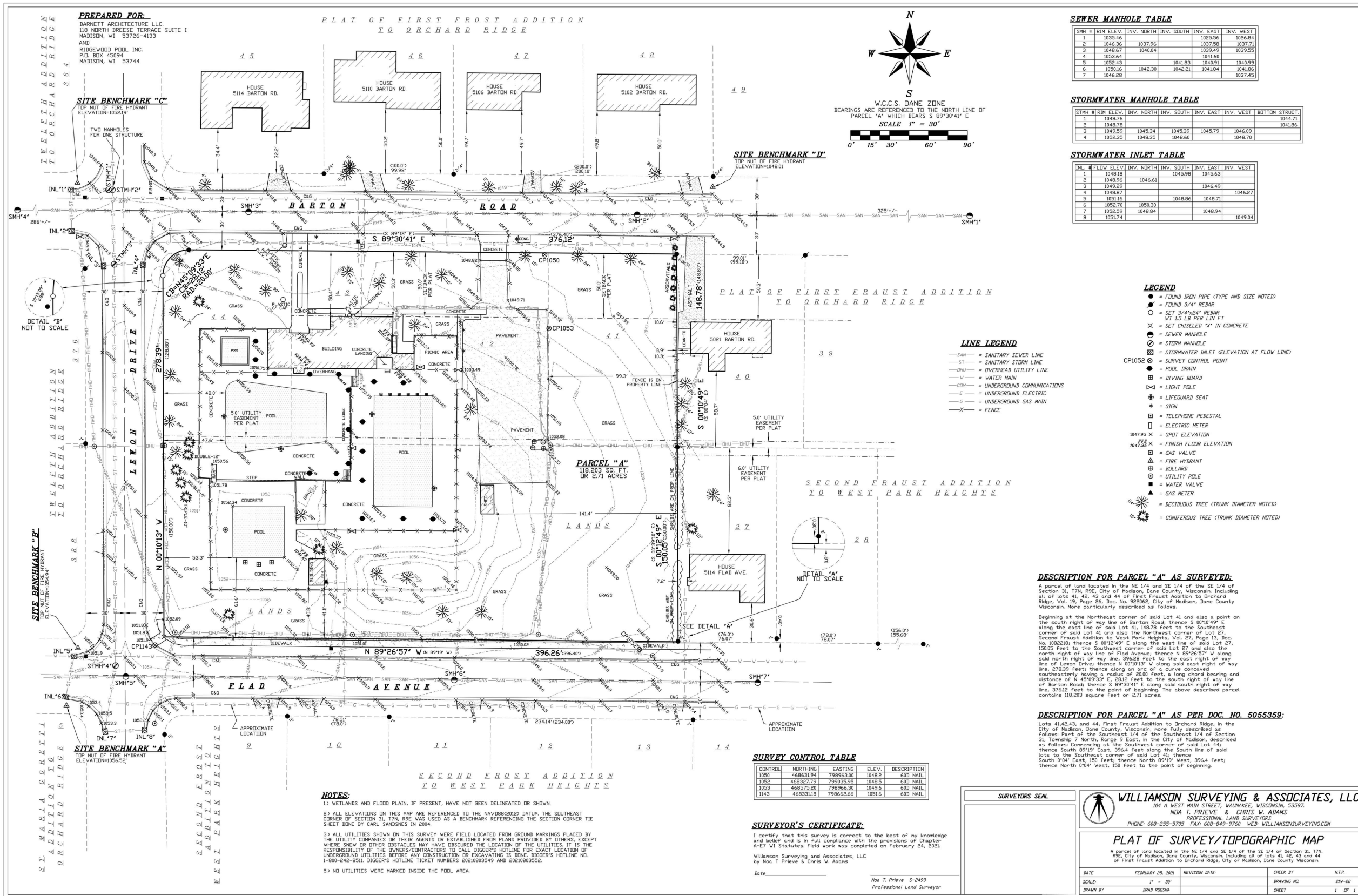

1 SURVEY

1"=80'-0" @ 11" x17"

This document contains confidential or proprietary information. Neither this document nor the information contained herein is to be used or disclosed either in whole or in part, except as authorized.

4.1



Barnett Architecture

118 NORTH BREEZE TERRACE
SUITE I
MADISON, WISCONSIN 53726
608.233.4538
barnettarchitecture.com

PROPOSED RENOVATION

RIDGEWOOD POOL

5109 BARTON ROAD
MADISON, WI 53711



**PROGRESS PLANS
NOT FOR CONSTRUCTION**

DRAWING ISSUE DATES
3-14-2022

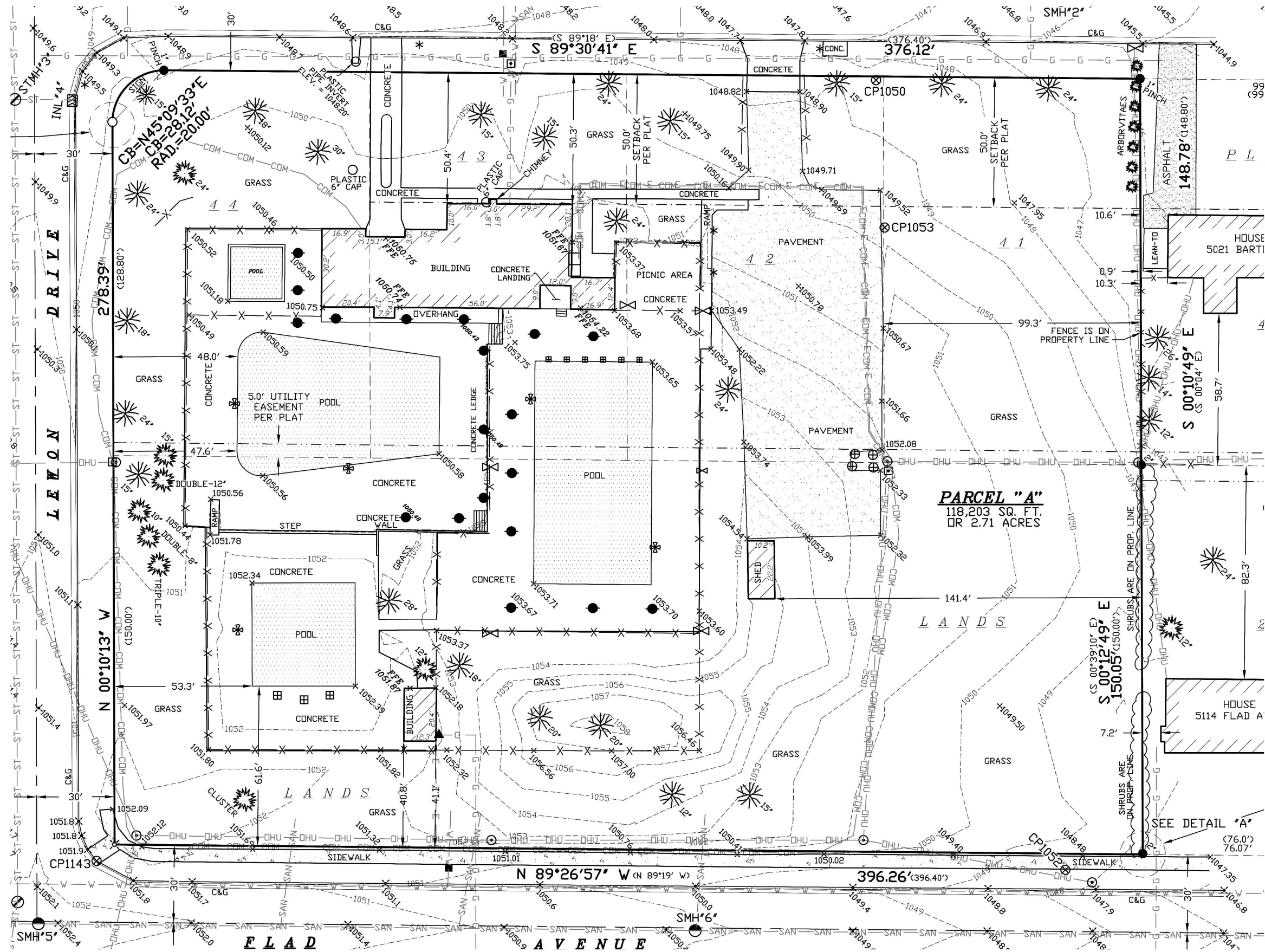

1 SURVEY - SITE PROPER

SCALE: 1" = 80'-0" @ 11" X 17"

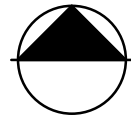
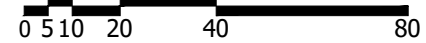

N - plan

This document contains confidential or proprietary information. Neither this document nor the information contained herein is to be used or disclosed either in whole or in part, except as authorized.



Barnett Architecture

118 NORTH BREEZE TERRACE
SUITE I
MADISON, WISCONSIN 53726
608.233.4538
barnettarchitecture.com

PROPOSED RENOVATION

RIDGEWOOD POOL
5109 BARTON ROAD
MADISON, WI 53711



**PROGRESS PLANS
NOT FOR CONSTRUCTION**

DRAWING ISSUE DATES
3-14-2022

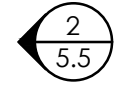
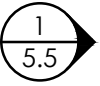
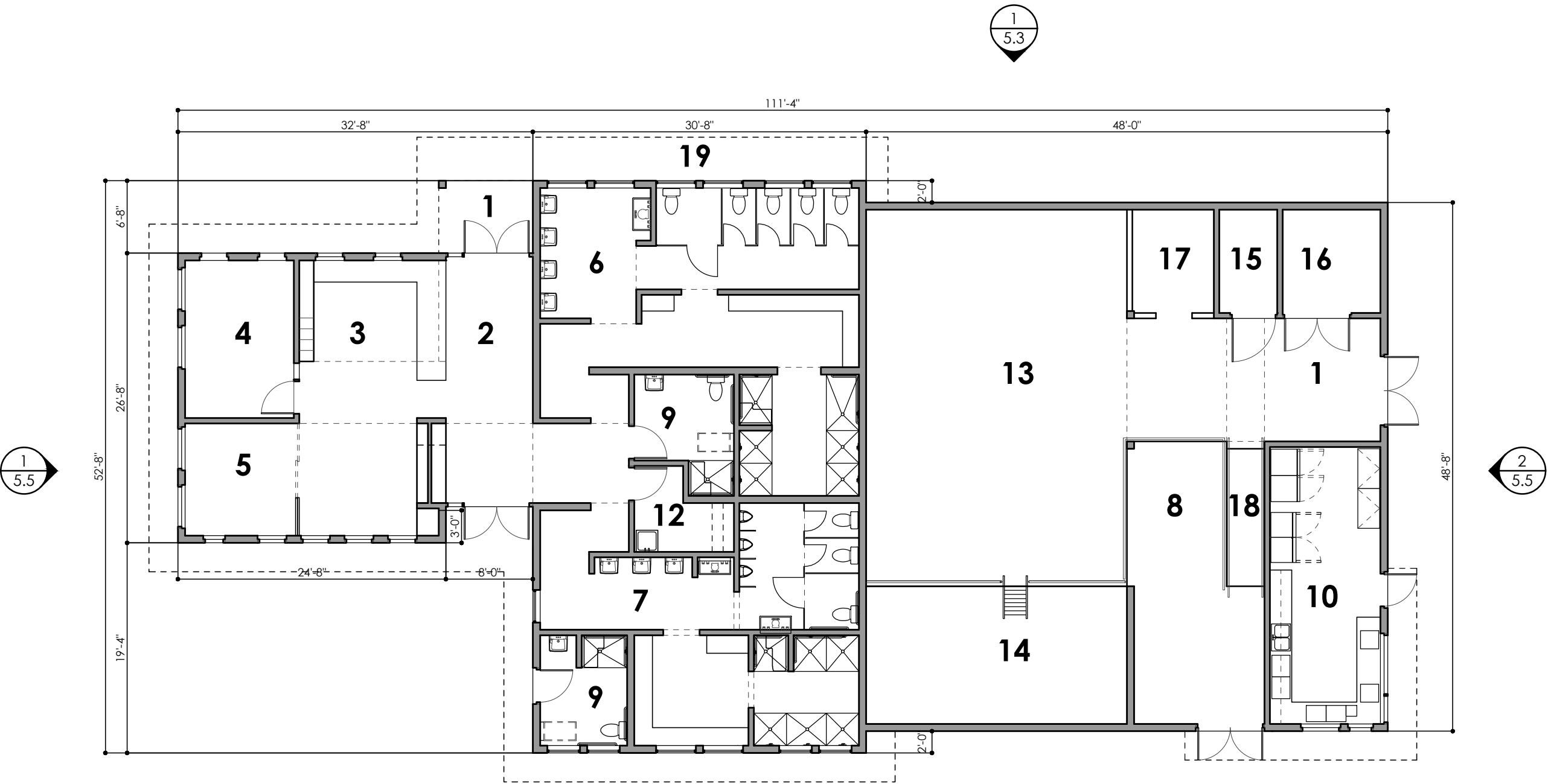

N - plan

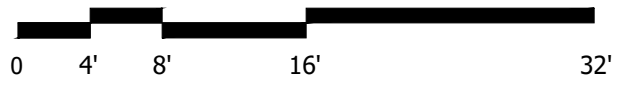

1 POOL HOUSE PLAN

SCALE: 3/32" = 1'-0" @ 11"x17"

LEGEND

- | | |
|-------------------|-----------------------|
| 1 COVERED ENTRY | 11 MECHANICAL |
| 2 ENTRY | 12 JANITOR |
| 3 GUARD | 13 POOL MECHANICAL |
| 4 COACH | 14 POOL EQUIPMENT PIT |
| 5 MANAGER | 15 CHLORINE |
| 6 WOMEN | 16 ACID |
| 7 MEN | 17 WORK AREA |
| 8 STORAGE | 18 RAMP |
| 9 FAMILY RESTROOM | 19 FRONT PORCH |
| 10 SNACK SHACK | |

This document contains confidential or proprietary information. Neither this document nor the information contained herein is to be used or disclosed either in whole or in part, except as authorized.



Barnett Architecture

118 NORTH BREESE TERRACE
SUITE I
MADISON, WISCONSIN 53726
608.233.4538
barnettarchitecture.com

PROPOSED RENOVATION

RIDGEWOOD POOL

5109 BARTON ROAD
MADISON, WI 53711



**PROGRESS PLANS
NOT FOR CONSTRUCTION**

DRAWING ISSUE DATES
3-14-2022

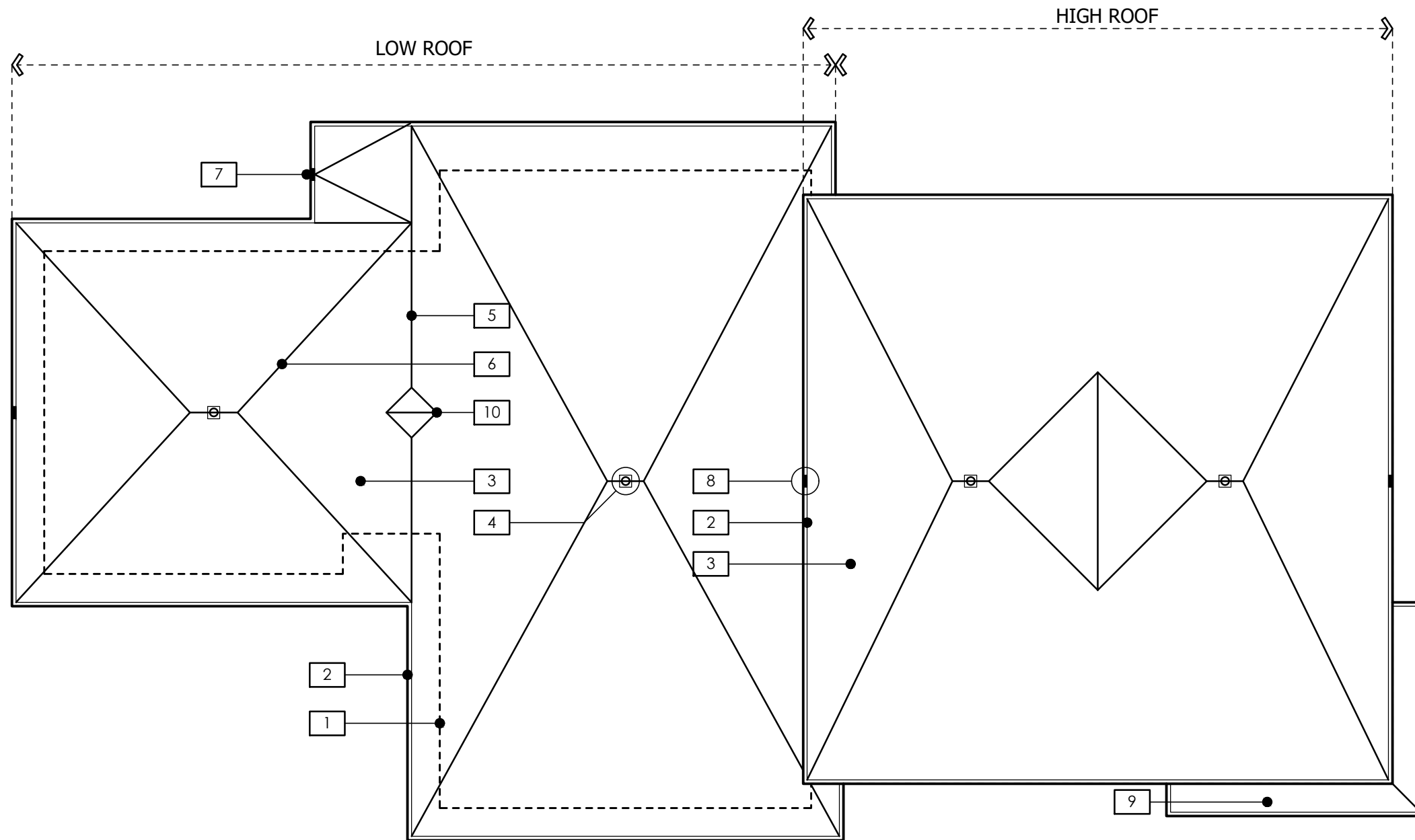

NOTES

1. LINE OF WALL BELOW.
2. ROOF EDGE/METAL CAP.
3. FULLY ADHERED, SINGLE-PL 60 MIL. EPDM Y ROOF MEMBRANE.
4. ROOF DRAIN.
5. RIDGE.
6. VALLEY.
7. ACTIVE SCUPPER
8. OVERFLOW SCUPPER.
9. LOW ROOF AT SNACK SHACK (SELF-DRAINING AT EDGE).
10. OVERFLOW VALLEY.

1 POOL HOUSE ROOF

SCALE: 3/32" = 1'-0" @ 11"x17"



This document contains confidential or proprietary information. Neither this document nor the information contained herein is to be used or disclosed either in whole or in part, except as authorized.

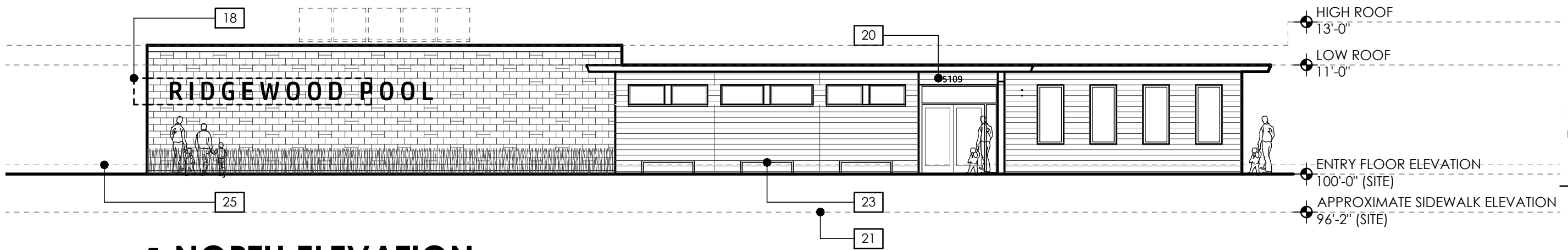

1 NORTH ELEVATION

SCALE: 3/32"=1'-0" @ 11"x17"



Barnett Architecture

118 NORTH BREESE TERRACE
SUITE I
MADISON, WISCONSIN 53726
608.233.4538
barnettarchitecture.com

PROPOSED RENOVATION

RIDGEWOOD POOL

5109 BARTON ROAD
MADISON, WI 53711



KEYED NOTES

1. ENGINEERED WOOD LAP SIDING.
2. ENGINEERED WOOD TRIM/PANEL.
3. 8X8X16 CONCRETE MASONRY UNIT "BRICKS" (WITH OPTIONAL ACCENTS AS SHOWN).
4. EXPOSED CONCRETE CURB AT BASE OF WALL.
5. ENGINEERED WOOD TRIM FASCIA.
6. BRAKE-METAL SIDING CORNER/DIVIDER STRIP.
7. METAL COPING.
8. FIBERGLASS WINDOW.
9. ALUMINUM STOREFRONT AND WINDOW SYSTEM.
10. SCREENED OPENINGS SET IN FRAME/STOPS.
11. EXPOSED ENTRY STEEL COLUMN AND BEAM.
12. ALUMINUM SERVING WINDOW.
13. METAL SERVICE DOOR.
14. BRAKE-METAL FLASHING/CAP AT IRREGULAR DOOR HEAD/CONCRETE MASONRY UNIT COURSING.
15. SNACK SHACK ROOF ELEMENT.
16. LOUVER/GRILLE. LOCATIONS TO BE DETERMINED.
17. SKYLIGHTS BEYOND.
18. BUILDING SIGN (FLOATING ELEMENT AS OPTION). NOTE: SIGNAGE WILL NOT HAVE INTEGRAL LIGHTING.
19. ACCENT SIGN.
20. STREET NUMBER.
21. APPROXIMATE SIDEWALK ELEVATION.
22. (FUTURE) SOLAR PANELS.
23. (FUTURE) BENCHES.
24. CHAIN LINK FENCE.

**PROGRESS PLANS
NOT FOR CONSTRUCTION**

DRAWING ISSUE DATES
3-14-2022



5.3

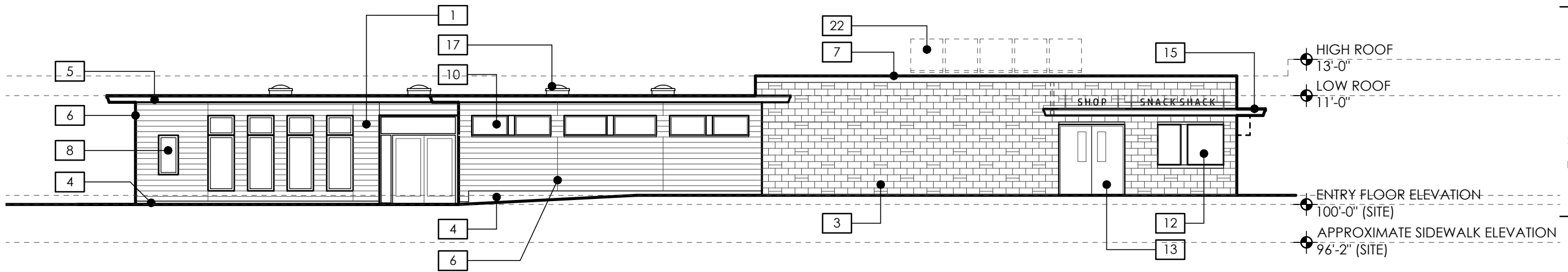

1 SOUTH ELEVATION

SCALE: 3/32"=1'-0" @ 11"x17"



Barnett Architecture

118 NORTH BREESE TERRACE
SUITE I
MADISON, WISCONSIN 53726
608.233.4538
barnettarchitecture.com

PROPOSED RENOVATION

RIDGEWOOD POOL

5109 BARTON ROAD
MADISON, WI 53711



KEYED NOTES

1. ENGINEERED WOOD LAP SIDING.
2. ENGINEERED WOOD TRIM/PANEL.
3. 8X8X16 CONCRETE MASONRY UNIT "BRICKS" (WITH OPTIONAL ACCENTS AS SHOWN).
4. EXPOSED CONCRETE CURB AT BASE OF WALL.
5. ENGINEERED WOOD TRIM FASCIA.
6. BRAKE-METAL SIDING CORNER/DIVIDER STRIP.
7. METAL COPING.
8. FIBERGLASS WINDOW.
9. ALUMINUM STOREFRONT AND WINDOW SYSTEM.
10. SCREENED OPENINGS SET IN FRAME/STOPS.
11. EXPOSED ENTRY STEEL COLUMN AND BEAM.
12. ALUMINUM SERVING WINDOW.
13. METAL SERVICE DOOR.
14. BRAKE-METAL FLASHING/CAP AT IRREGULAR DOOR HEAD/CONCRETE MASONRY UNIT COURSING.
15. SNACK SHACK ROOF ELEMENT.
16. LOUVER/GRILLE. LOCATIONS TO BE DETERMINED.
17. SKYLIGHTS BEYOND.
18. BUILDING SIGN (FLOATING ELEMENT AS OPTION). NOTE: SIGNAGE WILL NOT HAVE INTEGRAL LIGHTING.
19. ACCENT SIGN.
20. STREET NUMBER.
21. APPROXIMATE SIDEWALK ELEVATION.
22. (FUTURE) SOLAR PANELS.
23. (FUTURE) BENCHES.
24. CHAIN LINK FENCE.

**PROGRESS PLANS
NOT FOR CONSTRUCTION**

DRAWING ISSUE DATES
3-14-2022



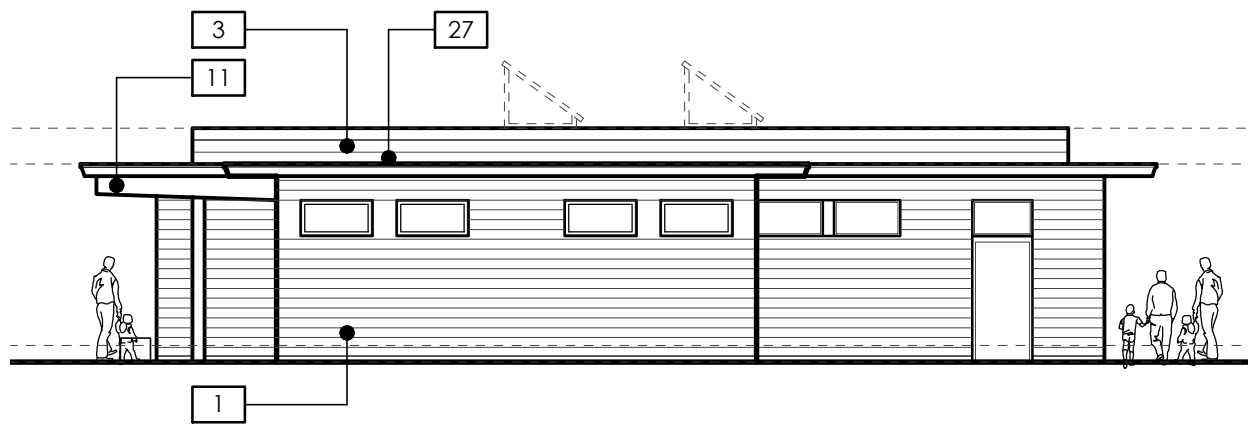

1 WEST ELEVATION

SCALE: 3/32"=1'-0" @ 11"x17"

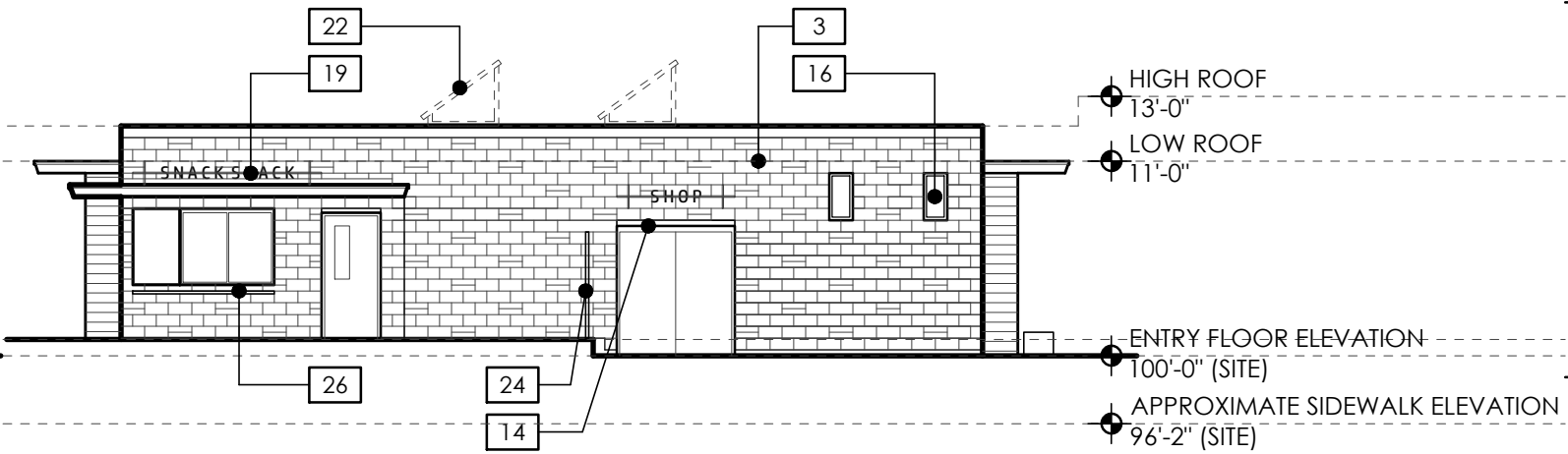

2 EAST ELEVATION

SCALE: 3/32"=1'-0" @ 11"x17"

KEYED NOTES

1. ENGINEERED WOOD LAP SIDING. COLOR: EARTH TONE RANGE.
2. ENGINEERED WOOD TRIM/PANEL. COLOR: EARTH TONE RANGE.
3. 8" X 8" X 16" NOMINAL CONCRETE MASONRY UNIT "BRICKS" (WITH OPTIONAL ACCENTS AS SHOWN). COLOR: RED TONE RANGE.
4. EXPOSED CONCRETE CURB AT BASE OF WALL.
5. ENGINEERED WOOD TRIM FASCIA. COLOR: EARTH TONE RANGE.
6. BRASS-METAL SIDING CORNER/DIVIDER STRIP. COLOR: MATCH SIDING AS PRACTICAL.
7. METAL COPING.
8. FIBERGLASS WINDOW. COLOR: BLACK.
9. ALUMINUM STOREFRONT DOOR AND WINDOW SYSTEM. COLOR: BLACK.
10. SCREENED OPENINGS SET IN FRAME/STOPS. COLOR: BLACK.
11. EXPOSED ENTRY STEEL COLUMN AND BEAM. COLOR: MATCH MASONRY AS PRACTICAL.
12. ALUMINUM SERVING WINDOW. COLOR: BLACK.
13. METAL SERVICE DOOR. COLOR: MATCH MASONRY AS PRACTICAL.
14. BRASS-METAL FLASHING/CAP AT IRREGULAR DOOR HEAD/CONCRETE MASONRY UNIT COURSING. COLOR: BLACK.
15. SNACK SHACK ROOF ELEMENT.
16. LOUVER/GRILLE. LOCATIONS TO BE DETERMINED. COLOR: BLACK.
17. SKYLIGHTS BEYOND.
18. BUILDING SIGN (FLOATING ELEMENT AS OPTION). NOTE: SIGNAGE WILL NOT HAVE INTEGRAL LIGHTING.
19. ACCENT SIGN.
20. STREET NUMBER.
21. APPROXIMATE SIDEWALK ELEVATION.
22. (FUTURE) SOLAR PANELS.
23. (FUTURE) BENCHES.
24. CHAIN LINK FENCE.
25. LINE OF UPPER DECK SECTION BEYOND (UP APPROXIMATELY 11").
26. SERVING COUNTER.
27. FLASHING. COLOR: MATCH MASONRY AS PRACTICAL.



Barnett Architecture

118 NORTH BREESE TERRACE
SUITE I
MADISON, WISCONSIN 53726
608.233.4538
barnettarchitecture.com

PROPOSED RENOVATION

RIDGEWOOD POOL

5109 BARTON ROAD
MADISON, WI 53711



**PROGRESS PLANS
NOT FOR CONSTRUCTION**

DRAWING ISSUE DATES
3-14-2022

11 Mar 2022 - 1:54p K:\Carrico Engineering\Projects\2019\190015 Ridgewood Pool - DC Engineering\CADD\190015_Base Engineering.dwg by Admin2\Fix

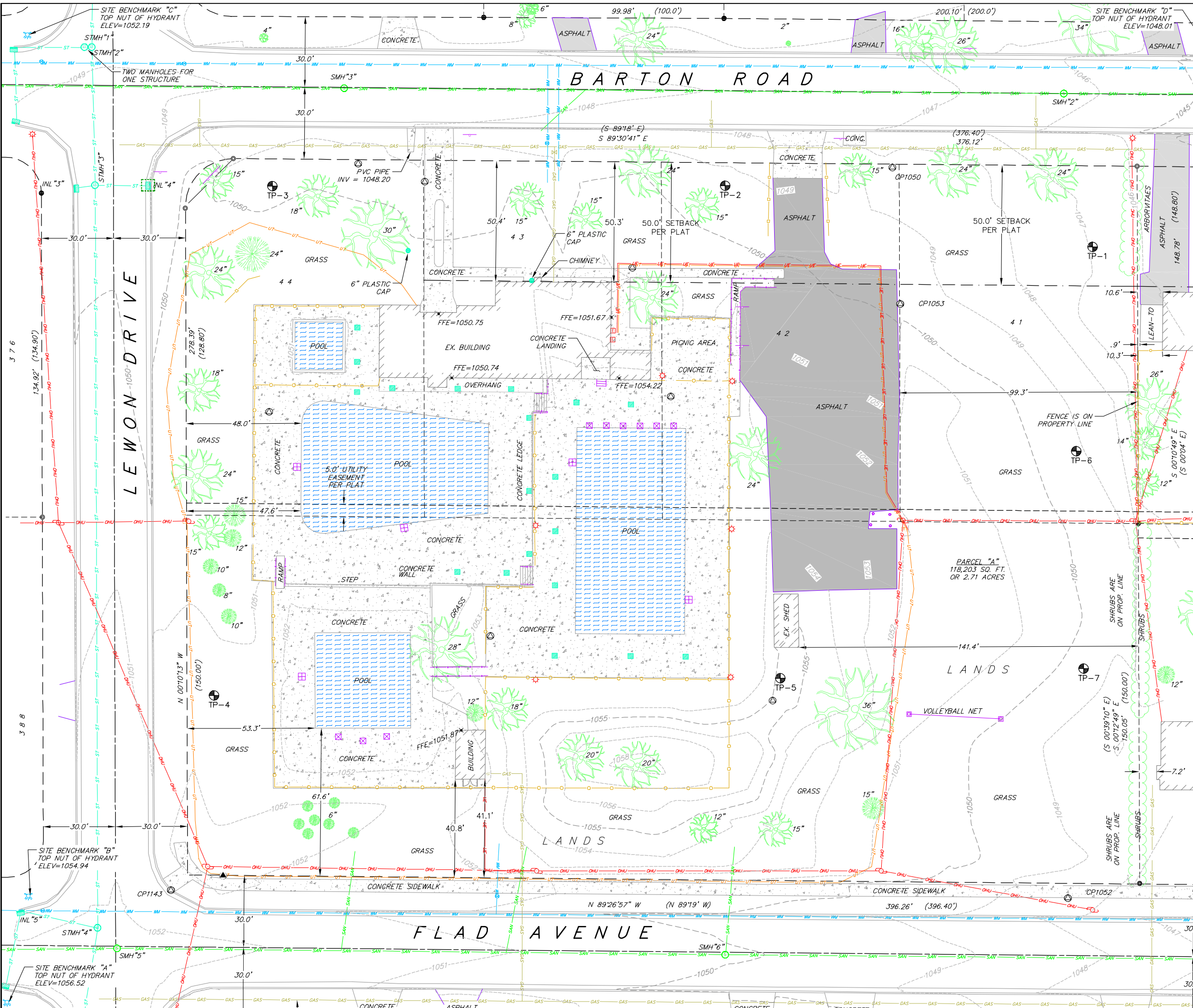

N
W E
S

GRAPHIC SCALE (FT)
0 10 20 40

DC ENGINEERING
Careful listening. Dynamic solutions.
www.dcengineering.net

EXISTING CONDITIONS & TOPOGRAPHIC LINWORK/SYMBOL LEGEND

	FOUND NAIL
	FOUND 1" Ø IRON PIPE
	FOUND 2" Ø IRON PIPE
	FOUND 3/4" Ø IRON ROD
	SET NAIL
	EXISTING BUILDING FINISH FLOOR ELEVATION
	EXISTING BOLLARD
	EXISTING POST
	EXISTING SIGN (TYPE NOTED)
	EXISTING CURB INLET
	EXISTING FIELD INLET RECTANGULAR
	EXISTING STORM MANHOLE
	6" PLASTIC CAP/CLEAN-OUT
	EXISTING SANITARY MANHOLE
	EXISTING FIRE HYDRANT
	EXISTING WATER MAIN VALVE
	EXISTING GAS VALVE
	EXISTING GAS METER
	EXISTING ELECTRIC PEDESTAL
	EXISTING LIGHT POLE
	EXISTING UTILITY POLE
	EXISTING TELEPHONE PEDESTAL
	EXISTING CONIFEROUS TREE
	EXISTING DECIDUOUS TREE
	EXISTING BORING LOCATION
	EXISTING RIGHT-OF-WAY LINE
	EXISTING PROPERTY LINE
	EXISTING PROPERTY CENTERLINE
	EXISTING SETBACK LINE
	EXISTING UTILITY EASEMENT LINE
	EXISTING CURB AND GUTTER
	EXISTING UNDERGROUND COMMUNICATIONS
	EXISTING GENERAL FENCE
	EXISTING HAND RAIL
	EXISTING GAS LINE
	EXISTING UNDERGROUND ELECTRIC LINE
	EXISTING OVERHEAD GENERAL UTILITIES
	EXISTING SANITARY SEWER LINE
	EXISTING STORM SEWER LINE
	EXISTING EDGE OF TREES
	EXISTING WATER MAIN
	EXISTING MAJOR CONTOUR
	EXISTING MINOR CONTOUR
	EXISTING ASPHALT PAVEMENT
	EXISTING CONCRETE PAVEMENT
	EXISTING BUILDING
	EXISTING POOL AREA

NOTES:

- TOPOGRAPHIC AND EXISTING CONDITIONS INFORMATION BASED ON SURVEY COMPLETED BY OTHERS DATED JUNE 25, 2015 AND APRIL 5, 2021.
- THE LOCATION OF ANY AND ALL EXISTING UNDERGROUND UTILITIES AS SHOWN ON THE PLANS HAS BEEN DETERMINED FROM THE SURVEY BY OTHERS AND BY THE BEST AVAILABLE INFORMATION AND IS GIVEN FOR THE CONVENIENCE OF THE CONTRACTOR.
- ALL INFORMATION SHALL BE FIELD VERIFIED BY CONTRACTOR. ALL DIMENSIONS AND LOCATIONS SHALL BE VERIFIED WITH THE ARCHITECTURAL DRAWINGS. IF CONFLICTS EXIST THE USER OF THESE DRAWINGS SHALL CONTACT THE ENGINEER IMMEDIATELY.

Carrico Engineering
www.carricoengineering.com
(608) 832-6352

Existing Conditions Plan
Ridgewood Pool
City of Madison
Dane County, Wisconsin

Revisions		Description	
No.	Date	No.	Date

Scale:	AS SHOWN
Date:	3/14/2022
Drawn By:	ALC
Project No:	190015
Sheet No:	C1.0

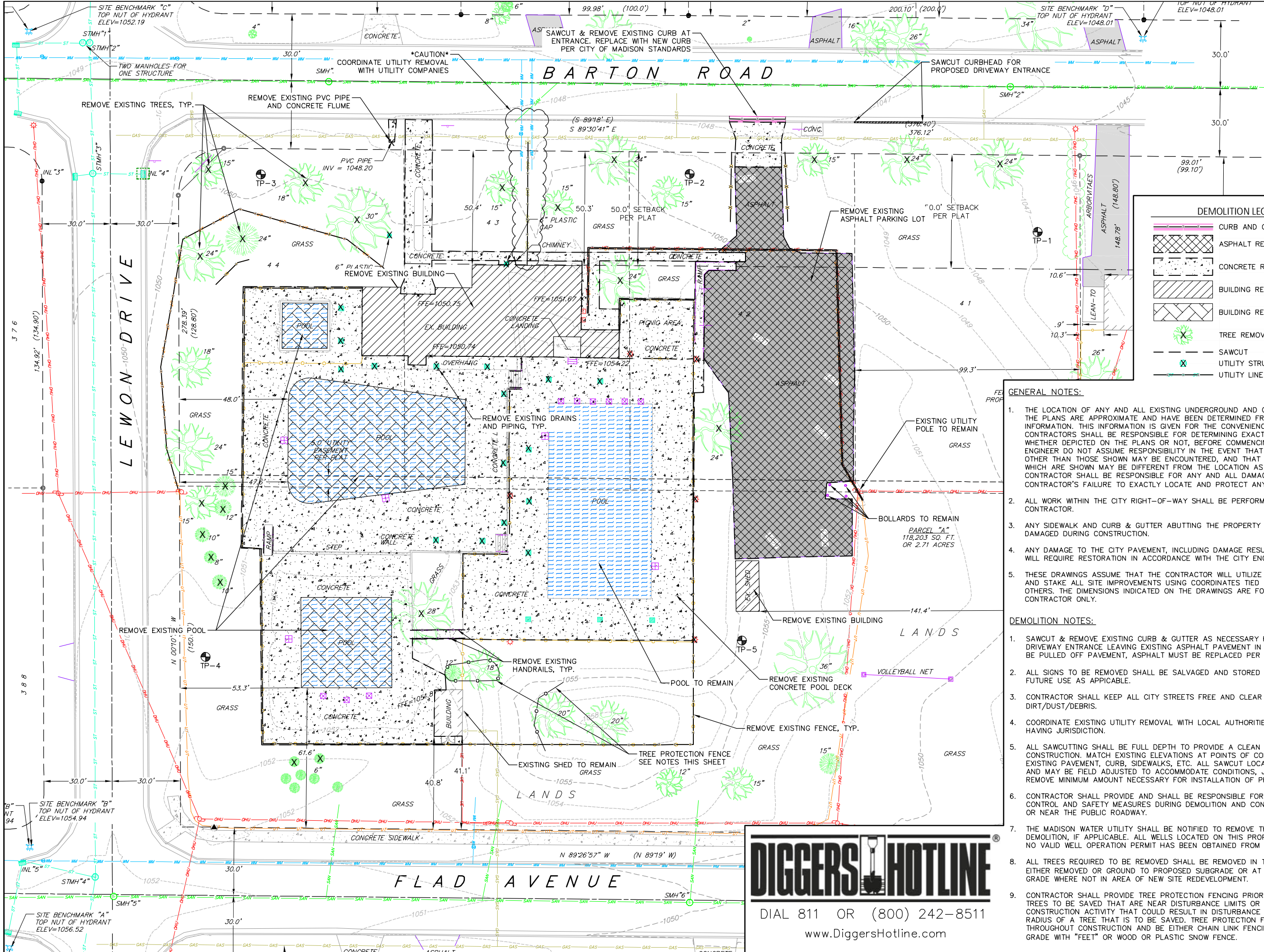

N
W E
S









GRAPHIC SCALE (FT)
0 10 20 40

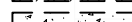
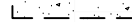

DC ENGINEERING
Careful listening. Dynamic solutions.
www.dceengineering.net

Carrico Engineering
Engineering
carricoengineering.com
(608) 832-6352

DEMOLITION LEGEND

-  CURB AND GUTTER REMOVAL
-  ASPHALT REMOVAL
-  CONCRETE REMOVAL
-  BUILDING REMOVAL
-  BUILDING REMOVAL
-  TREE REMOVAL
-  SAWCUT
-  UTILITY STRUCTURE REMOVAL
-  UTILITY LINE REMOVAL

- GENERAL NOTES:**
- THE LOCATION OF ANY AND ALL EXISTING UNDERGROUND AND OVERHEAD UTILITIES AS SHOWN ON THE PLANS ARE APPROXIMATE AND HAVE BEEN DETERMINED FROM THE BEST AVAILABLE INFORMATION. THIS INFORMATION IS GIVEN FOR THE CONVENIENCE OF THE CONTRACTOR. THE CONTRACTORS SHALL BE RESPONSIBLE FOR DETERMINING EXACT LOCATION OF ANY UTILITIES, WHETHER DEPICTED ON THE PLANS OR NOT, BEFORE COMMENCING WORK. THE OWNER AND THE ENGINEER DO NOT ASSUME RESPONSIBILITY IN THE EVENT THAT DURING CONSTRUCTION, UTILITIES OTHER THAN THOSE SHOWN MAY BE ENCOUNTERED, AND THAT THE ACTUAL LOCATION OF THOSE WHICH ARE SHOWN MAY BE DIFFERENT FROM THE LOCATION AS SHOWN ON THE PLANS. THE CONTRACTOR SHALL BE RESPONSIBLE FOR ANY AND ALL DAMAGES THAT ARISE BY THE CONTRACTOR'S FAILURE TO EXACTLY LOCATE AND PROTECT ANY AND ALL UTILITIES.
 - ALL WORK WITHIN THE CITY RIGHT-OF-WAY SHALL BE PERFORMED BY A CITY LICENSED CONTRACTOR.
 - ANY SIDEWALK AND CURB & GUTTER ABUTTING THE PROPERTY SHALL BE REPLACED IF IT IS DAMAGED DURING CONSTRUCTION.
 - ANY DAMAGE TO THE CITY PAVEMENT, INCLUDING DAMAGE RESULTING FROM CURB REPLACEMENT, WILL REQUIRE RESTORATION IN ACCORDANCE WITH THE CITY ENGINEERING PATCHING CRITERIA.
 - THESE DRAWINGS ASSUME THAT THE CONTRACTOR WILL UTILIZE AN ELECTRONIC DRAWING FILE AND STAKE ALL SITE IMPROVEMENTS USING COORDINATES TIED INTO CONTROL POINTS SET BY OTHERS. THE DIMENSIONS INDICATED ON THE DRAWINGS ARE FOR THE CONVENIENCE OF THE CONTRACTOR ONLY.

- DEMOLITION NOTES:**
- SAWCUT & REMOVE EXISTING CURB & GUTTER AS NECESSARY FOR REMOVAL OF EXISTING DRIVEWAY ENTRANCE LEAVING EXISTING ASPHALT PAVEMENT IN TACT. IF EXISTING CURB CANNOT BE PULLED OFF PAVEMENT, ASPHALT MUST BE REPLACED PER CITY OF MADISON REQUIREMENTS.
 - ALL SIGNS TO BE REMOVED SHALL BE SALVAGED AND STORED IN THE OWNER'S FACILITY FOR FUTURE USE AS APPICABLE.
 - CONTRACTOR SHALL KEEP ALL CITY STREETS FREE AND CLEAR OF CONSTRUCTION RELATED DIRT/DUST/DEBRIS.
 - COORDINATE EXISTING UTILITY REMOVAL WITH LOCAL AUTHORITIES AND UTILITY COMPANIES HAVING JURISDICTION.
 - ALL SAWCUTTING SHALL BE FULL DEPTH TO PROVIDE A CLEAN EDGE TO MATCH NEW CONSTRUCTION. MATCH EXISTING ELEVATIONS AT POINTS OF CONNECTION FOR NEW AND EXISTING PAVEMENT, CURB, SIDEWALKS, ETC. ALL SAWCUT LOCATIONS SHOWN ARE APPROXIMATE AND MAY BE FIELD ADJUSTED TO ACCOMMODATE CONDITIONS, JOINTS, MATERIAL TYPE, ETC. REMOVE MINIMUM AMOUNT NECESSARY FOR INSTALLATION OF PROPOSED IMPROVEMENTS.
 - CONTRACTOR SHALL PROVIDE AND SHALL BE RESPONSIBLE FOR ANY NECESSARY TRAFFIC CONTROL AND SAFETY MEASURES DURING DEMOLITION AND CONSTRUCTION OPERATIONS WITHIN OR NEAR THE PUBLIC ROADWAY.
 - THE MADISON WATER UTILITY SHALL BE NOTIFIED TO REMOVE THE WATER METER PRIOR TO DEMOLITION, IF APPLICABLE. ALL WELLS LOCATED ON THIS PROPERTY SHALL BE ABANDONED IF NO VALID WELL OPERATION PERMIT HAS BEEN OBTAINED FROM THE MADISON WATER UTILITY.
 - ALL TREES REQUIRED TO BE REMOVED SHALL BE REMOVED IN THEIR ENTIRETY AND STUMPS EITHER REMOVED OR GROUND TO PROPOSED SUBGRADE OR AT LEAST 4" BELOW FINISHED GRADE WHERE NOT IN AREA OF NEW SITE REDEVELOPMENT.
 - CONTRACTOR SHALL PROVIDE TREE PROTECTION FENCING PRIOR TO CONSTRUCTION FOR ANY TREES TO BE SAVED THAT ARE NEAR DISTURBANCE LIMITS OR WHENEVER THERE WILL BE CONSTRUCTION ACTIVITY THAT COULD RESULT IN DISTURBANCE WITHIN THE CRITICAL ROOT RADIUS OF A TREE THAT IS TO BE SAVED. TREE PROTECTION FENCING SHALL BE MAINTAINED THROUGHOUT CONSTRUCTION AND BE EITHER CHAIN LINK FENCING THAT ARE INSTALLED ON GRADE WITH "FEET" OR WOOD OR PLASTIC SNOW FENCE.

DIGGERS HOTLINE
DIAL 811 OR (800) 242-8511
www.DiggersHotline.com

Demolition Plan
Ridgewood Pool
City of Madison
Dane County, Wisconsin

Revisions		Revisions	
No.	Date	Description	Date

Scale: AS SHOWN
Date: 3/14/2022
Drawn By: ALC
Project No: 190015
Sheet No: C2.0

14 Mar 2022 - 9:45a K:\Carrico Engineering\Projects\2019\190015 Ridgewood Pool - DC Engineering\CADD\190015_Base Engineering.dwg by Admin2\Fix

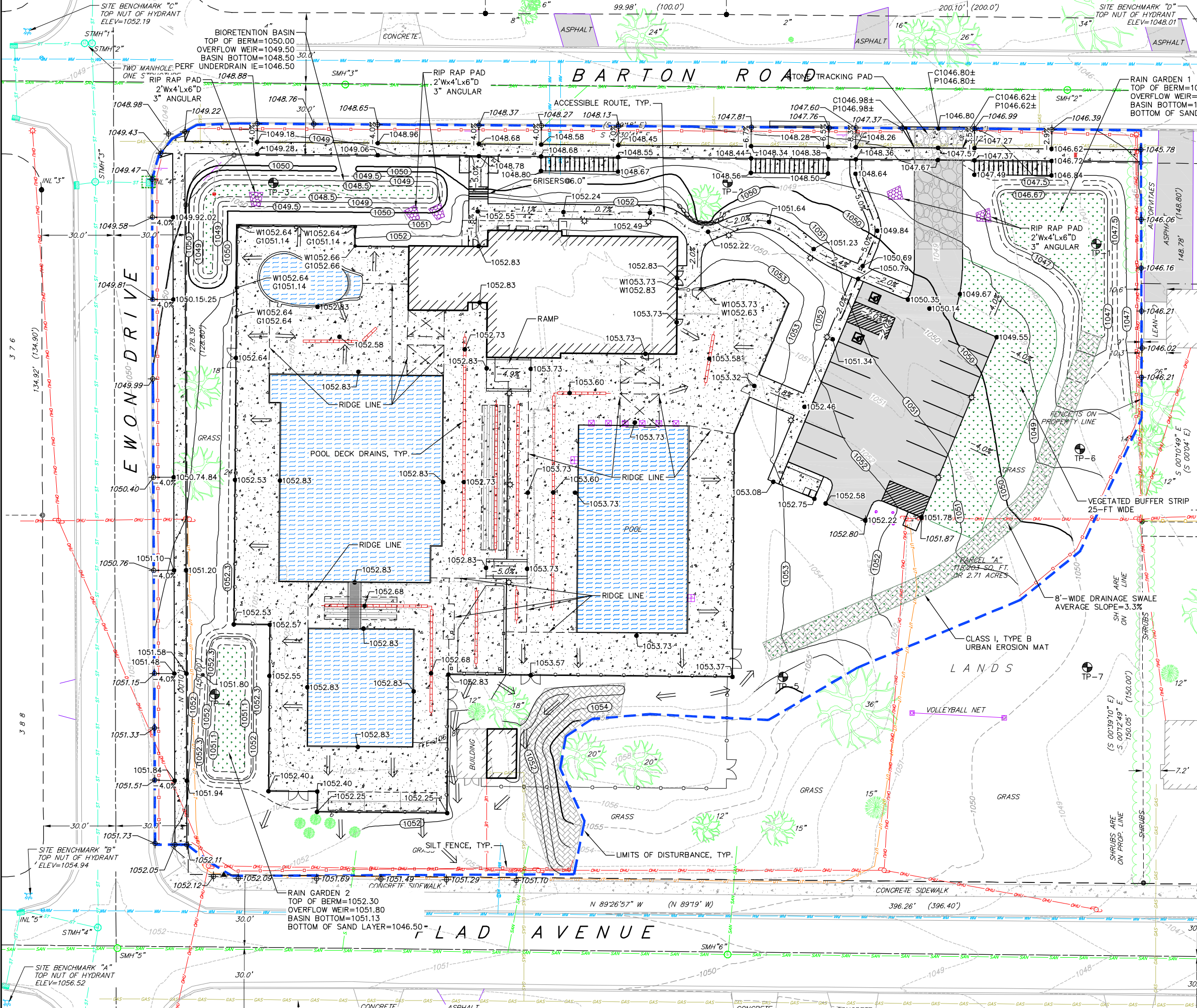

GRAPHIC SCALE (FT)
0 10 20 40

DC ENGINEERING
Careful listening. Dynamic solutions
www.dcengineering.net

GRADING & EROSION CONTROL LEGEND

- 820 EXISTING MAJOR CONTOURS
- 818 EXISTING MINOR CONTOURS
- 820 PROPOSED MAJOR CONTOURS
- 818 PROPOSED MINOR CONTOURS
- SILT FENCE
- DISTURBED LIMITS
- ACCESSIBLE ROUTE
- DRAINAGE DIRECTION
- PROPOSED SLOPE ARROWS
- EXISTING SPOT ELEVATIONS
- PROPOSED SPOT ELEVATIONS
- INLET PROTECTION
- EROSION MAT CLASS I, TYPE B URBAN
- TRACKING PAD
- RIP RAP

ABBREVIATIONS

- C - BACK OF CURB ELEV.
- P - EDGE OF PAVEMENT ELEV.
- FF - FINISHED FLOOR ELEV.
- W - EDGE OF SIDEWALK ELEV.
- T/W - TOP OF WALL ELEV.
- B/W - BOTTOM OF WALL ELEV.
- G - GROUND ELEV.

ACCESSIBLE ROUTE NOTES:

- ACCESSIBLE ROUTES SHALL BE 5% MAX LONGITUDINAL SLOPE AND 2% MAX CROSS SLOPE.
- ACCESSIBLE LOADING AREAS OR LANDINGS SHALL BE 2% MAX IN ANY DIRECTION.
- RAMPS SHALL BE 8.33% MAX.

Carrico Engineering
608) 832-6352 | carricoengineering.com

Grading and Erosion Control Plan
Ridgewood Pool
City of Madison
Dane County, Wisconsin

Revisions	No.	Date	Description

Scale: AS SHOWN
Date: 3/14/2022
Drawn By: ALC
Project No: 190015
Sheet No: C3.0

11 Mar 2022 - 2:24p K:\Carrico Engineering\Projects\2019\190015 Ridgewood Pool - DC Engineering\CADD\190015_Base Engineering.dwg by Admin2fX

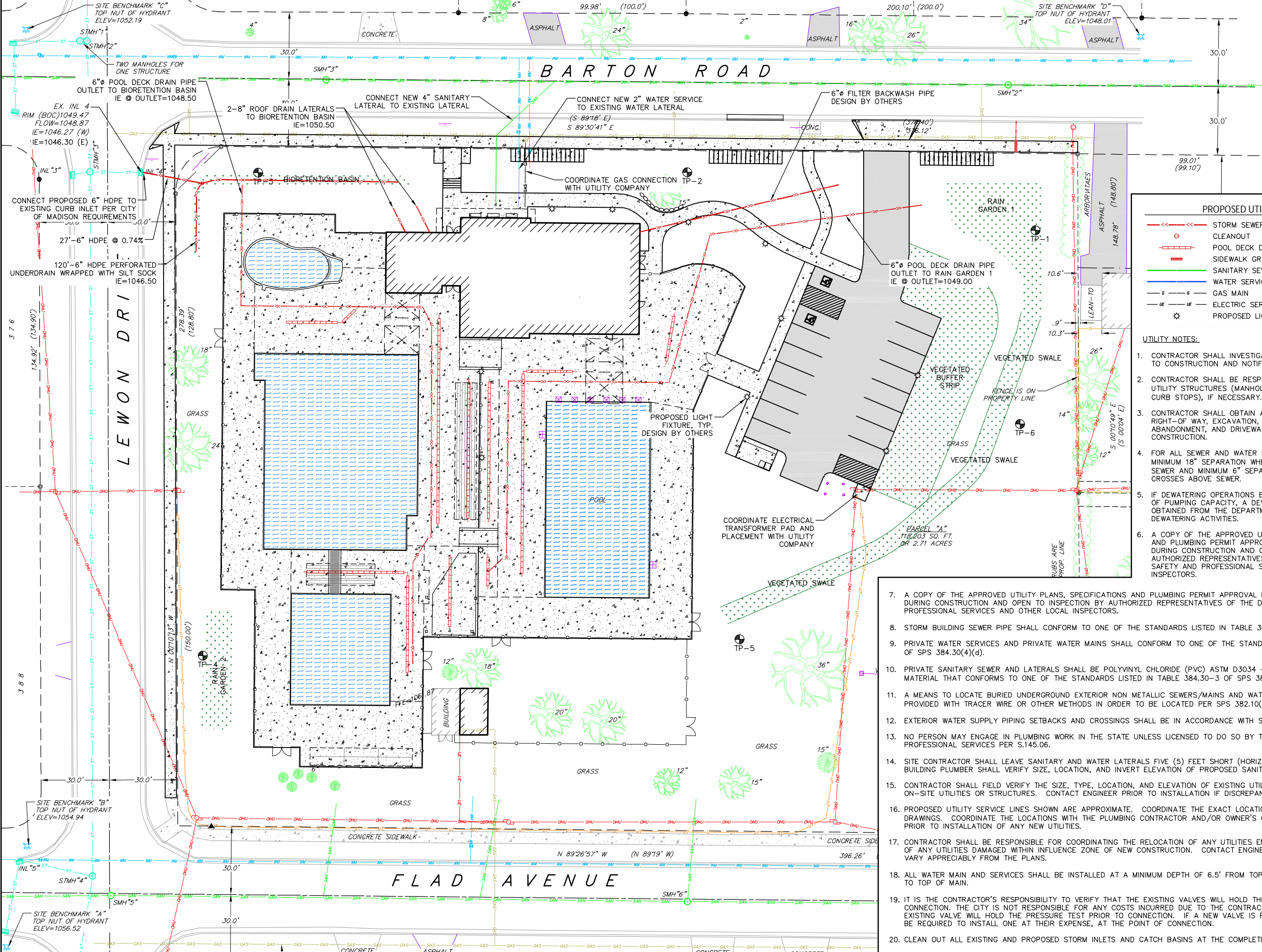

SITE BENCHMARK "C" TOP NUT OF HYDRANT ELEV=1052.19

SITE BENCHMARK "D" TOP NUT OF HYDRANT ELEV=1048.01

SITE BENCHMARK "B" TOP NUT OF HYDRANT ELEV=1054.94

SITE BENCHMARK "A" TOP NUT OF HYDRANT ELEV=1056.52

GRAPHIC SCALE (FT)

DC ENGINEERING
Careful listening. Dynamic solutions.
www.dcengineering.net

Carrico Engineering
608) 832-6352 | carricoengineering.com

PROPOSED UTILITY LEGEND

- STORM SEWER PIPE
- CLEANOUT
- POOL DECK DRAINS
- SIDEWALK GRATE DRAIN
- SANITARY SEWER LATERAL PIPE
- WATER SERVICE LATERAL PIPE
- GAS MAIN
- ELECTRIC SERVICE
- PROPOSED LIGHT POLE

UTILITY NOTES:

- CONTRACTOR SHALL INVESTIGATE ALL UTILITY CROSSINGS PRIOR TO CONSTRUCTION AND NOTIFY ENGINEER OF ANY CONFLICTS.
- CONTRACTOR SHALL BE RESPONSIBLE FOR ADJUSTING ALL UTILITY STRUCTURES (MANHOLE RIMS, WATER VALVES, AND CURB STOPS), IF NECESSARY.
- CONTRACTOR SHALL OBTAIN ANY NECESSARY WORK IN RIGHT-OF-WAY, EXCAVATION, UTILITY CONNECTION, PLUGGING, ABANDONMENT, AND DRIVEWAY CONNECTION PERMITS PRIOR TO CONSTRUCTION.
- FOR ALL SEWER AND WATER MAIN CROSSINGS: PROVIDE MINIMUM 18" SEPARATION WHEN WATER MAIN CROSSES BELOW SEWER AND MINIMUM 6" SEPARATION WHEN WATER MAIN CROSSES ABOVE SEWER.
- IF DEWATERING OPERATIONS EXCEED 70 GALLONS PER MINUTE OF PUMPING CAPACITY, A DEWATERING WELL PERMIT SHALL BE OBTAINED FROM THE DEPARTMENT PRIOR TO STARTING ANY DEWATERING ACTIVITIES.
- A COPY OF THE APPROVED UTILITY PLANS, SPECIFICATIONS AND PLUMBING PERMIT APPROVAL LETTER SHALL BE ON-SITE DURING CONSTRUCTION AND OPEN TO INSPECTION BY AUTHORIZED REPRESENTATIVES OF THE DEPARTMENT OF SAFETY AND PROFESSIONAL SERVICES AND OTHER LOCAL INSPECTORS.

- A COPY OF THE APPROVED UTILITY PLANS, SPECIFICATIONS AND PLUMBING PERMIT APPROVAL LETTER SHALL BE ON-SITE DURING CONSTRUCTION AND OPEN TO INSPECTION BY AUTHORIZED REPRESENTATIVES OF THE DEPARTMENT OF SAFETY AND PROFESSIONAL SERVICES AND OTHER LOCAL INSPECTORS.
- STORM BUILDING SEWER PIPE SHALL CONFORM TO ONE OF THE STANDARDS LISTED IN TABLE 384.30-6 OF SPS 384.30(3)(c).
- PRIVATE WATER SERVICES AND PRIVATE WATER MAINS SHALL CONFORM TO ONE OF THE STANDARDS LISTED IN TABLE 384.30-7 OF SPS 384.30(4)(d).
- PRIVATE SANITARY SEWER AND LATERALS SHALL BE POLYVINYL CHLORIDE (PVC) ASTM D3034 - SDR 35 OR APPROVED EQUAL MATERIAL THAT CONFORMS TO ONE OF THE STANDARDS LISTED IN TABLE 384.30-3 OF SPS 384.30(2)(c).
- A MEANS TO LOCATE BURIED UNDERGROUND EXTERIOR NON METALLIC SEWERS/MAINS AND WATER SERVICES/MAINS MUST BE PROVIDED WITH TRACER WIRE OR OTHER METHODS IN ORDER TO BE LOCATED PER SPS 382.10(11)(h) AND SPS 382.40(8)(k).
- EXTERIOR WATER SUPPLY PIPING SETBACKS AND CROSSINGS SHALL BE IN ACCORDANCE WITH SPS 382.40(8)(b).
- NO PERSON MAY ENGAGE IN PLUMBING WORK IN THE STATE UNLESS LICENSED TO DO SO BY THE DEPARTMENT OF SAFETY AND PROFESSIONAL SERVICES PER S.145.06.
- SITE CONTRACTOR SHALL LEAVE SANITARY AND WATER LATERALS FIVE (5) FEET SHORT (HORIZONTALLY) FROM THE BUILDING. BUILDING PLUMBER SHALL VERIFY SIZE, LOCATION, AND INVERT ELEVATION OF PROPOSED SANITARY AND WATER LATERALS.
- CONTRACTOR SHALL FIELD VERIFY THE SIZE, TYPE, LOCATION, AND ELEVATION OF EXISTING UTILITIES PRIOR TO INSTALLING ANY ON-SITE UTILITIES OR STRUCTURES. CONTACT ENGINEER PRIOR TO INSTALLATION IF DISCREPANCY EXISTS WITHIN THESE PLANS.
- PROPOSED UTILITY SERVICE LINES SHOWN ARE APPROXIMATE. COORDINATE THE EXACT LOCATIONS WITH THE PLUMBING DRAWINGS. COORDINATE THE LOCATIONS WITH THE PLUMBING CONTRACTOR AND/OR OWNER'S CONSTRUCTION REPRESENTATIVE PRIOR TO INSTALLATION OF ANY NEW UTILITIES.
- CONTRACTOR SHALL BE RESPONSIBLE FOR COORDINATING THE RELOCATION OF ANY UTILITIES ENCOUNTERED AND REPLACEMENT OF ANY UTILITIES DAMAGED WITHIN INFLUENCE ZONE OF NEW CONSTRUCTION. CONTACT ENGINEER IF THE EXISTING UTILITIES VARY APPRECIABLY FROM THE PLANS.
- ALL WATER MAIN AND SERVICES SHALL BE INSTALLED AT A MINIMUM DEPTH OF 6.5' FROM TOP OF FINISHED GROUND ELEVATION TO TOP OF MAIN.
- IT IS THE CONTRACTOR'S RESPONSIBILITY TO VERIFY THAT THE EXISTING VALVES WILL HOLD THE PRESSURE TEST PRIOR TO CONNECTION. THE CITY IS NOT RESPONSIBLE FOR ANY COSTS INCURRED DUE TO THE CONTRACTOR NOT VERIFYING THAT THE EXISTING VALVE WILL HOLD THE PRESSURE TEST PRIOR TO CONNECTION. IF A NEW VALVE IS REQUIRED, THE APPLICANT WILL BE REQUIRED TO INSTALL ONE AT THEIR EXPENSE, AT THE POINT OF CONNECTION.
- CLEAN OUT ALL EXISTING AND PROPOSED STORM INLETS AND CATCH BASINS AT THE COMPLETION OF CONSTRUCTION.

Utility Plan
Ridgewood Pool
City of Madison
Dane County, Wisconsin

Revisions		Revisions	
No.	Description	No.	Description

Scale: AS SHOWN

Date: 3/14/2022

Drawn By: ALC

Project No: 190015

Sheet No: C4.0

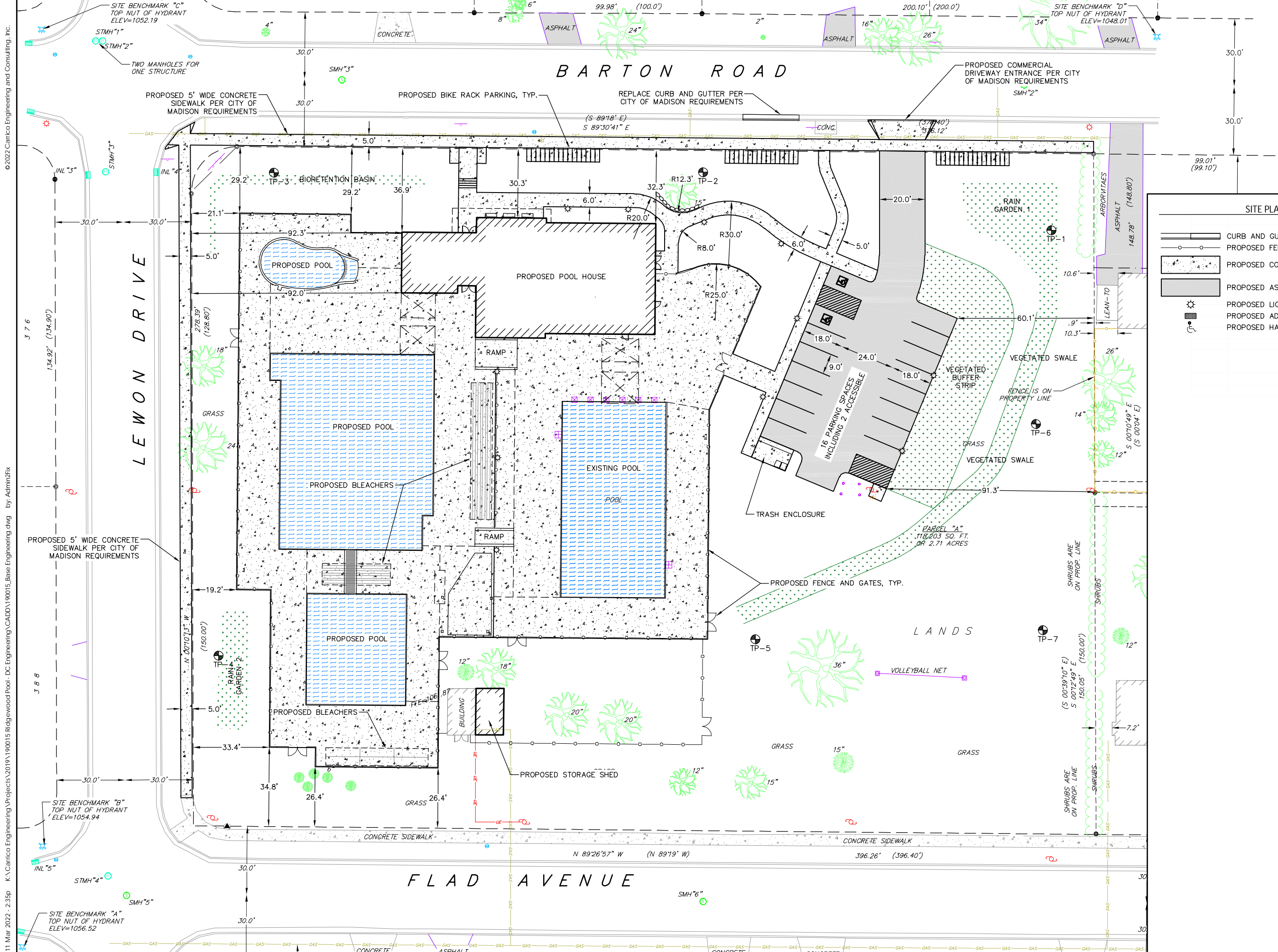

DC ENGINEERING
Careful listening. Dynamic solutions.
www.dcengineering.net

Carrico Engineering
Engineering
(608) 832-6352 | carricoengineering.com

SITE PLAN LEGEND

	CURB AND GUTTER
	PROPOSED FENCE
	PROPOSED CONCRETE
	PROPOSED ASPHALT PAVEMENT
	PROPOSED LIGHT POLE
	PROPOSED ADA DETECTABLE WARNING FIELD
	PROPOSED HANDICAP PARKING

Site Plan
Ridgewood Pool
City of Madison
Dane County, Wisconsin

Revisions		Revisions	
No.	Date	Description	Date

Scale: AS SHOWN

Date: 3/14/2022

Drawn By: ALC

Project No: 190015

Sheet No: C5.0

11 Mar 2022 - 2:35p K:\Carrico Engineering\Projects\2019\190015 Ridgewood Pool - DC Engineering\CADD\190015_Base Engineering.dwg by Admin2\Fix

EROSION CONTROL MEASURES

1. EROSION CONTROL SHALL BE IN ACCORDANCE WITH THE CITY OF MADISON EROSION CONTROL ORDINANCE AND CHAPTER NR 216 OF THE WISCONSIN ADMINISTRATIVE CODE.
2. CONSTRUCT AND MAINTAIN ALL EROSION AND SEDIMENT CONTROL MEASURES IN ACCORDANCE WITH WISCONSIN DNR TECHNICAL STANDARDS.
3. INSTALL SEDIMENT CONTROL PRACTICES PRIOR TO INITIATING OTHER LAND DISTURBING CONSTRUCTION ACTIVITIES.
4. THE CONTRACTOR IS REQUIRED TO MAKE EROSION CONTROL INSPECTIONS AT THE END OF EACH WEEK AND WHEN 0.5 INCHES OF RAIN FALLS WITHIN 24 HOURS. INSPECTION REPORTS SHALL BE PREPARED AND FILED AS REQUIRED BY THE DNR AND/OR CITY. ALL MAINTENANCE WILL FOLLOW AN INSPECTION WITHIN 24 HOURS.
3. EROSION CONTROL IS THE RESPONSIBILITY OF THE CONTRACTOR UNTIL ACCEPTANCE OF THIS PROJECT. EROSION CONTROL MEASURES AS SHOWN SHALL BE THE MINIMUM PRECAUTIONS THAT WILL BE ALLOWED. ADDITIONAL EROSION CONTROL MEASURES, AS REQUESTED IN WRITING BY THE STATE OR LOCAL INSPECTORS, OR THE DEVELOPER'S ENGINEER, SHALL BE INSTALLED WITHIN 24 HOURS.
4. MAINTAIN AND UTILIZE EXISTING ASPHALT DRIVEWAY FOR CONSTRUCTION ENTRANCE. ONCE REMOVED, A 3" CLEAR STONE TRACKING PAD SHALL BE INSTALLED AT THE END OF CONSTRUCTION LIMITS TO PREVENT SEDIMENT FROM BEING TRACKED ONTO THE ADJACENT PAVED PUBLIC ROADWAY. SEDIMENT TRACKING PAD SHALL CONFORM TO WISDNR TECHNICAL STANDARD 1057. SEDIMENT REACHING THE PUBLIC ROAD SHALL BE REMOVED BY STREET CLEANING (NOT HYDRAULIC FLUSHING) BEFORE THE END OF EACH WORK DAY.
5. **STABILIZED DISTURBED GROUND:** ANY SOIL OR DIRT PILES WHICH WILL REMAIN IN EXISTENCE FOR MORE THAN 7-CONSECUTIVE DAYS, WHETHER TO BE WORKED DURING THAT PERIOD OR NOT, SHALL NOT BE LOCATED WITHIN 25- FEET OF ANY ROADWAY, PARKING LOT, PAVED AREA, OR DRAINAGE STRUCTURE OR CHANNEL (UNLESS INTENDED TO BE USED AS PART OF THE EROSION CONTROL MEASURES). TEMPORARY STABILIZATION AND CONTROL MEASURES (SEEDING, MULCHING, TARPING, EROSION MATTING, BARRIER FENCING, ETC.) ARE REQUIRED FOR THE PROTECTION OF DISTURBED AREAS AND SOIL PILES, WHICH WILL REMAIN UN-WORKED FOR A PERIOD OF MORE THAN 14-CONSECUTIVE CALENDAR DAYS. THESE MEASURES SHALL REMAIN IN PLACE UNTIL SITE HAS STABILIZED.
6. **SITE DE-WATERING:** WATER PUMPED FROM THE SITE SHALL BE TREATED BY TEMPORARY SEDIMENTATION BASINS OR OTHER APPROPRIATE CONTROL MEASURES. SEDIMENTATION BASINS SHALL HAVE A DEPTH OF AT LEAST 3 FEET, BE SURROUNDED BY SNOWFENCE OR EQUIVALENT BARRIER AND HAVE SUFFICIENT SURFACE AREA TO PROVIDE A SURFACE SETTLING RATE OF NO MORE THAN 750 GALLONS PER SQUARE FOOT PER DAY AT THE HIGHEST DEWATERING PUMPING RATE. WATER MAY NOT BE DISCHARGED IN A MANNER THAT CAUSES EROSION OF THE SITE, A NEIGHBORING SITE, OR THE BED OR BANKS OF THE RECEIVING WATER. POLYMERS MAY BE USED AS DIRECTED BY DNR TECHNICAL STANDARD 1061 (DE-WATERING).
7. ALL PROJECT AREA STORM INLETS NEED WISCONSIN D.O.T. TYPE D INLET PROTECTION. THE FILTERS SHALL BE MAINTAINED UNTIL THE CITY HAS ACCEPTED THE PROJECT.
8. RESTORATION (SEED, FERTILIZE AND MULCH) SHALL BE PER SPECIFICATIONS ON THIS SHEET UNLESS SPECIAL RESTORATION IS CALLED FOR ON THE LANDSCAPE PLAN OR THE DETENTION BASIN DETAIL SHEET.
9. TERRACES SHALL BE RESTORED WITH 6" TOPSOIL, PERMANENT SEED, FERTILIZER AND MULCH.
10. SEED, FERTILIZER AND MULCH SHALL BE APPLIED WITHIN 7 DAYS AFTER FINAL GRADE HAS BEEN ESTABLISHED. IF DISTURBED AREAS WILL NOT BE RESTORED IMMEDIATELY AFTER ROUGH GRADING, TEMPORARY SEED SHALL BE PLACED.
11. FOR THE FIRST SIX WEEKS AFTER RESTORATION (E.G. SEED & MULCH, EROSION MAT, SOD) OF A DISTURBED AREA, INCLUDE SUMMER WATERING PROVISIONS OF ALL NEWLY SEEDED AND MULCHED AREAS WHENEVER 7 DAYS ELAPSE WITHOUT A RAIN EVENT.
12. EROSION MAT (CLASS I, TYPE B URBAN PER WISCONSIN D.O.T. P.A.L.) SHALL BE INSTALLED ON THE BOTTOM (INVERT) OF SWALES AS SHOWN ON THIS PLAN, 1 ROLL WIDTH.
13. SILT FENCE OR EROSION MAT SHALL BE INSTALLED ALONG THE CONTOURS AT 100 FOOT INTERVALS DOWN THE SLOPE ON THE DISTURBED SLOPES STEEPER THAN 5% AND MORE THAN 100 FEET LONG THAT SHEET FLOW TO THE ROADWAY UNLESS SOIL STABILIZERS ARE USED.
14. INSTALL MINIMUM 6'-7' WIDE EROSION MAT ALONG THE BACK OF CURB AFTER TOPSOIL HAS BEEN PLACED IN THE TERRACE IF THIS AREA WILL NOT BE SEEDED AND MULCHED WITHIN 48 HOURS OF PLACING TOPSOIL.
15. SILT FENCE TO BE USED ACROSS AREAS OF THE LOT THAT SLOPE TOWARDS A PUBLIC STREET. SEE DETAILS.
16. SEDIMENT SHALL BE CLEANED FROM CURB AND GUTTER AFTER EACH RAINFALL AND PRIOR TO PROJECT ACCEPTANCE.
17. ACCUMULATED CONSTRUCTION SEDIMENT SHALL BE REMOVED FROM ALL PERMANENT BASINS TO THE ELEVATION SHOWN ON THE GRADING PLAN FOLLOWING THE STABILIZATION OF DRAINAGE AREAS.
18. ANY PROPOSED CHANGES TO THE EROSION CONTROL PLAN MUST BE SUBMITTED AND APPROVED BY PERMITTING MUNICIPALITY.
19. THE CITY, OWNER AND/OR ENGINEER MAY REQUIRE ADDITIONAL EROSION CONTROL MEASURES AT ANY TIME DURING CONSTRUCTION.

CONSTRUCTION SEQUENCE:

1. INSTALL SILT FENCE PER PLAN
2. INSTALL INLET PROTECTION IN EXISTING STORM INLETS PER PLAN
3. PERFORM DEMOLITION OF SITE
4. ROUGH GRADE FOR BUILDING, POOL AREAS, AND PARKING LOT
5. CONSTRUCT NEW BUILDING AND POOL AREAS
6. CONSTRUCT UNDERGROUND UTILITIES
7. RESTORATION
8. REMOVE TRACKING PAD, SILT FENCE AND DIVERSION BERM MEASURES AFTER DISTURBED AREAS ARE RESTORED

SEEDING RATES:

TEMPORARY:

1. USE ANNUAL OATS AT 3.0 LB./1,000 S.F. FOR SPRING AND SUMMER PLANTINGS.
2. USE WINTER WHEAT OR RYE AT 3.0 LB./1,000 SF FOR FALL PLANTINGS STARTED

AFTER SEPTEMBER 15.

PERMANENT:

1. USE WISCONSIN D.O.T. SEED MIX #40 AT 2 LB./1,000 S.F.

FERTILIZING RATES:

TEMPORARY AND PERMANENT:

USE WISCONSIN D.O.T. TYPE A OR B AT 7 LB./1,000 S.F.

MULCHING RATES:

TEMPORARY AND PERMANENT:

USE 1/2" TO 1-1/2" STRAW OR HAY MULCH, CRIMPED PER SECTION 607.3.2.3, OR OTHER RATE AND METHOD PER SECTION 627, WISCONSIN D.O.T. STANDARD SPECIFICATIONS FOR HIGHWAY AND STRUCTURE CONSTRUCTION

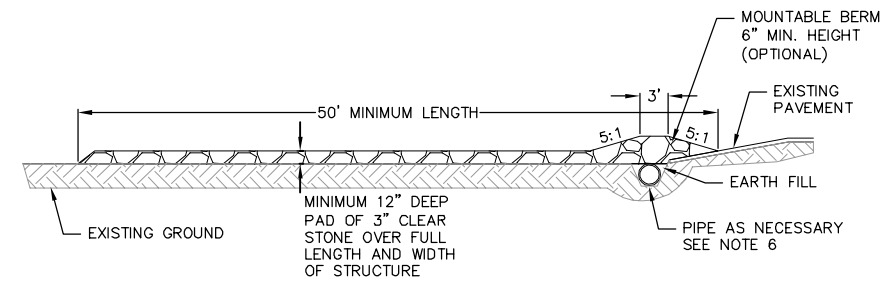

PROFILE VIEW

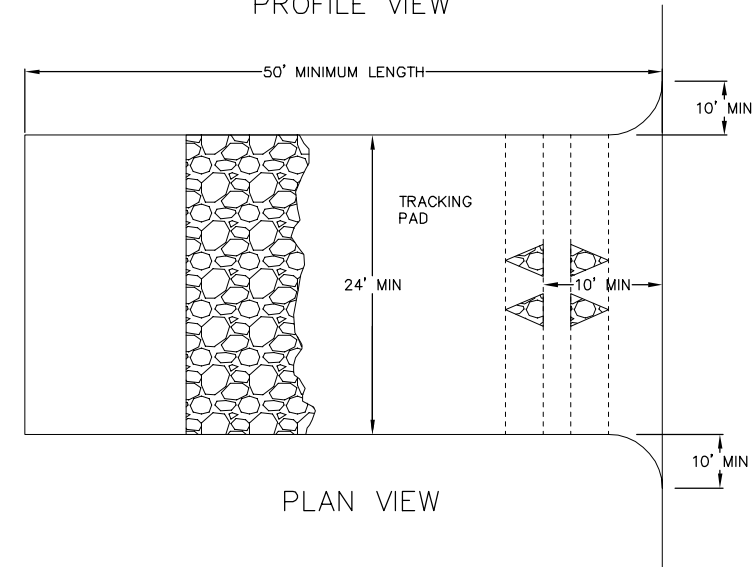

PLAN VIEW

1. FOLLOW WISCONSIN DNR TECHNICAL STANDARD 1057 FOR FURTHER DETAILS AND INSTALLATION.
2. LENGTH - MINIMUM OF 50'
3. WIDTH - 24' MINIMUM, SHOULD BE FLARED AT THE EXISTING ROAD TO PROVIDE A TURNING RADIUS.
4. ON SITES WITH A HIGH GROUND WATER TABLE OR WHERE SATURATED CONDITIONS EXIST, GEOTEXTILE FABRIC SHALL BE PLACED OVER EXISTING GROUND PRIOR TO PLACING STONE. FABRIC SHALL BE WISDOT TYPE-HR GEOTEXTILE FABRIC.
5. STONE - CRUSHED 3" CLEAR STONE SHALL BE PLACED AT LEAST 12" DEEP OVER THE ENTIRE LENGTH AND WIDTH OF ENTRANCE
6. SURFACE WATER - ALL SURFACE WATER FLOWING TO OR DIVERTED TOWARDS CONSTRUCTION ENTRANCES SHALL BE PIPED THROUGH THE ENTRANCE. MAINTAINING POSITIVE DRAINAGE. PIPE INSTALLED THROUGH THE STABILIZED CONSTRUCTION ENTRANCE SHALL BE PROTECTED WITH A MOUNTABLE BERM WITH 5:1 SLOPES AND MINIMUM OF 6" STONE OVER THE PIPE. PIPE SHALL BE SIZED ACCORDING TO THE DRAINAGE REQUIREMENTS. WHEN THE ENTRANCE IS LOCATED AT A HIGH SPOT AND HAS NO DRAINAGE TO CONVEY A PIPE SHALL NOT BE NECESSARY. THE MINIMUM PIPE DIAMETER SHALL BE 6". CONTRACTOR SHALL BE RESPONSIBLE FOR THE MAINTENANCE OF SAID PIPE.
7. LOCATION - A STABILIZED CONSTRUCTION ENTRANCE SHALL BE LOCATED WHERE CONSTRUCTION TRAFFIC ENTERS AND/OR LEAVES THE CONSTRUCTION SITE. VEHICLES LEAVING THE SITE MUST TRAVEL OVER THE ENTIRE LENGTH OF THE TRACKING PAD.

2 TRACKING PAD
C-6.0 NOT TO SCALE

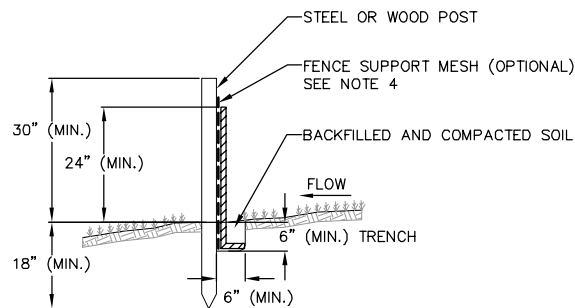

NOTES:

1. INSTALL SILT FENCE TO FOLLOW THE GROUND CONTOURS AS CLOSELY AS POSSIBLE.
2. CURVE THE SILT FENCE UP THE SLOPE TO PREVENT WATER FROM RUNNING AROUND THE ENDS.
3. POST SPACING WITH FENCE SUPPORT MESH = 10 FT. (MAX.)
POST SPACING WITHOUT FENCE SUPPORT MESH = 6 FT. (MAX.)
4. SILT FENCE SUPPORT MESH CONSISTS OF 14-GAUGE STEEL WIRE WITH A MESH SPACING OF 6 IN. X 6 IN. OR PREFABRICATED POLYMERIC MESH OF EQUIVALENT STRENGTH

1 SILT FENCE
C-6.0 NOT TO SCALE

Construction Details

Ridgewood Pool
City of Madison
Dane County, Wisconsin

Revisions		Description	
No.	Date	No.	Date

Scale:	AS SHOWN
Date:	3/14/2022
Drawn By:	ALC
Project No:	190015
Sheet No:	C6.0

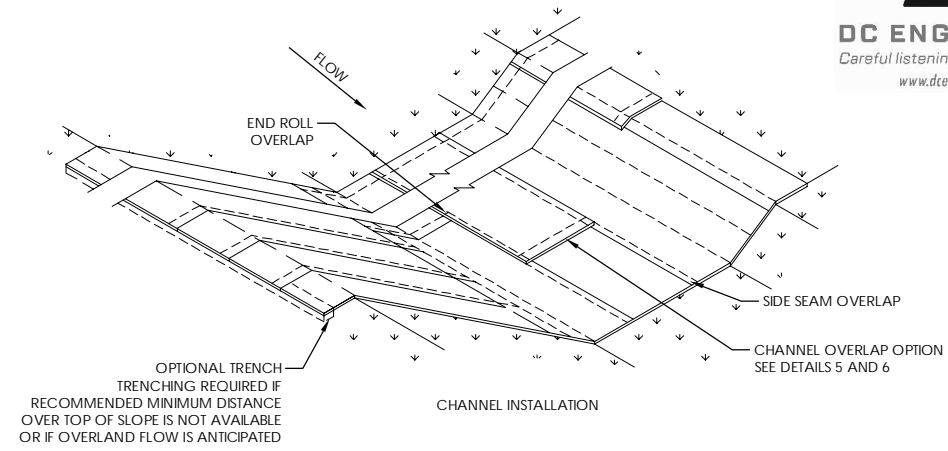
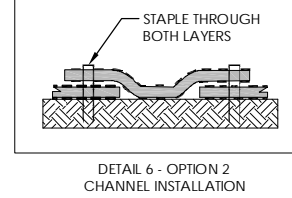
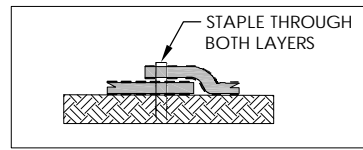
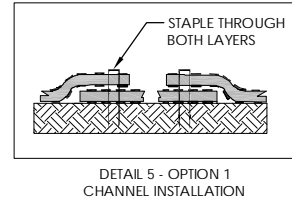
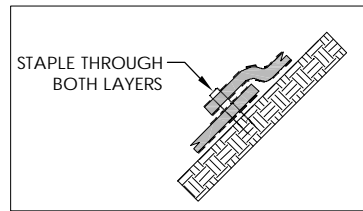
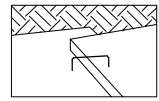
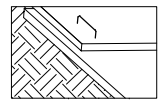
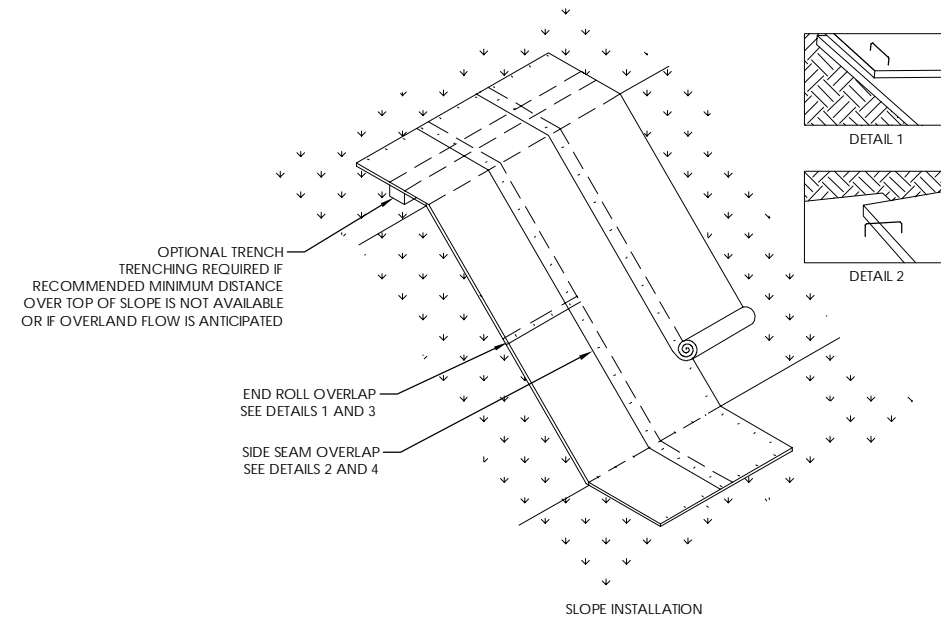

NOTES:

1. STAPLE PATTERNS ARE DEPENDENT UPON SLOPE CONDITIONS AND MANUFACTURER'S RECOMMENDATIONS.
2. STAPLES OF 11 GAUGE OR HEAVIER SHALL BE USED TO HOLD MATS AND NETS IN PLACE.
3. STAPLES SHALL BE U-SHAPED WITH A 1-INCH CROWN.
4. STAPLE LENGTHS ARE DETERMINED BASED ON SOIL CONDITION WITH MINIMUM LENGTH OF 6 INCHES FOR HIGHLY COMPACTED SOILS AND 10 INCHES FOR LOOSE OR SANDY SOILS.
5. FOLLOW MANUFACTURER'S RECOMMENDATIONS FOR BOTH END AND EDGE OVERLAP LENGTH, APPROXIMATELY 2 INCHES.
6. CONSIDER THE USE OF BIODEGRADABLE STAPLES IN LOCATIONS WHERE WIRE STAPLES ARE DETERMINED TO BE A RISK.

1 EROSION MAT DETAIL
C-6.1 NOT TO SCALE

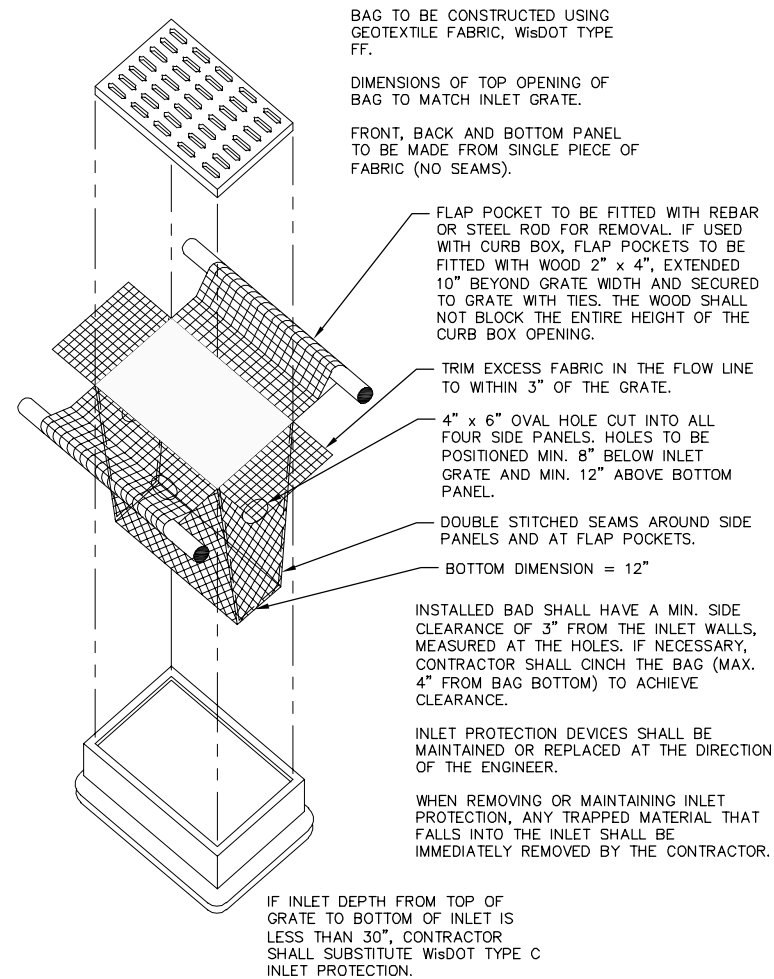

2 INLET PROTECTION TYPE D
C-6.1 NOT TO SCALE

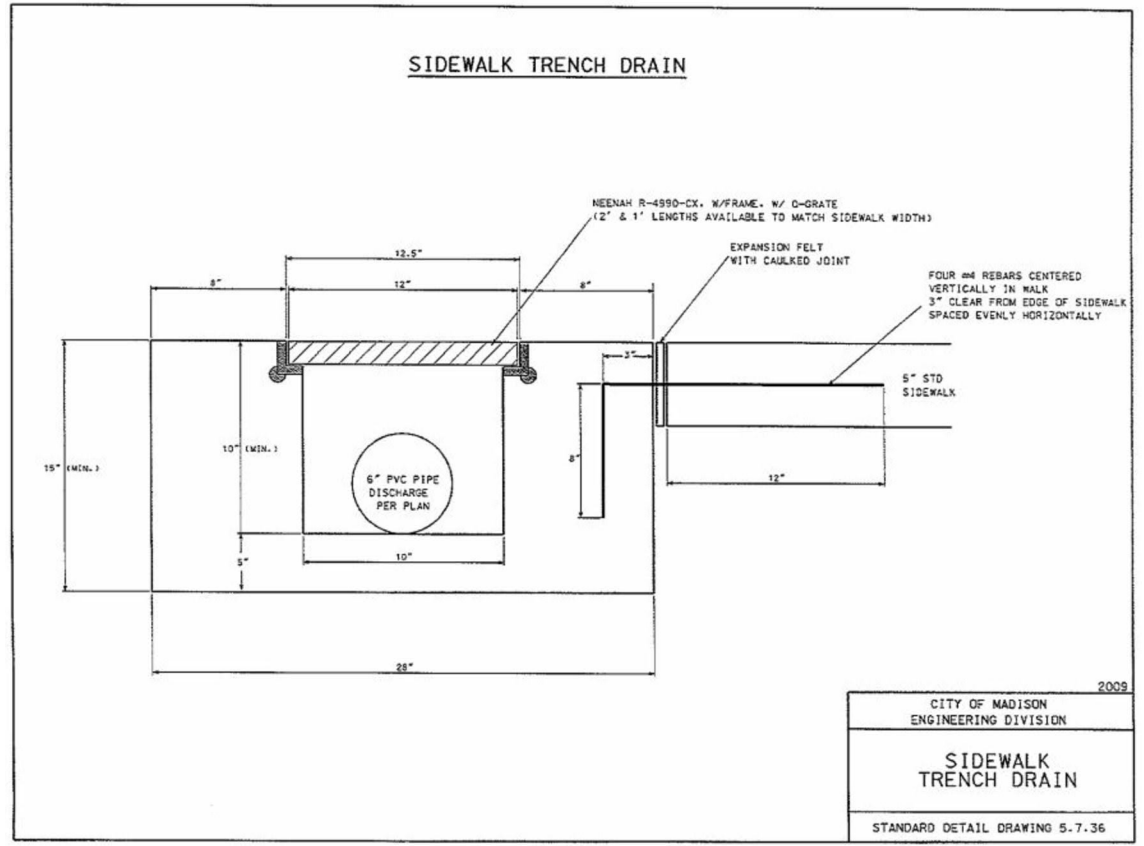

3 SIDEWALK TRENCH DETAIL
C-6.1 NOT TO SCALE

Construction Details
Ridgewood Pool
City of Madison
Dane County, Wisconsin

Revisions		Revisions	
No.	Date	Description	Date

Scale:	AS SHOWN
Date:	3/14/2022
Drawn By:	ALC
Project No:	190015
Sheet No:	C6.1

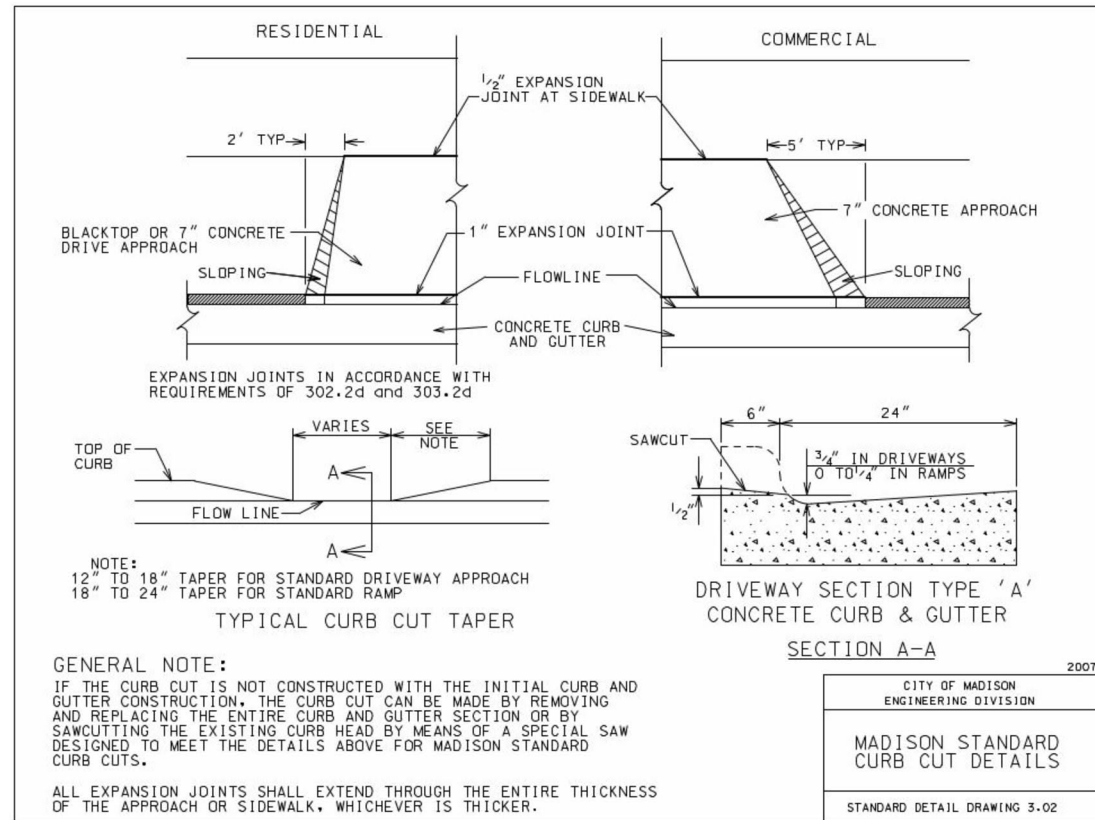

1 CURB CUT DETAIL
C-6.2 NOT TO SCALE

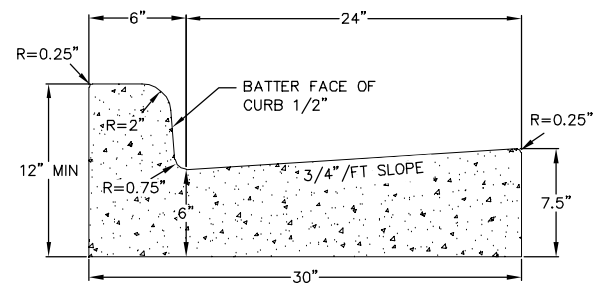

CURB AND GUTTER CROSS SECTION

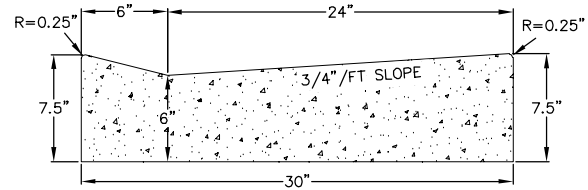

DRIVEWAY GUTTER CROSS SECTION

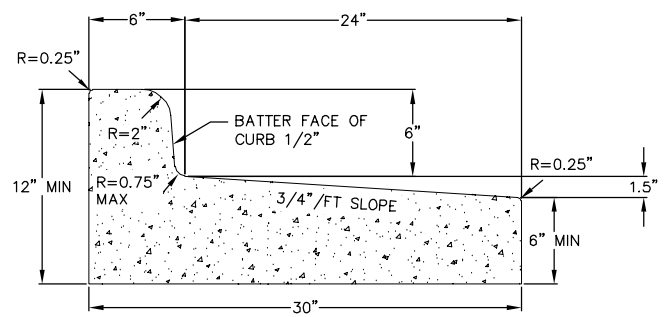

CURB AND GUTTER REJECT SECTION

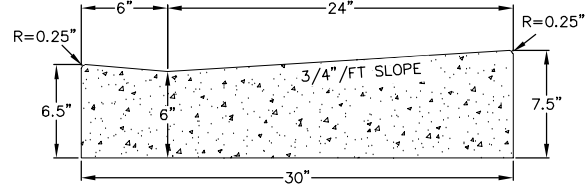

HANDICAP RAMP GUTTER CROSS SECTION

3 30\"/>

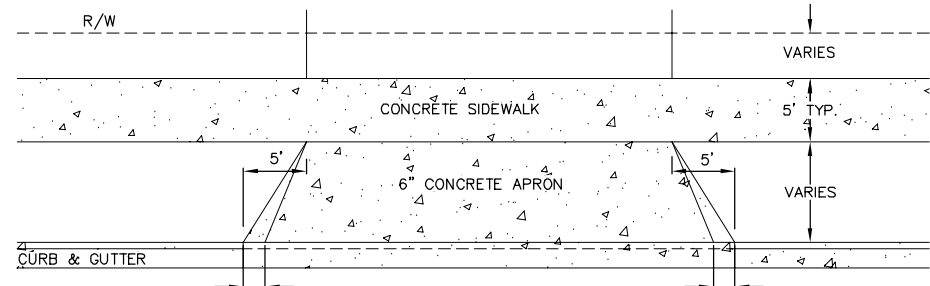

2 DRIVEWAY DETAIL
C-6.2 NOT TO SCALE

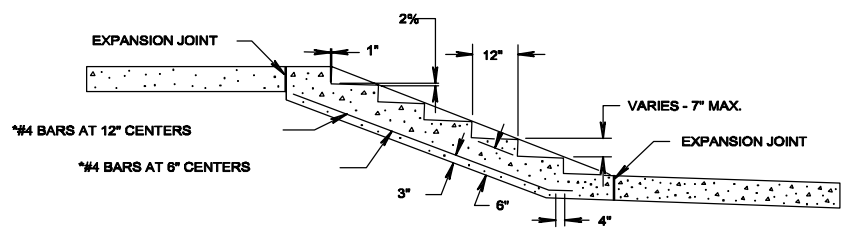

*BAR STEEL REINFORCEMENT SHALL BE EMBEDDED 3 INCHES CLEAR

SECTION A-A

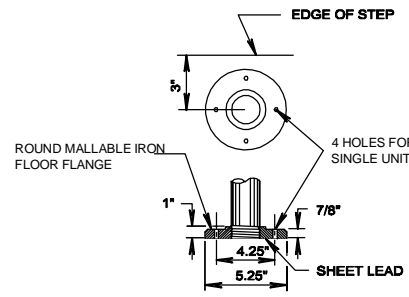

FLANGE DETAIL

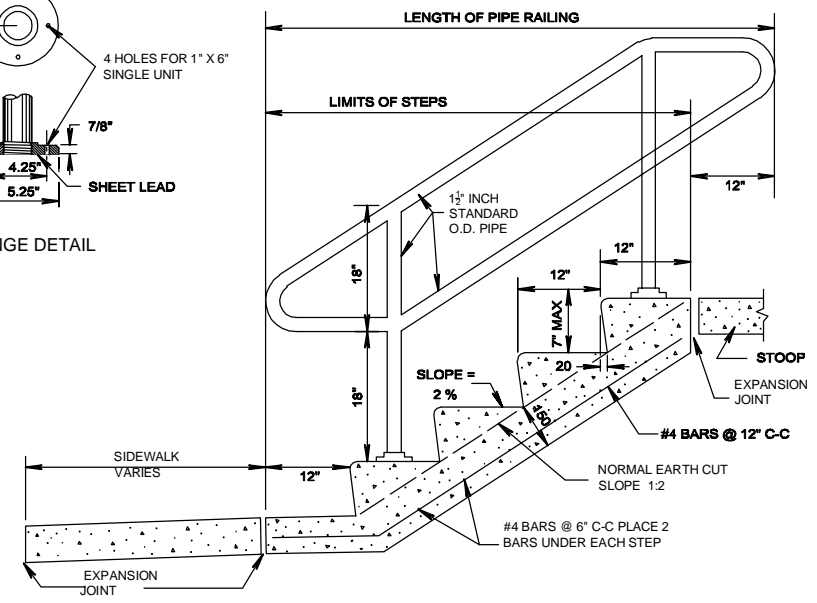

4 CONCRETE STAIRS
C-6.2 NOT TO SCALE

NOTE: THE EXACT LOCATION, WIDTHS, & NUMBER OF STEPS TO BE DETERMINED BY THE ENGINEER IN THE FIELD. STEEL REINFORCEMENT AND PIPE RAILING NOT REQUIRED ON STEPS WITH 2 RISERS OR LESS. MINIMUM WIDTH OF STEP EQUALS 12\"/>

Construction Details
Ridgewood Pool
City of Madison
Dane County, Wisconsin

Revisions	No.	Date	Description

Scale:	AS SHOWN
Date:	3/14/2022
Drawn By:	ALC
Project No:	190015
Sheet No:	C6.2

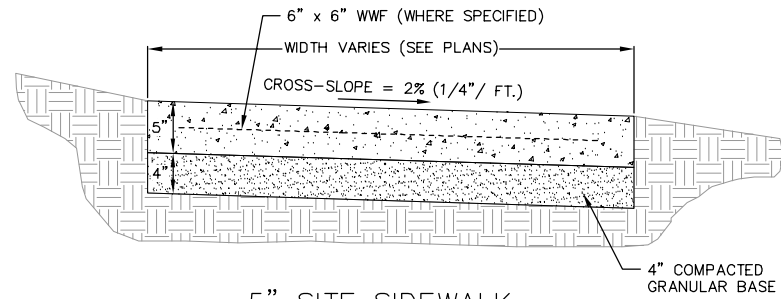

5" SITE SIDEWALK

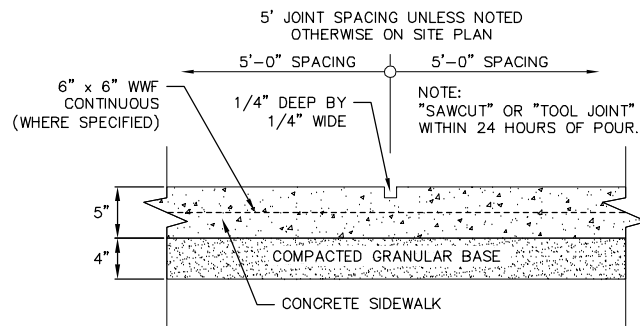

SIDEWALK CONTROL JOINT

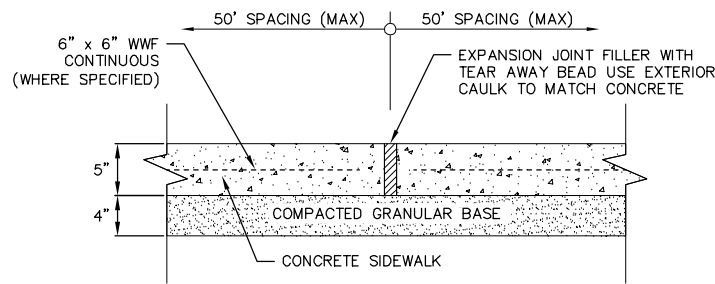

SIDEWALK EXPANSION JOINT

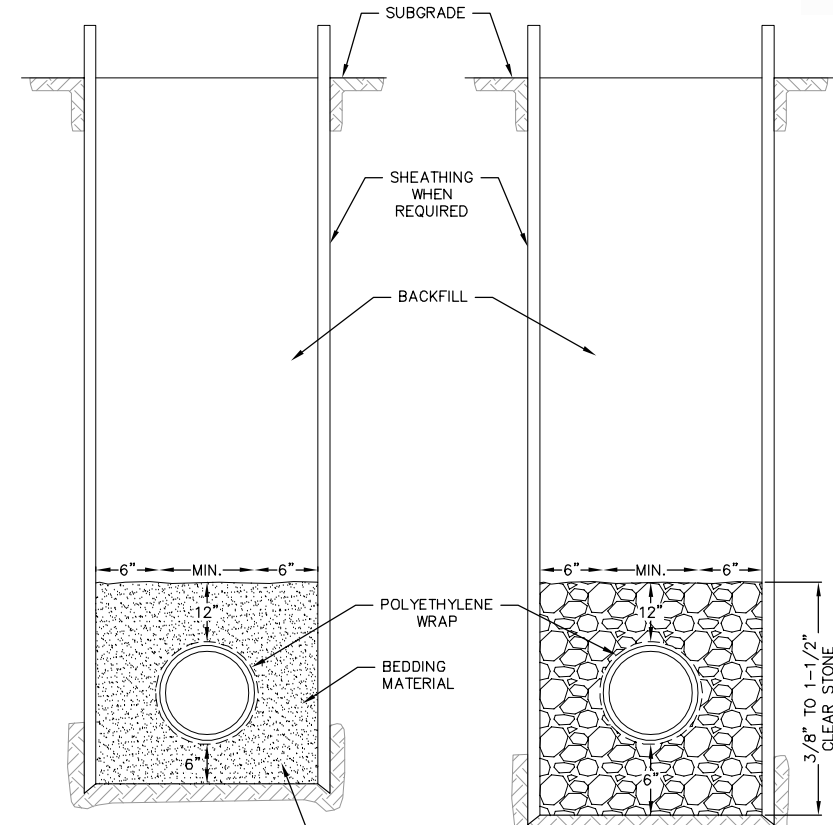

BEDDING MATERIAL TO BE PLACED BEFORE SETTING PIPE - 6" MINIMUM UNDER BARREL WITH 5" UNDER BELL

BEDDING MATERIAL

WATERMAIN:
3/8" TO 1/2" CRUSHED STONE, OR SAND

SANITARY SEWER:
3/8" TO 1-1/2" CLEAR STONE

STORM SEWER:
3/4" TO 1-1/2" CRUSHED STONE

DRY TRENCH CONDITION WET OR UNSTABLE CONDITION

4 STANDARD TRENCH SECTION
C-6.3 NOT TO SCALE

1 5" SIDEWALK
C-6.3 NOT TO SCALE

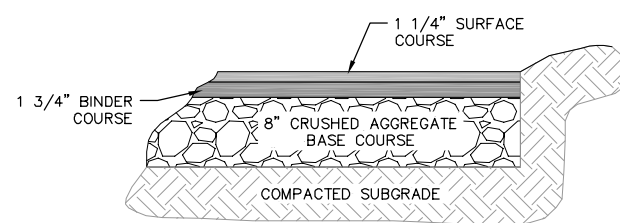

BITUMINOUS PAVEMENT PARKING LOT

2 SITE PAVEMENT
C-6.3 NOT TO SCALE

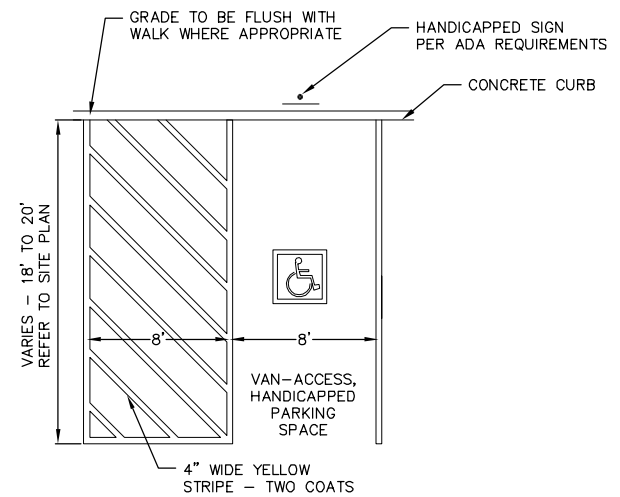

3 HANDICAP STRIPING
C-6.3 NOT TO SCALE

Construction Details
Ridgewood Pool
City of Madison
Dane County, Wisconsin

Revisions		Revisions	
No.	Date	No.	Date

Scale:	AS SHOWN
Date:	3/14/2022
Drawn By:	ALC
Project No:	190015
Sheet No:	C6.3

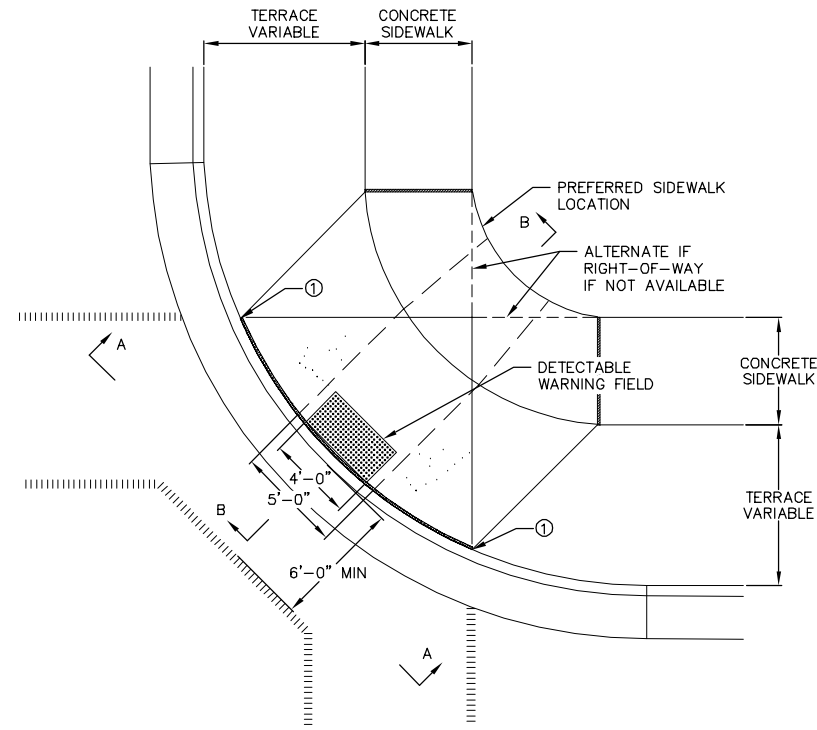

PLAN VIEW
TYPE 1 RAMP
(CENTER OF CORNER RADIUS)

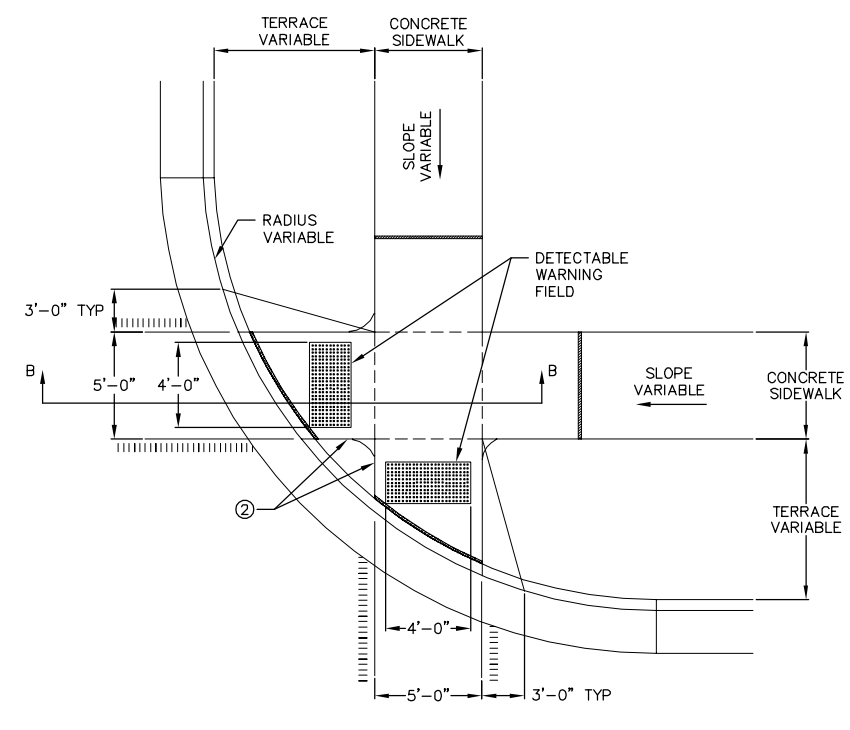

PLAN VIEW
TYPE 2 RAMP
(ON LINE WITH SIDEWALK)

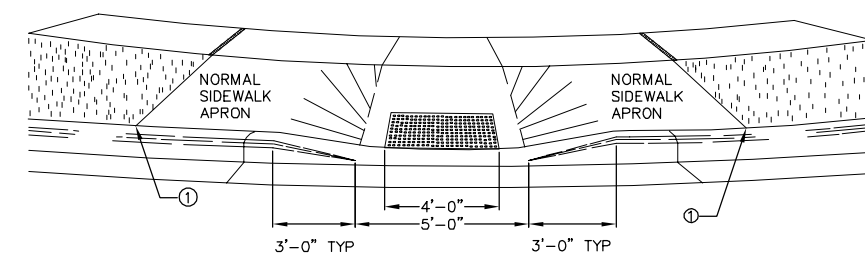





VIEW A-A

NOTE: MATERIALS AND METHOD OF CONSTRUCTION FOR TRUNCATED DOMES SHALL BE SPECIFIED IN SPECIAL PROVISIONS OR AS REQUIRED BY THE CITY ENGINEER

GENERAL NOTES:

- TYPE 2-A RAMPS SHALL BE USED IN NEW DEVELOPMENT UNLESS OTHERWISE APPROVED BY THE CITY ENGINEER.
- DETAILS OF CONSTRUCTION, MATERIALS, AND WORKMANSHIP NOT SHOWN ON THIS DRAWING SHALL CONFORM TO THE PERTINENT REQUIREMENTS OF THE STANDARD SPECIFICATIONS AND THE APPLICABLE SPECIAL PROVISIONS.
- RAMPS SHALL BE BUILT AT 12H:1V OR FLATTER, WHEN NECESSARY. THE SIDEWALK ELEVATION MAY BE LOWERED TO MEET THE HIGH POINT ON THE RAMP.
- DETECTABLE WARNING FIELD SHALL BE MEASURED AND PAID BY THE SQUARE FOOT AS "CURB RAMP DETECTABLE WARNING FIELD."
- CURB RAMP DETECTABLE WARNING FIELD MATERIALS AND DEVICES SHALL BE APPROVED BY THE CITY ENGINEER. THE COLOR OF THE DETECTABLE WARNING FIELD SHALL BE SAFETY YELLOW, AND IS INCIDENTAL TO THE BID ITEM OF "CURB RAMP DETECTABLE WARNING FIELD."
- SURFACE TEXTURE OF THE RAMP SHALL BE OBTAINED BY COURSE BROOMING TRANSVERSE TO THE SLOPE OF THE RAMP.
- ① THIS POINT IS AN EXTENSION OF OUTSIDE EDGE OF APPROACHING SIDEWALK WHERE IT MEETS THE BACK OF CONCRETE CURB
- ② WHEN THIS DISTANCE IS LESS THAN 6'-0" IT MAY BE DIFFICULT TO ACHIEVE A 12H:1V SLOPE, OR FLATTER, ON THE RAMP. REDUCE CURB HEIGHT IN TRIANGLE AREA TO ACHIEVE 12H:1V SLOPE, OR FLATTER, ON RAMP. 2" MINIMUM CURB HEIGHT.

LEGEND

	1/2" EXPANSION JOINT-SIDEWALK
	CONTRACTION JOINT FIELD LOCATED
	PAVEMENT MARKING CROSSWALK (WHITE)
	ALTERNATIVE LAYOUT

1 CURB RAMP DETAIL
C-6.4 NOT TO SCALE

2004

CITY OF MADISON
ENGINEERING DIVISION

**STANDARD CURB RAMPS
TYPES 1 AND 2**

STANDARD DETAIL DRAWING 3.03

Revisions		Revisions	
No.	Date	Description	Date

Scale: AS SHOWN
Date: 3/14/2022
Drawn By: ALC
Project No: 190015
Sheet No: C6.4

Construction Details
Ridgewood Pool
City of Madison
Dane County, Wisconsin

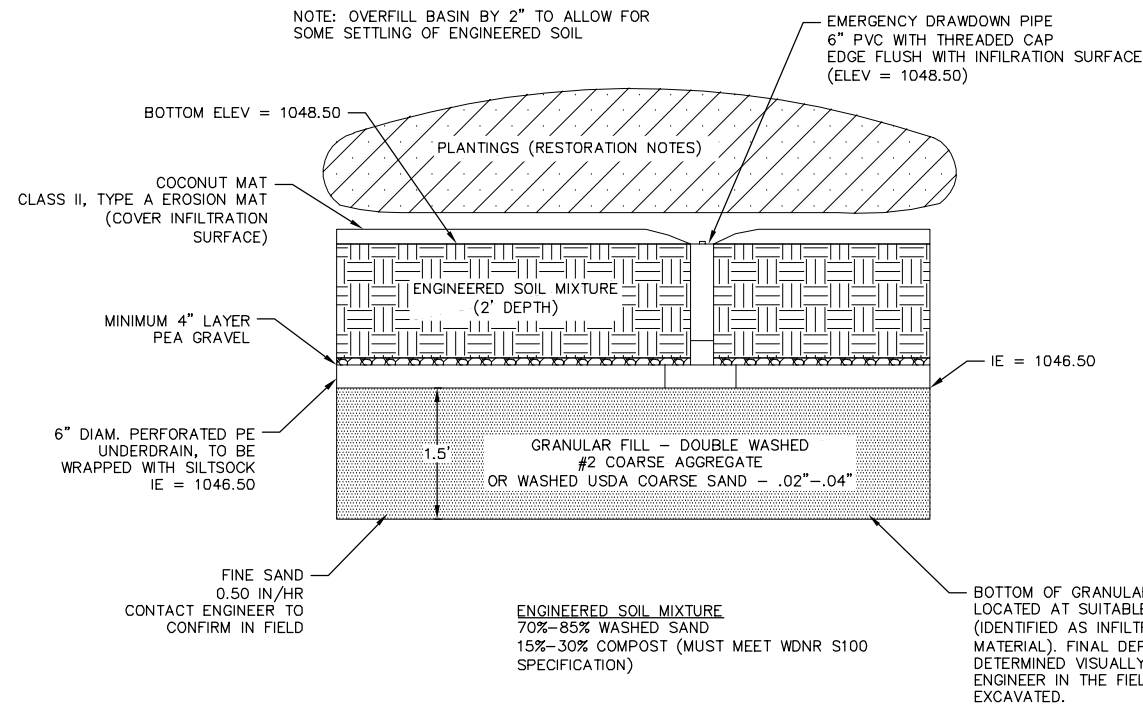

BIO-RETENTION AREA RESTORATION SPECIFICATIONS:

NOTE: BIO-RETENTION AREA MUST NOT BE CONSTRUCTED (INSTALLED) UNTIL THE SITE IS STABILIZED, I.E. THE GRASS COVER IS WELL ESTABLISHED.

BIO-RETENTION AREA MUST CONFORM TO WISCONSIN DNR TECHNICAL STANDARD 1004 (BIORETENTION FOR INFILTRATION)

USE RAINWATER GARDEN LIVE NATIVE PLANT PLUGS FROM AGRECOL (SUNNY, SHORT, OR MEDIUM STATURE) - OR ENGINEER APPROVED EQUAL.

PLANT PLUGS AT 1 PER SQUARE FOOT.

PLANTING, MULCH, AND MAINTENANCE NOTES:

PLANTING SHOULD TAKE PLACE BETWEEN AVAILABILITY OF PLANTS IN SPRING AND JUNE 30TH, OR BETWEEN SEPTEMBER 1ST AND OCTOBER 15TH. IF PLANTED JULY 1ST THROUGH AUGUST 31ST, HEAVILY WATER THE PLANTS AT THE TIME THEY ARE PLANTED, AND EVERY OTHER DAY FOR A TOTAL OF 4 WATERINGS. A RAIN EVENT GREATER THAN 0.5 INCHES CONSTITUTES A WATERING. IF PLANTED SEPTEMBER 1ST THROUGH OCTOBER 15TH, PLACE CERTIFIED WEED-FREE STRAW MULCH AT 3" MINIMUM THICKNESS BETWEEN PLANTS TO HELP PREVENT FROST HEAVE. IF PLANTING IS TO OCCUR AFTER OCTOBER 15TH, IT MUST BE POSTPONED UNTIL THE FOLLOWING SPRING (MAY). FOR THE FIRST 3 YEARS AFTER PLANTING, SPOT TREAT THE AREA WITH HERBICIDE TO REMOVE WEEDS.

RESTORATION OF THE INFILTRATION AREA (NOT INCLUDING SIDE SLOPES):

1. OVER-EXCAVATE THE AREA TO INFILTRATIVE LAYER TO BE DETERMINED IN THE FIELD, DURING EXCAVATION, BY DESIGN ENGINEER.
2. CHISEL PLOW, OR ROTO-TILL THE BASE OF THE AREA TO BREAK UP ANY HARDPAN IN THE NATIVE SOIL LAYER.
3. PLACE WASHED SAND (FREE OF P200 PARTICLES) TO 46 INCHES BELOW GROUND SURFACE (IF REQUIRED).
4. PLACE 24 INCHES OF ENGINEERED SOIL, COMPRISED OF:
70-85% WASHED SAND
15-30% COMPOST (MUST MEET WDNR S100 SPECIFICATION)
5. PLANT PLUG, MULCH, WATER, AND MAINTAIN AS DIRECTED ABOVE.

1 **BIO-RETENTION BASIN**
C-6.5 NOT TO SCALE

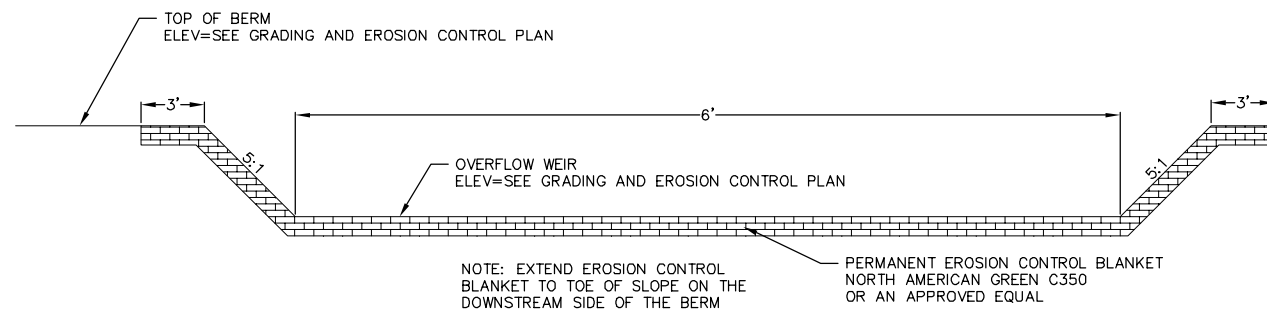

2 **OVERFLOW WEIR**
C-6.5 NOT TO SCALE

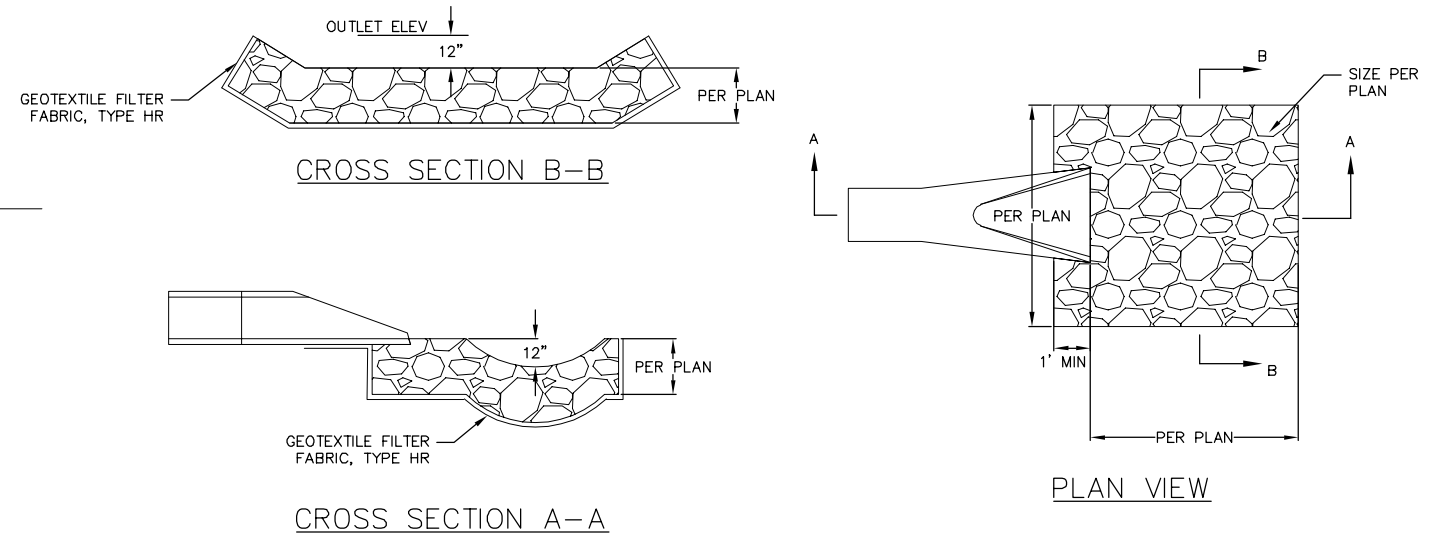

3 **RIP-RAP OUTLET**
C-6.5 NOT TO SCALE

Construction Details
Ridgewood Pool
City of Madison
Dane County, Wisconsin

Revisions		Revisions	
No.	Date	Description	No.

Scale: AS SHOWN

Date: 3/14/2022

Drawn By: ALC

Project No: 190015

Sheet No: C6.5

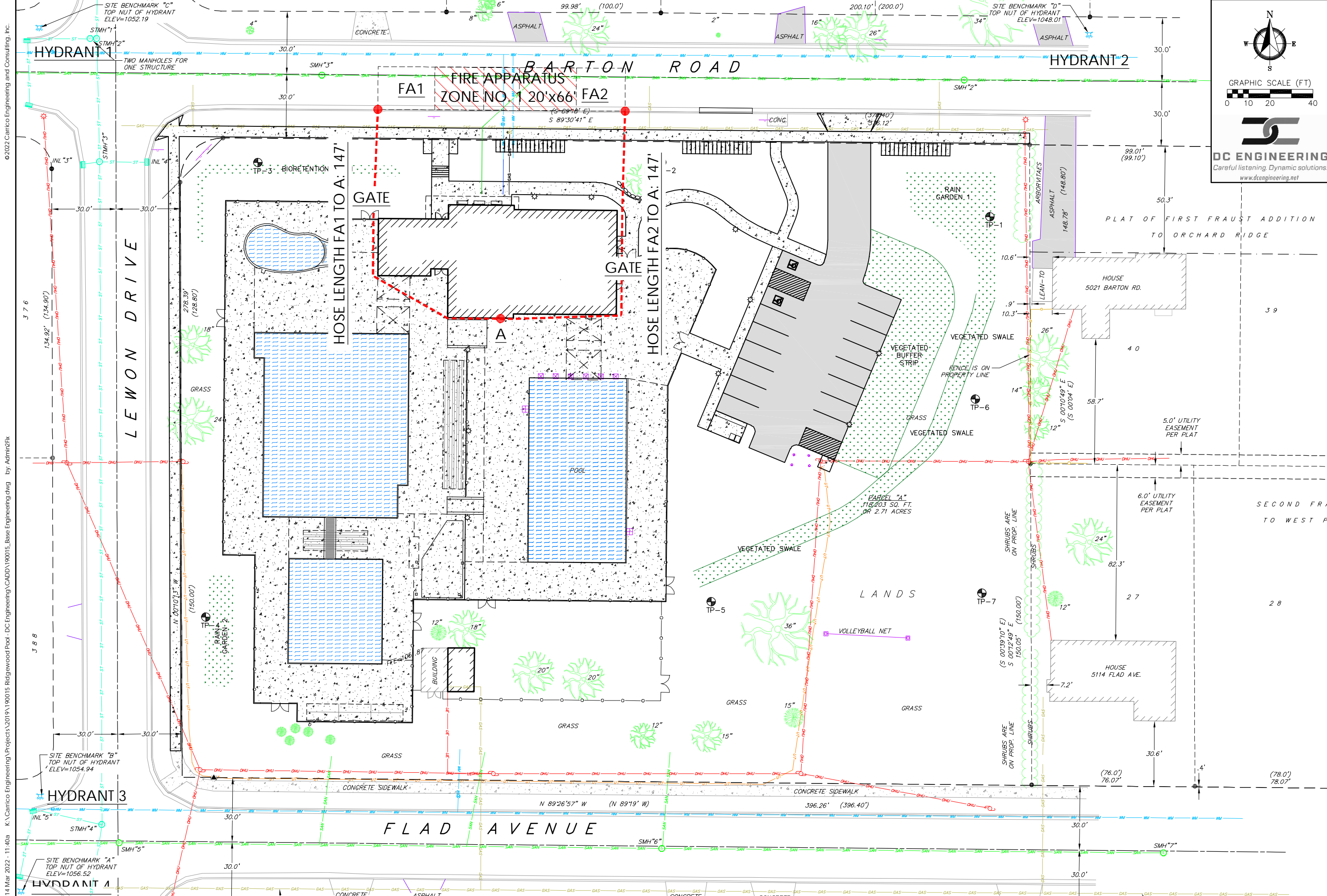

GRAPHIC SCALE (FT)

DC ENGINEERING

 Careful listening. Dynamic solutions.

 www.dcengineering.net

Carrico Engineering

 (608) 832-6352 | carricoengineering.com

Fire Access Plan
 Ridgewood Pool
 City of Madison
 Dane County, Wisconsin

Revisions		Revisions	
No.	Date	Description	Date

Scale: AS SHOWN
 Date: 3/14/2022
 Drawn By: ALC
 Project No: 190015
 Sheet No: C7.0

14 Mar 2022 - 11:40a K:\Carrico Engineering\Projects\2019\190015 Ridgewood Pool - DC Engineering\CADD\190015_Base Engineering.dwg by Admin2Fix

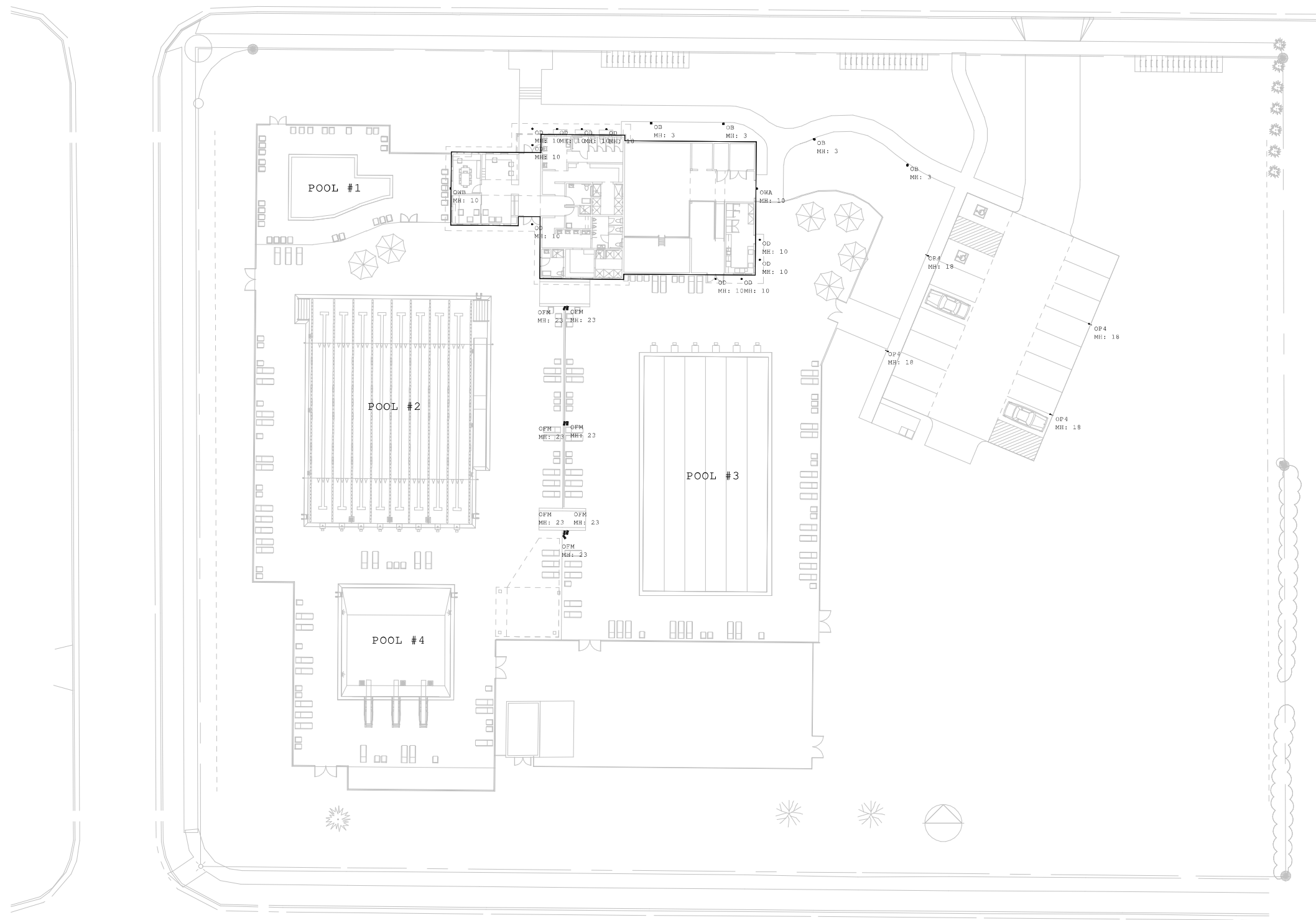

Scale: 1 inch= 20 Ft.

Luminaire Schedule								
Symbol	Qty	Label	Manufacturer	Description	Arrangement	Lum. Lumens	Lum. Watts	LLF
⊙	4	OB	HUBBELL OUTDOOR	FN2-12LU-4K	SINGLE	941	26.9	0.900
⊙	10	OD	PRESCOLITE	LFR-4RD-M-10L40K8XW-DM1_LFR-4RD-T-CL-SS	SINGLE	903	7.6	0.900
⊙	7	OFM	HUBBELL OUTDOOR	RFL5-360L-265-4K7-M	SINGLE	28983	252	0.900
⊙	4	OP4	HUBBELL OUTDOOR	RAR1-80L-39-4K7-4W-UNV	SINGLE	5210	37.98	0.900
⊙	1	OWA	HUBBELL OUTDOOR	RWL1-48L-10-4K7-3-UNV	SINGLE	1355	10.1	0.900
⊙	1	OWB	HUBBELL OUTDOOR	RWL1-48L-20-4K7-4W-UNV	SINGLE	2671	19.9	0.900

RIDGEWOOD POOL

E1.0 - SITE LIGHTING PLAN

Project #: 37574
Date: 2/23/2022

Paper Size: ARCH D - 24x36

Calculated light levels shown are estimates based on information available at time of layout request. Due to unknown site conditions JTH Lighting assumes no responsibility for installed light levels.



Eastern Wisconsin
2625 S Greeley Street
Milwaukee, WI 53207
(p) 414-635-9900
www.jthlighting.com

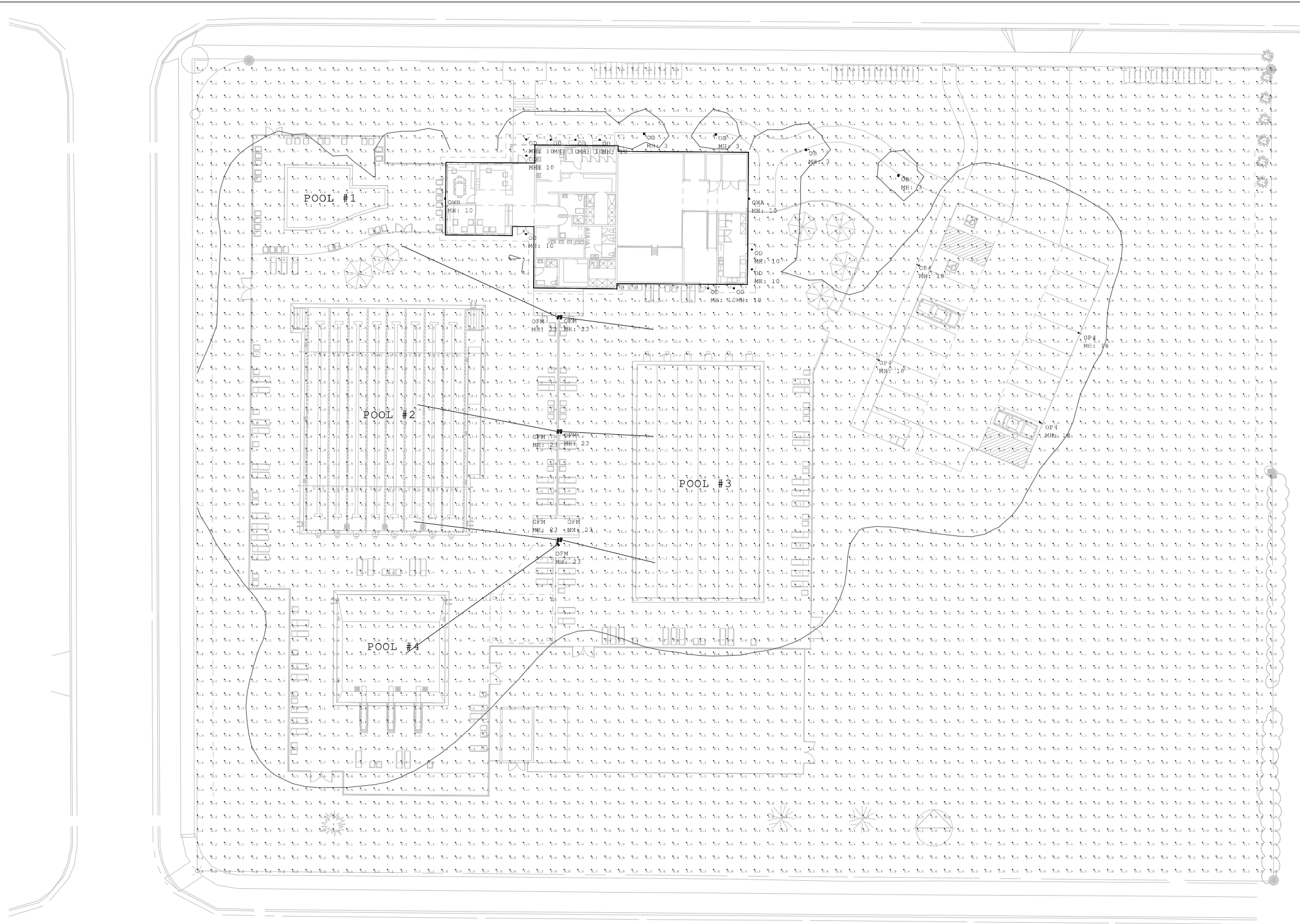

Scale: 1 inch= 20 Ft.

Calculation Summary

Label	CalcType	Units	Avg	Max	Min	Avg/Min	Max/Min
SITE	Illuminance	Fc	1.56	34.1	0.0	N.A.	N.A.
PARKING	Illuminance	Fc	2.27	3.2	0.9	2.52	3.56
POOL #1	Illuminance	Fc	1.57	3.6	0.9	1.74	4.00
POOL #2	Illuminance	Fc	4.60	18.0	0.9	5.11	20.00
POOL #3	Illuminance	Fc	6.16	25.8	1.2	5.13	21.50
POOL #4	Illuminance	Fc	3.53	8.8	1.5	2.35	5.87

Luminaire Schedule

Symbol	Qty	Label	Manufacturer	Description	Arrangement	Lum. Lumens	Lum. Watts	LLF
⊙	4	OB	HUBBELL OUTDOOR	FN2-12LU-4K	SINGLE	941	26.9	0.900
○	10	OD	PRESCOLITE	LFR-4RD-M-10L40K8XW-DM1_LFR-4RD-T-CL-SS	SINGLE	903	7.6	0.900
□	7	OFM	HUBBELL OUTDOOR	RFL5-360L-265-4K7-M	SINGLE	28983	252	0.900
⊞	4	OP4	HUBBELL OUTDOOR	RAR1-80L-39-4K7-4W-UNV	SINGLE	5210	37.98	0.900
□	1	OWA	HUBBELL OUTDOOR	RWL1-48L-10-4K7-3-UNV	SINGLE	1355	10.1	0.900
□	1	OWB	HUBBELL OUTDOOR	RWL1-48L-20-4K7-4W-UNV	SINGLE	2671	19.9	0.900

1. Lighting Reflectance of 80/50/20 used unless noted otherwise
2. Interior calc points shown at 30" A.F.F. unless noted otherwise
3. Exterior calc points shown at grade unless noted otherwise
4. Emergency egress calc points shown at 0" A.F.F.
5. Photometric drawings are for Design purposes only, not for Construction documents

Eastern Wisconsin
2625 S Greeley Street
Milwaukee, WI 53207
(p) 414-635-9900
www.jthlighting.com



Calculated light levels shown are estimates based on information available at time of layout request. Due to unknown site conditions JTH Lighting assumes no responsibility for installed light levels.

Project #: 37574
Date: 2/23/2022
Paper Size: ARCH D - 24x36

**RIDGEWOOD POOL
E2.0 - PHOTOMETRIC PLAN**

**RIDGEWOOD
POOL**

Drawn By: GQP
Checked By: GQP
File: 22_0312 LP
Issued For: Plan Com
Issue Date: 03/14/22
Project No. 22_RHN_01

OPTION



Sheet Name _____

Landscape Plan

Sheet Number _____

L1.00

File: C:\Garret\Projects\21_TBA_01_Ridgewood Pool\Cad\22_0312_LP.dwg Layout: L1.0 User: gaper Plotted: Mar 14, 2022 - 9:55am

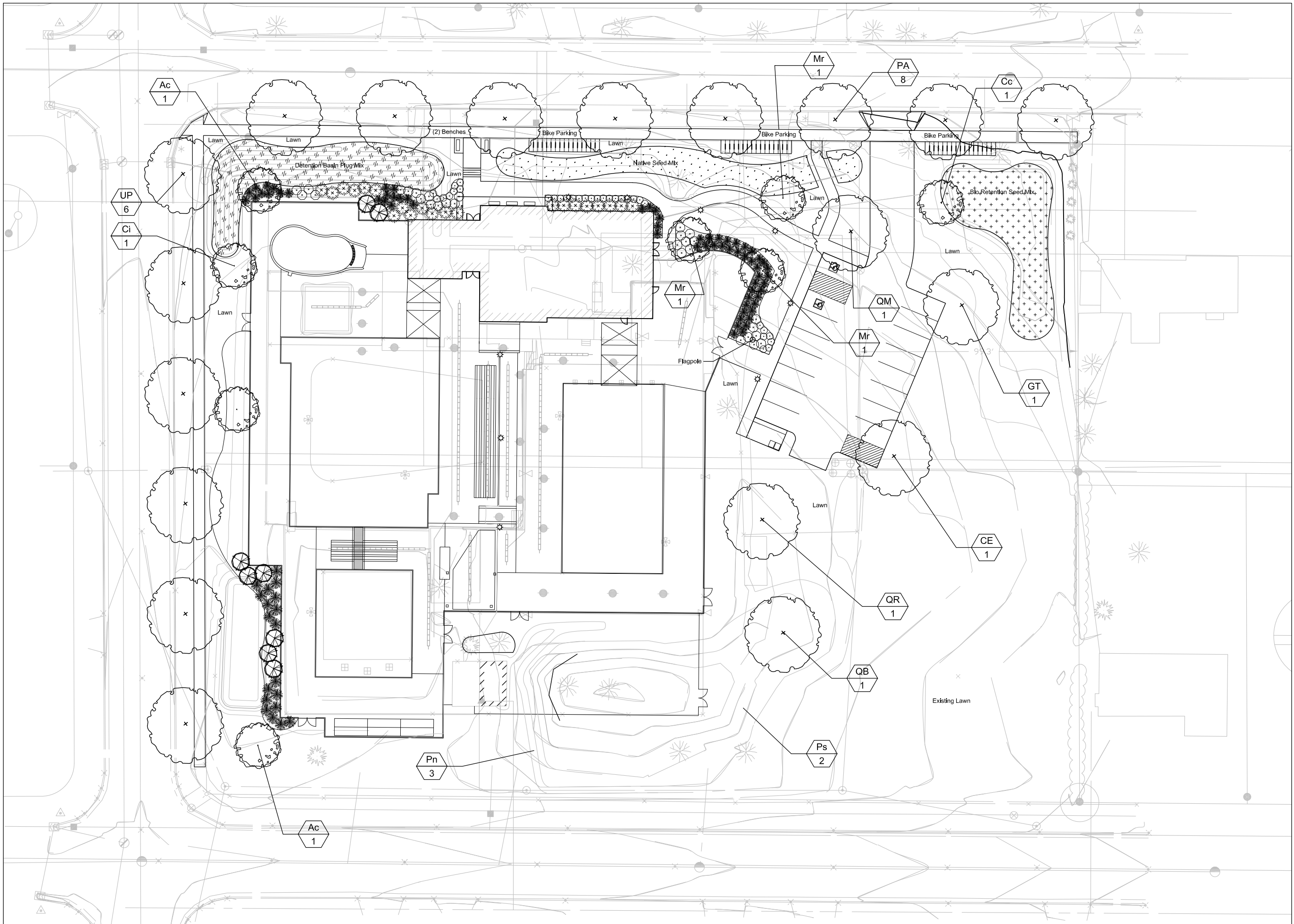

**RIDGEWOOD
POOL**

Drawn By: GQP
Checked By: GQP
File: 22_0125 TH
Issued For: MP
Issue Date: 01/31/22
Project No. 22_RHN_01

OPTION



Sheet Name
**Landscape
Enlargement Plan**

Sheet Number

L2.00

File: C:\Garret\Projects\21_TBA_01_Ridgewood Pool\Cad\22_0312_LP.dwg Layout: L2.0 User: gqper Plotted: Mar 14, 2022 - 10:06am

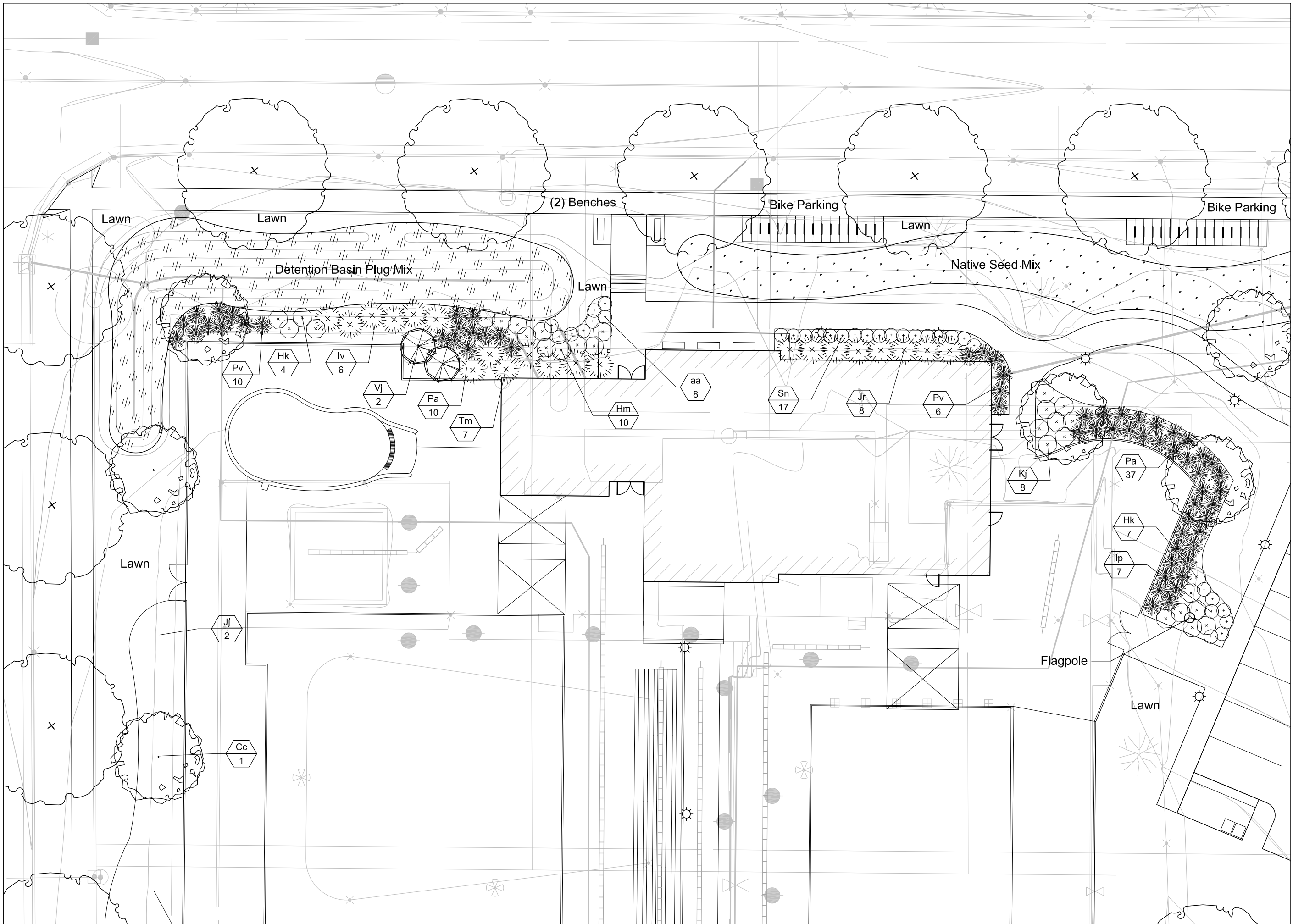

File: C:\Garret\Projects\21_TBA_01_Ridgewood Pool\22_0312_LP.dwg Layout: L2.1 User: gqper Plotted: Mar 14, 2022 - 10:06am

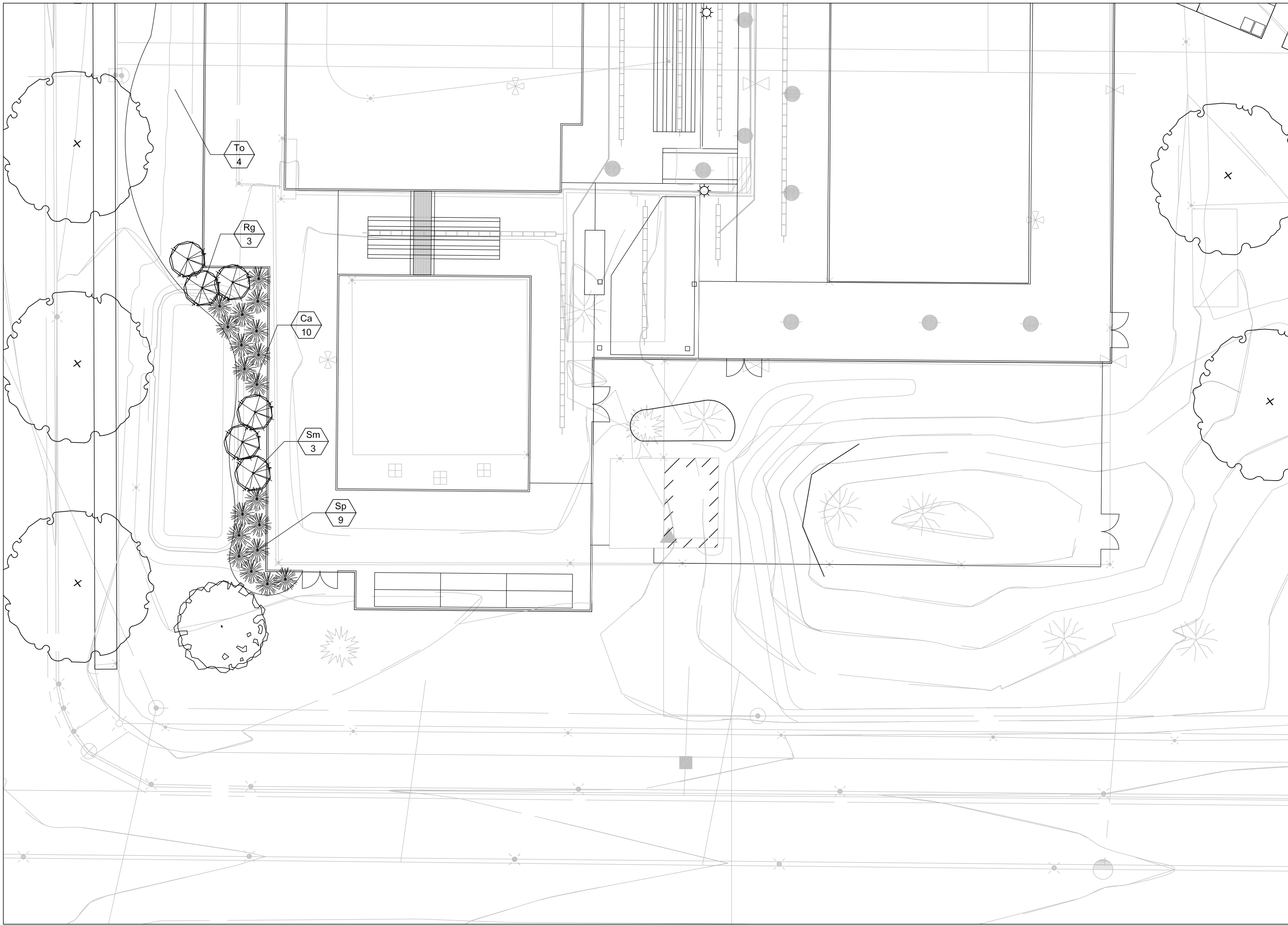

**RIDGEWOOD
POOL**

Drawn By: GQP
Checked By: GQP
File: 22_0125 TH
Issued For: MP
Issue Date: 01/31/22
Project No. 22_RHN_01

OPTION



Sheet Name
**Landscape
Enlargement Plan**

Sheet Number

L2.10

LANDSCAPE PLANT LEGEND

Symbol	Botanical name	Common Name	Size	Root	Quantity	Remarks
SHADE TREES						
CE	Celltis occidentalis	Common Hackberry	3" Cal.	B&B		
GT	Gleditsia tricanthos 'Skyline'	Skyline Honeylocust	3" Cal.	B&B		
PA	Platanus x acerfolia	American Sycamore	3" Cal.	B&B		
QB	Quercus bicolor	Swamp White Oak	3" Cal.	B&B		
QM	Quercus macrocarpa	Bur Oak	3" Cal.	B&B		
QR	Quercus rubra	Red Oak	3" Cal.	B&B		
UP	Ulmus x 'Pioneer'	Pioneer Elm	3" Cal.	B&B		
EVERGREEN TREES						
PS	Pinus Strobus	Eastern White Pine	6'-8'	B&B		
PN	Pinus nigra	Austrian Pine	6'-8'	B&B		
ORNAMENTAL TREES						
AC	Amelanchier x grandiflora 'Autumn Brilliance'	Autumn Brilliance Serviceberry	5-6' HT.	B&B		
CC	Carpinus caroliniana	American Hornbeam (Musclewood)	2"-3" Cal.	B&B		
CI	Crataegus crus-galli var inermis	Thornless Cockspur Hawthorn	2" Cal.	B&B		
MR	Malus 'Red Jewel'	Red Jewel Crabapple	2" Cal.	B&B		
SHRUBS						
Hm	Hydrangea macropylla 'Bailmer'	Endless Summer Hydrangea	3 gal	Pot		
Hk	Hypericum kalmianum	St. Johns Wort	2 gal	Pot		
Kj	Kerria Japonica	Japenese Kerria	2 gal.	Pot		
Rg	Rhus glabara	Smooth Sumac	5 gal	Pot		
Sn	Spirea x bumalda 'A.W.	Anthony Waterer Spirea	2 gal	Pot		
Sm	Syringa patula 'Miss Kim'	Miss Kim Lilac	3 gal	Pot		
Vj	Viburnum x juddi	Judd Viburnum	5 gal	B&B		
GRASSES						
Ca	Calamagrostis x acutifolia 'Karl Foerster'	Karl Foerster's Feather Reed Grass	1 Gal.	CG		
Pa	Pennisetum alopecuroides 'Hameln'	Dwarf Fountain Grass	2 Gal.	CG		
Pv	Panicum virgatum 'Shenandoah'	Shenandoah Switch Grass	2 Gal.	CG		
Sp	Sporobolus heterolepis	Prairie Dropseed	2 Gal.	CG		
EVERGREEN SHRUBS						
Iv	Illex veticillata	Winterberry	5 Gal.	CG		
Jr	Juniperus ramlosa	Ramlosa juniper	5 Gal.	CG		
Tm	Taxus tauntonii	Taunton yew	5 Gal.	CG		
Jj	Juniperus x 'JNBlue Select'	Star Power Juniper	6' Ht.	BB		
To	Thuja occidentalis 'Dark Green'	Dark Green Arborvitae	6' Ht.	BB		
PERENNIALS						
aa	Astilbe x arendsii 'Fanal'	Fanal Astilbe	1 Gal.	Container		15"0.C.
lp	Liatrus pyncostachya	Prairie Blazingstar	1 Gal.	Container		18"0.C.

EMERGENT PLUGS

PLUGS BY AGRECOL, INC. OR EQUAL. INDIVIDUAL POTS TO BE 2.5" x 2.5" x 3.5". USE FULL TRAYS OF PLANTS PER EACH SPECIES. CHOOSE FROM THE FOLLOWING:

Grasses, Sedges, & Rushes	
Calamagrostis canadensis	Blue Joint Grass
Carex comosa	Bristly Sedge
Carex crinita	Fringed Sedge
Carex hystericina	Porcupine Sedge
Glyceria grandis	Reed Manna Grass
Glyceria striata	Fowl Manna Grass
Juncus effusus	Common Rush
Leersia oryzoides	Rice Cut Grass
Scirpus acutus	Hard-Stem Bulrush
Scirpus atrovirens	Dark-Green Bulrush
Scirpus cyperinus	Wool Grass
Scirpus fluviatilis	River Bulrush
Scirpus pendulus	Red Bulrush
Scirpus validus	Great Bulrush
Spartina pectinata	Prairie Cordgrass

BIO RETENTION SEED MIX

The species in this mix designed by Prairie Nursery of Westfield, Wisconsin (or approved equal) grow naturally in medium-moist prairies, making them the perfect for temporarily flooded areas that also dry out in summer. Designed for planting in basins that are flooded for 24-48 hours, and then drain out. This mix is particularly well adapted to loamy and clay soils. For detention basins in sandy soils, we recommend planting our Tall Prairie for Dry Soils Seed Mix.

WILDFLOWERS: Nodding Pink Onion, Red Milkweed, New England Aster, White False Indigo, Pale Indian Plantain, Wild Senna, Joe Pye Weed, Boneset, Dogtooth Daisy, Ox Eye Sunflower, Wild Iris, Blue Flag Iris, Prairie Blazingstar, Dense Blazingstar, Great Blue Lobelia, Bergamot, Yellow Coneflower, Black Eyed Susan, Sweet Black Eyed Susan, Brown Eyed Susan, Rosinweed, Cupplant, Prairie Dock, Ohio Goldenrod, Stiff Goldenrod, Blue Vervain, Ironweed, Golden Alexanders

GRASSES: Big Bluestem, Bebb's Sedge, Bottlebrush Sedge, Porcupine Sedge, Awl Fruited Sedge, Fox Sedge, Canada Wild Rye, Virginia Wild Rye, Switchgrass, Dark Green Bulrush, Indiangrass, Prairie Cordgrass, Annual Rye Nurse Crop

Contains at least 20 wildflowers and 8 or more grasses, sedges & bulrushes, plus annual rye

NATIVE SEED MIX

SEED BY AGRECOL, INC. OR EQUAL. COVER CROP TO BE ANNUAL RYE. MULCH WITH SEEDLESS MARSH HAY.

Wildflowers: Nodding Onion, Leadplant, Butterfly Weed, Sky-Blue Aster, Smooth Blue Aster, New England Aster, Partridge Pea, Prairie Coreopsis, White Prairie Clover, Purple Prairie Clover, Pale Purple Coneflower, Purple Coneflower, Rattlesnake Master, Early Sunflower, Prairie Blazing Star, Wild Bergamot, Smooth Penstemon, Prairie Cinquefoil, Mountain Mint, Yellow Coneflower, Black-Eyed Susan, Sweet Black-Eyed Susan, Compass Plant, Showy Goldenrod, Spiderwort, Culver's Root

Grasses, Sedges & Rushes: Side Oats Grama, Copper-Shouldered Oval Sedge, Canada Wild Rye, Virginia Wild Rye, June Grass, Little Bluestem



CITY OF MADISON LANDSCAPE WORKSHEET

Section 28.142 Madison General Ordinance

Project Location / Address 5109 Barton Road, Madison, WI 53711

Name of Project Ridgewood Pool

Owner / Contact Scott Stewart

Contact Phone _____ Contact Email scott.stewart34@gmail.com

**** Landscape plans for zoning lots greater than ten thousand (10,000) square feet in size MUST be prepared by a registered landscape architect. ****

Landscape Calculations and Distribution

Required landscaped areas shall be calculated based upon the total developed area of the property. Developed area is defined as all parts of the site that are not left in a natural state within a single contiguous boundary, including building footprints, parking and loading areas, driveways, internal sidewalks, patios, and outdoor activity areas. Developed area does not include other land within required setbacks and natural areas on the same property that are left undisturbed.

- (a) One (1) landscape unit shall be provided for each three hundred (300) square feet of developed area, with the exception of the IL and the IG districts as specified in (b) below.

Total square footage of developed area 94,200

Developed area divided by three hundred (300) square feet = 313 Landscape Units

- (b) Within the Industrial - Limited (IL) and Industrial - General (IG) districts, one (1) landscape unit shall be provided for every six hundred (600) square feet of developed area.

Total square footage of developed area _____

Developed area divided by six hundred (600) square feet = _____ Landscape Units

- (c) One landscape unit consists of five (5) landscape points. Landscape points are calculated as shown in the following table.

Landscape units multiplied by five (5) landscape points = 1565 Total Points Required

Tabulation of Points and Credits

Use the table to indicate the quantity and points for all existing and proposed landscape elements. Calculations yielding a fraction up to one-half (1/2 or 0.5) shall be rounded down to the nearest whole number; fractions of more than one half (1/2) shall be rounded up.

Plant Type/ Element	Minimum Size at Installation	Points	Credits/ Existing Landscaping		New/ Proposed Landscaping	
			Quantity	Points Achieved	Quantity	Points Achieved
Overstory deciduous tree	2½ inch caliper	35	8	280	19	665
Ornamental tree	1 1/2 inch caliper	15			8	120
Evergreen tree	3 feet tall	15	2	30	11	165
Shrub, deciduous	18" or 3 gallon container size	2			37	74
Shrub, evergreen	18" or 3 gallon container size	3			21	63
Ornamental grasses	18" or 3 gallon container size	2			81	162
Ornamental/ decorative fencing or wall	n/a 567	4 per 10 lineal ft.				
Sub Totals				310		1249

Total Number of Points Provided 1559

3/2013

1

- * Native seeding and native plugs have not been included in the points calculation. Over 2200 square feet of native plugs are to be installed in the bio retention basin. 1764 square feet of native seeding is to be installed in the rain gardens and over 2400 square feet of native grasses and forbes are to be installed in the front lawn. This should offset the 7 point deficiency in the points calculation



design studio etc.

Landscape Architects
330 W. Lakeside Street
Madison, WI 53715

gqperry@gmail.com

P 608.358.6344

Professional Seal

Revision _____ Date _____

Project Name _____

**RIDGEWOOD
POOL**

Drawn By: GQP

Checked By: GQP

File: 22_0125 TH

Issued For: MP

Issue Date: 01/31/22

Project No. 22_RHN_01

OPTION

Sheet Name

Landscape Details

Sheet Number

L3.00

installed in the rain gardens and over 2400 square feet of native grasses and forbes are to be installed in the front lawn. This should offset the 7 point deficiency in the points calculation

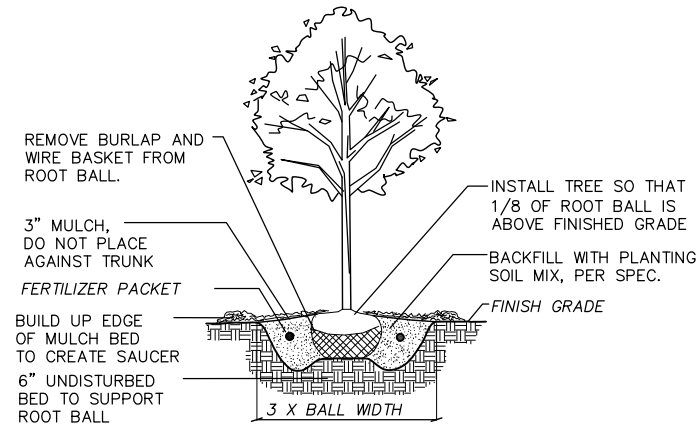

1 B&B TREE PLANTING DETAIL NTS

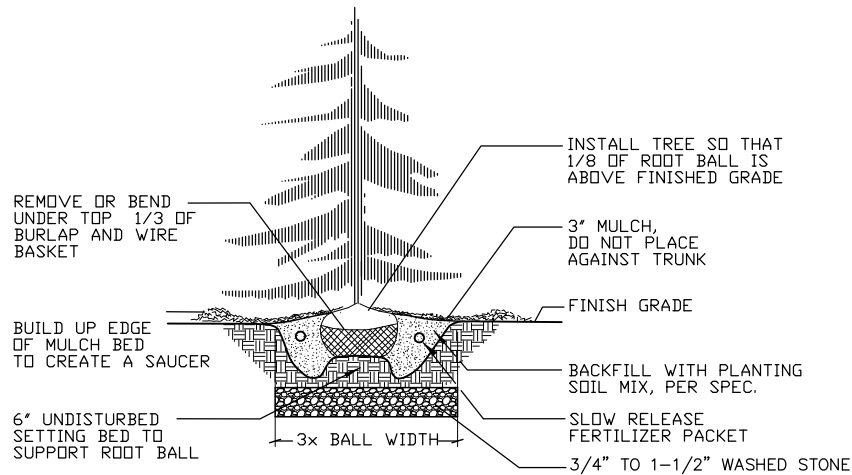

2 B&B EVERGREEN TREE PLANTING DETAIL NTS NTS

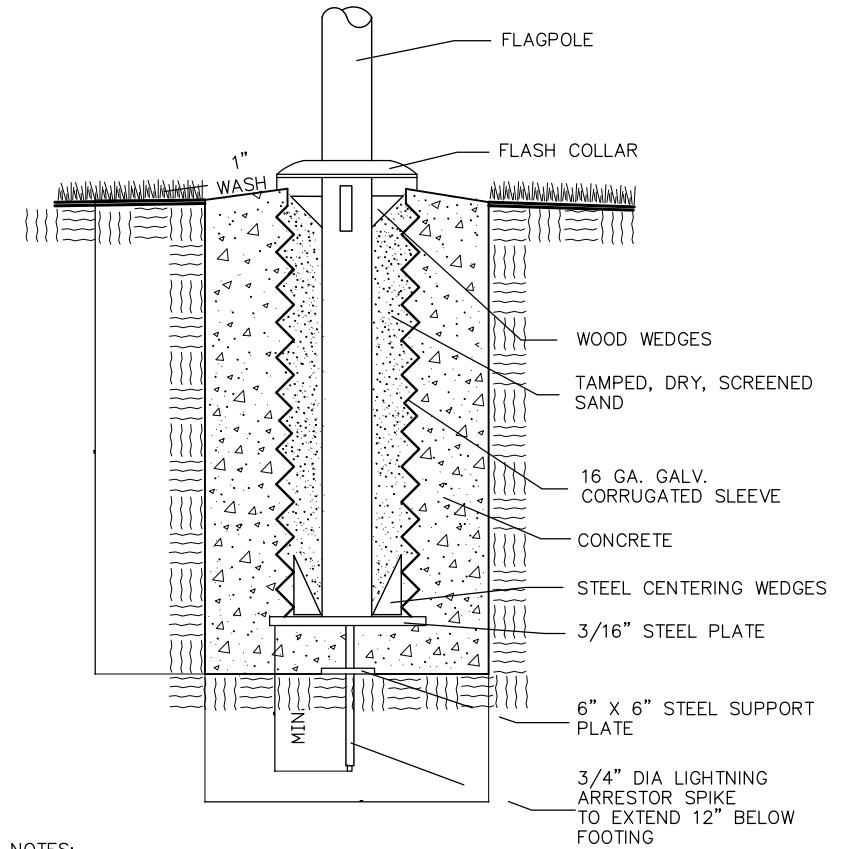

- NOTES:
1. INSTALLATION AND FOOTINGS SHALL BE DONE IN ACCORDANCE WITH MANUFACTURER'S SPECIFICATIONS AND SOIL CONDITIONS.
 2. MATERIAL WITHIN A 3' PERIMETER OF FLAG POLE BASE SHALL BE ENGINEERED FILL OR NATIVE SOIL. TOP 1' OF MATERIAL SHALL BE STANDARD FILL WITH TOP SOIL.

5 FLAGPOLE MOUNTING DETAIL - SECTION N.T.S.

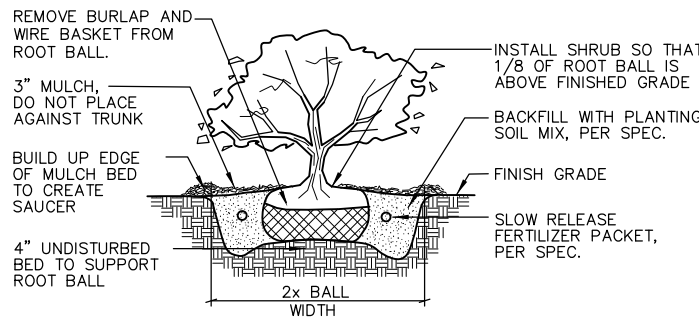

3 SHRUB PLANTING DETAIL NTS

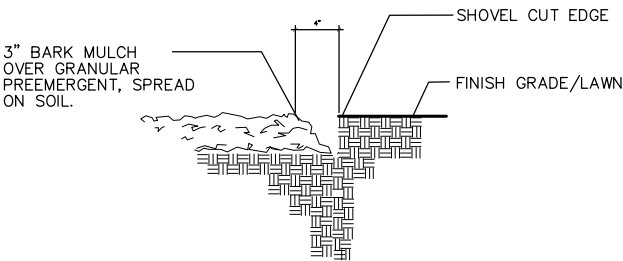

4 BARK MULCH/SHOVEL CUT EDGE DETAIL NTS

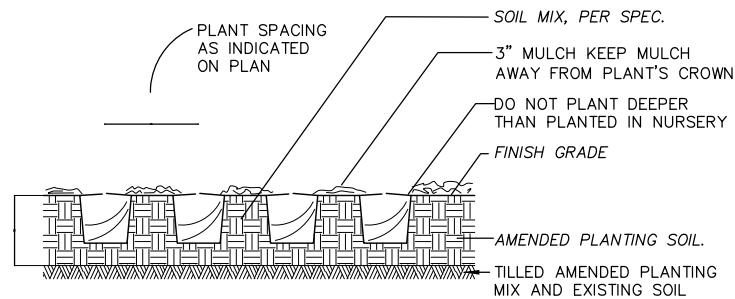

6 GROUNDCOVER / PERENNIAL PLANTING DETAIL NTS

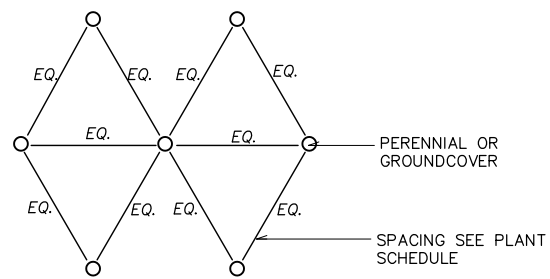

7 PERENNIAL/GROUNDCOVER SPACING DETAIL NTS

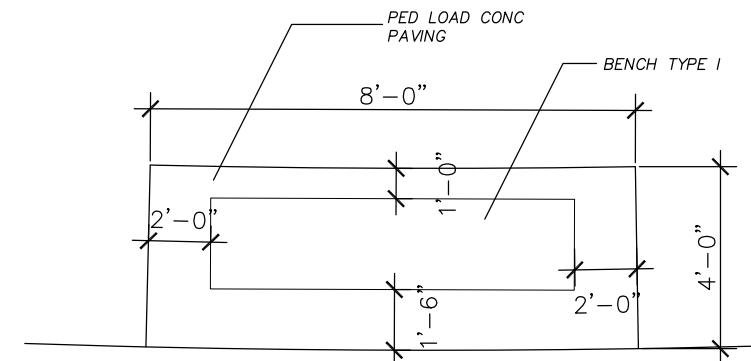

7 BENCH INSTALLATION - PLAN NTS

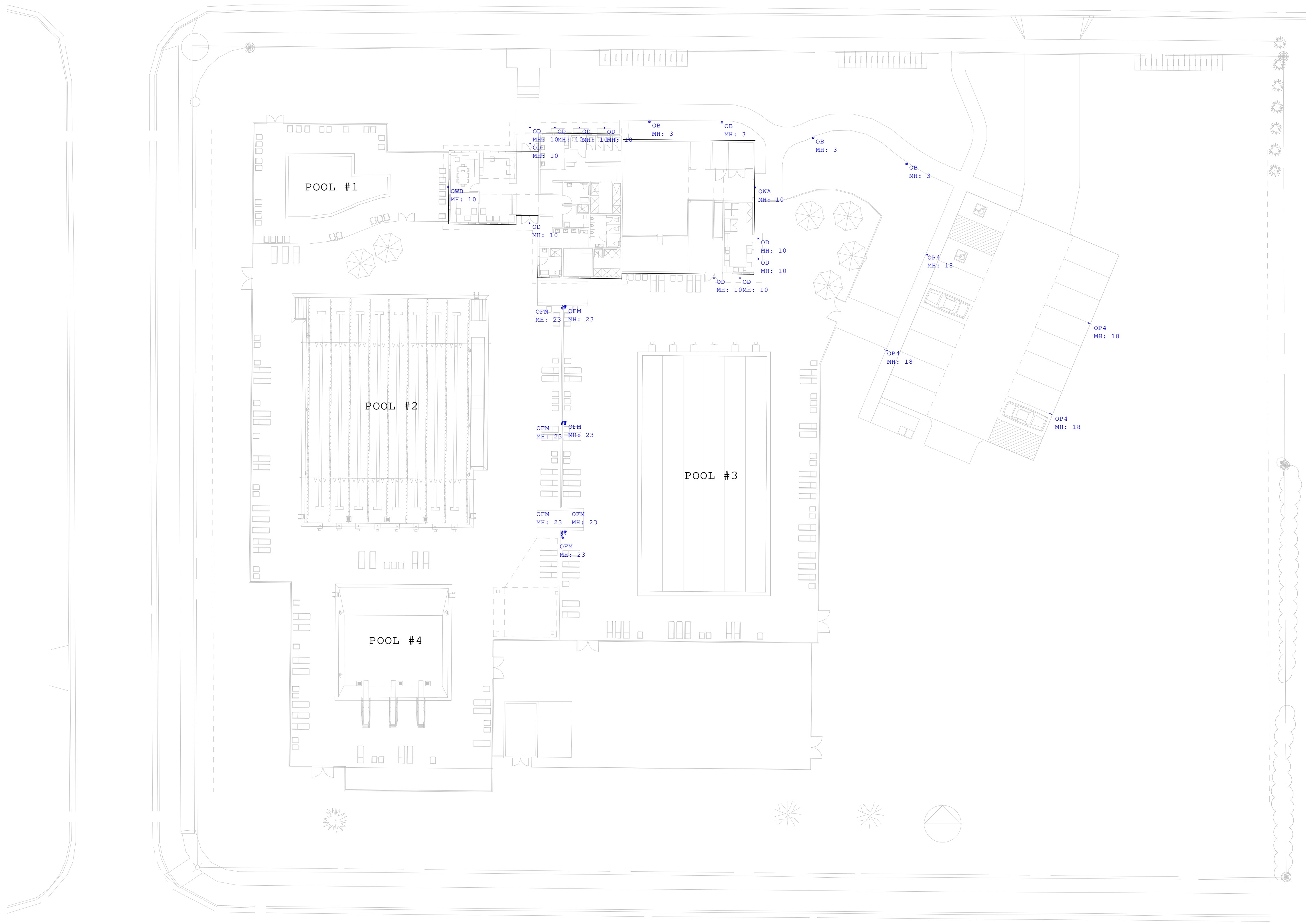

Scale: 1 inch= 20 Ft.

Luminaire Schedule								
Symbol	Qty	Label	Manufacturer	Description	Arrangement	Lum. Lumens	Lum. Watts	LLF
⊙	4	OB	HUBBELL OUTDOOR	FN2-12LU-4K	SINGLE	941	26.9	0.900
○	10	OD	PRESCOLITE	LFR-4RD-M-10L40K8XW-DM1_LFR-4RD-T-CL-SS	SINGLE	903	7.6	0.900
□	7	OFM	HUBBELL OUTDOOR	RFL5-360L-265-4K7-M	SINGLE	28983	252	0.900
—□	4	OP4	HUBBELL OUTDOOR	RAR1-80L-39-4K7-4W-UNV	SINGLE	5210	37.98	0.900
□	1	OWA	HUBBELL OUTDOOR	RWL1-48L-10-4K7-3-UNV	SINGLE	1355	10.1	0.900
□	1	OWB	HUBBELL OUTDOOR	RWL1-48L-20-4K7-4W-UNV	SINGLE	2671	19.9	0.900

Eastern Wisconsin
 2625 S Greeley Street
 Milwaukee, WI 53207
 (P) 414-635-9900
 www.jthlighting.com



Calculated light levels shown are estimates based on information available at time of layout request. Due to unknown site conditions JTH Lighting assumes no responsibility for installed light levels.

Project #: 37574
 Date: 2/23/2022
 Paper Size: ARCH D - 24x36

RIDGEWOOD POOL
E1.0 - SITE LIGHTING PLAN

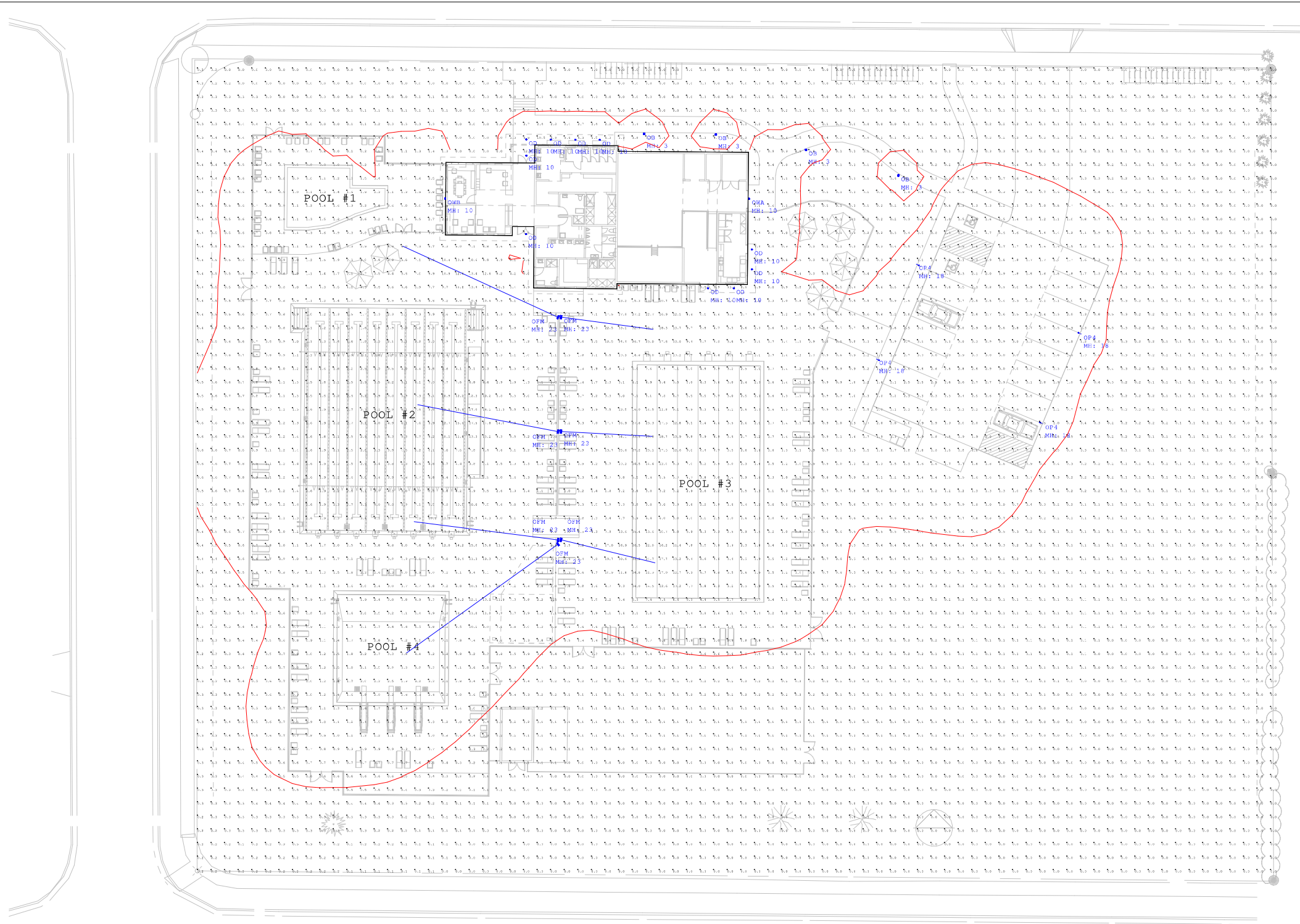

Scale: 1 inch= 20 Ft.

Calculation Summary

Label	CalcType	Units	Avg	Max	Min	Avg/Min	Max/Min
SITE	Illuminance	Fc	1.56	34.1	0.0	N.A.	N.A.
PARKING	Illuminance	Fc	2.27	3.2	0.9	2.52	3.56
POOL #1	Illuminance	Fc	1.57	3.6	0.9	1.74	4.00
POOL #2	Illuminance	Fc	4.60	18.0	0.9	5.11	20.00
POOL #3	Illuminance	Fc	6.16	25.8	1.2	5.13	21.50
POOL #4	Illuminance	Fc	3.53	8.8	1.5	2.35	5.87

Luminaire Schedule

Symbol	Qty	Label	Manufacturer	Description	Arrangement	Lum. Lumens	Lum. Watts	LLF
⊙	4	OB	HUBBELL OUTDOOR	FN2-12LU-4K	SINGLE	941	26.9	0.900
⊙	10	OD	PRESCOLITE	LFR-4RD-M-10L40K8XW-DM1_LFR-4RD-T-CL-SS	SINGLE	903	7.6	0.900
□	7	OFM	HUBBELL OUTDOOR	RFL5-360L-265-4K7-M	SINGLE	28983	252	0.900
—□	4	OP4	HUBBELL OUTDOOR	RAR1-80L-39-4K7-4W-UNV	SINGLE	5210	37.98	0.900
□	1	OWA	HUBBELL OUTDOOR	RWL1-48L-10-4K7-3-UNV	SINGLE	1355	10.1	0.900
□	1	OWB	HUBBELL OUTDOOR	RWL1-48L-20-4K7-4W-UNV	SINGLE	2671	19.9	0.900

1. Lighting Reflectance of 80/50/20 used unless noted otherwise
2. Interior calc points shown at 30" A.F.F. unless noted otherwise
3. Exterior calc points shown at grade unless noted otherwise
4. Emergency egress calc points shown at 0" A.F.F.
5. Photometric drawings are for Design purposes only, not for Construction documents

RIDGEWOOD POOL

E2.0 - PHOTOMETRIC PLAN

Project #: 37574
Date: 2/23/2022

Paper Size: ARCH D - 24x36

Calculated light levels shown are estimates based on information available at time of layout request. Due to unknown site conditions JTH Lighting assumes no responsibility for installed light levels.



Eastern Wisconsin
2625 S Greeley Street
Milwaukee, WI 53207
(p) 414-635-9900
www.jthlighting.com