

CREATE THE VISION TELL THE STORY

MADISON | MILWAUKEE
KENOSHA | APPLETON | WAUSAU

MADISON REGIONAL OFFICE
161 HORIZON DRIVE, SUITE 101
VERONA, WISCONSIN 53593
P. 608.848.5060

CLIENT:
**JEFF & JENNIFER
MADSON**

CLIENT ADDRESS:
**714 ONIEDA PLACE
MADISON, WI 53711**

DIGGERS HOTLINE

Toll Free (800) 242-8511

PROJECT:
2512 WAUNONA WAY

PROJECT LOCATION:
**CITY OF MADISON, WI
DANE COUNTY**

PLAN MODIFICATIONS:

#	Date:	Description:
1		
2		
3		
4		
5		
6		
7		
8		
9		
10		
11		
12		
13		
14		
15		

Design/Drawn: CJO 11-07-17
Approved: TJB 11-09-17

SHEET TITLE:

**EXISTING
CONDITIONS
SURVEY**

MAP NO: C-436

SHEET NUMBER:

1 OF 1

JSD PROJECT NO:

17-8243

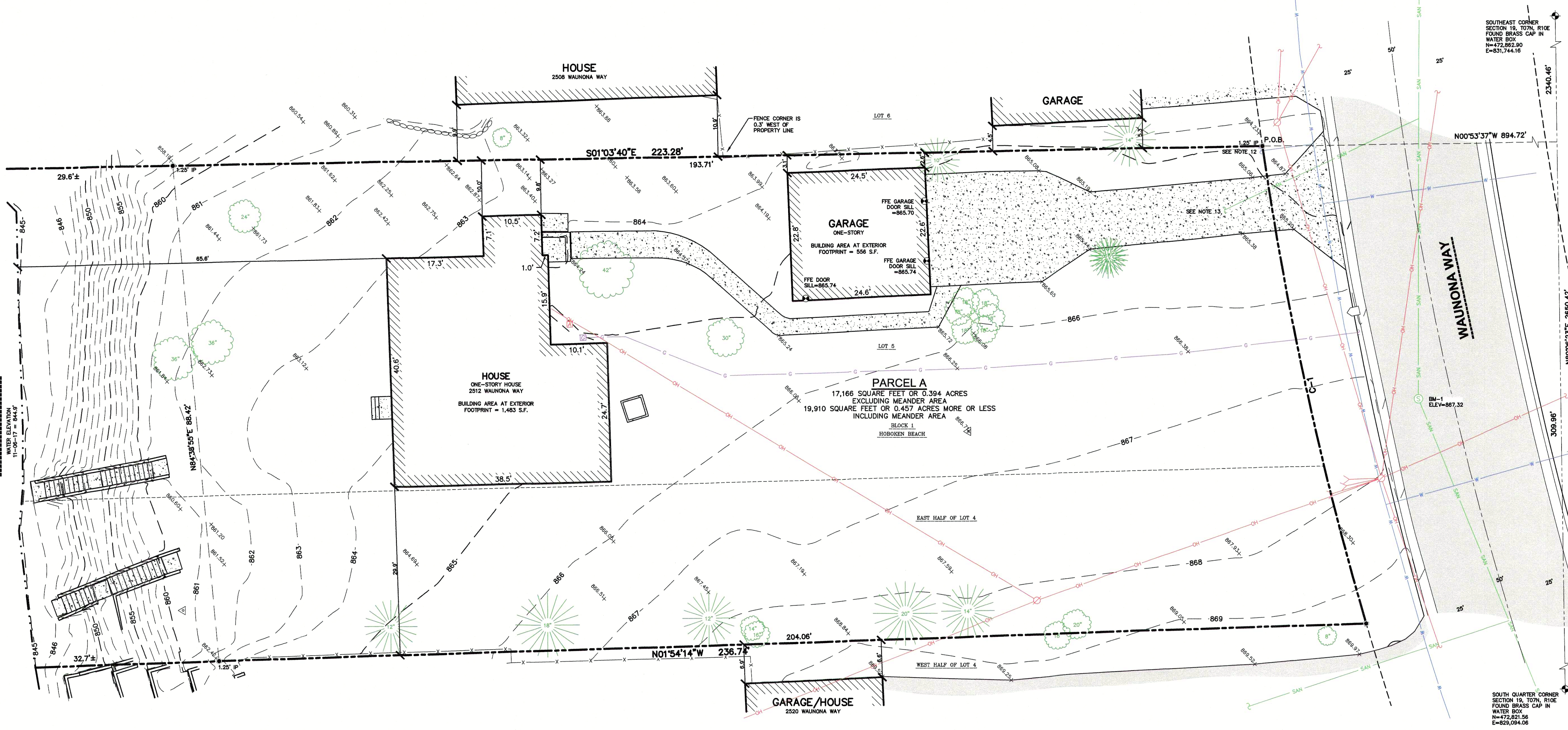

LAKE MONONA
WATER ELEVATION
11-08-17 = 844.17

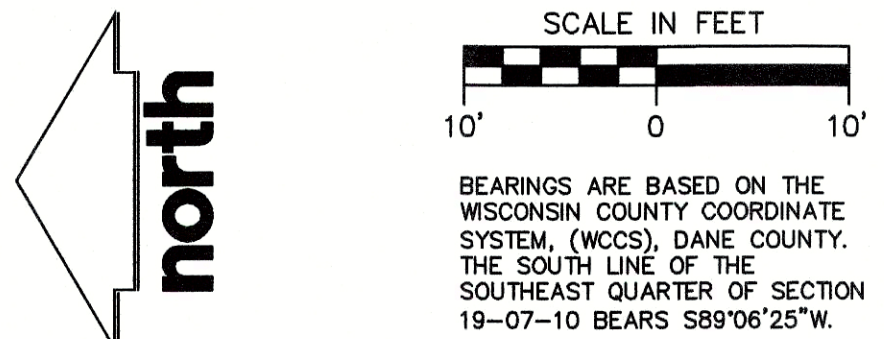

BEARINGS ARE BASED ON THE WISCONSIN COUNTY COORDINATE SYSTEM (WCCS), DANE COUNTY. THE SOUTH LINE OF THE SOUTHEAST QUARTER OF SECTION 19-07-10 BEARS S89°06'25"W.



VICINITY MAP
NOT TO SCALE

- LEGEND**
- GOVERNMENT CORNER
 - 1" IRON PIPE FOUND
 - IRON PIPE FOUND (SIZE NOTED)
 - PK/MAG NAIL FOUND
 - FINISHED FLOOR SHOT LOCATION
 - MAIL BOX
 - GAS REGULATOR/METER
 - AIR CONDITION UNIT
 - POWER POLE W/GUY
 - DECIDUOUS TREE
 - CONIFEROUS TREE
 - CHORD LINE
 - CENTERLINE
 - RIGHT-OF-WAY LINE
 - SECTION LINE
 - PARCEL BOUNDARY
 - PROPERTY LINE
 - EASEMENT LINE
 - x-x- FENCE LINE
 - STONE WALL
 - EDGE OF PAVEMENT
 - CONCRETE CURB & GUTTER
 - SANITARY SEWER
 - WATER LINE
 - NATURAL GAS
 - OVERHEAD LINE
 - WALL LINE
 - INDEX CONTOUR
 - INTERMEDIATE CONTOUR
 - EDGE OF WATER
 - SPOT ELEVATION
 - BITUMINOUS PAVEMENT
 - CONCRETE PAVEMENT
 - BUILDING
 - EDGE OF BITUMINOUS

NOTES

- FIELD WORK PERFORMED BY JSD PROFESSIONAL SERVICES, INC. ON NOVEMBER 06, 2017.
- BEARINGS FOR THIS SURVEY AND MAP ARE REFERENCED TO THE WISCONSIN COUNTY COORDINATE SYSTEM (WCCS), DANE COUNTY ZONE.
- ELEVATIONS ARE BASED ON THE NORTH AMERICAN VERTICAL DATUM OF 1988 (NAVD88). BENCHMARK IS A SANITARY SEWER MANHOLE SOUTH OF THE SITE = 867.32.
- CONTOUR INTERVAL IS ONE FOOT.
- SPOT ELEVATIONS IN CURBED AREAS REFERENCE THE PAVEMENT EDGE ELEVATIONS.
- SUBSURFACE UTILITIES AND FEATURES SHOWN ON THIS MAP HAVE BEEN APPROXIMATED BY LOCATING SURFICIAL FEATURES AND APPURTENANCES, LOCATING DIGGERS HOTLINE FIELD MARKINGS AND BY REFERENCE TO UTILITY RECORDS AND MAPS. DIGGERS' HOTLINE TICKET NO. 20174408446, WITH A CLEAR DATE OF NOVEMBER 06, 2017.
- UTILITY COMPANIES CONTACTED THRU DIGGERS HOTLINE:
CITY OF MADISON ENGINEERING
MGE (ELECTRIC AND GAS)
AT&T
- BEFORE EXCAVATION, APPROPRIATE UTILITY COMPANIES SHOULD BE CONTACTED. FOR EXACT LOCATION OF UNDERGROUND UTILITIES, CONTACT DIGGERS HOTLINE, AT 1.800.242.8511.
- JSD PROFESSIONAL SERVICES, INC. DOES NOT GUARANTEE THAT THE BENCHMARK ELEVATIONS LISTED ON THIS MAP HAVE NOT BEEN DISTURBED SINCE THE DATE OF THIS SURVEY AND SHOULD BE VERIFIED PRIOR TO CONSTRUCTION ACTIVITIES.
- THIS PARCEL IS ZONED TRADITIONAL RESIDENTIAL PER THE CITY OF MADISON ONLINE ZONING MAP, COPYRIGHT 2017.
- THIS PARCEL IS SUBJECT TO ALL EASEMENTS AND AGREEMENTS, BOTH RECORDED AND UNRECORDED. NONE SUPPLIED.
- WATER MAIN LATERAL NOT MARKED BY DIGGERS HOTLINE ON PRIVATE PROPERTY.
- SANITARY SEWER LATERAL NOT MARKED BY DIGGERS HOTLINE ON PRIVATE PROPERTY.

CURVE TABLE

CURVE	LENGTH	RADIUS	TANGENT	DELTA	CHORD	CHORD BEARING
C-1	86.91'	620.00'	43.53	8°01'53"	86.84'	S77°41'04"W

LEGAL DESCRIPTION

EAST HALF OF LOT 4, ALL OF LOT 5, BLOCK 1, HOBOKEN BEACH, CITY OF MADISON, DANE COUNTY, WISCONSIN.
TAX KEY NO: 0710-194-0305-6

SURVEYOR'S CERTIFICATE





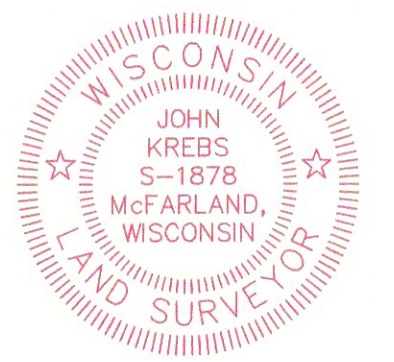

I, JOHN KREBS, WISCONSIN PROFESSIONAL LAND SURVEYOR NO. S-1878, HEREBY CERTIFY THAT THIS EXISTING CONDITIONS SURVEY AND MAP IS CORRECT TO THE BEST OF MY KNOWLEDGE AND BELIEF IN ACCORDANCE WITH THE INFORMATION PROVIDED.

John Krebs
JOHN KREBS, S-1878
PROFESSIONAL LAND SURVEYOR

11/9/17
DATE



LEGEND

-  PROPERTY LINE
-  BUILDING OUTLINE
-  EDGE OF PAVEMENT
-  STANDARD CURB AND GUTTER
-  CONCRETE PAVEMENT
-  RETAINING WALL
-  SILT FENCE

GENERAL NOTES

1. REFER TO THE EXISTING CONDITIONS SURVEY FOR EXISTING CONDITIONS NOTES AND LEGENDS.
2. ALL WORK IN THE ROW AND/OR PUBLIC EASEMENTS SHALL BE IN ACCORDANCE WITH THE CURRENT STANDARD SPECIFICATIONS OF MUNICIPALITY OR EASEMENT OWNER.
3. EXISTING GRADE SPOT ELEVATIONS SHOWN FOR INFORMATIONAL PURPOSES. DURING CONSTRUCTION MATCH EXISTING GRADES AT CONSTRUCTION LIMITS.
4. NO SITE GRADING OUTSIDE PROPERTY BOUNDARY OR DOWNSLOPE OF PROPOSED SILT FENCE LOCATION.
5. JSD SHALL BE HELD HARMLESS AND DOES NOT WARRANT ANY DEVIATIONS BY THE OWNER/CONTRACTOR FROM THE APPROVED CONSTRUCTION PLANS THAT MAY RESULT IN DISCIPLINARY ACTIONS BY ANY OR ALL REGULATORY AGENCIES.
6. REFER TO SHEET C1.1 FOR CONSTRUCTION SITE EROSION CONTROL, GRADING AND SEEDING AND UTILITY NOTES FOR FURTHER INFORMATION.

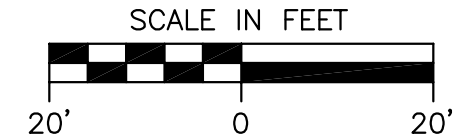
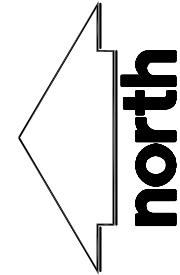

CREATE THE VISION TELL THE STORY

MADISON | MILWAUKEE
KENOSHA | APPLETON | WAUSAU

MADISON REGIONAL OFFICE
161 HORIZON DRIVE, SUITE 101
VERONA, WISCONSIN 53593
P. 608.848.5060

CLIENT:
**CLASSIC HOMES OF
MADISON, LLC.**

CLIENT ADDRESS:
659 RINPOCHE LANE
OREGON, WI 53575

PROJECT:
**MADSON LAKE HOUSE
2512 WAUNONA WAY
CITY OF MADISON**

PROJECT LOCATION:
MADISON, WI
DANE COUNTY

PLAN MODIFICATIONS:

#	Date	Description
1	12/7/2017	LAND USE SUBMITTAL
2		
3		
4		
5		
6		
7		
8		
9		
10		
11		
12		
13		
14		
15		

Design/Drawn: _____ (Initials)
Approved: _____ (Initials)

SHEET TITLE:
**GRADING &
UTILITY PLAN**

SHEET NUMBER:

C1.0

JSD PROJECT NO. _____ 17-8243

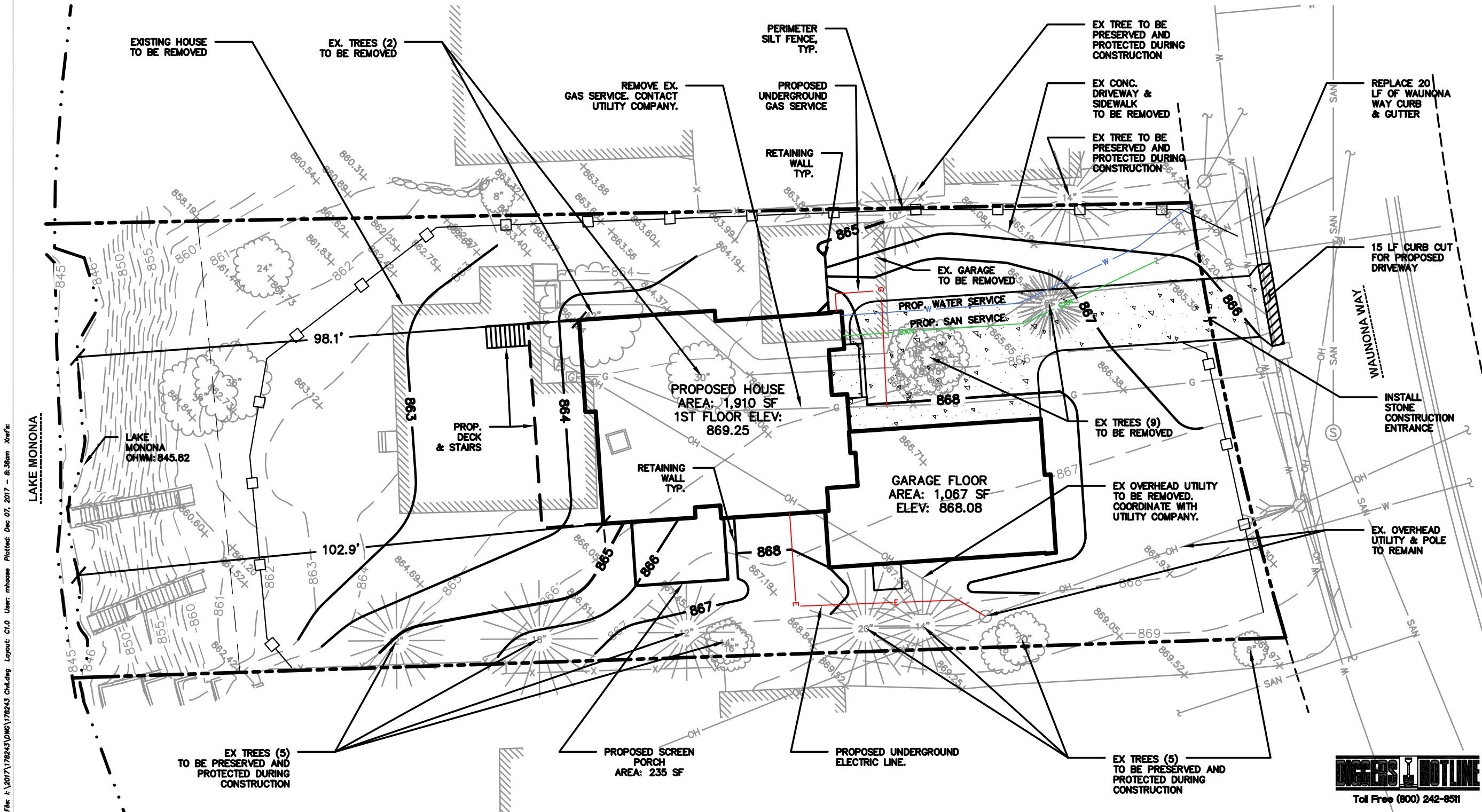

File: F:\2017\178243\DWG\178243_Civil.dwg Layout: C1.0 User: mhosee Plotted: Dec 07, 2017 - 8:36am Xref:



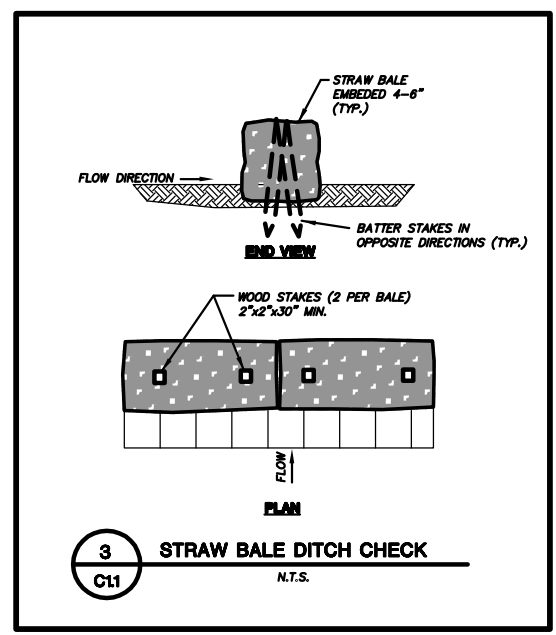
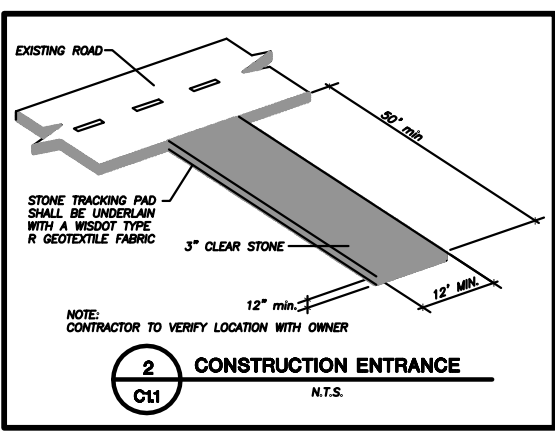
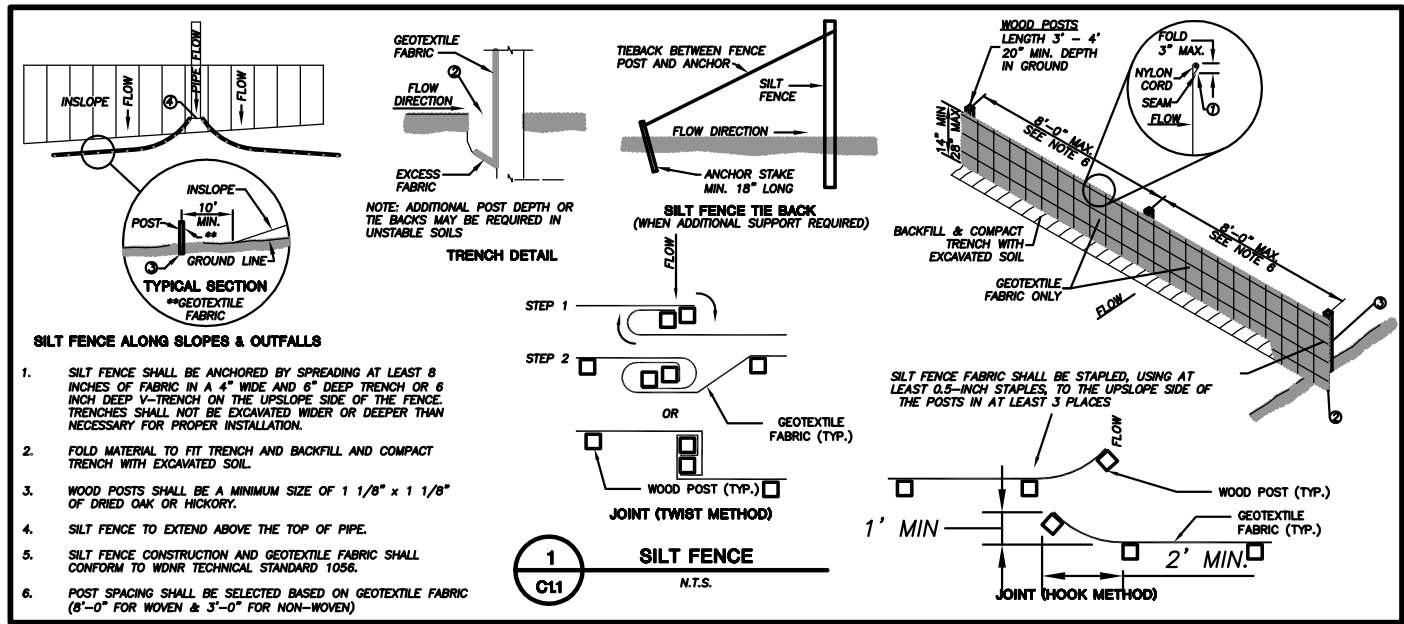

CONSTRUCTION SITE EROSION CONTROL NOTES

- ALL EROSION AND SEDIMENT CONTROL PRACTICES SHALL BE DESIGNED AND IMPLEMENTED IN ACCORDANCE WITH THE CURRENT DEPARTMENT OF NATURAL RESOURCES EROSION AND SEDIMENT CONTROL TECHNICAL STANDARDS WHICH ARE AVAILABLE AT: <http://www.dnr.state.wi.us/runoff/stormwater/techstds.htm>
- INSTALL EROSION CONTROL MEASURES PRIOR TO ANY SITE WORK, INCLUDING GRADING, DEMOLITION OR DISTURBANCE OF EXISTING SURFACE MATERIALS AS SHOWN ON PLAN. MODIFICATIONS TO EROSION CONTROL MEASURES MAY BE CONDUCTED TO MEET UNFORESEEN FIELD CONDITIONS.
- INSPECTIONS AND MAINTENANCE OF ALL EROSION CONTROL MEASURES SHALL BE ROUTINE (ONCE PER WEEK MINIMUM) TO ENSURE PROPER FUNCTION OF EROSION CONTROLS AT ALL TIMES. EROSION CONTROL MEASURES ARE TO BE IN WORKING ORDER AT THE END OF EACH WORK DAY.
- INSPECT EROSION CONTROL MEASURES AFTER EACH 1/2" OR GREATER RAINFALL. REPAIR ANY DAMAGE OBSERVED DURING THE INSPECTION.
- EROSION CONTROL MEASURES SHALL NOT BE REMOVED UNTIL ALL LAND DISTURBING CONSTRUCTION ACTIVITY AT THE SITE HAS BEEN COMPLETED AND THAT A UNIFORM PERENNIAL VEGETATIVE COVER HAS BEEN ESTABLISHED WITH A DENSITY OF AT LEAST 70% OF THE COVER FOR THE UNPAVED AREAS AND AREAS NOT COVERED BY PERMANENT STRUCTURES OR THAT EMPLOY EQUIVALENT PERMANENT STABILIZATION MEASURES.
- INSTALL EROSION CONTROLS ON THE DOWNSTREAM SIDE OF STOCKPILES.
- APPLY ANIONIC POLYMER TO DISTURBED AREAS IF EROSION BECOMES PROBLEMATIC.
- ADDITIONAL EROSION CONTROL MEASURES, AS REQUESTED BY STATE INSPECTORS, LOCAL INSPECTORS, AND/OR ENGINEER SHALL BE INSTALLED WITHIN 24 HOURS OF REQUEST.
- ALL SLOPES 4:1 OR GREATER SHALL BE STABILIZED WITH CLASS I, TYPE B EROSION MATTING AND DRAINAGE SWALES SHALL BE STABILIZED WITH CLASS II, TYPE B EROSION MATTING, WITHIN 7 DAYS OF REACHING FINAL GRADE AND/OR AS SOON AS CONDITIONS ALLOW. REFER BELOW TO "CSECR" NOTE NO. SIXTEEN (16) FOR STABILIZATION PRACTICES FOR POTENTIAL INTERIM STABILIZATION.

GRADING & SEEDING NOTES

- ALL PROPOSED GRADES SHOWN ARE FINISHED GRADES. CONTRACTOR SHALL VERIFY ALL GRADES, MAKE SURE ALL AREAS DRAIN PROPERLY AND SHALL REPORT ANY DISCREPANCIES TO THE ENGINEER PRIOR TO CONSTRUCTION.
- CONTRACTOR SHALL PROTECT ADJACENT PROPERTIES WITH SILT FENCING FOR EROSION CONTROL UNTIL CONSTRUCTION IS COMPLETED AND NOTICE OF TERMINATION FILED.
- CONTRACTOR SHALL WATER ALL NEWLY SODDED/SEEDED AREAS DURING THE SUMMER MONTHS WHENEVER THERE IS A 7 DAY LAPSE WITH NO SIGNIFICANT RAINFALL.
- CONTRACTOR TO DEEP TILL ALL COMPACTED PVIOUS SURFACES PRIOR TO SODDING AND/OR SEEDING AND MULCHING.
- THE CONTRACTOR SHALL NOTIFY THE MUNICIPALITY TWO (2) WORKING DAYS IN ADVANCE OF ANY SOIL DISTURBING ACTIVITY.
- CONSTRUCTION PRACTICES SHALL BE SEQUENCED SUCH THAT EROSION FROM SITE IS MINIMIZE TO MAXIMUM EXTENT PRACTICABLE, PERIMETER EROSION CONTROL MEASURES SHALL BE INSTALLED AND MAINTAINED TO MAXIMUM EFFECTIVENESS AND PROBLEMATIC AREAS OF EROSION SHALL BE ADDRESSED IMMEDIATELY.
- ROOF DISCHARGE FROM THE DOWNSPOUTS AND OTHER STORM PIPE DISCHARGES SHALL BE DIVERTED TO ESTABLISHED LAWN AREAS USING A 4" PERFORATED PLASTIC DRAINTILE. PIPE SHALL BE ROUTED TO DISCHARGE CLEAR OF THE AREA OF CONSTRUCTION DISTURBANCE. DISCHARGE END OF PIPE SHALL BE TURNED GENTLY UP-SLOPE SO DISCHARGE BLENDS THROUGH PERFORATIONS AND MINIMIZES CONCENTRATED DISCHARGE. DISCHARGE SHALL BE STABILIZED WITH STAKE STRAW BALES.

UTILITY NOTES

- IF ANY ERRORS, DISCREPANCIES, OR OMISSIONS WITHIN THE PLAN BECOME APPARENT, IT SHALL BE BROUGHT TO THE ATTENTION OF THE ENGINEER PRIOR TO CONSTRUCTION SO THAT CLARIFICATION OR REDESIGN MAY OCCUR.
- THE CONTRACTOR SHALL INSTALL A PEDESTRIAN FENCE AROUND ALL EXCAVATIONS TO BE LEFT OPEN OVER NIGHT AS REQUIRED.
- PRIOR TO CONSTRUCTION, THE CONTRACTOR IS RESPONSIBLE FOR:
 - EXAMINING ALL SITE CONDITIONS RELATIVE TO THE CONDITIONS INDICATED ON THE ENGINEERING DRAWINGS. ANY DISCREPANCIES ARE TO BE REPORTED TO THE ENGINEER AND RESOLVED PRIOR TO THE START OF CONSTRUCTION.
 - OBTAINING ALL PERMITS INCLUDING PERMIT COSTS, TAP FEES, METER DEPOSITS, BONDS, AND ALL OTHER FEES REQUIRED FOR PROPOSED WORK TO OBTAIN OCCUPANCY.
 - VERIFYING UTILITY ELEVATIONS AND NOTIFYING ENGINEER OF ANY DISCREPANCY. NO WORK SHALL BE PERFORMED UNTIL THE DISCREPANCY IS RESOLVED.
 - NOTIFYING ALL UTILITIES PRIOR TO THE INSTALLATION OF ANY UNDERGROUND IMPROVEMENTS.
 - NOTIFYING THE DESIGN ENGINEER AND MUNICIPALITY 48 HOURS PRIOR TO THE START OF CONSTRUCTION TO ARRANGE FOR APPROPRIATE CONSTRUCTION OBSERVATION.
- ANY SANITARY SEWER, SANITARY SEWER SERVICES, WATER MAIN, WATER SERVICES, STORM SEWER, OR OTHER UTILITIES, WHICH ARE DAMAGED BY THE CONTRACTORS, SHALL BE REPAIRED TO THE OWNER'S SATISFACTION AT THE CONTRACTOR'S EXPENSE.
- CONTRACTOR IS RESPONSIBLE FOR SITE SAFETY DURING THE CONSTRUCTION OF IMPROVEMENTS.
- CONTRACTOR SHALL CONTACT THE MUNICIPALITY'S PUBLIC WORKS DEPARTMENT A MINIMUM OF 48 HOURS BEFORE CONNECTING TO PUBLIC UTILITIES. CONTRACTOR TO VERIFY SIZE AND DEPTH OF EXISTING UTILITY SERVICES AND REPORT ANY DISCREPANCIES TO THE ENGINEER PRIOR TO CONNECTING.
- ALL PRIVATE SANITARY BUILDING PIPE AND TUBING SHALL CONFORM TO SPS 384.30-2.
- ALL PRIVATE STORM BUILDING PIPE AND TUBING SHALL CONFORM TO SPS 384.30-3.
- ALL PRIVATE PIPE AND TUBING FOR WATER SERVICE SHALL CONFORM TO SPS 384.30-4.
- ALL PRIVATE STORM PIPE SHALL CONFORM TO SPS 382.40(8)(B)4.A.
- ALL PRIVATE PIPE SHALL BE INSTALLED PER SPS 382.40-8.
- CONTRACTOR SHALL CONTACT ALL APPROPRIATE UTILITY COMPANIES FOR ANY REMOVAL, REPLACEMENT OR REROUTING OF ANY EXISTING UTILITIES ON-SITE.
- ABANDONMENT AND / OR REMOVAL OF ANY UTILITIES SHALL BE PER CURRENT LOCAL, STATE, AND FEDERAL REQUIREMENTS

SITE PLAN SUMMARY	
SITE ADDRESS	2512 WAUNONA WAY
PROPERTY AREA	17,186 SF (EXCLUDING MEANDER AREA)
	19,910± SF (INCLUDING MEANDER AREA)
PROPERTY ZONING DISTRICT	TR-C1
USE OF PROPERTY	SINGLE-FAMILY RESIDENTIAL
NUMBER OF BUILDING STORIES	2
PROPOSED HOUSE SQUARE FOOTAGE	1,910 SF
PROPOSED GARAGE SQUARE FOOTAGE	1,067 SF
PROPOSED SCREEN PORCH SQUARE FOOTAGE	235 SF
PROPOSED DRIVEWAY AREA	1,358 SF
PROPOSED LOT COVERAGE AREA	4,570 SF
PROPOSED LOT COVERAGE RATIO	26.6%
DEMOLITION STRUCTURES	
EXISTING BUILDING AREA	2,050 SF
EXISTING DRIVEWAY/PAVEMENT AREA	1,150 SF



CREATE THE VISION TELL THE STORY

MADISON | MILWAUKEE
KENOSHA | APPLETON | WAUSAU

MADISON REGIONAL OFFICE
161 HORIZON DRIVE, SUITE 101
VERONA, WISCONSIN 53593
P. 608.848.5060

CLIENT:
CLASSIC HOMES OF MADISON, LLC.

CLIENT ADDRESS:
659 RINPOCHE LANE
OREGON, WI 53575

PROJECT:
MADSON LAKE HOUSE
2512 WAUNONA WAY
CITY OF MADISON

PROJECT LOCATION:
MADISON, WI
DANE COUNTY

PLAN MODIFICATIONS:		
#	Date:	Description:
1	12/7/2017	LAND USE SUBMITTAL
2		
3		
4		
5		
6		
7		
8		
9		
10		
11		
12		
13		
14		
15		

Design/Drawn: (Initials)
Approved: (Initials)

SHEET TITLE:
PLAN NOTES & DETAILS

SHEET NUMBER:
C1.1



File: I:\2017\175243\DWG\175243 Basemap.dwg Layout: 22x34 (20 Scale) User: mhose Plotted: Dec 15, 2017 1:19pm Xref:

LAKEFRONT YARD SETBACK INFORMATION:

LAKE MONONA ORDINARY HIGH WATER MARK(OHWM) = 845.82 NGVD
 ADJACENT PROPERTIES:
 2520 WAUNONA WAY - MIN LAKEFRONT YARD SETBACK = 68.7 FEET
 2508 WAUNONA WAY - MIN LAKEFRONT YARD SETBACK = 72.3 FEET
 PROPOSED LAKEFRONT YARD SETBACK FOR 2512 WAUNONA WAY -
 AVG. OF TWO ADJOINING LOTS = 70.5 FEET

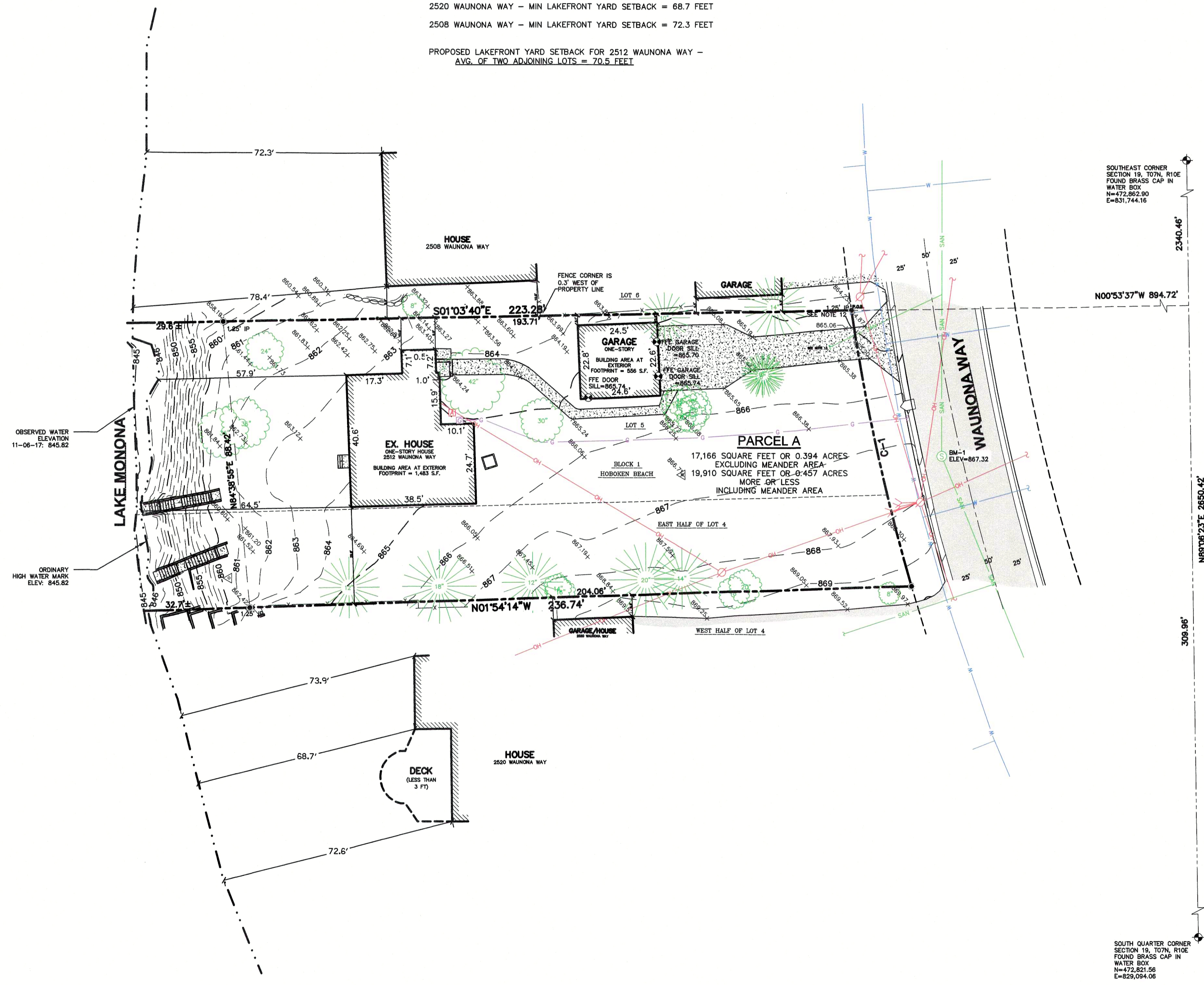

- LEGEND**
- GOVERNMENT CORNER
 - 1" IRON PIPE FOUND
 - IRON PIPE FOUND (SIZE NOTED)
 - PK/MAG NAIL FOUND
 - FINISHED FLOOR SHOT LOCATION
 - MAIL BOX
 - GAS REGULATOR/METER
 - AIR CONDITION UNIT
 - POWER POLE W/GUY
 - DECIDUOUS TREE
 - CONIFEROUS TREE
 - CHORD LINE
 - CENTERLINE
 - RIGHT-OF-WAY LINE
 - SECTION LINE
 - PARCEL BOUNDARY
 - PROPERTY LINE
 - EASEMENT LINE
 - x-x-x- FENCE LINE
 - STONE WALL
 - ===== EDGE OF PAVEMENT
 - ===== CONCRETE CURB & GUTTER
 - SANITARY SEWER
 - WATER LINE
 - NATURAL GAS
 - OVERHEAD LINE
 - WALL LINE
 - INDEX CONTOUR
 - INTERMEDIATE CONTOUR
 - EDGE OF WATER
 - SPOT ELEVATION
 - ===== BITUMINOUS PAVEMENT
 - ===== CONCRETE PAVEMENT
 - ===== BUILDING
 - ===== EDGE OF BITUMINOUS

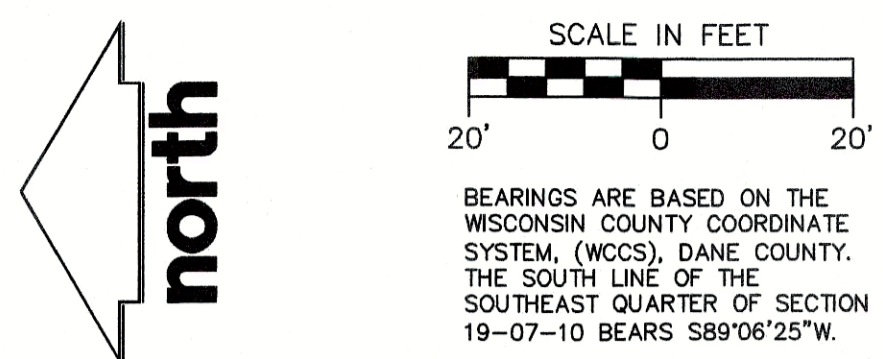

BEARINGS ARE BASED ON THE WISCONSIN COUNTY COORDINATE SYSTEM (WCCS), DANE COUNTY. THE SOUTH LINE OF THE SOUTHEAST QUARTER OF SECTION 19-07-10 BEARS S89°06'25"W.

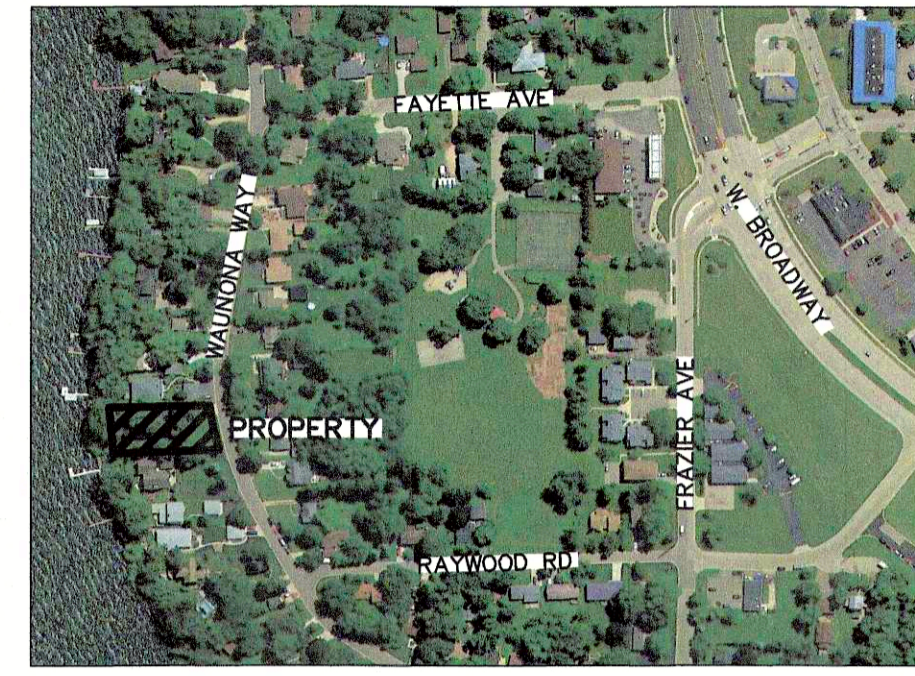

VICINITY MAP
NOT TO SCALE

NOTES

1. FIELD WORK PERFORMED BY JSD PROFESSIONAL SERVICES, INC. ON NOVEMBER 06, 2017.
2. BEARINGS FOR THIS SURVEY AND MAP ARE REFERENCED TO THE WISCONSIN COUNTY COORDINATE SYSTEM (WCCS), DANE COUNTY ZONE.
3. ELEVATIONS ARE BASED ON THE NORTH AMERICAN VERTICAL DATUM OF 1988 (NAVD88). BENCHMARK IS A SANITARY SEWER MANHOLE SOUTH OF THE SITE= 867.32.
4. CONTOUR INTERVAL IS ONE FOOT.
5. SPOT ELEVATIONS IN CURBED AREAS REFERENCE THE PAVEMENT EDGE ELEVATIONS.
6. SUBSURFACE UTILITIES AND FEATURES SHOWN ON THIS MAP HAVE BEEN APPROXIMATED BY LOCATING SURFICIAL FEATURES AND APPURTENANCES, LOCATING DIGGERS HOTLINE FIELD MARKINGS AND BY REFERENCE TO UTILITY RECORDS AND MAPS. DIGGER'S HOTLINE TICKET NO. 20174408446, WITH A CLEAR DATE OF NOVEMBER 06, 2017.
7. UTILITY COMPANIES CONTACTED THRU DIGGERS HOTLINE: CITY OF MADISON ENGINEERING MGE (ELECTRIC AND GAS) AT&T
8. BEFORE EXCAVATION, APPROPRIATE UTILITY COMPANIES SHOULD BE CONTACTED. FOR EXACT LOCATION OF UNDERGROUND UTILITIES, CONTACT DIGGERS HOTLINE, AT 1.800.242.8511.
9. JSD PROFESSIONAL SERVICES, INC. DOES NOT GUARANTEE THAT THE BENCHMARK ELEVATIONS LISTED ON THIS MAP HAVE NOT BEEN DISTURBED SINCE THE DATE OF THIS SURVEY AND SHOULD BE VERIFIED PRIOR TO CONSTRUCTION ACTIVITIES.
10. THIS PARCEL IS ZONED TRADITIONAL RESIDENTIAL PER THE CITY OF MADISON ONLINE ZONING MAP, COPYRIGHT 2017.
11. THIS PARCEL IS SUBJECT TO ALL EASEMENTS AND AGREEMENTS, BOTH RECORDED AND UNRECORDED. NONE SUPPLIED.
12. WATER MAIN LATERAL NOT MARKED BY DIGGERS HOTLINE ON PRIVATE PROPERTY.
13. SANITARY SEWER LATERAL NOT MARKED BY DIGGERS HOTLINE ON PRIVATE PROPERTY.

CURVE TABLE						
CURVE	LENGTH	RADIUS	TANGENT	DELTA	CHORD	CHORD BEARING
C-1	86.91'	620.00'	43.53	8°01'53"	86.84'	S77°41'04"W

LEGAL DESCRIPTION

EAST HALF OF LOT 4, ALL OF LOT 5, BLOCK 1, HOBOKEN BEACH, CITY OF MADISON, DANE COUNTY, WISCONSIN.
 TAX KEY NO: 0710-194-0305-6

SURVEYOR'S CERTIFICATE

I, JOHN KREBS, WISCONSIN PROFESSIONAL LAND SURVEYOR NO. S-1878, HEREBY CERTIFY THAT THIS EXISTING CONDITIONS SURVEY AND MAP IS CORRECT TO THE BEST OF MY KNOWLEDGE AND BELIEF IN ACCORDANCE WITH THE INFORMATION PROVIDED.

John Krebs
 JOHN KREBS, S-1878
 PROFESSIONAL LAND SURVEYOR

12/15/17
 DATE



CREATE THE VISION TELL THE STORY

MADISON | MILWAUKEE
 KENOSHA | APPLETON | WAUSAU

MADISON REGIONAL OFFICE
 161 HORIZON DRIVE, SUITE 101
 VERONA, WISCONSIN 53593
 P. 608.848.5060

CLIENT:
JEFF & JENNIFER MADSON

CLIENT ADDRESS:
**714 ONIEDA PLACE
 MADISON, WI 53711**

DIGGERS HOTLINE
 Toll Free (800) 242-8511

PROJECT:
2512 WAUNONA WAY

PROJECT LOCATION:
**CITY OF MADISON, WI
 DANE COUNTY**

PLAN MODIFICATIONS:

#	Date:	Description:
1		
2		
3		
4		
5		
6		
7		
8		
9		
10		
11		
12		
13		
14		
15		

Design/Drawn: CJO 11-07-17
 Approved: TJB 11-09-17

SHEET TITLE:
EXISTING CONDITIONS SURVEY

MAP NO: C-436
 SHEET NUMBER:

THESE PLANS AND DESIGNS ARE COPYRIGHT PROTECTED AND MAY NOT BE USED IN WHOLE OR IN PART WITHOUT THE WRITTEN CONSENT OF JSD PROFESSIONAL SERVICES, INC.

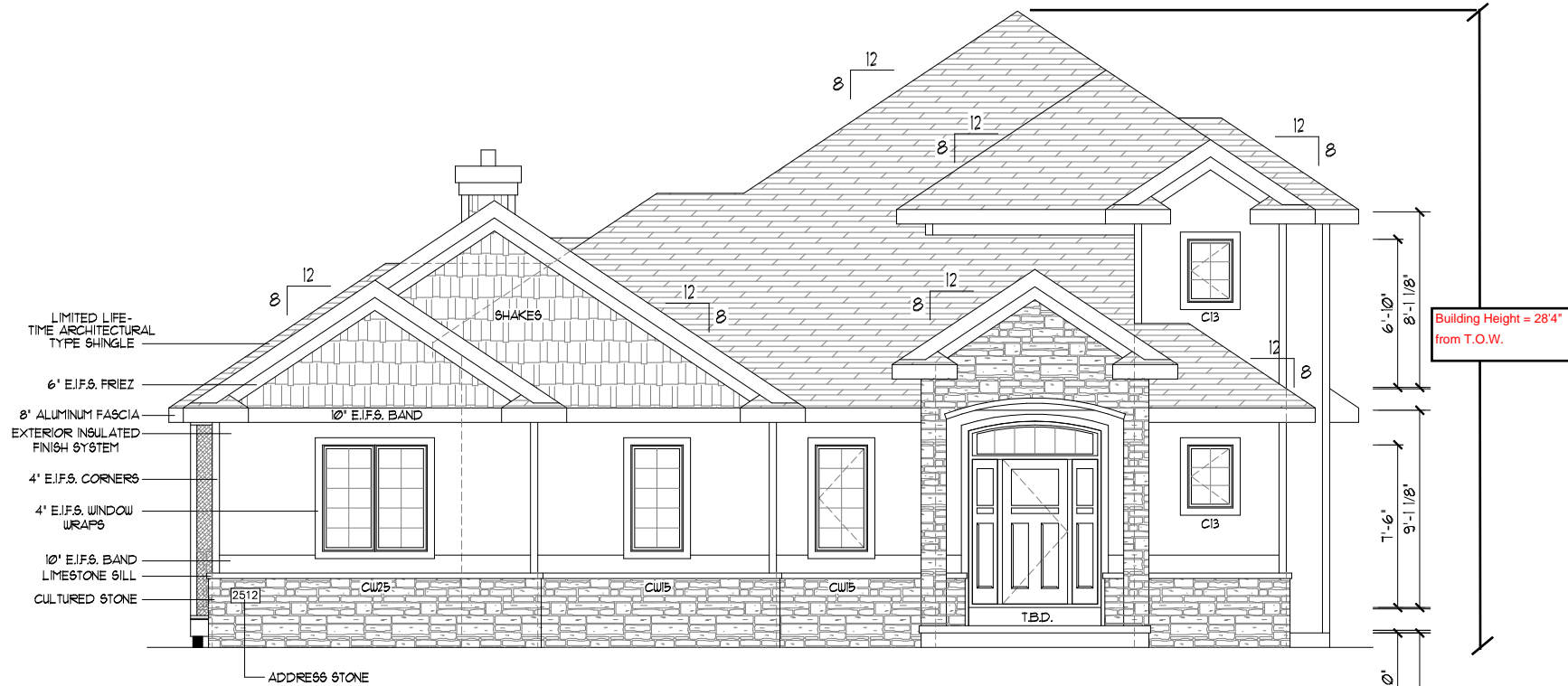

- LIMITED LIFE-TIME ARCHITECTURAL TYPE SHINGLE
- 6" E.J.F.S. FRIEZ
- 8" ALUMINUM FASCIA
- EXTERIOR INSULATED FINISH SYSTEM
- 4" E.J.F.S. CORNERS
- 4" E.J.F.S. WINDOW WRAPS
- 10" E.J.F.S. BAND
- LIMESTONE SILL
- CULTURED STONE

Building Height = 28'4"
from T.O.W.

FRONT ELEVATION

SCALE: 1/8" = 1'0"

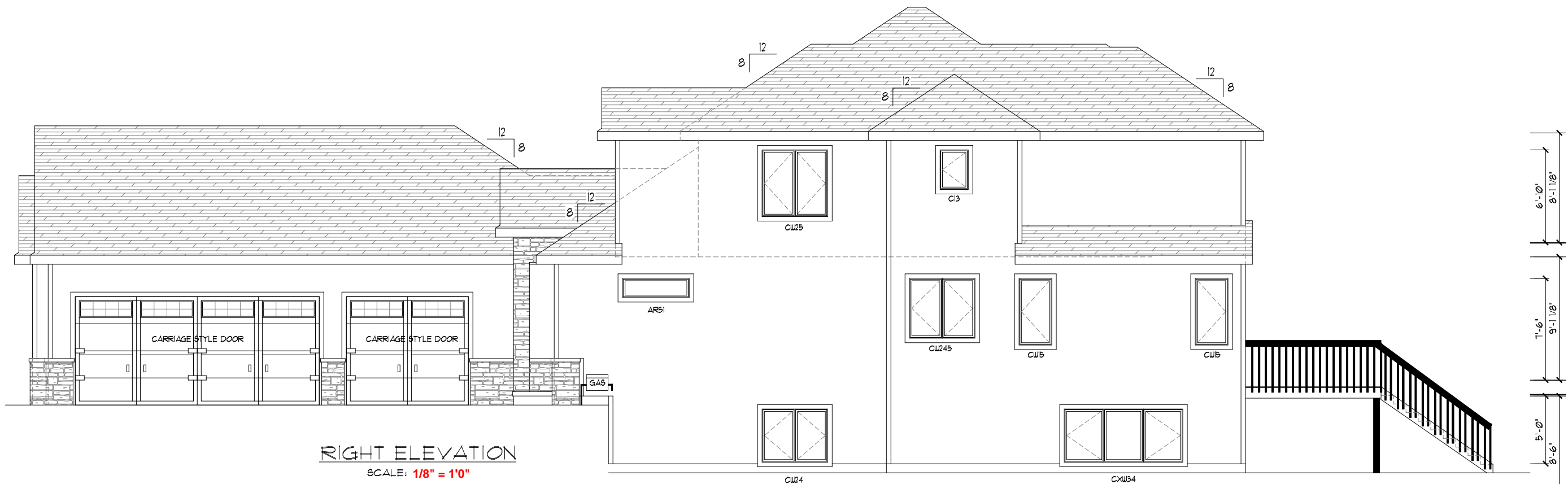

RIGHT ELEVATION

SCALE: 1/8" = 1'0"

CLASSIC HOMES OF MADISON
 PHONE: (608) 206-0492
 FAX: (608) 268-8665
 schmidt@ccharter.net

PLANS PREPARED BY:
DESIGN CONCEPTS
 CUSTOM RESIDENTIAL DESIGN
 & DRAFTING SERVICES
 2411 TAWHUR DR. #108
 FITCHBURG, WI 53711
 © 2017 DESIGN CONCEPTS

ORIGINAL PLANS: 10/13/17
 REVISIONS: 11/08/17, 11/10/17
 11/14/17, 11/17/17, 11/22/17
 11/28/17, 11/29/17, 12/01/17

MADISON LAKE HOUSE
 2512 WAUNONA WAY
 CITY OF MADISON
 DANE COUNTY, WI

Building Height = 33'4"
from Exposure T.O.W



REAR ELEVATION
SCALE: 1/8" = 1'0"

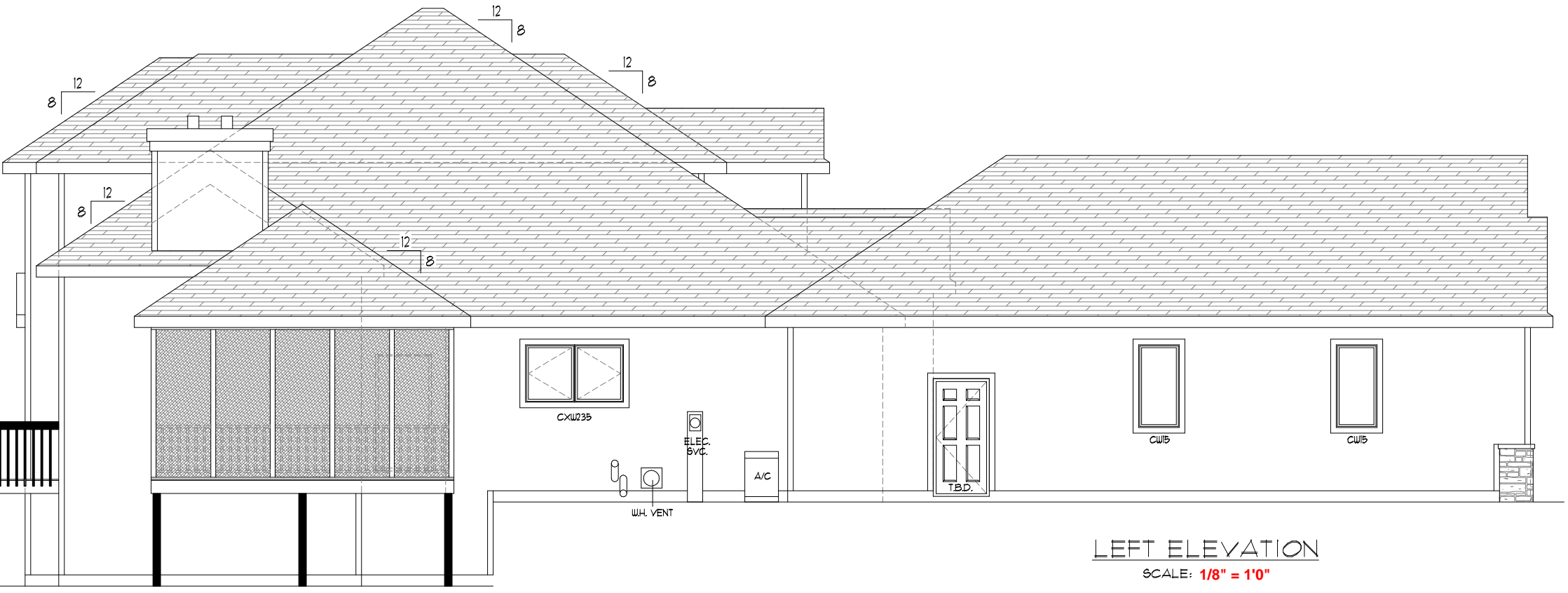
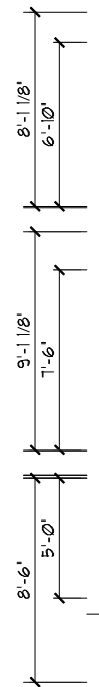

LEFT ELEVATION
SCALE: 1/8" = 1'0"

CLASSIC HOMES OF MADISON
PHONE: (608) 206-0492
FAX: (608) 268-8665
schmidt@charter.net

PLANS PREPARED BY:
DESIGN CONCEPTS
CUSTOM RESIDENTIAL DESIGN
& DRAFTING SERVICES
2411 TAWHEE DR. #108
FITCHBURG, WI 53711
© 2017 DESIGN CONCEPTS

ORIGINAL PLANS: 10/13/17
REVISIONS: 11/08/17, 11/10/17
11/14/17, 11/17/17, 11/22/17
11/28/17, 11/29/17, 12/01/17

MADISON LAKE HOUSE
2512 WAUNONA WAY
CITY OF MADISON
DANE COUNTY, WI

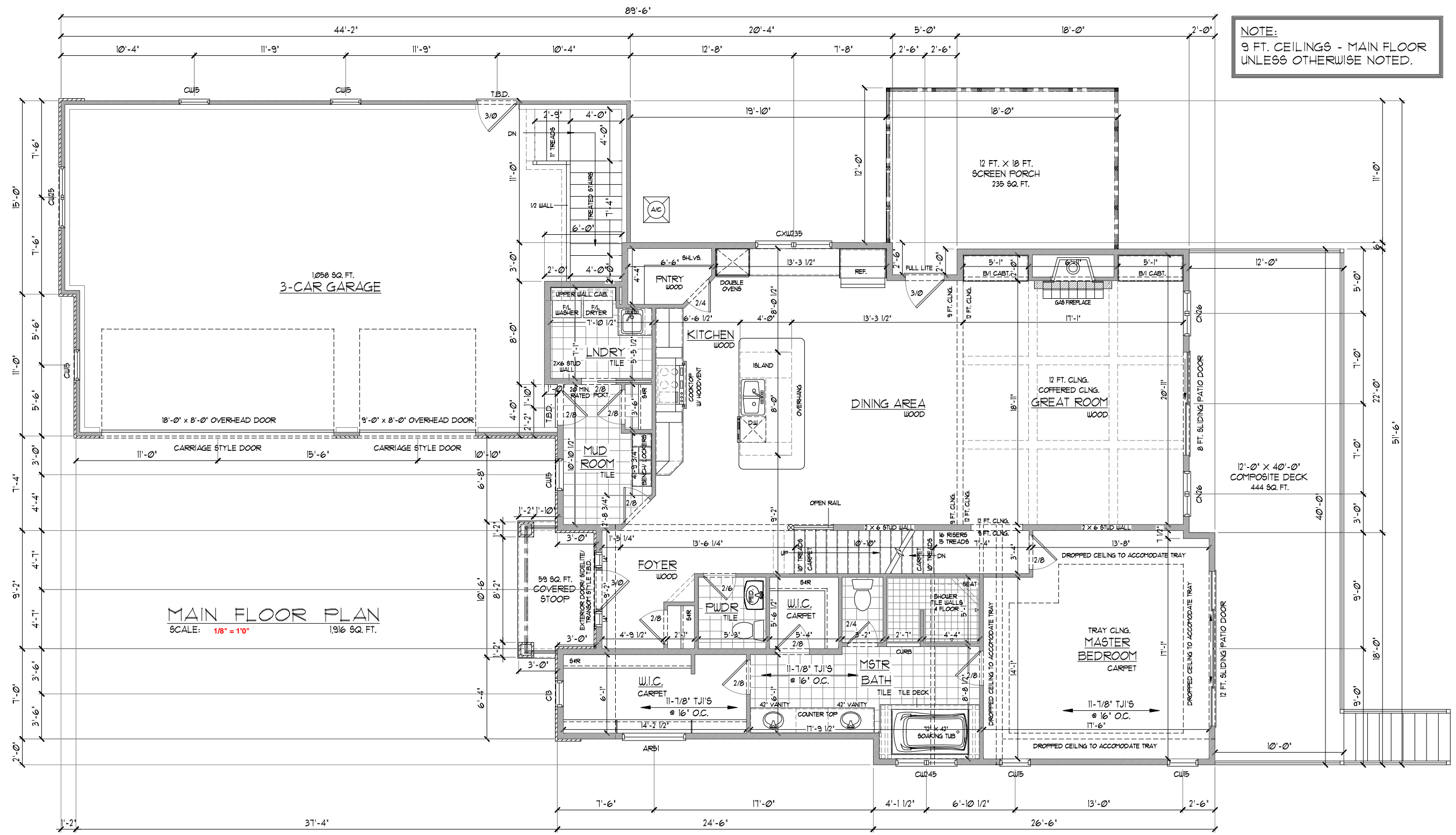

MAIN FLOOR PLAN
SCALE: 1/8" = 1'-0"

NOTE:
9 FT. CEILINGS - MAIN FLOOR
UNLESS OTHERWISE NOTED.

CLASSIC HOMES OF MADISON
PHONE: (608) 206-0492
FAX: (608) 268-8665
schmidtc@charter.net

PLANS PREPARED BY:
DESIGN CONCEPTS
CUSTOM RESIDENTIAL DESIGN
& DRAFTING SERVICES
2411 TAWHEE DR. #108
FITCHBURG, WI 53711
© 2017 DESIGN CONCEPTS

ORIGINAL PLANS: 10/13/17
REVISIONS: 11/08/17, 11/10/17
11/14/17, 11/17/17, 11/22/17
11/28/17, 11/29/17, 12/01/17

MADSON LAKE HOUSE
2512 WAUNONA WAY
CITY OF MADISON
DANE COUNTY, WI

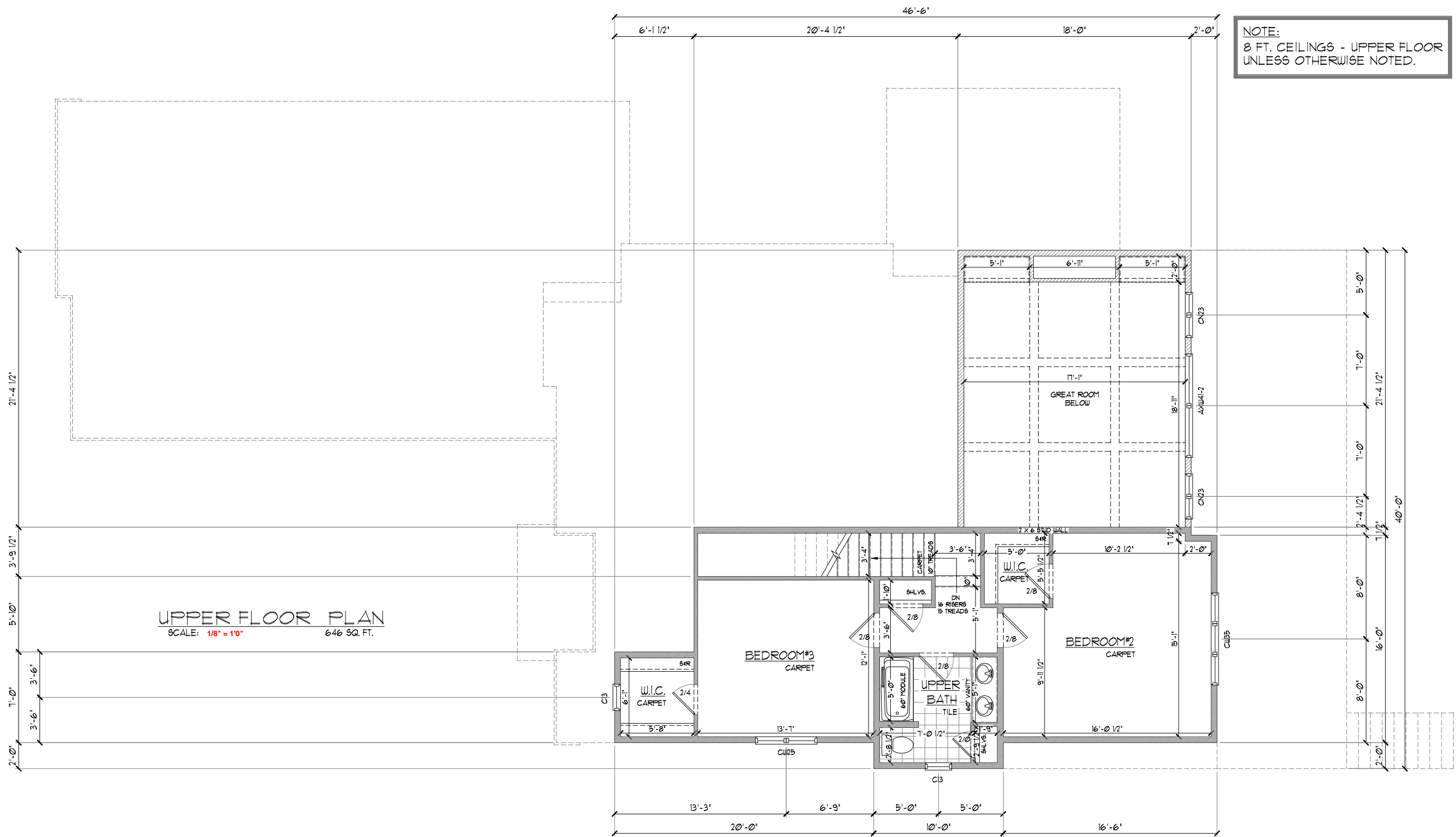

NOTE:
8 FT. CEILINGS - UPPER FLOOR
UNLESS OTHERWISE NOTED.

UPPER FLOOR PLAN
SCALE: 1/8" = 1'-0"
646 SQ. FT.

CLASSIC HOMES OF MADISON
PHONE: (608) 206-0492
FAX: (608) 268-8665
schmidt@ccharter.net

PLANS PREPARED BY:
DESIGN CONCEPTS
CUSTOM RESIDENTIAL DESIGN
& DRAFTING SERVICES
2411 TAWHUR DR. #108
FITCHBURG, WI 53711
© 2017 DESIGN CONCEPTS

ORIGINAL PLANS: 10/13/17
REVISIONS: 11/08/17, 11/10/17
11/14/17, 11/17/17, 11/22/17
11/28/17, 11/29/17, 12/01/17

MADISON LAKE HOUSE
2512 WAUNONA WAY
CITY OF MADISON
DANE COUNTY, WI

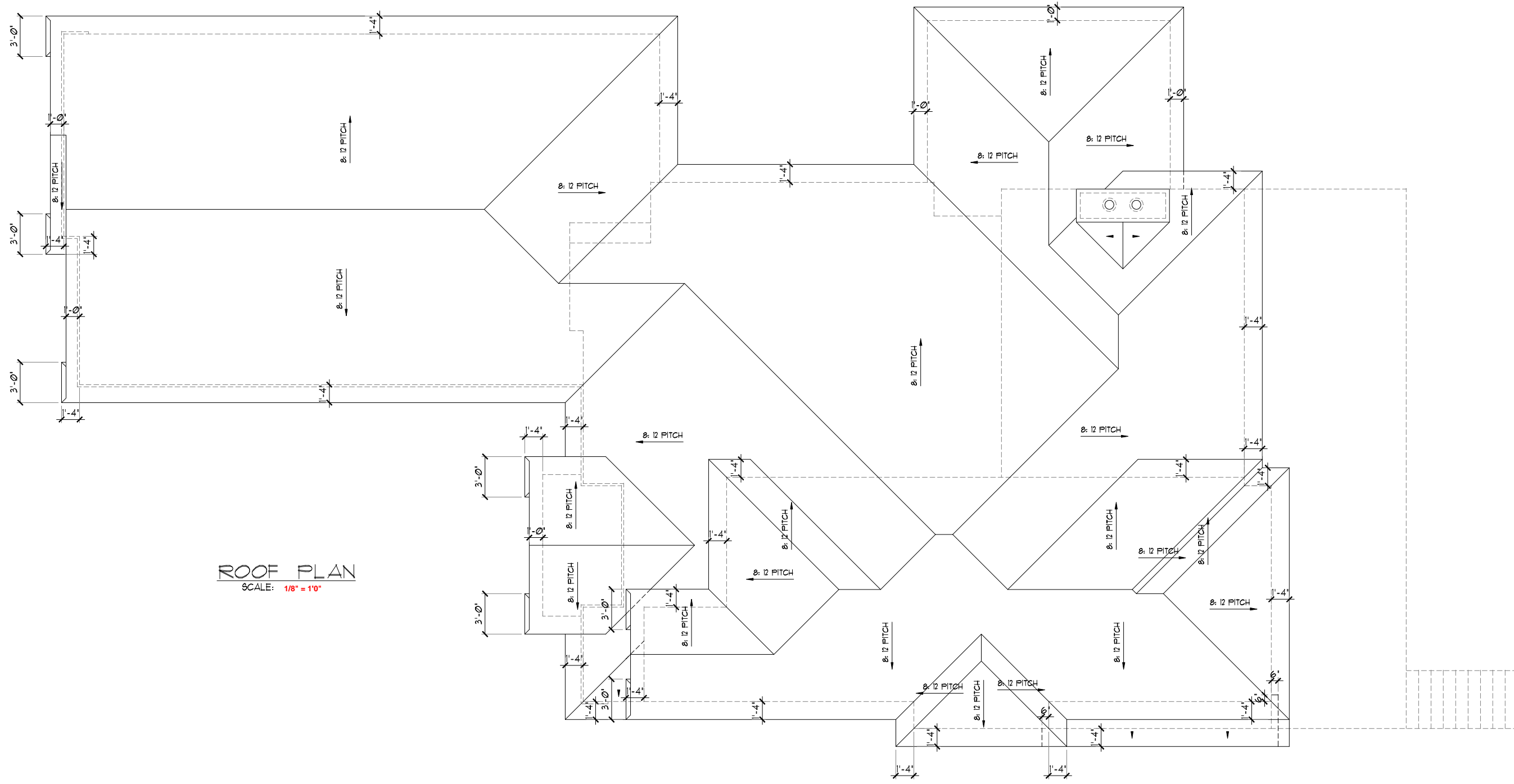

ROOF PLAN
SCALE: 1/8" = 1'-0"

MADSON LAKE HOUSE
2512 WAUNONA WAY
CITY OF MADISON
DANE COUNTY, WI

ORIGINAL PLANS: 10/13/17
REVISIONS: 11/08/17, 11/10/17
11/14/17, 11/17/17, 11/22/17
11/28/17, 11/29/17, 12/01/17

PLANS PREPARED BY:
DESIGN CONCEPTS
CUSTOM RESIDENTIAL DESIGN
& DRAFTING SERVICES
2411 TAWHEE DR. #108
FITCHBURG, WI 53711
© 2017 DESIGN CONCEPTS

CLASSIC HOMES OF MADISON
PHONE: (608) 206-0492
FAX: (608) 268-8665
schmidt@charter.net

ROOF SYSTEM

- ENGINEERED TRUSSES
 - 24' O.C.
 - 12' ENERGY HEEL
- SHEATHING
 - 1/2" ORIENTED STRAND BOARD (O.S.B.) SHEATHING
 - 15# FELT UNDERLAYMENT SHINGLES
 - LIMITED LIFETIME ARCHITECTURAL

OVERHANGS & RAKES

- ALUM. SOFFIT FASCIA
 - 8" ALUMINUM FASCIA
 - ALUMINUM VENTED SOFFIT PANELS

EXTERIOR WALLS

- STUDS SPACED 16" O.C.
 - 2X6 HOUSE
- SHEATHING
 - 7/16" O.S.B. SHEATHING
 - TYVEK HOUSEWRAP - HOUSE
- INSULATION
 - R-19 BATTS - HOUSE
 - POLY VAPOR BARRIER -HOUSE
- SIDING
 - EXTERIOR INSULATED FINISH SYSTEM (E.I.F.S.)
- 1/2" GYPSUM BOARD INTERIOR

FOUNDATION

- TREATED SILL PLATE
 - 2X6 HOUSE
- FOUNDATION WALLS
 - 8" Poured CONC.
 - 8'-9" TALL
- FOOTING
 - Poured 8" x 16"
- DAMP-PROOFING
 - SNAP & PARGE TIES
 - DRAIN TILE INTERIOR
 - DRAIN TILE EXTERIOR
 - 3" GRAVEL BASE
 - SUMP BASIN
 - ONE INCH MARFLEX 'SHOCKWAVE' DRAINAGE/ INSULATION BOARD SYSTEM (R-9 MIN.)
- 3' CONCRETE FLOOR

WEBS PER TRUSS DESIGN

CEILING

- VAPOR BARRIER TO WARM SIDE
- INSULATION
 - R-50 BLOWN W/ BAFFLES
- GYPSUM BOARD INTERIOR FINISH
 - 5/8" GYP.

INTERIOR WALLS

- STUDS SPACED 16" O.C.
 - 2X4
- 1/2" GYPSUM BOARD BOTH SIDES

FLOOR SYSTEMS

- INSULATE @ EXTERIOR ENDS
- JOISTS (CENTERS AS PER PLANS)
 - 11-7/8" TJI
- FLOOR SHEATHING (GLUE/ NAILED)
 - 3/4" TONGUE & GROOVE O.S.B.

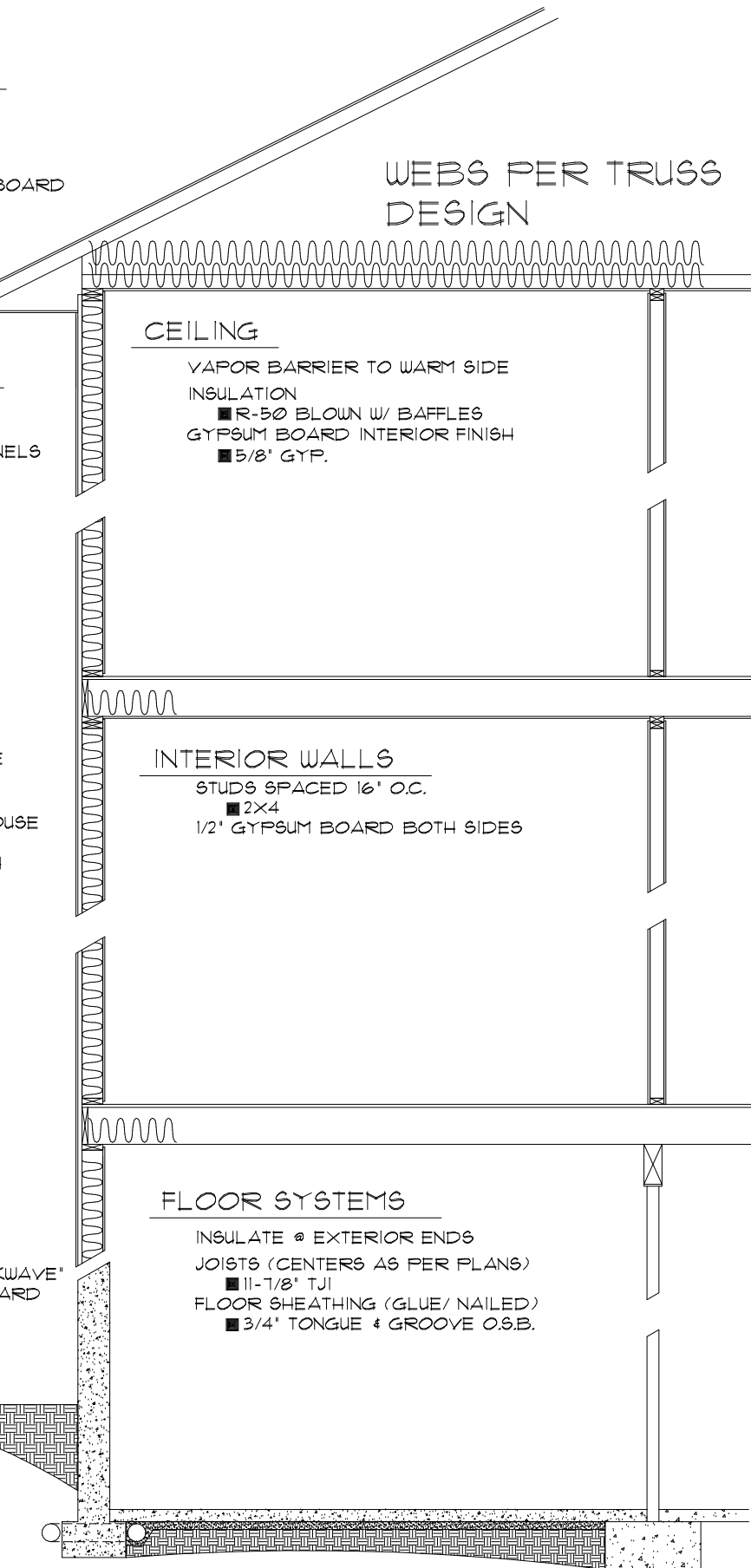

TYPICAL WALL SECTION
N.T.S.

CURVE DATA

CURVE	CHORD BEARING	CHORD LENGTH	RADIUS
C1	S 77°41'04" W	86.84'	620.00'

LAKE MONONA
WATER ELEVATION (11-06-17): 844.90'

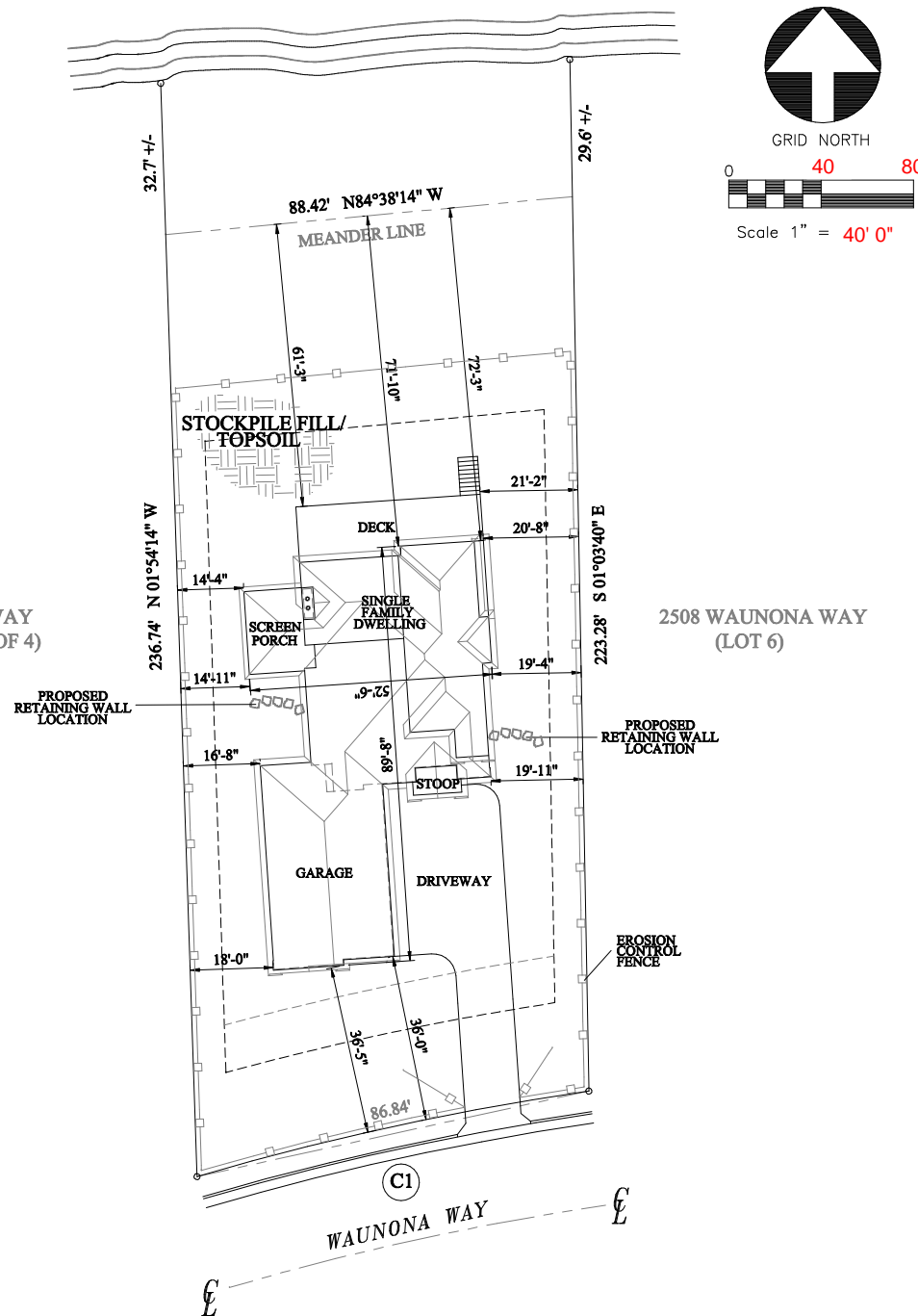

2520 WAUNONA WAY
(LOT 3 AND PART OF 4)

2508 WAUNONA WAY
(LOT 6)

2512 WAUNONA WAY
PART OF LOT 4 & ALL OF LOT 5
PLAT OF HOBOKEN BEACH
CITY OF MADISON, DANE COUNTY, WI
APPROXIMATELY 19,910 SQUARE FEET

CLASSIC HOMES OF MADISON
PHONE: (608) 206-0492
FAX: (608) 268-8665
schmidt@ccharter.net

PLANS PREPARED BY:
DESIGN CONCEPTS
CUSTOM RESIDENTIAL DESIGN
& DRAFTING SERVICES
2411 TAWHEE DR. #108
FITCHBURG, WI 53711
© 2017 DESIGN CONCEPTS

ORIGINAL PLANS: 10/13/17
REVISIONS: 11/08/17, 11/10/17
11/14/17, 11/17/17, 11/22/17
11/28/17, 11/29/17, 12/01/17

MADISON LAKE HOUSE
2512 WAUNONA WAY
CITY OF MADISON
DANE COUNTY, WI