



The Hub at Madison II - Conditional Use Application

Core Campus Developers | Antunovich Associates Architecture · Planning

Submitted March 4th 2015

Madison, Wisconsin | February 24, 2015

Table of Contents

PLANNING

Letter of Intent
Combined Submittal
Project Information
Project Name
Applicant
Design Team
Existing Conditions

List of Drawings

CIVIL

ALTA Survey
Civil Engineering
C-100 Existing Conditions Plan
C-200 Demolition Plan
C-300 Grading and Erosion Control Plan
C-400 Utility Plan
Fire Access Plan

ARCHITECTURAL

Context Plan
Roof Context Plan
Site Plan
Basement Parking Plan
Ground Floor Plan
Mezzanine Parking Plan
Second Floor Plan
Third Floor Plan
Typical Floor Plan (04-09)
Tenth Floor Plan
Eleventh Floor Plan
Twelfth Floor Plan
Roof/Pool Terrace Plan
Typical Unit Plans
Typical Townhome Unit Plans
Building Section

Project Area Summary

LANDSCAPING

Site Landscape Plan
Second Floor North Landscape plans
Second Floor South Landscape Plans
Third, Roof/Pool Terrace Landscape Plans/Plant List
Ornamental Tree Images
Shrub Images
Shrub Images
Perennial Images
Perennial Images
Perennial Images

MASSING SHADOW STUDIES

Massing/Height/Shadow Studies
Shadows Studies

ELEVATIONS

University Ave Elevation
Gorham Street Elevation
Gilman Street Elevation
North East Elevation
South West Elevation

RENDERED VIEWS

Aerial View 1
Aerial View 2
View East on University Ave
View North on Bassett Street
View West on Gorham Street
View South West of Gilman Street
View North East up Gilman Street
Gilman Street Existing Facade - Circa 1940's
Gilman Street Existing Facade - Today
Gilman Street Existing Facade - Today
Sidewalk View Gilman Street Existing facade
Sidewalk View University Ave Street
Sidewalk View Gorham Street Street

CONTEXT VIEWS

View North East from University Ave
View South West on Gorham Street
View South West on Gilman Street



Table of Contents

Letter of Intent 3
Conditional Use & Demolition Request..... 3
Project Information 3
 Project Name..... 3
 Applicant..... 3
 Design Team..... 3
Existing Conditions 4
Site Photos..... 4
Demolition Request 7
Conditional Use Request 10
Downtown Design Guidelines..... 12
Exhibit A: Legal Description 16
Project Plans **Error! Bookmark not defined.**



Letter of Intent

The following document outlines the Conditional Use and Demolition Request Submittal for "The Hub at Madison II", an exciting new mixed-use, residential development.

Total Building Square Footage: 445,027 gross square feet

Proposed Uses:

Retail: 8,740 square feet
Gilman Street Flex: 2,992 square feet
(Retail, Commercial or Residential)
Residential: 348 units
830 total beds

Parking:

Automobile:	Required:	0 stalls
	Supplied:	136 stalls (13 flex spaces)
Moped:	Required:	0 stalls
	Supplied:	up to 78 flex stalls
Bike:	Required:	508 stalls Residential Stalls (assumes all flex space as residential) 10 Retail Stalls (assumes all flex as retail)
	Supplied:	408 stalls in general parking area 200 stalls in units (credit of 100 bike parking stalls)

Loading: 1 off-street loading stall

Lot Coverage:

Green Roof 3,324 square feet (minimum)
University Avenue Open Area: 971 square feet

Conditional Use & Demolition Request

Zoning Map Amendment: Conditional Use (UMX)
Building in excess of 20,000 square feet
Reduction to one loading dock

Demolition Request: 435 West Gilman Street

Project Information

Project Name

The Hub at Madison II

Applicant

Core Campus, LLC.
2234 West North Avenue
Chicago, Illinois 60647
Phone: (773) 227-2850
Fax: (773) 227-5350
Marc Lifshin
Marc@CoreCamp.us

Design Team

Architects:
Antunovich Associates
224 West Huron Street
Chicago, Illinois 60654
Phone: (312) 266-1126
Fax: (312) 576-2594
Jeff Zelisko
jelisko@Antunovich.com

Landscape Architect:
Schaefer Land Design
405 N. Page Street
Stoughton, WI 5358
Phone: (608)225-7946
Jim Schaefer
jschaefer@sbcglobal.net

Planner:
Vandewalle & Associates
120 East Lakeside Street
Madison, WI 53715
Phone: (608)255.3988
Fax: (608)255-0814
Brian Munson
bmunson@vandewalle.com

Engineer:
Burse Engineering
1400 East Washington Avenue
Madison, WI 53703
Phone:
Fax:
Michelle Burse
mburse@bse-inc.net



Existing Conditions

Address/Existing Use 510 University Avenue 435 West Gilman	Surface Parking/Vacant First floor: Retail Second Floor: 8 Residential Apartments
Parcel Identification Numbers: 510 University Avenue	0709-232-0116-8
Aldermanic District:	District 4 Alder Mike Verveer
Neighborhood Association:	State Langdon Neighborhood Association
Alder/Neighborhood Notification:	December 1, 2014
Legal Description:	See Exhibit A
Lot Area:	.97 acres
Existing Zoning:	Urban Mixed Use
Downtown Plan:	State Street District Downtown Mixed Use
Comp. Plan Designation:	State Street District
Development Schedule:	Fall 2015 - Construction Start 14-18 Month Construction Period Target Opening: August 2017
Downtown Height Map:	12 Story Maximum
Downtown Stepback:	
University/Gorham:	15' stepback above 4 Floors
Gilman:	15' stepback above 4 Floors

Site Photos



Site Photos (Continued)



Site Photos (Continued)



Demolition Request

The building located at 435 West Gilman was originally built in 1929 as a automobile dealership/garage. This building was constructed as primarily a slab on grade simple concrete floor system with masonry sides and has been renovated numerous times to accommodate differing commercial uses. The exterior side and rear have been covered with stucco. Due to the utilitarian nature of the original use and subsequent repurposing no interior finishes remain. A small basement area is located at the rear 1/4 of the building which houses the first floor HVAC system and water heaters for the building.

The upper floors have been converted to eight apartment units that have undergone several renovations leaving them in an unadorned "white box" state. These units use electric baseboard heating and through wall air conditioners in the bedrooms.

The main building cannot be integrated into the project based upon the construction type, existing inefficiencies and project economics. The Gilman Street facade is being incorporated into the design of the building to preserve the character of the streetscape, with the balance of the building proposed for demolition.







Conditional Use Request

Per the Downtown Core Zoning District, buildings in excess of 20,000 square feet shall obtain conditional use approval and shall be reviewed against the Downtown Urban Design Guidelines.

The project is also requesting the following modifications per the conditional use request:

- 1.) Reduce the number of off-street loading stalls required for the building to one stall.
- 2.) Reduce number of bike parking stalls by 100 (200 in-unit bike parking stalls).

Conditional Use Standards:

1. *The establishment, maintenance or operation of the conditional use will not be detrimental to or endanger the public health, safety, or general welfare.*

The building is consistent with the height, stepback, and planned uses for this site.

2. *The City is able to provide municipal services to the property where the conditional use is proposed, given due consideration of the cost of providing those services.*

The site is currently fully served by municipal services

3. *The uses, values and enjoyment of other property in the neighborhood for purposes already established will not be substantially impaired or diminished in any foreseeable manner.*

The proposed uses are complimentary to the adjoining uses and the overall neighborhood.

4. *The establishment of the conditional use will not impede the normal and orderly development and improvement of the surrounding property for uses permitted in the district.*

The proposed conditional use will not impede any adjoining properties from developing.

5. *Adequate utilities, access roads, drainage, parking supply, internal circulation improvements, including but not limited to vehicular, pedestrian, bicycle, public transit and other necessary site improvements have been or are being provided.*

This parcel is well served by the full spectrum of transportation options including the preservation of the existing metro stop located next to the proposed lobby as well as accommodating the potential Bus Rapid Transit System and B-Cycle station. The building is designed to include on-site parking for bikes, mopeds, and cars in support of the proposed use.

6. *Measures, which may include transportation demand management (TDM) and participation in a transportation management association have been or will be taken to provide adequate ingress and egress, including all off-site improvements, so designed as to minimize traffic congestion and to ensure public safety and adequate traffic flow, both on-site and on the public streets.*

The project is being design to foster use of the rich transportation network and walkable location.

Automobile parking is being designed to the minimum market demand level to encourage residents to use alternative methods.

7. *The conditional use conforms to all applicable regulations of the district in which it is located.*

The proposed use is consistent with the Urban Mixed Use (UMX).

8. *When applying the above standards to an application by a community living arrangement, the Plan Commission shall: a. Bear in mind the City general intent to accommodate community living arrangements. b. Exercise care to avoid an over-concentration of community living arrangements, which could create an institutional setting and seriously strain the existing social structure of a community. Considerations relevant for this determination are the distance between the proposed facility and other such facilities, the capacity of the proposed facility and the by which the facility will increase the population of the community, the total capacity of all community living arrangements in the community, the impact on the community of other community living arrangements, the success or failure of integration into communities of other such facilities operated by the individual or group seeking approval, and the ability of the community to meet the special needs, if any, of the applicant facility.*

Not Applicable

9. *When applying the above standards to any new construction of a building or an addition to an existing building the Plan Commission: a. Shall bear in mind the statement of purpose for the zoning district, and b. May require the applicant to submit plans to the Urban Design Commission for comment and recommendation.*

The proposed use is consistent with the Urban Mixed Use (UMX).

10. *When applying the above standards to an application for a reduction in off-street parking requirements, the Plan Commission shall consider and give decisive weight to all relevant facts, including but not limited to, the availability and accessibility of alternative parking; impact on adjacent residential neighborhoods; existing or potential shared parking arrangements; number of residential parking permits issued for the area; proximity to transit routes and/or bicycle paths and provision of bicycle racks; the proportion of the total parking required that is represented by the requested reduction; the proportion of the total parking required that is decreased by Sec. 28.141. The characteristics of the use, including hours of operation and peak parking demand times design and maintenance of off-street parking that will be provided; and whether the proposed use is now or a small addition to an existing use.*

Not Applicable

11. *When applying the above standards to telecommunication facilities, the Plan Commission shall consider the review of the application by a professional engineer required by Sec. 28.143. 12. When applying the above standards to an application for height in excess of that allowed in the district, the Plan Commission shall consider recommendations in adopted plans; the impact on surrounding properties, including height, mass, orientation, shadows and view; architectural quality and amenities; the relationship of the proposed building(s) with adjoining streets, alleys, and public rights of ways; and the public interest in exceeding the district height limits.*

Not applicable.

13. *When applying the above standards to lakefront development under Sec. 28.138, the Plan Commission shall consider the height and bulk of principal buildings on the five (5) developed lots or three hundred (300) feet on either side of the lot with the proposed development.*

Not applicable.

14. *When applying the above standards to an application for height in excess of that allowed by Section 28.071(2)(a) Downtown Height Map for a development located within the Additional Height Areas identified in Section 28.071(2)(b), the Plan Commission shall consider the recommendations in adopted plans, and no application for excess height shall be granted by the Plan Commission unless it finds that all of the following conditions are present: a. The excess height is compatible with the existing or planned (if the recommendations in the Downtown Plan call for changes) character of the surrounding area, including but not limited to the scale, mass, rhythm, and setbacks of buildings and relationships to street frontages and public spaces. b. The excess height allows for a demonstrated higher quality building than could be achieved without the additional stories. c. The scale, massing and design of new buildings complement and positively contribute to the setting of any landmark buildings within or adjacent to the projects and create a pleasing visual relationship with them. For projects proposed in priority viewsheds and other views and vistas identified on the Views and Vistas Map in the City of Madison Downtown Plan, there are no negative impacts on the viewshed as demonstrated by viewshed studies prepared by the applicant.*

Not applicable.

15. *When applying the above standards to an application to redevelop a site that was occupied on January 1, 2013 by a building taller than the maximum building height allowed by Section 28.071(2)(a) Downtown Height Map, as provided by Section 28.071(2)(a)1., no application for excess height shall be granted by the Plan Commission unless it finds that all the following additional conditions are also present: a. The new building is entirely located on the same parcel as the building being replaced. b. The new building is not taller in stories or in feet than the building being replaced. c. The new building is not larger in total volume than the building being replaced. d. The new building is consistent with the design standards in Section 28.071(3) and meets all of the dimensional standards of the zoning district other than height. e. The Urban Design Commission shall review the proposed development and make a recommendation to the Plan Commission.*

Not applicable.



Downtown Design Guidelines

A. Site Design + Building Placement

1) Orientation

Buildings create and spatially define the public space (streets and sidewalks), and how a building faces this public way is a primary factor in what it contributes to the urban character of an area by reinforcing a consistent street wall and enhancing the pedestrian realm.

- a. **Any building façade adjacent to a street should address the street and reinforce the density of the urban block form created by the boundaries of the property line and adjacent built forms built to the property line of the street.**
The proposed building design reinforces both University/Gorham Avenue and Gilman Street through building placement adjacent to the sidewalks with retail and residential uses at the first floor.
- b. **Buildings should be sited so that portions of the building designed for service uses, such as loading docks and dumpster enclosures, are not part of the street façade. When a lot configuration requires such activities from a street, these components should be architecturally integrated into the design of the façade.**
The service area will be access off of the Gilman Street façade and will be architecturally integrated into the design of the façade.
- c. **The street level of a building should be designed with active uses and architecture that engages the street/sidewalk in a contextually appropriate manner, and integrates the building architecture and the landscape architecture.**
Retail and residential uses have direct access and integration with the adjoining streetscapes.
- d. **Buildings should be oriented to preserve and enhance the views identified on the Views and Vistas Map in the Downtown Plan.**
No prominent views and vistas are impacted by the project which is conforming with the overall height regulations for this site.
- e. **Buildings at the intersection of streets should have a strong corner presence.**
Not Applicable

2) Access + Site Circulation

How people, bicycles, and motor vehicles access a site and circulate within it and around it can be a critical determinant in how it relates to its context. A primary goal is to maximize uninterrupted pedestrian access within a given block to enhance and maintain all areas of the Downtown as pedestrian friendly. Another goal is to minimize the visual presence of motor vehicle circulation, parking, and service functions, including minimizing the visual impact of parking structures and parking lots on the streetscape.

The pedestrian experience along each street is maintained and enhanced through first floor retail/residential uses and minimized vehicular and service entrances.

Pedestrian/Bicycle Entrances: The primary building entrances are along University/Gorham Avenue through either the student or market rate lobby.

Vehicles: The vehicular entrance is placed along Gorham Avenue.

Service: The loading docks are located along Gilman Street and will be fully enclosed.

- a. **Parking facilities beneath a building should not be considered a valid reason to establish an occupiable first floor more than three (3) feet above the grade of the sidewalk along any adjacent street, nor to include long segments of blank wall on any side of a building.**
Retail and residential entrances are programmed to be at sidewalk grade on all three streets.

- b. **Driveways should be oriented 90 degrees to the street, and shared driveways are encouraged. Designs should provide clear vision of pedestrians on sidewalks crossing any driveway.**

The University Avenue access is 90 degrees to the street and will be designed to maintain site triangles/visual access with the sidewalk.

- c. **Porte-cochere type entries, drop offs, or circular drives should not be parallel to the street or within the right-of-way, nor should they be oriented to require more than one curb cut. Queuing space for motor vehicles should not impede pedestrian movement along any public sidewalk nor be designed in such a manner that it unnecessarily widens the driveway.**

Not included in design.

3) Usable Open Space + Residential Development

Residents living in this densely developed portion of the city enjoy a variety of conveniently located urban amenities and may not require the amount of on-site usable open space as other parts of the community. However, the provision of quality on-site useable open space is necessary to create a quality living environment.

- a. **Project designs should provide attractive, safe and creatively designed yards, courtyards, plazas, sitting areas or other similar open spaces for building residents.**
The building will feature unique amenity spaces on the second floor as well as balconies and a rooftop open space. These features will be available to residents of the student and market rate units
- b. **All residents should have access to some form of open space, whether it is private (such as patios or balconies) or common open space (such as yards or roof decks). A suggested minimum size for a balcony is 4.5 feet by 8 feet.**
See a. above.
- c. **At some locations, side and rear yards sufficient to provide usable open space may be limited, and outdoor open space may not represent the most beneficial use of a limited site when the overall density of development is relatively high. Common recreational facilities and social activity spaces in the development may be considered toward meeting some of the need for usable open space. "Permeable" first floor spaces that provide an opportunity for indoor activities to extend to outdoor spaces are encouraged.**
See a. above.

4) Landscaping

How a site is landscaped-- particularly in a dense urban environment-- can "soften" hard edges, make a site more inviting, and bring color and interest to a development. Well landscaped sites also create informal gathering spaces and enhance the adjoining public improvements.

The site is proposed for an urban setting with urban streetscape elements abutting the site. The building will be setback along Gorham Street to accommodate a wider sidewalk. The first floor Gilman Street residential units will have a landscape separation from the sidewalk, per the zoning code requirement. The building will also feature a landscaped rooftop open space and some green roof elements.

- a. **The design emphasis should be on creating an "urban" landscape, incorporating site amenities such as linear planting beds or seat walls, street furniture, public art, lighting, and landscape materials. These features should be architecturally compatible with the styles, materials and colors of the principal building on the lot and those in the immediate area.**

The project is designed to maintain the adjoining streetscape landscape with limited impacts on the adjoining streetscape. The buildings is setback along a portion of the University Avenue/Gorham Avenue frontage to create a consistent useable sidewalk of 15' in width along the project.



b. **Context appropriate landscaping should be provided along the front façade.** Appropriate landscaping will depend on factors such as the setbacks, shape, size, and orientation of the building.
Met

c. **Plant species should be selected based on their compatibility with an urban environment.** Planting environments should be designed to provide plants the greatest potential to grow to maturity in a healthy state, such as use of planting beds, structural soils to promote root growth, and considering salt tolerance. Ease of maintenance should also be considered.
Met

d. **Public art should be encouraged where it is an integral part of the design approach to these spaces.**
Not applicable

e. **Outdoor seating areas and cafes on private property are encouraged provided they do not interfere with pedestrian flow and circulation along the sidewalk and from public ways to building entries or amenities, such as bicycle racks and benches.**

f. **Canopy trees should be encouraged and planted to imply human-scale spaces and mitigate the urban heat island effect. Where canopy trees are used, site design should provide sufficiently sized tree pits or planting beds and appropriate planting medium to provide for healthy tree growth.**
The adjoining streetscapes will be re-built as urban cross sections along University Avenue and will be maintained along Gilman Street.

5) Lighting

Appropriate site and building lighting can create interest and a safe and welcoming environment. Lighting can also reinforce architectural elements such as entries, structural bays, or shop windows. Excessively lighting a site or building can create glare and greatly detract from the ambiance of a street, while insufficiently lighting a site can result in dark spots and raise safety issues.

a. **Exterior lighting to accentuate the building architecture and landscaping should not be excessive in either amount or intensity.**

Will be detailed as part of a separate Signage and Lighting Submittal

b. **Building entrances and entryways and other walkways should be lit sufficiently to create inviting and safe building access.**

Will be detailed as part of a separate Signage and Lighting Submittal

c. **Building-mounted fixtures should be compatible with the building facades.**

Will be detailed as part of a separate Signage and Lighting Submittal

d. **Full cut-off fixtures should be used. Lighting should not spill into the sky, encroach on neighboring properties, nor cause excessive glare.**

Will be detailed as part of a separate Signage and Lighting Submittal

e. **The lighting on the top of a building should not compete with the view of the Capitol dome in views of the skyline.**

Will be detailed as part of a separate Signage and Lighting Submittal

B. Architecture

1) Massing

Building massing is an important determinant in the quality of the urban environment and in how “welcoming” a street is perceived. Important aspects to this specifically related to massing include the preservation of natural light, sunlight and ventilation to the street, as well as preventing the feeling that large buildings are looming over the street and creating a canyon effect. The mass of a building can also enhance the pedestrian experience by creating more human-scaled development.

The overall building design creates a modern take on a traditional loft building and is designed to create a well designed and proportional building composition.

The massing of the building exceeds the zoning code setback requirements with a setback at the second floor along both Gilman Street and University/Gorham Avenue. The setback along Gilman Street includes the preservation of the existing facade and setback at the existing parapet to maintain the character of the streetscape.

Shadow studies have been included in the application.

a. **The proportions and relationships of the various architectural components of the building should consider the scale of other buildings in the vicinity. In areas where the Downtown Plan recommends significantly taller or larger buildings than currently exist, this guideline should consider the evolving context.**

The massing of the building is consistent with the surrounding buildings and Downtown Plan recommendations.

b. **Larger buildings should solve any problems that their scale may create to ensure a pedestrian-friendly quality. Articulation of buildings in both plan and profile may help break up the mass of large buildings. Stepping back the upper floors from lower floors may be appropriate to minimize overall scale and minimize shadow effects.**

The articulation of the building architecture is consistent with the surrounding buildings.

c. **The mass of a building should not negatively impact views identified on the Views and Vistas Map in the Downtown Plan. Applicants may need to prepare viewshed studies for others to fully understand potential impacts.**

No prominent views and vistas are impacted by the project which is conforming with the overall height regulations for this site.

d. **Shadow studies may need to be prepared by the applicant for buildings that adjoin public open spaces, or streets and sidewalks with particularly heavy pedestrian volumes, to demonstrate that these important public spaces are not negatively impacted by excessive amounts and/or durations of shadows.**

Shadow studies have been included in the packet.

2) Building Components

Most buildings are experienced from a variety of perspectives, which change as a person moves about the city. Correspondingly, how the top, middle, and base of a building are designed also influences these interactions, and all must work within a complete architectural form. The Downtown Plan places an emphasis on creating an interesting skyline that reflects the underlying topography, and the design of the top of a building influences the skyline. Likewise, the Plan places an emphasis on making great public spaces, streets, and engaging pedestrian environments, and the design of a building's lowest four floors define the public realm and are the primary contributor to a pedestrian's perception of a street.

The building design creates a strong and unique pedestrian experience along the adjoining streets with retail facades along University/Gorham Avenue and the preserved facade along Gilman Street. This design aesthetic is carried throughout the building to include a strong urban roof form and integrated mechanical screening.

a. **The lower levels of street facing facades should generally incorporate a higher level of visual interest and richer architectural detailing. One way to achieve this is to locate active use areas on lower level street side spaces within a building, which could be reflected in the exterior architecture of the corresponding facades.**

Met



- b. A positive visual termination at the top of the building should be an integral part of the design from both the distant view and the pedestrian perspective. A positive visual termination could include projections or relief from the building façade or visual interest in the building form as it meets the sky.

Met

- c. Roof forms should be used to integrate rooftop equipment, telecommunications equipment, and other devices so as to express/conceal them as architectural elements. Large mechanical penthouses and elevator overrides should be fully integrated into the building architecture and be appropriately-scaled to serve as architectural features and avoid the appearance of being “plopped” on top.

Met

3) Visual Interest

As emphasized in the Downtown Plan, it is especially important to create a comfortably-scaled and thoughtfully detailed urban environment through the use of well-designed architectural forms and details. Well-designed buildings add visual interest and variety to the massing of a building, help define the public space, engage the street, create an interesting pedestrian environment, and help break up long, monotonous facades. Articulation also is a primary means of providing a human scale through change in plane, contrast and intricacy in form, color, and materials.

The building is designed to fit into the surrounding context with "four sided" architecture and a strong overall design composition.

- a. Buildings should have an overall design composition with a secondary and tertiary composition within it. All sides should have a similar design composition and quality of materials that make a positive contribution to the built urban environment.

Met

- b. Franchise corporate/trademark building designs should be altered to fit the desired character of the district.

To be determined based on future tenant needs.

- c. The design of buildings fronting on State Street should reflect the historic pattern and rhythm of storefront bays on the lower level. If the interior space is wider, each bay should be articulated and have the ability to create its own entrance. A combination of good physical features and varied activities should result in a livelier street.

Met

- d. Balconies should not extend over the public right-of-way.

Met

4) Door and Window Openings

As emphasized in the Downtown Plan, it is especially important to create a comfortably-scaled and thoughtfully detailed streetscape and how the openings in building walls (windows, doors, etc.) are incorporated have an influence on the perception of a building's mass and how it is experienced by pedestrians.

- a. The size and rhythm of windows and doors in a building should respect those established by existing buildings in the area where a clear pattern exists, and the residential and/or mixed-use nature of the building.

Met

- b. Existing traditional buildings should not have window openings with different sash configurations, smaller windows, or materials inappropriate to the original design. Transom windows should remain transparent/translucent.

Not applicable

- c. Entrances, including doors, should be sized and articulated in proportion to the scale of the building and should be architecturally compatible with the style, materials, and details of the building as a whole. Entrance definition and articulation may be achieved through use of architectural elements such as: lintels, pediments, pilasters, columns, porticoes, porches, overhangs, railings, balustrades, and others, where appropriate.

Met

5) Building Materials

The Downtown Core and Urban Mixed Use Districts are generally the most dense and heavily used areas of the city, and buildings in these districts are exposed to a high level of use. An integrated palette of high quality, durable building materials can enrich the pedestrian environment through the use of scale, color, texture, and architectural details.

- a. A variety of complementary exterior building materials may be incorporated to provide visual interest to the building. The palette of materials should not be overly complex.

Met

- b. All sides of a structure should exhibit design continuity and be finished with high quality materials. Materials should be those typically found in urban settings.

Met

- c. If material changes are proposed, they should generally occur at inside corners or be delineated by a specific transitional detail such as a pronounced belt course or substantial reveal.

Met

6) Terminal Views and Highly-Visible Corners

The design of buildings occupying sites located at the end of a street, on a highly-visible corner, or in other prominent view sheds can serve as a focal point and the design of such structures should reflect the prominence of the site. Particular attention should be paid to views from these perspectives.

- a. Corner buildings should define the street intersection with distinctive architectural features such as tower elements, rounded walls, recessed entries or other design features.

The building design reinforces the curved nature of this highly visible corner of University/Gorham Street and creates a new end-cap to the Bassett Street terminus.

- b. Buildings located at visual focal points should demonstrate a higher degree of architectural strength to emphasize their location.

Met

- c. New buildings on flatiron corners, as identified in the Downtown Plan, should include a design approach that reflects the acute angles of the site.

Not applicable.

7) Awnings and Canopies

Awnings can add color and texture to a streetscape, provide shelter for pedestrians and protect storefront displays from sun exposure.

- a. Awnings should not be internally illuminated so that they glow and become beacons that attract attention to the establishment.

Met



- b. Awnings and canopies should be compatible with building design in terms of the rhythm and design of the storefront bays, material, details, massing, and form.**

Met

- c. Awnings and canopies should not cover up architectural details.**

Met

8) Signage

Signage is for the purpose of identifying a business in an attractive and functional manner rather than to serve as general advertising for a business. Well conceived signage can contribute positively to the character of a street or district. Too many signs and too much information on one sign can overwhelm a viewer and make a sign less effective, and too much signage on a building, block, or street can easily result in visual clutter. The guidelines below are in addition to the requirements of the Madison Sign Code.

- a. Signage should be integrated with and be compatible with the architectural scheme of a building.**

Will be detailed as part of a separate Signage and Lighting Submittal

- b. Messages should be simple-- only including the name, address, function (i.e. restaurant), and logo of the establishment.**

Will be detailed as part of a separate Signage and Lighting Submittal



Exhibit A: Legal Description

Metes and Bounds Description CSM Boundary

All of Lots 4 and 8 and part of Lots 3 and 7, Block 10, University Addition to Madison, as recorded in Volume A of Plats, on page 9, also part of Lots 14, 15, 16 and 17, Block 39, Original Plat of Madison, as recorded in Volume A of Plats, on page 3, Dane County Registry, located in the Northeast Quarter of the Northwest Quarter and the Northwest Quarter of the Northeast Quarter of Section 23, Township 07 North, Range 09 East, City of Madison, Dane County, Wisconsin, more fully described as follows:

Commencing at the North Quarter corner of said Section 23; thence South 00 degrees 00 minutes 50 seconds West, 415.09 feet; thence South 46 degrees 23 minutes 58 seconds West, 15.06 feet to the point of beginning; thence North 46 degrees 23 minutes 58 seconds East, 99.27 feet; thence South 43 degrees 15 minutes 27 seconds East, 132.31 feet to the north right of way of West Gorham Street; thence South 46 degrees 36 minutes 02 seconds West along said north right of way, 133.33 feet; thence South 68 degrees 57 minutes 22 seconds West along said north right of way, 52.70 feet to the north right of way of University Avenue; thence North 88 degrees 46 minutes 48 seconds West along said north right of way, 158.36 feet; thence North 46 degrees 23 minutes 58 seconds East, 96.58 feet; thence North 43 degrees 45 minutes 15 seconds West, 131.81 feet to the south right of way of West Gilman Street; thence North 46 degrees 19 minutes 48 seconds East along said south right of way, 99.24 feet; thence South 43 degrees 46 minutes 06 seconds East, 131.93 feet to the Point of Beginning. This description contains 42,946 square feet or 0.9859 acres.



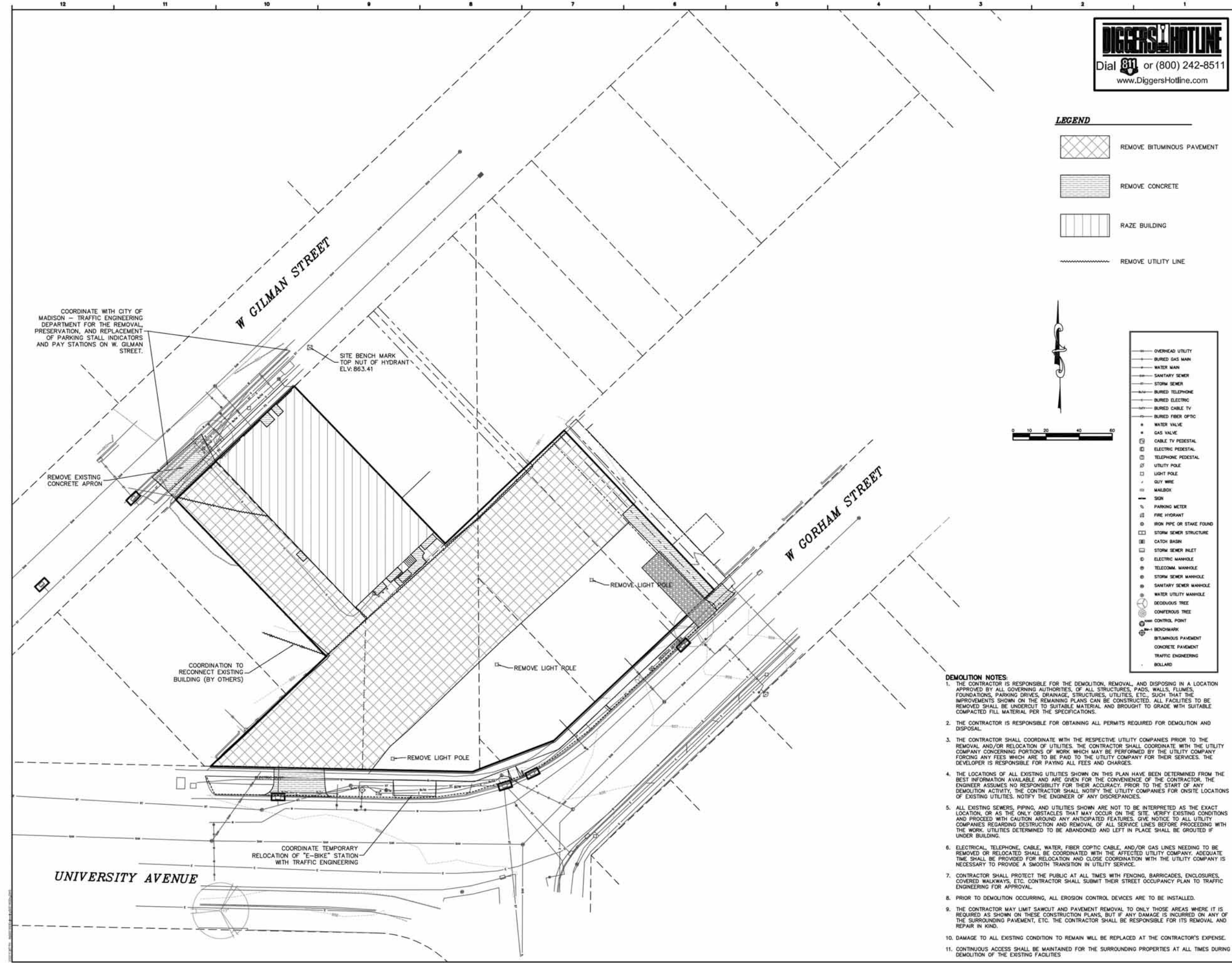

DIGGERS HOTLINE
 Dial 811 or (800) 242-8511
 www.DiggersHotline.com

General Notes:

No.	Date	Description
1	02/24/2015	Conditional Use Submittal

Submissions & Revisions

CORE

General Contractor

Architect
ANTUNOVICH ASSOCIATES
 ARCHITECTS
 214 West Walnut Street
 Madison, Wisconsin 53703
 Phone: 608-255-0000
 Fax: 608-255-0001
 Website: antunovich.com

Associate Architect

Structural Engineer

Mechanical and Plumbing Engineers

Electrical Engineer

Civil Engineer
Burse
 2007 Wisconsin Ave., Suite 200
 Madison, WI 53704
 Phone: 608-255-0000
 Fax: 608-255-0001
 Website: burse.com

Landscaping Architect
Land Design
 400 N. Regis Ave.
 Madison, WI 53704
 Phone: 608-255-0000
 Fax: 608-255-0001
 Website: landdesign.com

Project Location:
HUB AT MADISON II
 510 University Avenue
 Madison, WI 53703

Drawing Title:
DEMOLITION PLAN

Scale:
 1" = 10'-0"

Date:
 02/03/2015

Drawing No.:
C-200

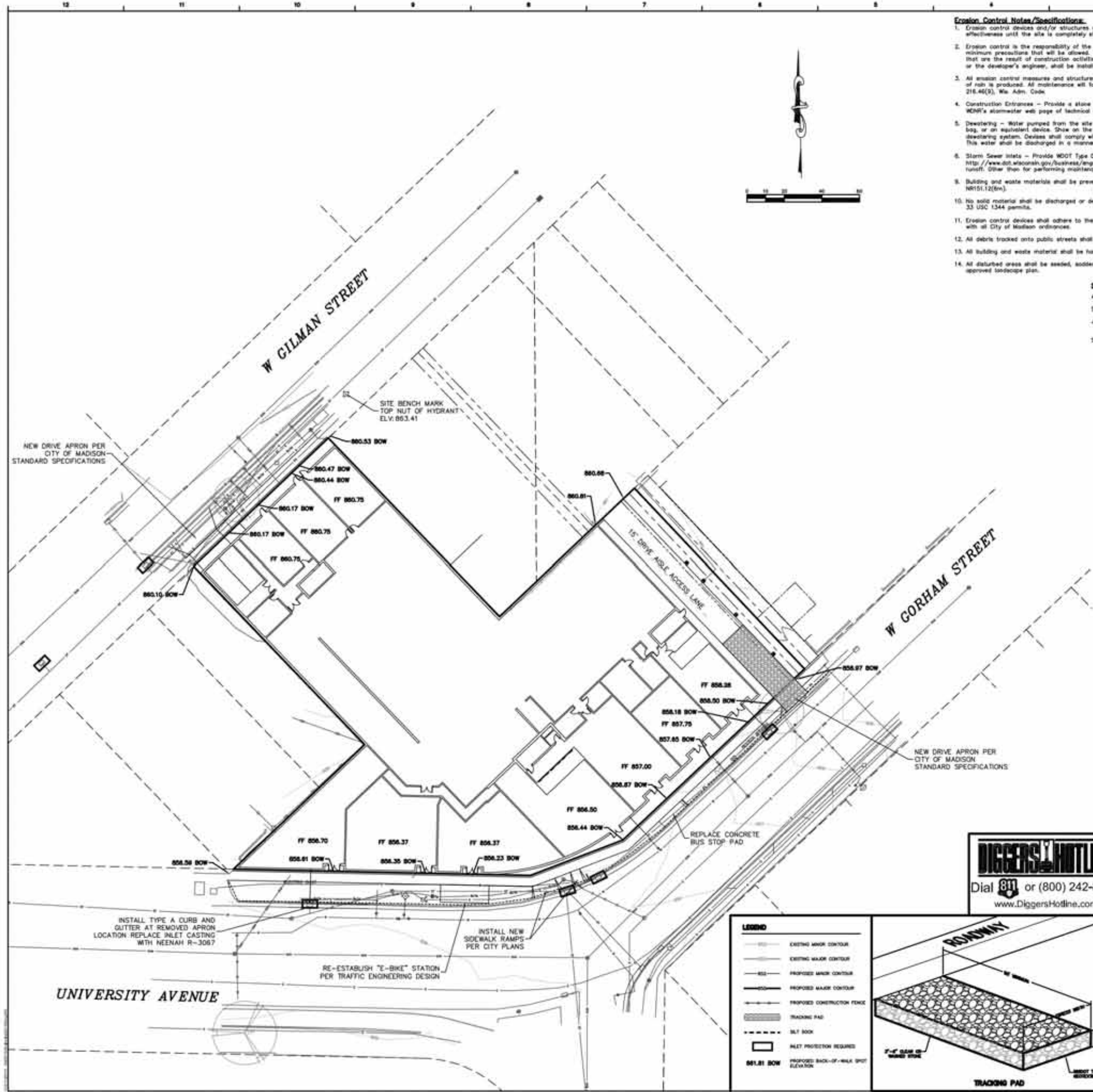

- Erosion Control Notes/Specifications:**
- Erosion control devices and/or structures shall be installed prior to demolition operations. These shall be properly maintained for maximum effectiveness until the site is completely stabilized.
 - Erosion control is the responsibility of the contractor until acceptance of this project. Erosion control measures as shown shall be the minimum precautions that will be allowed. The contractor shall be responsible for recognizing and correcting all erosion control problems that are the result of construction activities. Additional erosion control measures, as requested in writing by the state or local inspectors, or the developer's engineer, shall be initiated within 24 hours.
 - All erosion control measures and structures serving the site must be inspected at least weekly or within 24 hours of the time 0.5 inches of rain is produced. All maintenance will follow an inspection within 24 hours. Inspection schedule and record keeping shall comply with MR 216.40(3), Wis. Adm. Code.
 - Construction Entrances - Provide a stone tracking pad at each point of access, install according to WDRR Standard 1057. Refer to WDRR's stormwater web page of technical standards at: <http://dr.wis.gov/runoff/stormwater/techstds.htm>
 - De-watering - Water pumped from the site shall be treated by using a temporary sedimentation basin, portable dewatering basin, geotextile bag, or an equivalent device. Show on the plan the anticipated locations of dewatering activity, and provide an engineering detail of the dewatering system. Devices shall comply with WDRR Technical Standard 1051 found at <http://dr.wis.gov/runoff/stormwater/techstds.htm>. This water shall be discharged in a manner that does not induce erosion of the site or adjacent property.
 - Storm Sewer Intake - Provide WDOT Type O "CatchAll" inlet protection or equivalent. Refer to WDOT Product Acceptability List at: <http://www.dot.wisconsin.gov/business/engineering/pal.htm>. Inlet protection shall be installed prior to the storm sewer system receiving site runoff. Other than for performing maintenance, these devices shall not be removed until site stabilization is complete.
 - Building and waste materials shall be prevented from running-off the site and entering waters of the state in conformance with NR151.12(6m).
 - No solid material shall be discharged or deposited into waters of the state in violation of Ch. 30 or 31 of the Wisconsin State Statutes or 33 USC 1344 permits.
 - Erosion control devices shall adhere to the technical standards found at: <http://dr.wis.gov/runoff/stormwater/techstds.htm> and comply with all City of Madison ordinances.
 - All debris tracked onto public streets shall be swept or scraped clean by the end of each workday.
 - All building and waste material shall be handled properly to prevent runoff of these materials off of the site.
 - All disturbed areas shall be seeded, sodded, or otherwise restored immediately after grading activities have been completed per the approved landscape plan.

Schedule:

August 17, 2015	Begin site demolition
September 28, 2015	Begin foundation excavation/building construction
July 1, 2017	Building substantially complete. Restore disturbed areas, install landscape installation.
September 1, 2017	Vegetation established

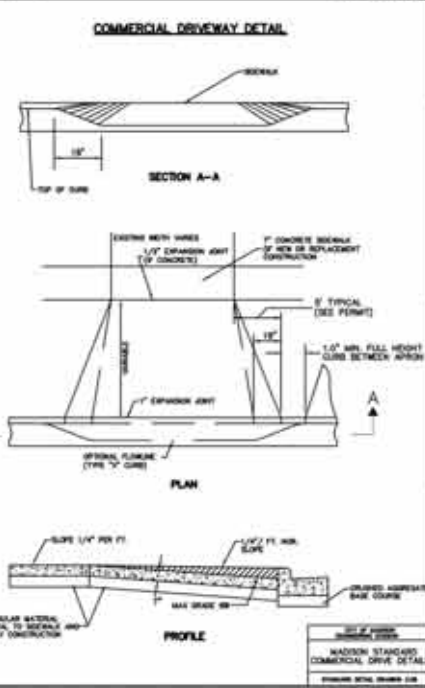
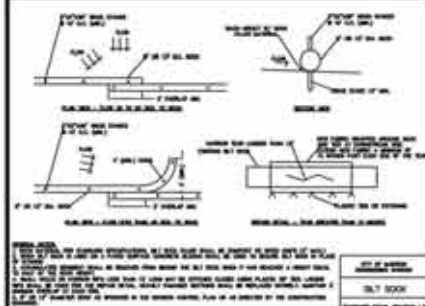
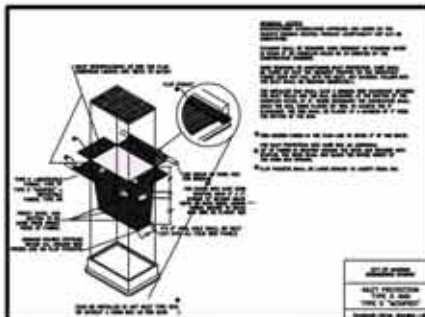

LEGEND

- EXISTING MAJOR CONTOUR
- EXISTING MAJOR CONTOUR
- PROPOSED MAJOR CONTOUR
- PROPOSED MAJOR CONTOUR
- PROPOSED CONSTRUCTION FENCE
- TRACKING PAD
- SILT SOCK
- INLET PROTECTION REQUIRED
- PROPOSED BACK-OF-HILL SPOT ELEVATION

881.81 BOW

TRUCKING PAD

DIGGERS HOTLINE
Dial 811 or (800) 242-8511
www.DiggersHotline.com

HUB AT MADISON II 510 University Avenue Madison, WI 53703	
GRADING AND EROSION CONTROL PLAN	
C-300	

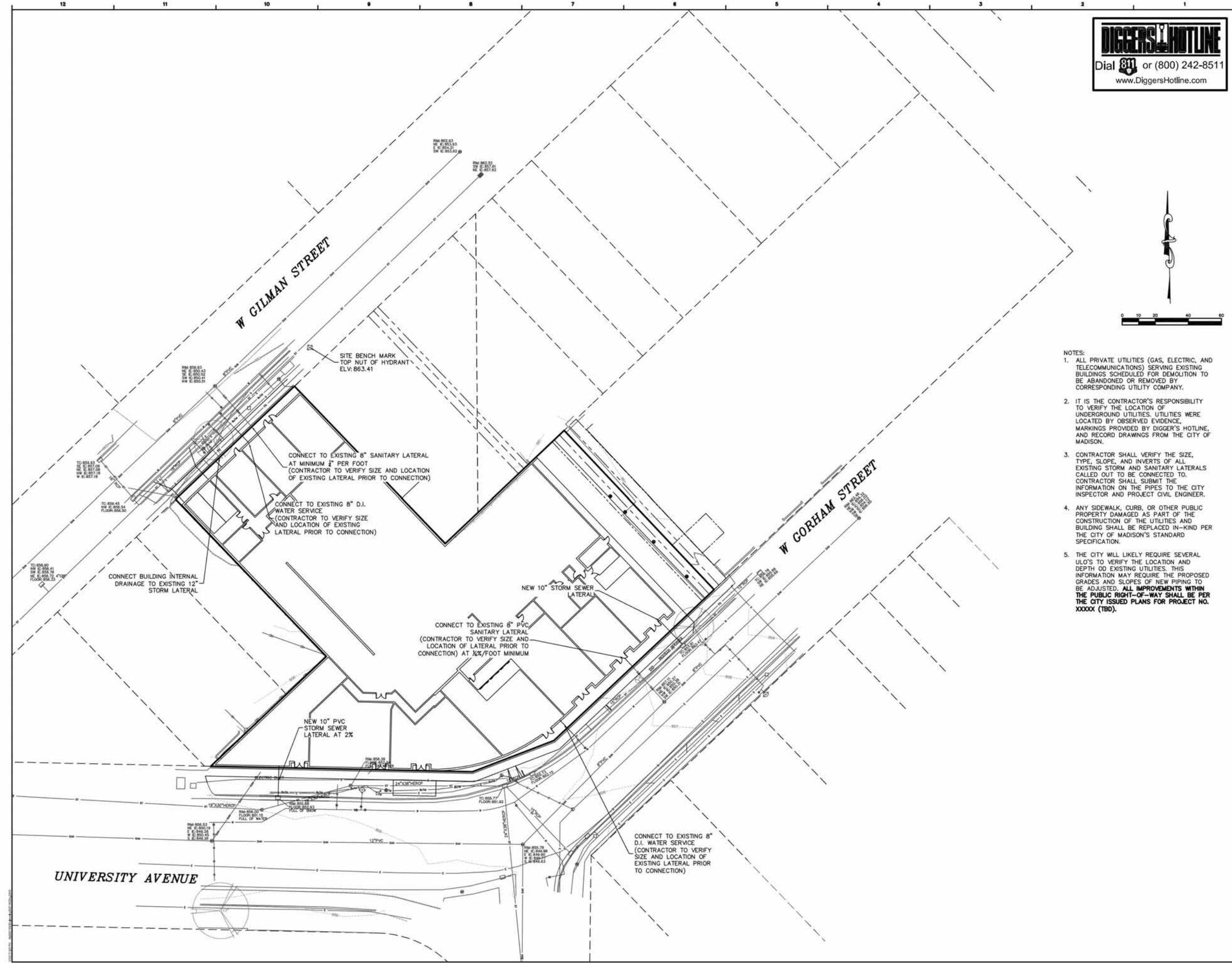

DIGGERS HOTLINE
 Dial 811 or (800) 242-8511
 www.DiggersHotline.com

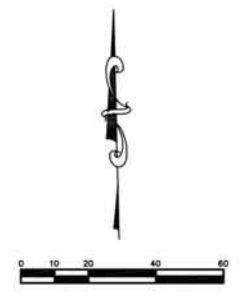

- NOTES:**
1. ALL PRIVATE UTILITIES (GAS, ELECTRIC, AND TELECOMMUNICATIONS) SERVING EXISTING BUILDINGS SCHEDULED FOR DEMOLITION TO BE ABANDONED OR REMOVED BY CORRESPONDING UTILITY COMPANY.
 2. IT IS THE CONTRACTOR'S RESPONSIBILITY TO VERIFY THE LOCATION OF UNDERGROUND UTILITIES. UTILITIES WERE LOCATED BY OBSERVED EVIDENCE, MARKINGS PROVIDED BY DIGGER'S HOTLINE, AND RECORD DRAWINGS FROM THE CITY OF MADISON.
 3. CONTRACTOR SHALL VERIFY THE SIZE, TYPE, SLOPE, AND INVERTS OF ALL EXISTING STORM AND SANITARY LATERALS CALLED OUT TO BE CONNECTED TO. CONTRACTOR SHALL SUBMIT THE INFORMATION ON THE PIPES TO THE CITY INSPECTOR AND PROJECT CIVIL ENGINEER.
 4. ANY SIDEWALK, CURB, OR OTHER PUBLIC PROPERTY DAMAGED AS PART OF THE CONSTRUCTION OF THE UTILITIES AND BUILDING SHALL BE REPLACED IN-KIND PER THE CITY OF MADISON'S STANDARD SPECIFICATION.
 5. THE CITY WILL LIKELY REQUIRE SEVERAL ULO'S TO VERIFY THE LOCATION AND DEPTH OF EXISTING UTILITIES. THIS INFORMATION MAY REQUIRE THE PROPOSED GRADES AND SLOPES OF NEW PIPING TO BE ADJUSTED. **ALL IMPROVEMENTS WITHIN THE PUBLIC RIGHT-OF-WAY SHALL BE PER THE CITY ISSUED PLANS FOR PROJECT NO. XXXX (TBD).**

General Notes		
A		
B		
C		
D		
E		
F		
G		
H		
I		
J		

No.	Date	Description
1	03/03/2015	Conditional Use Submittal

Submissions & Revisions

CORE

General Contractor

Architect
ANTUNOVICH ASSOCIATES
 ARCHITECTS
 214 West Walnut Street
 Madison, Wisconsin 53703
 (608) 255-1111
 Fax: (608) 255-1112
 antunovich.com

Associate Architect

Structural Engineer

Mechanical and Plumbing Engineers

Electrical Engineer

Civil Engineer
Burse
 Consulting and Engineering, Inc.
 2027 Wisconsin Avenue, Suite 200
 Madison, WI 53704
 Phone: (608) 251-2020
 Fax: (608) 251-2021
 burseinc.com

Landscape Architect
Schaefer Land Design
 1014 Park Drive
 Madison, Wisconsin 53704
 schaeferland.com

Project Location
HUB AT MADISON II
 510 University Avenue
 Madison, WI 53703

Drawing Title
UTILITY PLAN

Scale
 Date: 03/03/2015

Drawing No.
C-400

ALL OF LOTS 4 AND 8 AND PART OF LOTS 3 AND 7, BLOCK 10, UNIVERSITY ADDITION TO MADISON, AS RECORDED IN VOLUME A OF PLATS, ON PAGE 9, ALSO PART OF LOTS 14, 15, 16 AND 17, BLOCK 39, ORIGINAL PLAT OF MADISON, AS RECORDED IN VOLUME A OF PLATS, ON PAGE 3, DANE COUNTY REGISTRY, LOCATED IN THE NORTHEAST QUARTER AND THE NORTHWEST QUARTER OF THE NORTHEAST QUARTER OF SECTION 23, TOWNSHIP 07 NORTH, RANGE 09 EAST, CITY OF MADISON, DANE COUNTY, WISCONSIN.



- NOTES**
1. Dates of field work: January 26 and 27, 2015.
 2. Total Parcel Area: 42,946 square feet or 0.9859 acres.
 3. Elevations are based upon NAVD83 datum. The City of Madison monument at the South Quarter corner of Section 14-07-06 has an elevation of 870.32' based upon a stake by Gregory Jones dated 12-16-2008.
 4. Routing of public utilities is based upon markings provided by Digger's Hotline Ticket Numbers 20150422543, 20150422058, 20150402395, 20150402605, 20150402815, 20150402846, 20150404547, drawings obtained from City of Madison Engineering Department and visible aboveground structures. Additional buried utilities/structures may be encountered. No excavations were made to locate utilities. BURSE does not warrant the location of underground utilities. Before excavations are performed contact Digger's Hotline.
 5. No attempt has been made as a part of this survey to obtain or show data concerning condition or capacity of any utility or municipal/public service facility. For information regarding these utilities or facilities, please contact the appropriate agencies.
 6. All surface and subsurface improvements on and adjacent to the site are not necessarily shown hereon. Due to the snow cover at the time of this survey, only visible improvements above the snow or where the snow was removed were located.
 7. All trees, hedges and ground cover on the site may not necessarily be shown hereon.
 8. By graphic plotting only, this parcel is located in Zone X per the Flood Insurance Rate Map Community Panel Number 55022C0409G, dated January 02, 2008.
 9. Except as specifically stated or shown on this map, this survey does not purport to reflect any of the following which may be applicable to the subject real estate: easements, building setback lines, restrictive covenants, subdivision restrictions, zoning or other land use regulations; and any other facts in public or private records.
 10. Surveyor has made no investigation or independent search for assessments of record, encumbrances, restrictive covenants, ownership title evidence, or any other facts that an accurate and current title search may disclose. Surveyor was provided with a Title Commitment Number HCS-709764-MAD dated January 12, 2015 from First American Title Insurance Company, which references the following (numbers in parentheses match items in Schedule B, Section Two of Commitment/Surveyor's notes as in brackets):
 (12) Right of Way disclosed in Instrument recorded November 6, 1947, Volume 506 of Deeds, page 112, as Document No. 755055. [Shown on map] Disclosed as driveway in Land Contract recorded March 4, 1953, Volume 385 of Deeds, page 462, as Document No. 1067782. [Not mappable] Disclosed as Joint Driveway Agreement in Warranty Deed recorded June 21, 1965, Volume 820 of Records, page 116, as Document No. 1165590. [Not mappable]
 (13) P.L.D. (O.D.P. - S.L.P.) Plats recorded May 5, 1992, Volume 18789 of Records, page 52, as Document No. 2350441; Alteration recorded June 20, 1994, Volume 27741 of Records, page 44, as Document No. 2610735. Alteration recorded October 26, 1998, as Document No. 3034906. [Not mappable]
 (14) Reservation and Declaration of Future Cross Easements recorded November 4, 2003, as Document No. 2636552. Affidavit of Correction recorded September 17, 2004, as Document No. 3068921. [Shown on map]
 (15) Easement Easement and Indemnification Agreement recorded January 18, 2004, as Document No. 4154068. [Easement over neighboring parcel for benefit of this parcel]
 11. Zoning: This parcel is zoned UMX (Urban Mixed Used) per City Zoning website.
 12. Building setbacks for UMX zoning per the City of Madison Zoning Code 26.076 are:
 Lot Area: 3,000 sq. ft. Lot Width: 30 feet. Front Yard: Minimum of 0 feet for nonresidential or mixed-use buildings and 5 feet for residential buildings. Maximum of 10 feet. Side Yard: 0 feet. Rear Yard: 10 feet. Maximum lot coverage is 90%. Maximum height is 2 stories. Maximum height 12 stories. Stepback: 15' above 4 stories. Usable Open Space: 10 sq. ft. per bedroom.
 13. There is no observed evidence of current earth moving work, building construction or building additions.
 14. Part of West Gliman Street is under construction at the time of this survey. The area under construction is shown on this map.
 15. There is no observed evidence of site use as a solid waste dump, ramp or solitary landfill.
 16. Adjoining owners names shown on this map are according to City Assessor's website.
 17. There is no observed evidence of striping in the parking lots.
 18. There are no proposed changes to street right of way line per email from the City of Madison.
 19. Primary Address: 510 University Avenue

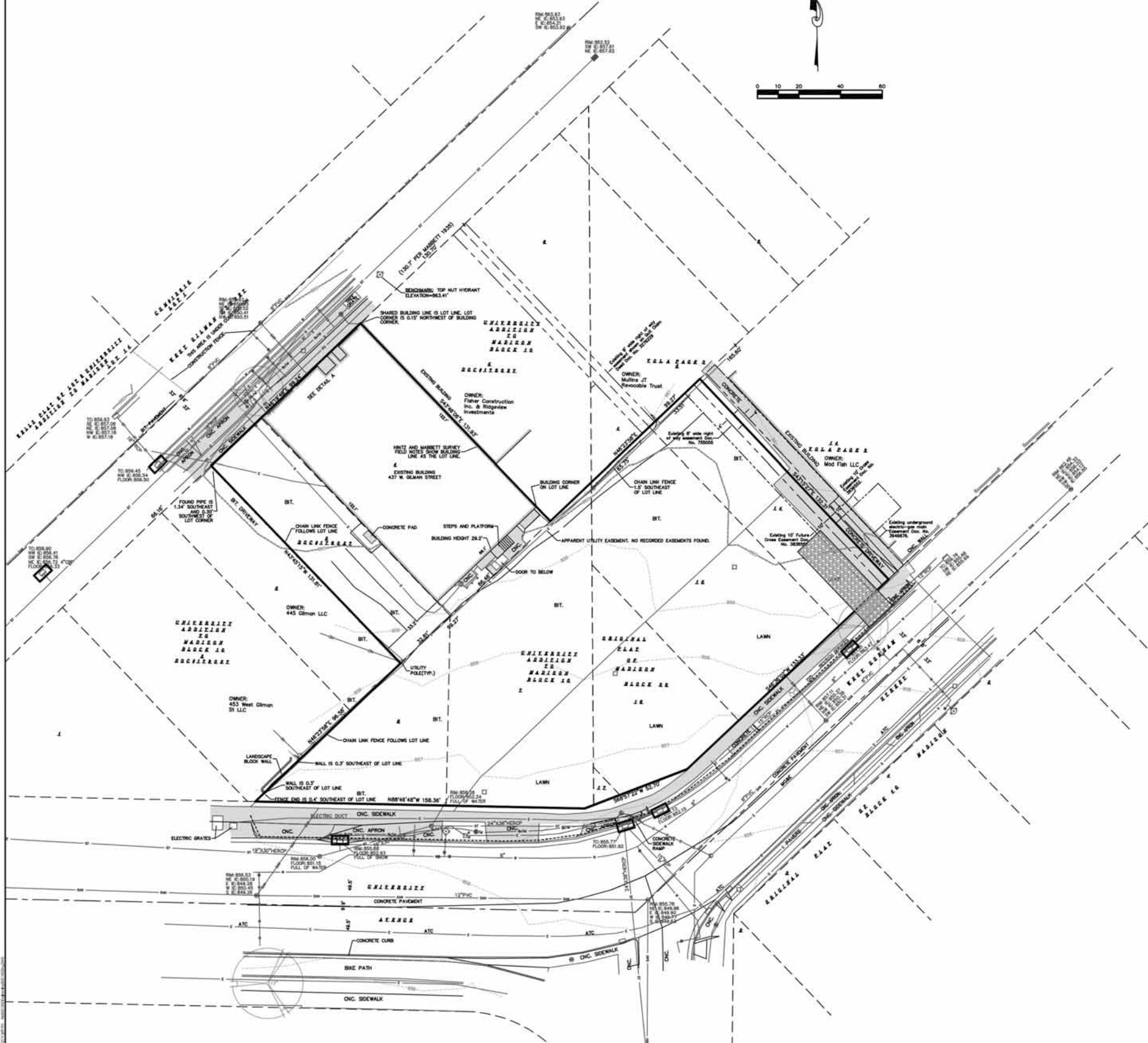

LEGEND	
●	2" SOLID IRON ROD FOUND
○	IRON PIPE FOUND OUTSIDE DIAMETER NOTED
X	FOUND CHISELED "X" IN CONCRETE
●	SET NAIL
●	FOUND NAIL
●	FOUND WAD NAIL
○	3/4" X 1/2" SOLID IRON RE-ROD SET, WT. 1.00 lbs./ft.
—	OVERHEAD UTILITY WIRE
—	BURIED GAS LINE
—	WATER MAIN
—	SANITARY SEWER
—	STORM SEWER
—	BURIED TELEPHONE
—	BURIED ELECTRIC
—	BURIED FIBER OPTIC
●	WATER VALVE
●	GAS VALVE
●	GAS METER
●	AIR CONDITIONER
□	UTILITY POLE
□	LIGHT POLE
○	FIRE HYDRANT
—	SIGN
—	GUY WIRE
□	STORM SEWER INLET
○	ELECTRIC MANHOLE
○	TELEPHONE MANHOLE
○	STORM SEWER MANHOLE
○	SANITARY SEWER MANHOLE
○	HANDHOLE
()	INDICATES RECORDED AS
○	PARKING METER
●	BOLLARD
—	EXISTING CONTOUR MAJOR
—	EXISTING CONTOUR MINOR

General Notes

No.	Date	Description
1	03/03/2015	Conditional Use Submittal

Submissions & Revisions

CORE

General Contractor

Architect

ANTUNOVICH ASSOCIATES

Structural Engineer

Mechanical and Plumbing Engineers

Electrical Engineer

Civil Engineer

Burse

Landscape Architect

Land Design

Project Location

HUB AT MADISON II
510 University Avenue
Madison, WI 53703

Drawing Title

EXISTING CONDITIONS PLAN

Date: 03.03.2015

Drawing No. **C-100**

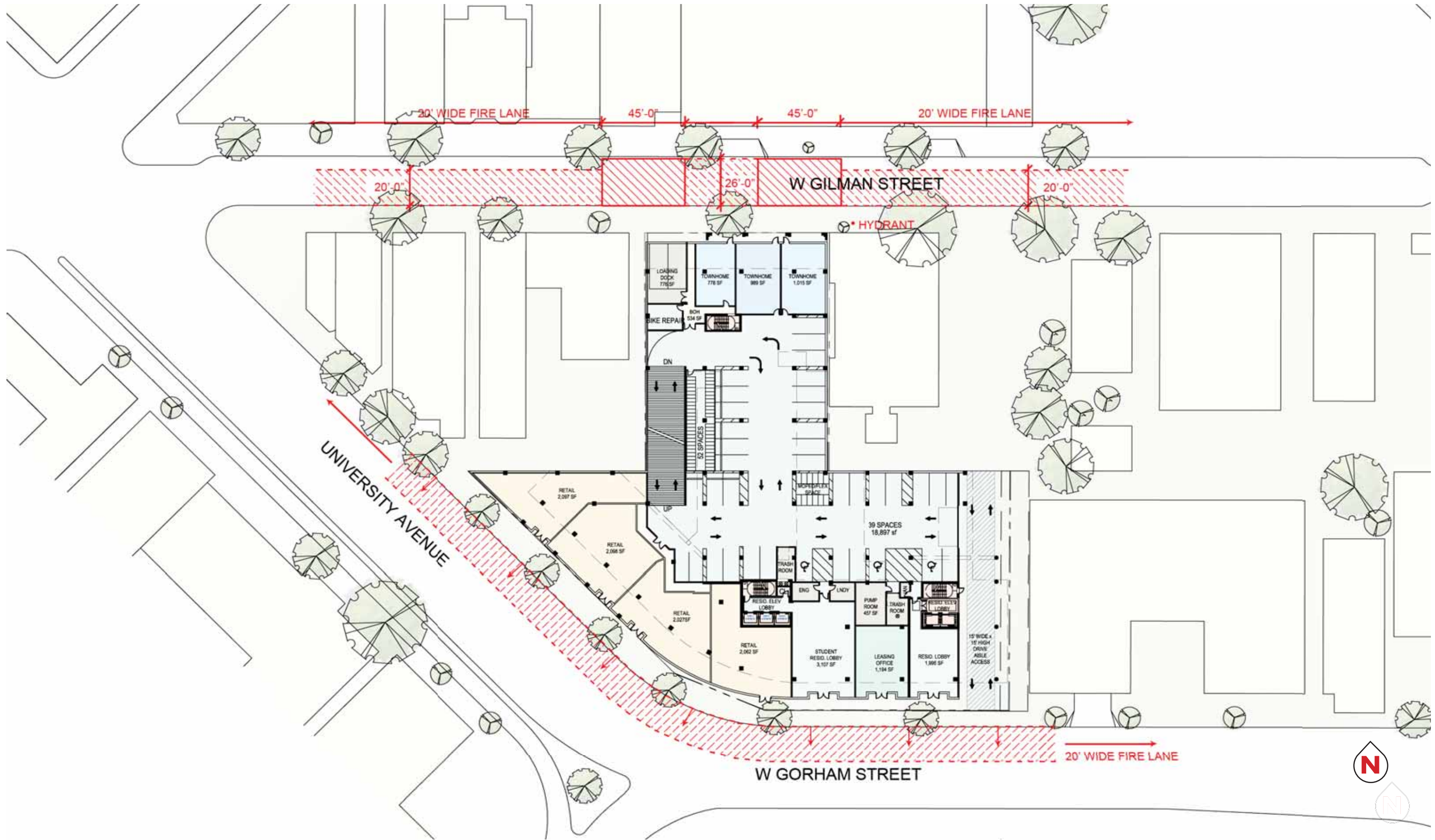



The Hub at Madison II - Conditional Use Application

Core Campus Developers | Antunovich Associates Architecture · Planning



Hub @ Madison I

State Street

N Frances Street

W Gilman Street

N Broom Street

W Gorham Street

University Ave

Hub @ Madison II



The Hub at Madison II - Conditional Use Application

Core Campus Developers | Antunovich Associates Architecture · Planning

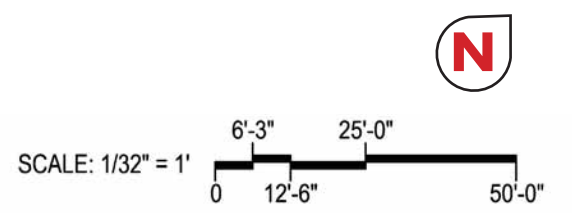
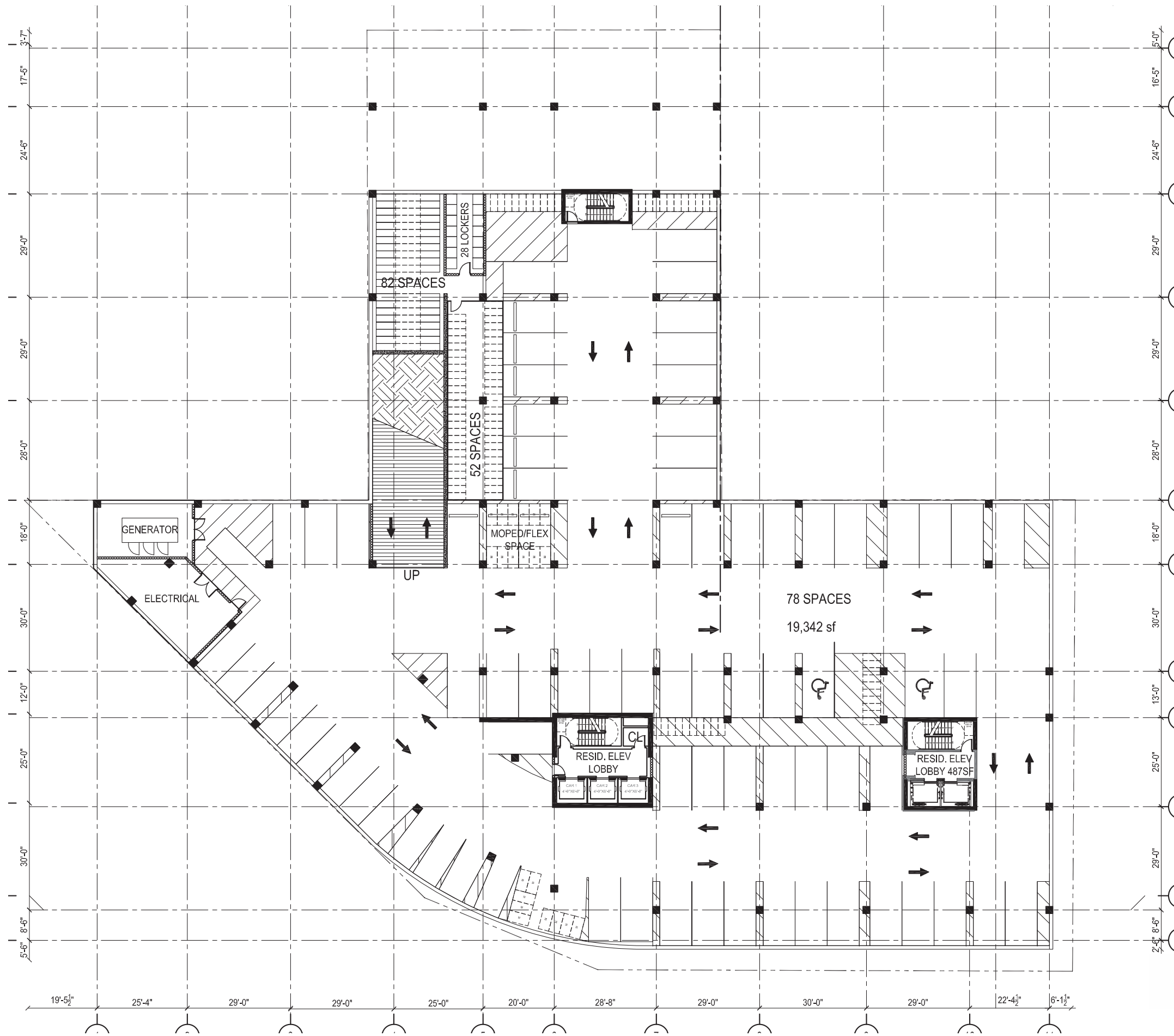

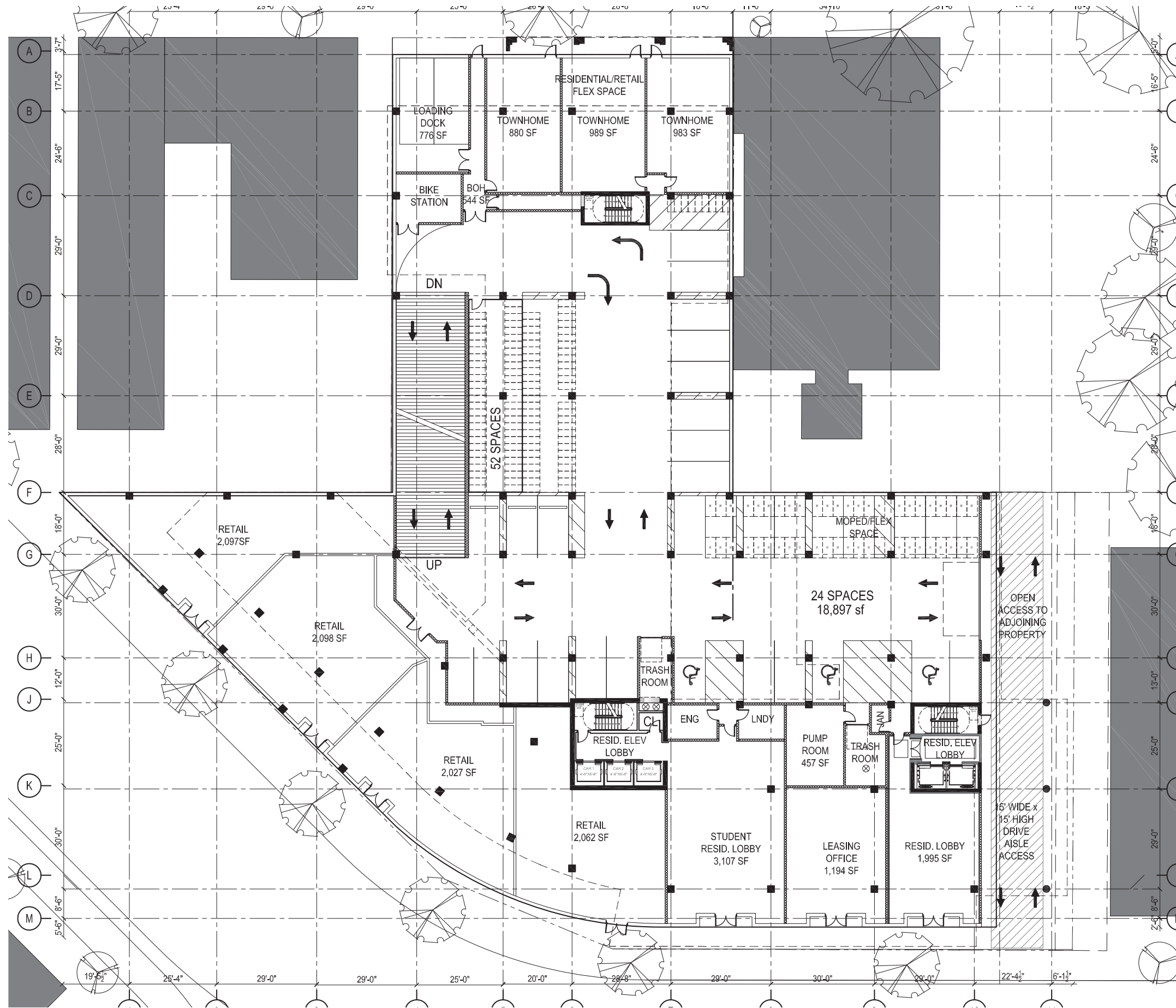

The Hub at Madison II - Conditional Use Application

Core Campus Developers | Antunovich Associates Architecture · Planning

Proposed Ground Floor Plan

Madison, Wisconsin | February 24, 2015

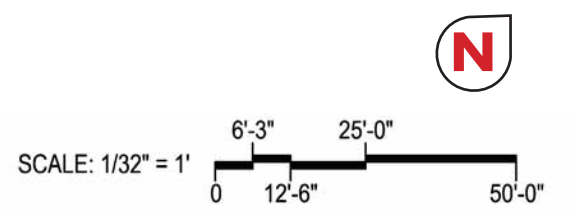
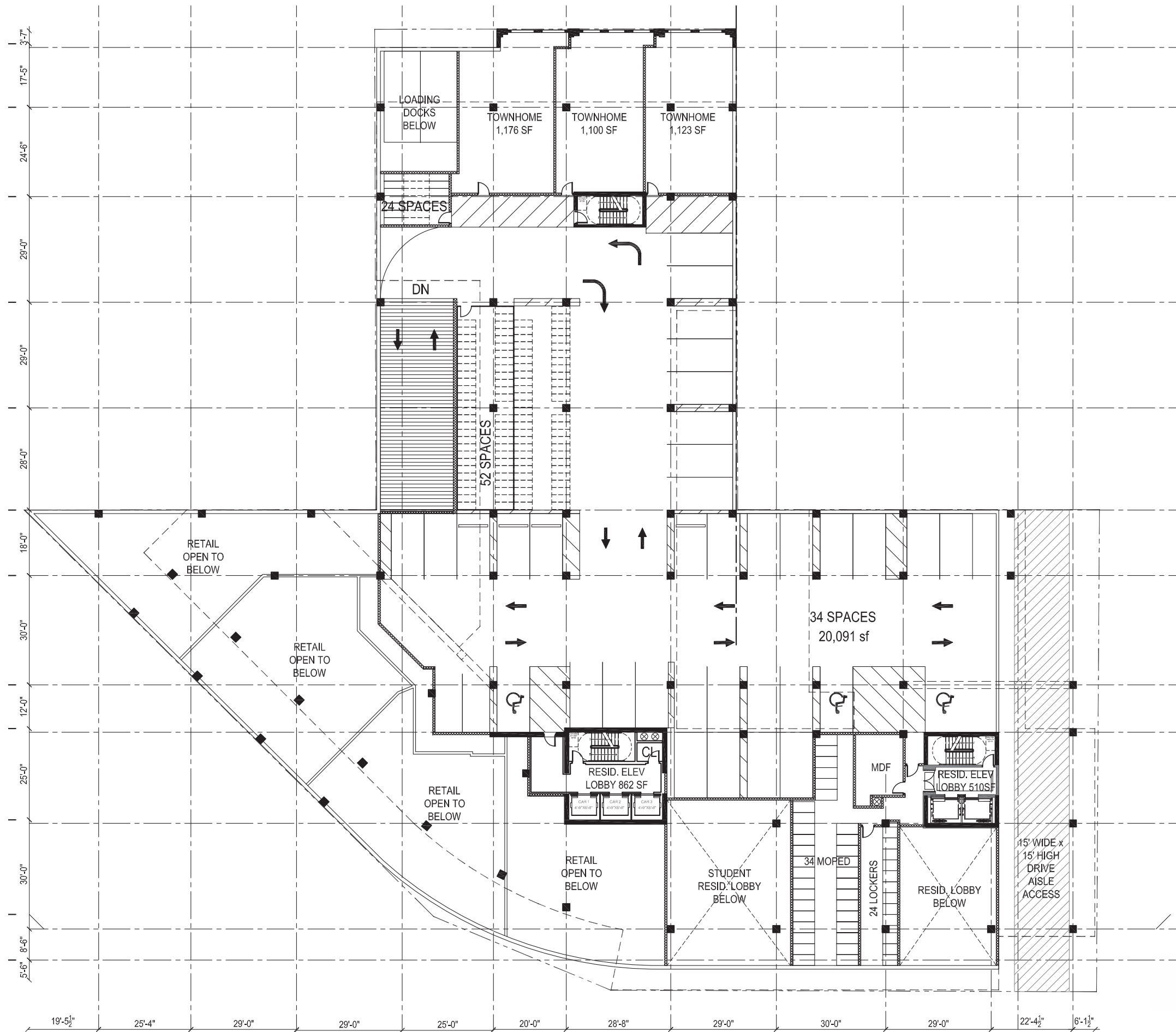

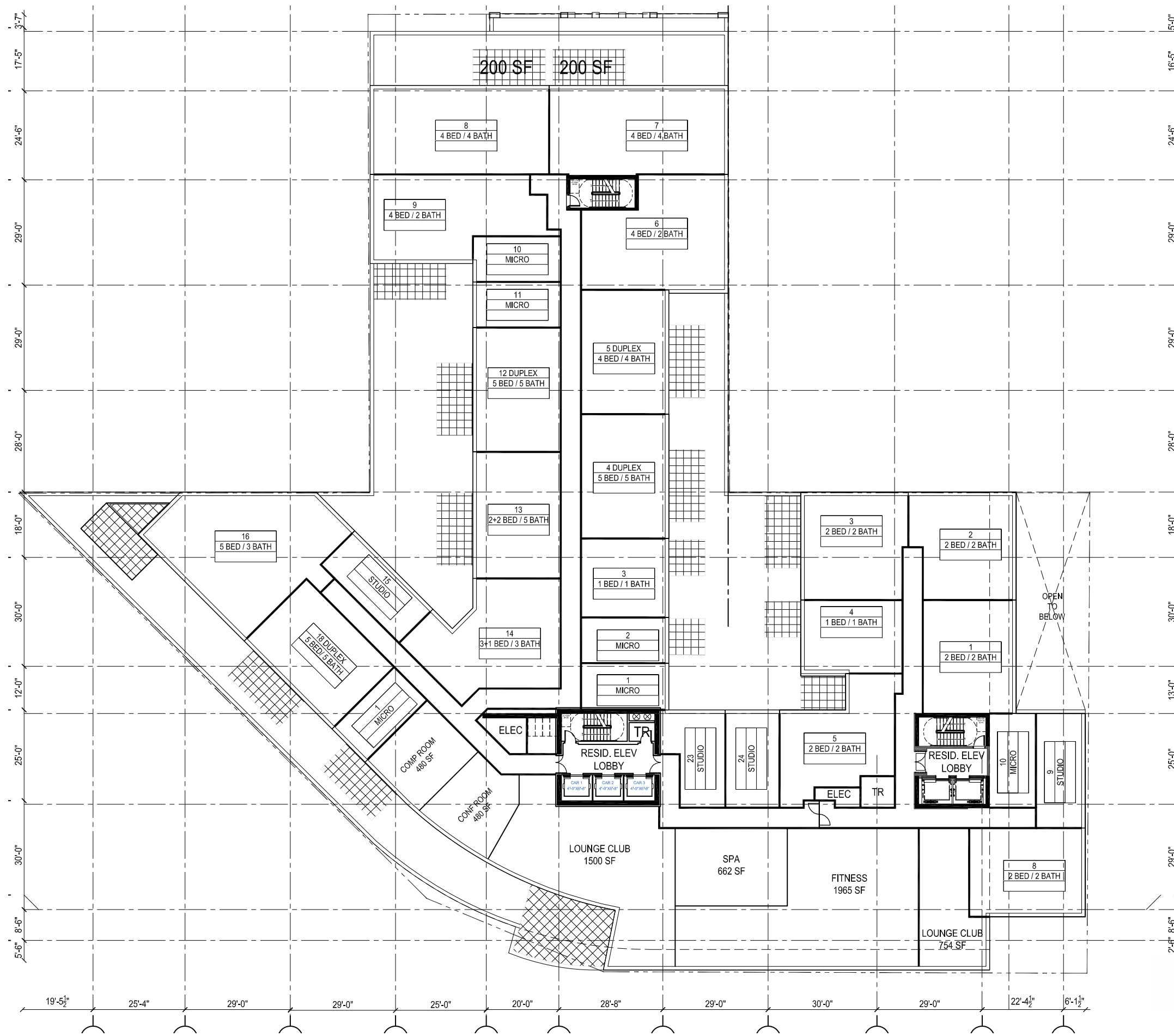

The Hub at Madison II - Conditional Use Application

Proposed Second Floor Plan

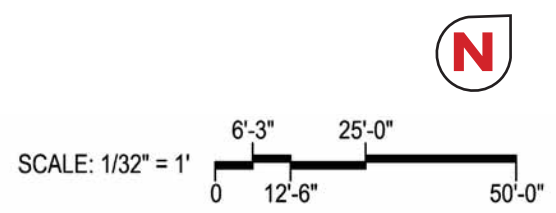

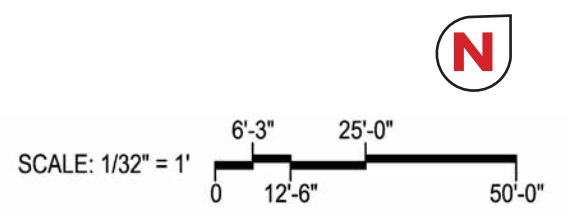
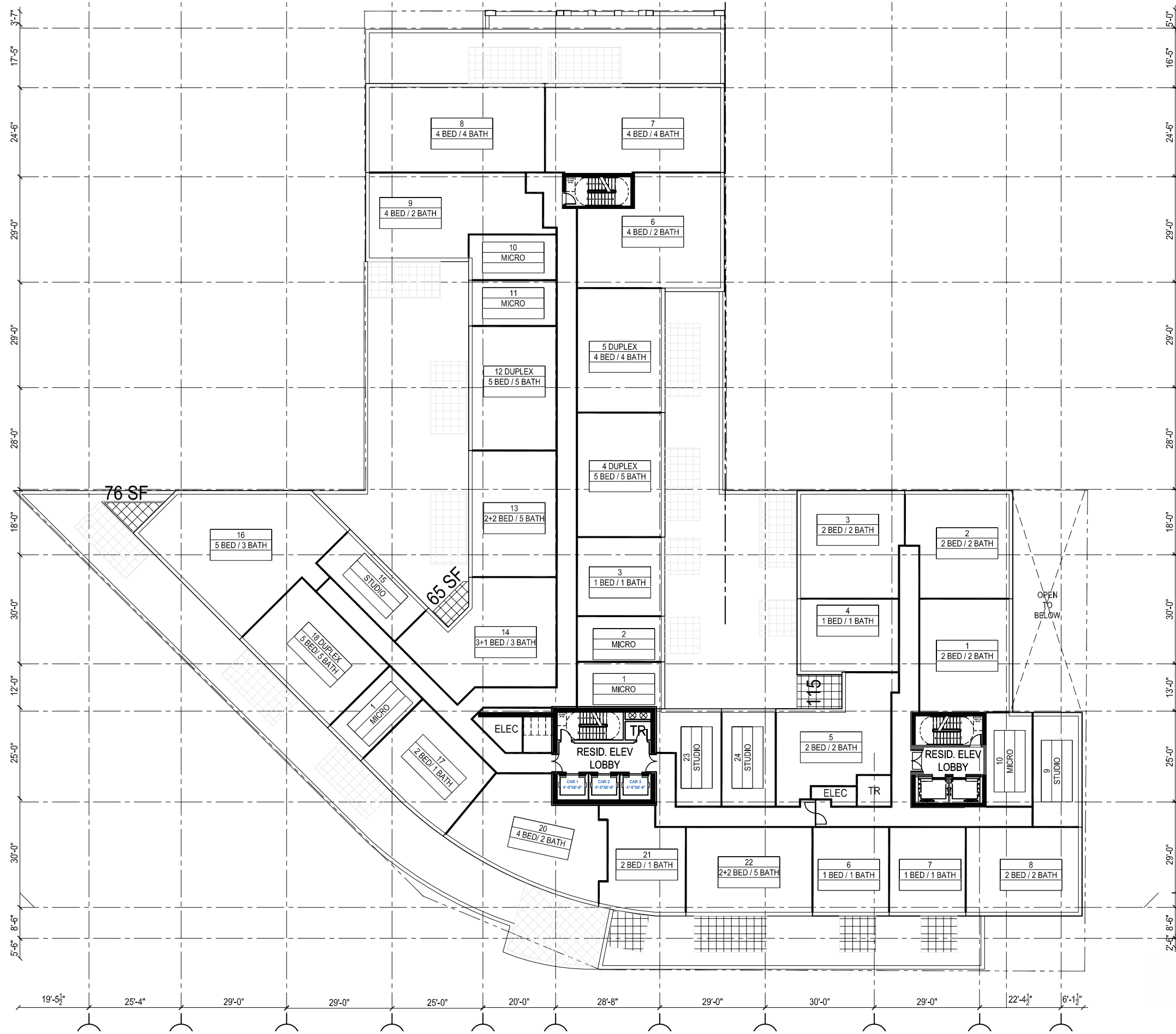

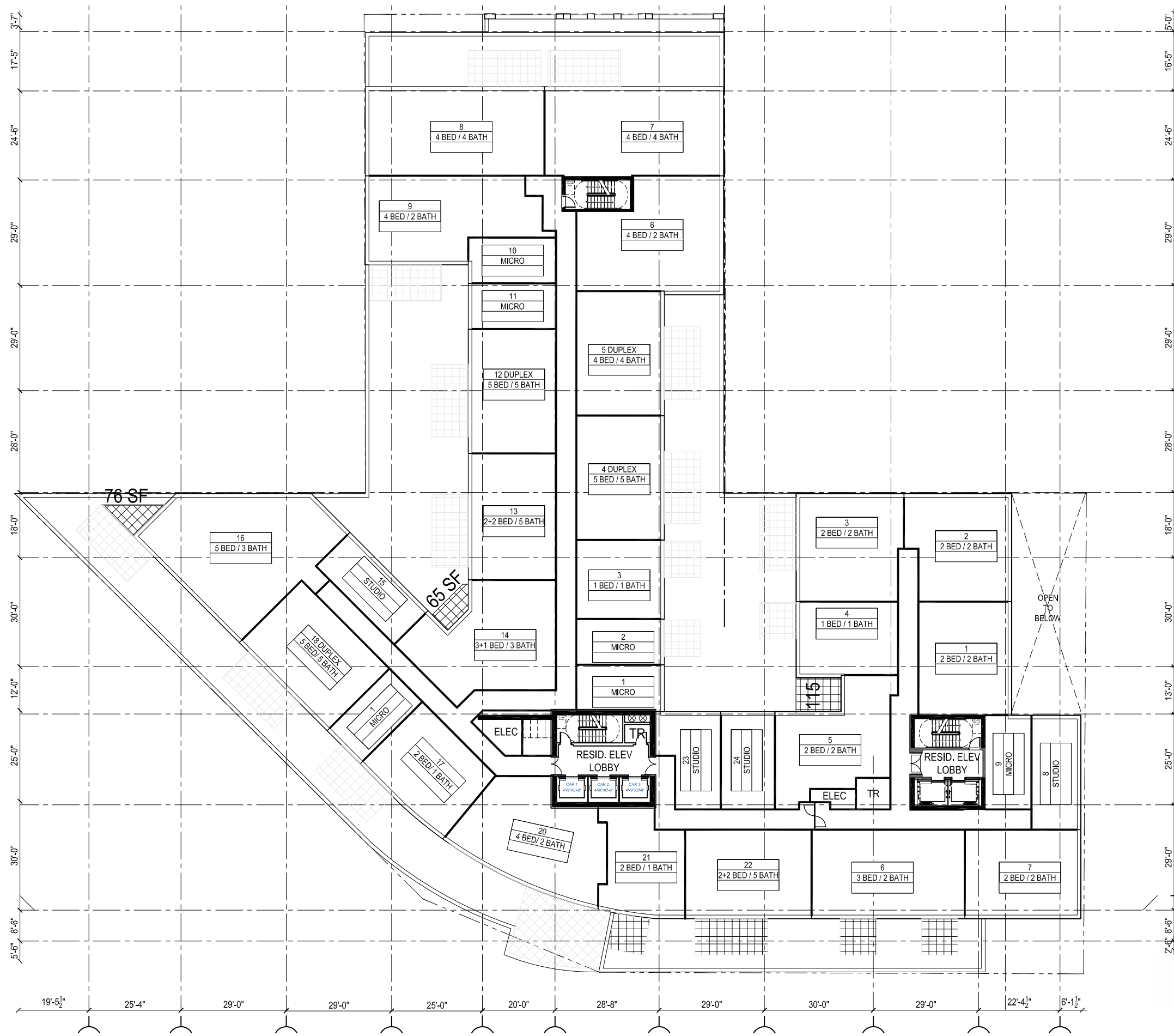

76 SF
65 SF

OPEN TO BELOW

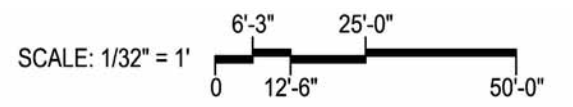

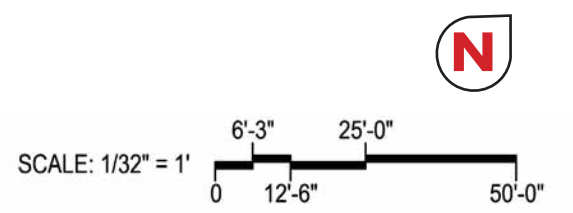
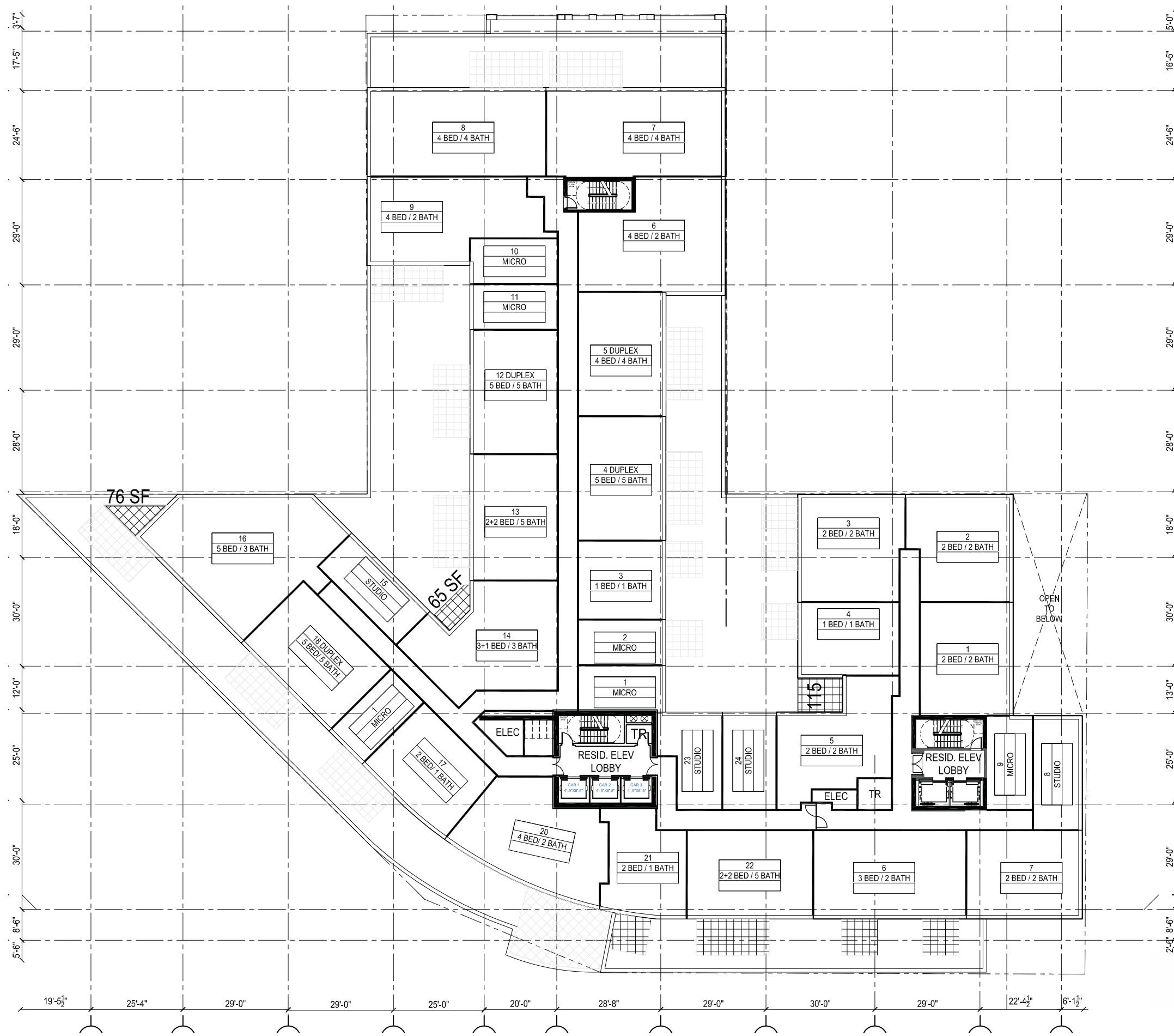

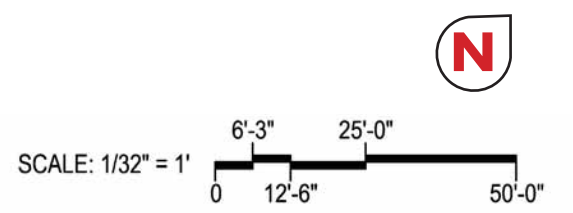
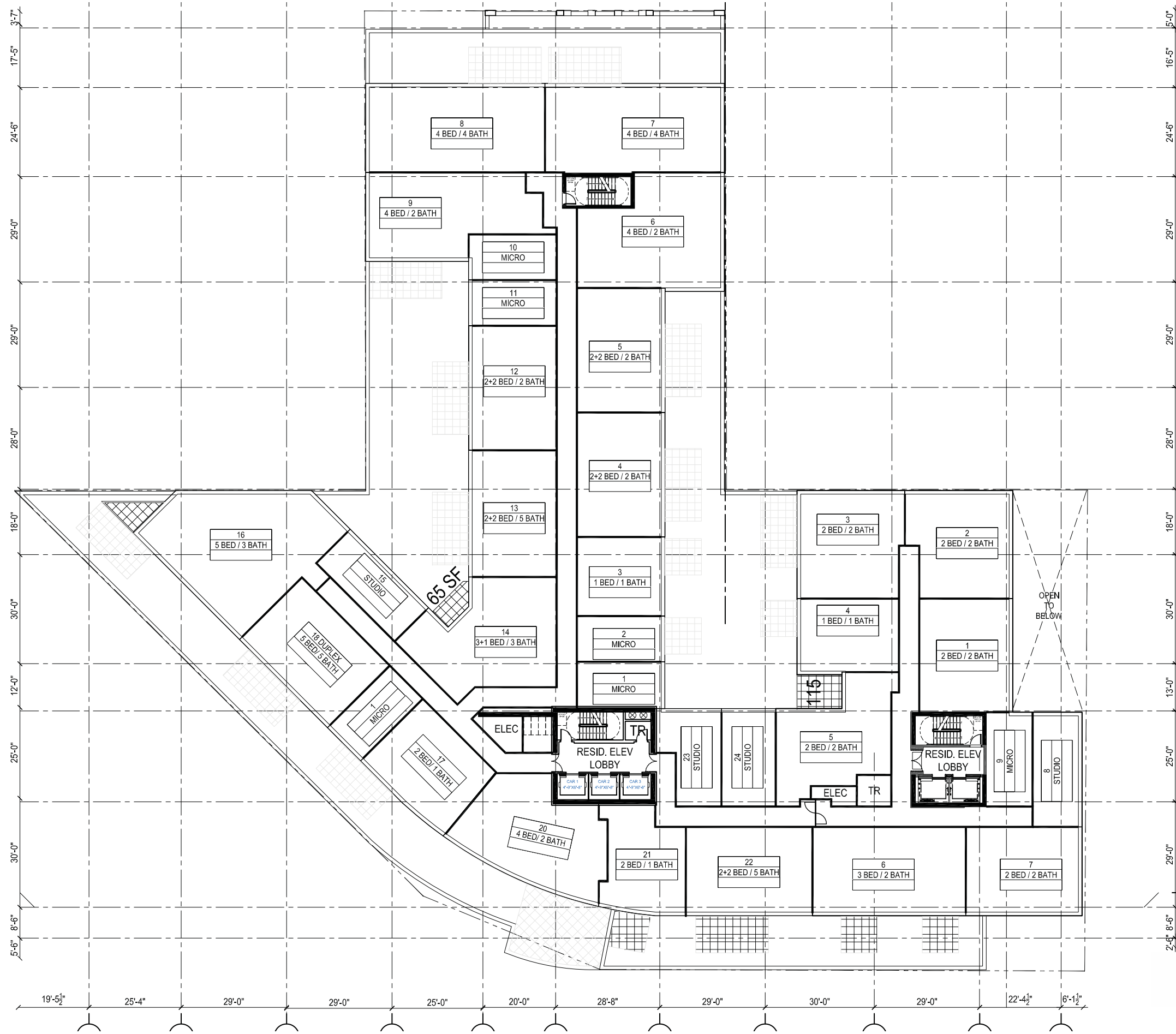

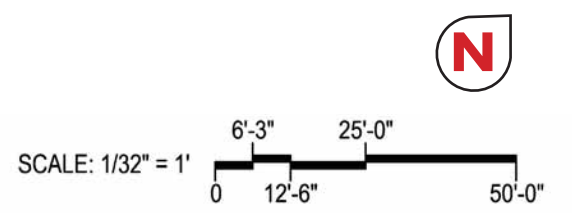
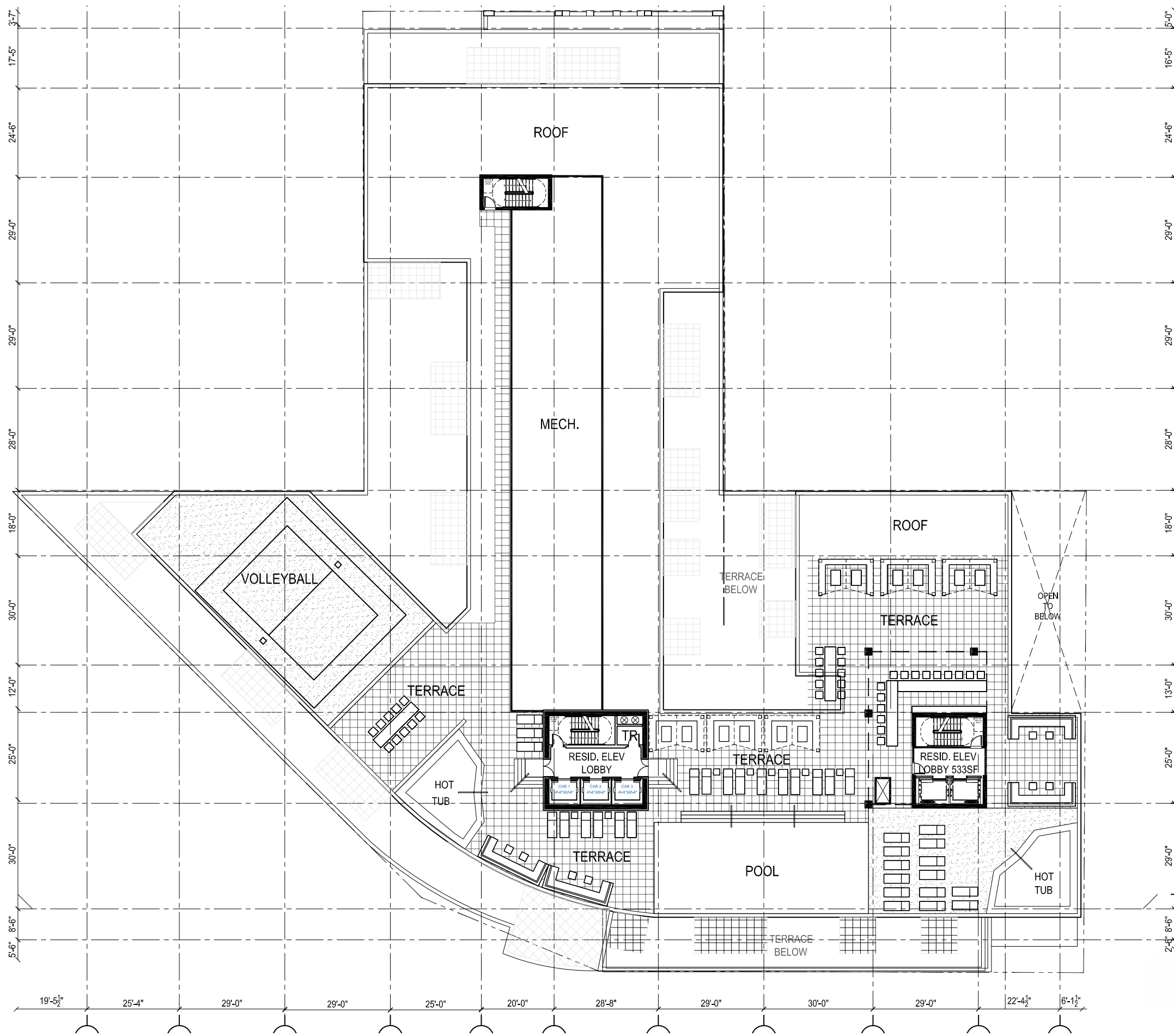

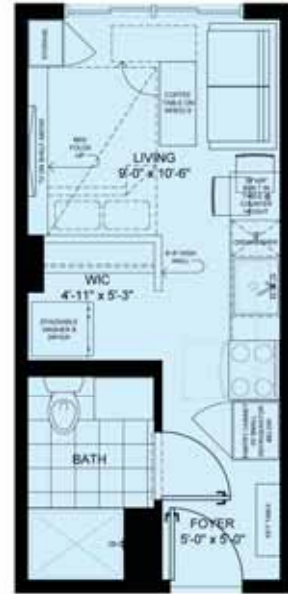

STUDIO



1 BED



2 BED

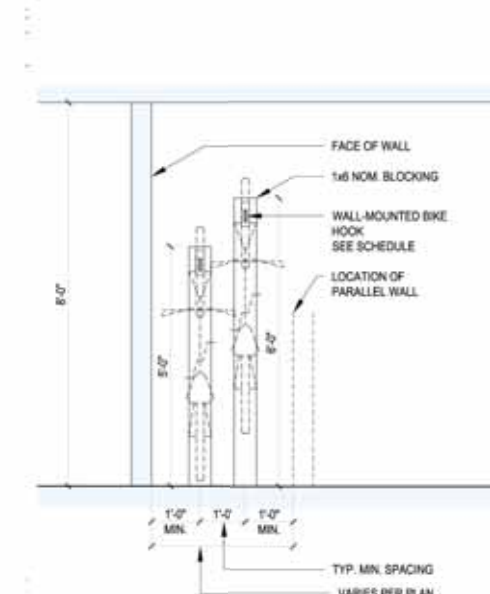

TYPICAL BICYCLE CLOSET ELEVATION



3 BED

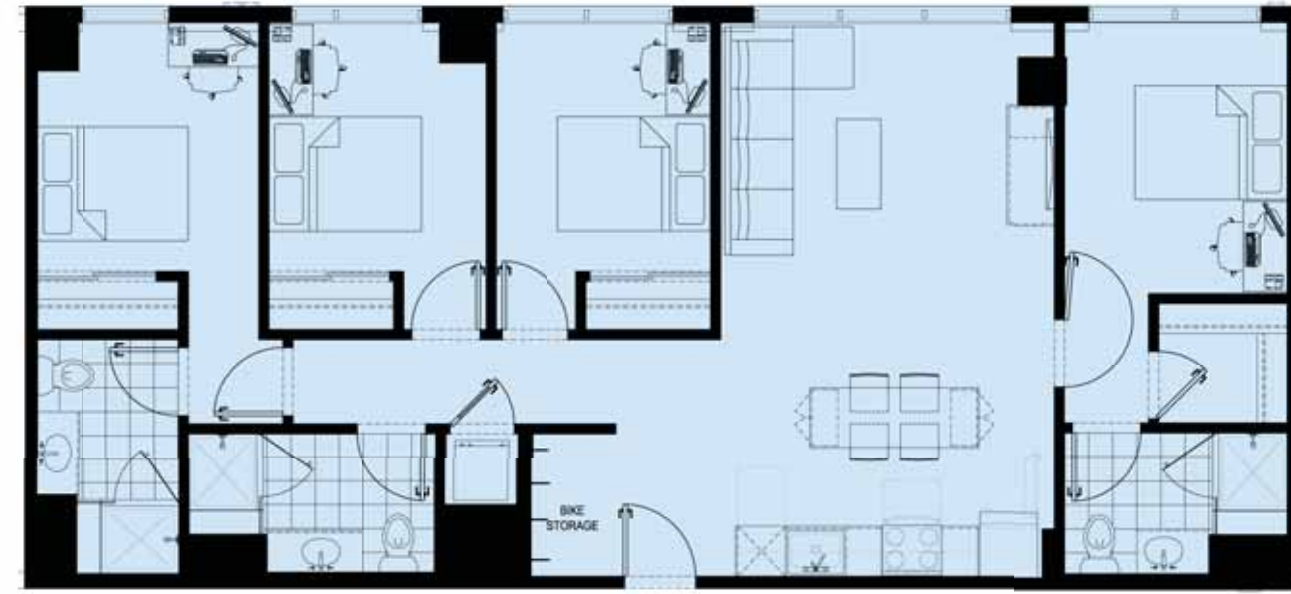

4 BED



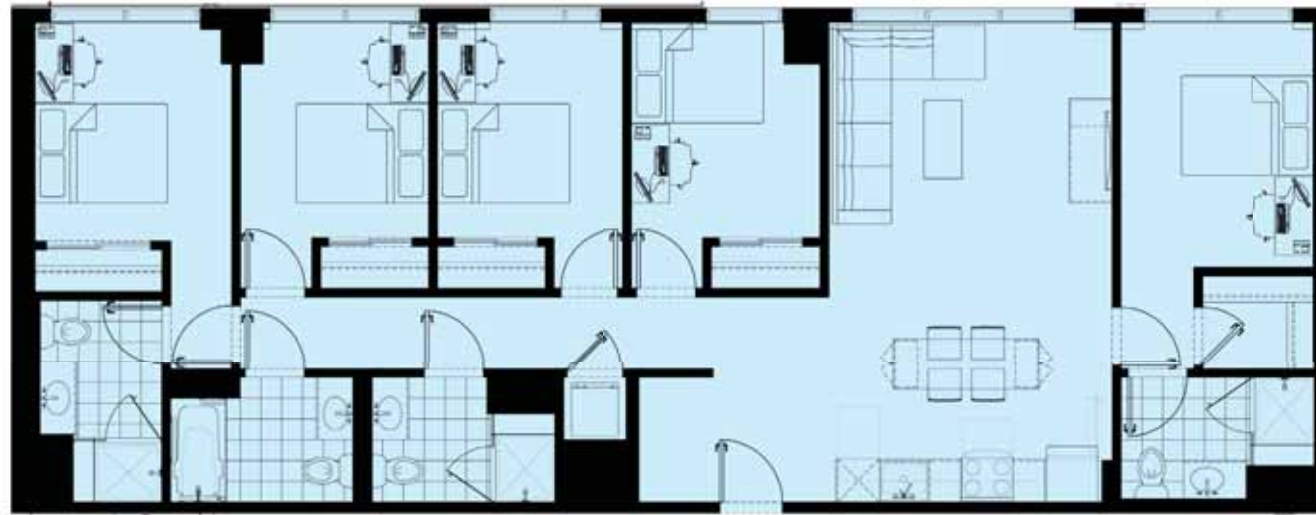

5 BED

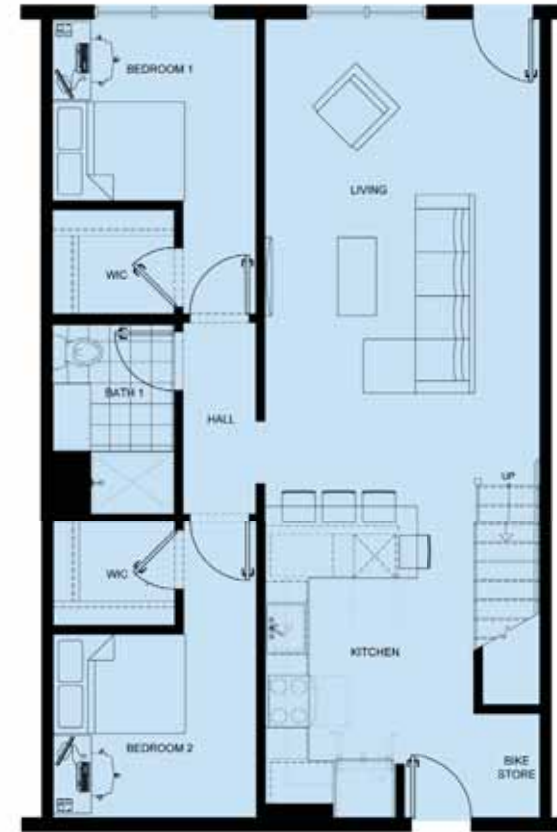

2nd FLOOR

5 BED TOWNHOME

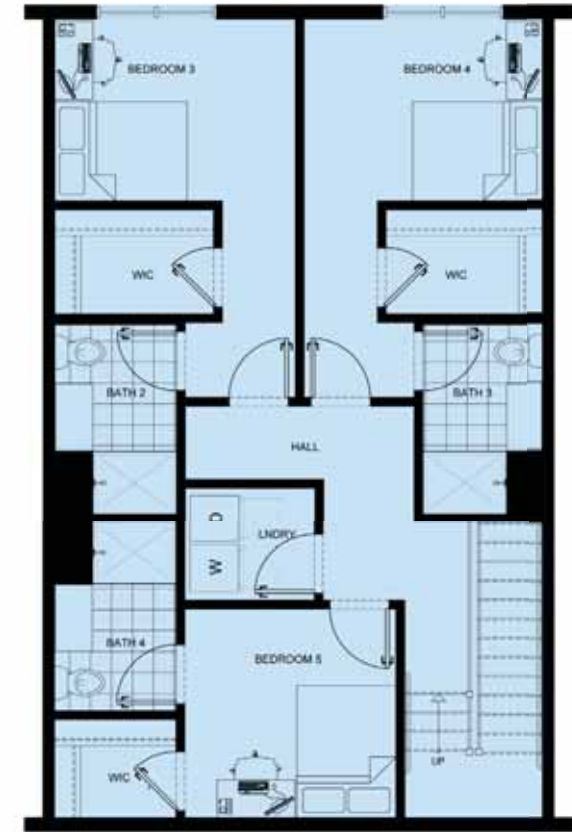

1st FLOOR

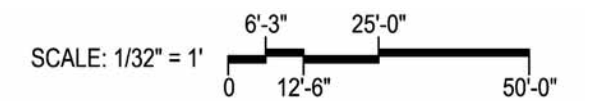

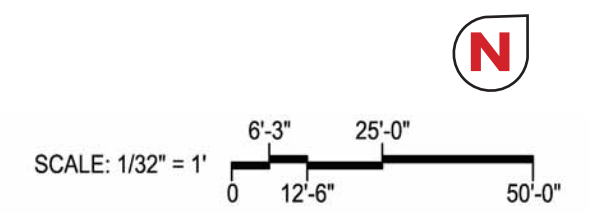
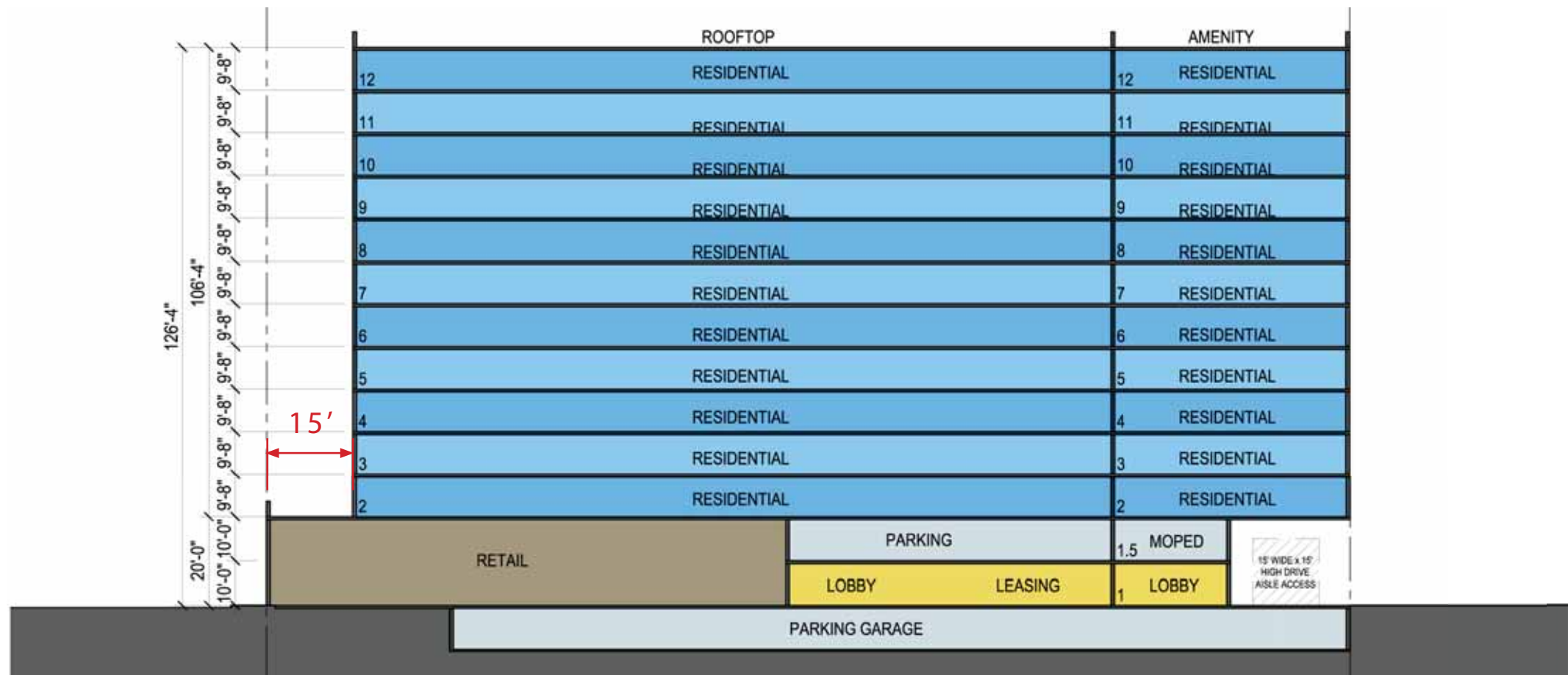
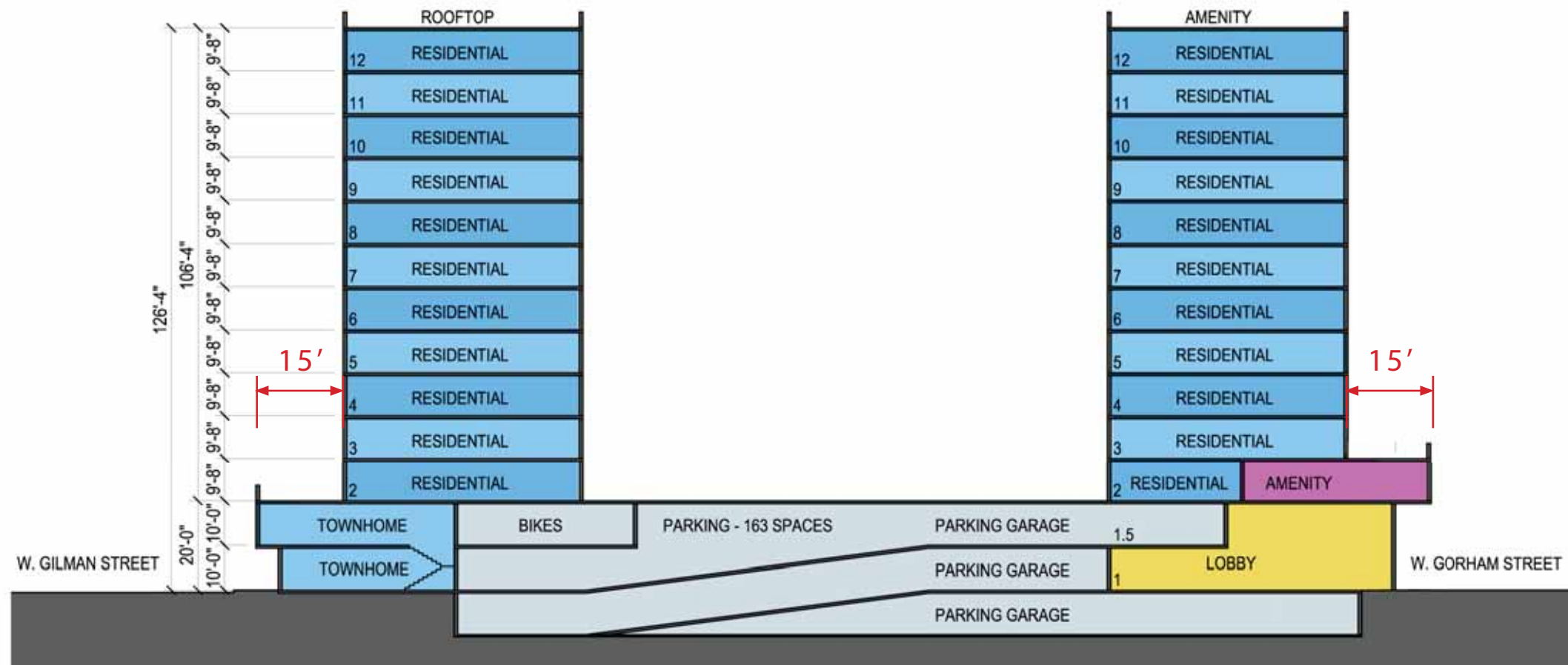

The Hub at Madison II- Area Analysis - 03/03/2015																								
SCHEME 1																								
FLOOR	Town Home			Student Residence					Young Professional					RETAIL AREA	Common			Parking				Building Total		
	UNITS	BEDS	AREA	ROOMS	BEDS	RENTABLE AREA	COMMON AREA	BALCONY/TERRACE AREA	ROOMS	BEDS	RENTABLE AREA	COMMON AREA	BALCONY/TERRACE AREA		LOADING	COMMON	MECH	PARKING AREA	SPACES	MOPED	BIKES	GROSS AREA	GROSS MINUS BALCONY/TERRACE AREA	F.A.R. AREA
13	-	-	-	-	-	-	1,078	10,138	-	-	-	533	5,070	-	-	-	3,439	-	-	-	20,258	5,050	1,611	
12	-	-	-	24	66	17,820	2,938	141	9	16	6,494	1,416	115	-	-	-	-	-	-	28,924	28,668	28,668		
11	-	-	-	20	50	17,536	2,938	141	9	16	6,494	1,416	115	-	-	-	-	-	-	28,640	28,384	28,384		
10	-	-	-	24	69	17,820	2,938	141	9	16	6,494	1,416	115	-	-	-	-	-	-	28,924	28,668	28,668		
9	-	-	-	20	50	17,536	2,938	141	10	15	6,494	1,416	115	-	-	-	-	-	-	28,640	28,384	28,384		
8	-	-	-	24	69	17,820	2,938	141	10	15	6,494	1,416	115	-	-	-	-	-	-	28,924	28,668	28,668		
7	-	-	-	20	50	17,536	2,938	141	10	15	6,494	1,416	115	-	-	-	-	-	-	28,640	28,384	28,384		
6	-	-	-	24	69	17,820	2,938	141	10	15	6,494	1,416	115	-	-	-	-	-	-	28,924	28,668	28,668		
5	-	-	-	20	50	17,536	2,938	141	10	15	6,494	1,416	115	-	-	-	-	-	-	28,640	28,384	28,384		
4	-	-	-	24	69	17,820	2,938	141	10	15	6,494	1,416	115	-	-	-	-	-	-	28,924	28,668	28,668		
3	-	-	-	20	50	17,536	2,938	441	10	15	6,494	1,416	315	-	-	-	-	-	-	29,140	28,384	28,384		
2	-	-	-	20	57	15,114	8,234	2,721	8	13	5,463	1,416	415	-	-	-	-	-	-	33,363	30,227	30,227		
1.5	-	-	3,399	0	0	0	862	0	0	0	0	510	0	-	-	-	20,091	46	34	76	24,862	24,862	4,771	
1	3	15	2,852	0	0	0	3,704	0	0	0	0	2,592	0	8,740	776	536	457	18,817	37	12	52	38,474	38,474	17,888
LL	-	-	-	0	0	0	860	0	0	0	0	487	0	-	-	-	1,116	34,031	79	9	181	36,494	36,494	0
TOTAL	3	15	6,251	240	649	191,894	44,118	14,569	105	166	70,403	19,698	6,835	8,740	776	536	5,012	72,939	162	55	309	441,771	420,367	339,757
Site Area (sf)				42,615.00																				
FAR				7.97																				

Unit Mix & Bed Analysis 3/3/2015																																														
Level	Market Rate										Student																	Totals																		
	Micro	Beds	Studio	Beds	1 Bed/1 Bath	Beds	2 Bed/2 Bath	Beds	3 Bed/2 Bath	Beds	Micro	Beds	Studio	Beds	1 Bed/1 Bath	Beds	2 Bed/1 Bath	Beds	2+2 Dbl/2 Bath	Beds	3 Bed/2 Bath	Beds	3+1 Bed/3 Bath	Beds	4 Bed/2 Bath	Beds	4 Bed/4 Bath	Beds	5 Bed/3 Bath	Beds	5 Bed/4 Bath	Beds	4/4 Duplex	Beds	5/5 Duplex	Beds	Town home	Beds	Total	Total						
Level 12	1	1	1	1	1	1	5	10	1	3	5	5	3	3	1	1	2	4	6	24	0	0	1	4	3	12	2	8	1	5	0	0	0	0	0	0	0	0	33	82						
Level 11	1	1	1	1	1	1	5	10	1	3	5	5	3	3	1	1	2	4	2	8	0	0	1	4	3	12	2	8	1	5	0	0	0	0	0	0	0	0	29	66						
Level 10	1	1	1	1	1	1	5	10	1	3	5	5	3	3	1	1	2	4	2	8	0	0	1	4	3	12	2	8	1	5	0	0	0	1	4	3	15	33	85							
Level 9	1	1	1	1	3	3	5	10	0	0	5	5	3	3	1	1	2	4	2	8	0	0	1	4	3	12	2	8	1	5	0	0	0	0	0	0	0	0	30	65						
Level 8	1	1	1	1	3	3	5	10	0	0	5	5	3	3	1	1	2	4	2	8	0	0	1	4	3	12	2	8	1	5	0	0	1	4	3	15	34	84								
Level 7	1	1	1	1	3	3	5	10	0	0	5	5	3	3	1	1	2	4	2	8	0	0	1	4	3	12	2	8	1	5	0	0	0	0	0	0	0	30	65							
Level 6	1	1	1	1	3	3	5	10	0	0	5	5	3	3	1	1	2	4	2	8	0	0	1	4	3	12	2	8	1	5	0	0	1	4	3	15	34	84								
Level 5	1	1	1	1	3	3	5	10	0	0	5	5	3	3	1	1	2	4	2	8	0	0	1	4	3	12	2	8	1	5	0	0	0	0	0	0	0	30	65							
Level 4	1	1	1	1	3	3	5	10	0	0	5	5	3	3	1	1	2	4	2	8	0	0	1	4	3	12	2	8	1	5	0	0	1	4	3	15	34	84								
Level 3	1	1	1	1	3	3	5	10	0	0	5	5	3	3	1	1	2	4	2	8	0	0	1	4	3	12	2	8	1	5	0	0	0	0	0	0	0	30	65							
Level 2	1	1	1	1	1	1	5	10	0	0	5	5	3	3	1	1	0	0	1	4	0	0	1	4	2	8	2	8	1	5	0	0	1	4	3	15	28	70								
Level 1.5		0		0		0		0		0		0		0		0		0		0		0		0		0		0		0		0		0		0	3	15	3	15						
Total Mix	11	11	11	11	25	25	55	110	3	9	55	55	33	33	11	11	20	40	25	100	0	0	11	44	32	128	22	88	11	55	0	0	5	20	15	75	3	15	348	830						
Percentages	10%		10%		24%		52%			3%		23%		14%		5%		8%		10%		0%		5%		13%		9%		5%		0%		2%		6%		1%								
Total	Units 105		Beds 166																			Units 243		Beds 664																						
Project Total	Units 348		Beds 830																																											
Percentages	3%		3%		7%		1%			16%		9%		3%		6%		7%		0%		3%		9%		6%		3%		0%		1%		4%		0%		100%								
Target Goal	%																																										340		838	

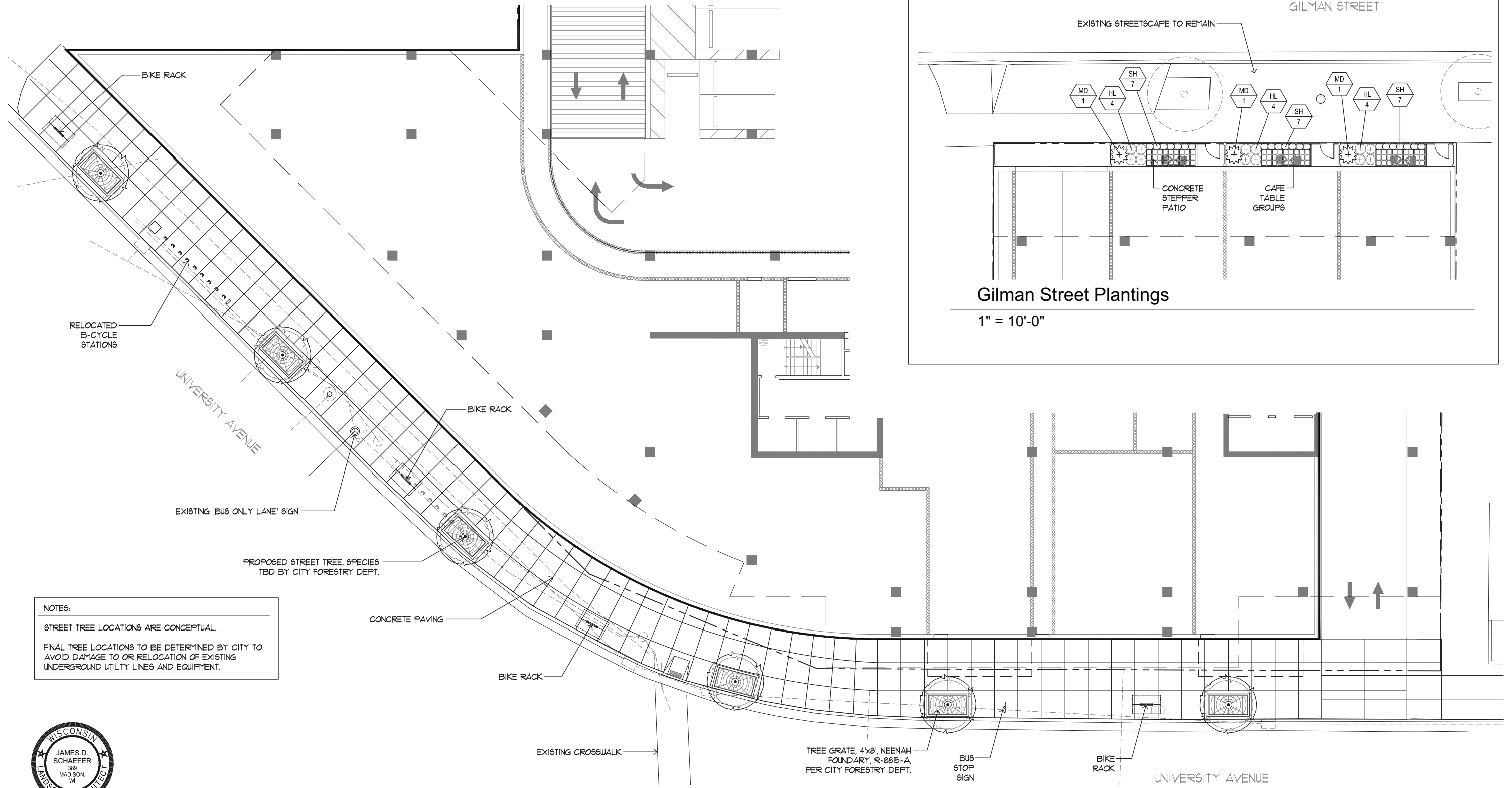

NOTES:
 STREET TREE LOCATIONS ARE CONCEPTUAL.
 FINAL TREE LOCATIONS TO BE DETERMINED BY CITY TO AVOID DAMAGE TO OR RELOCATION OF EXISTING UNDERGROUND UTILITY LINES AND EQUIPMENT.



University Avenue Streetscape

1" = 10'-0"



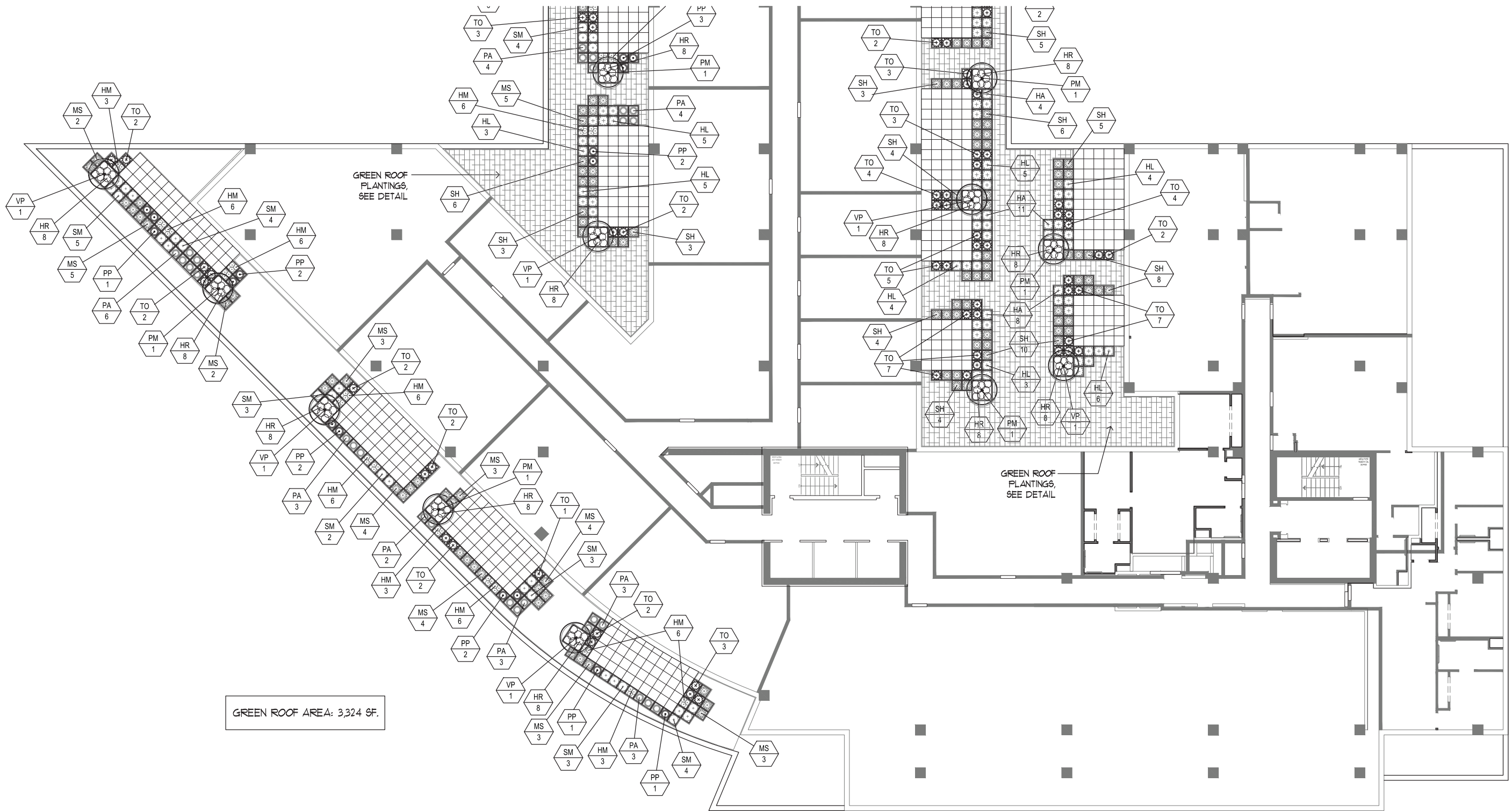

2nd Floor, South

1" = 10'-0"



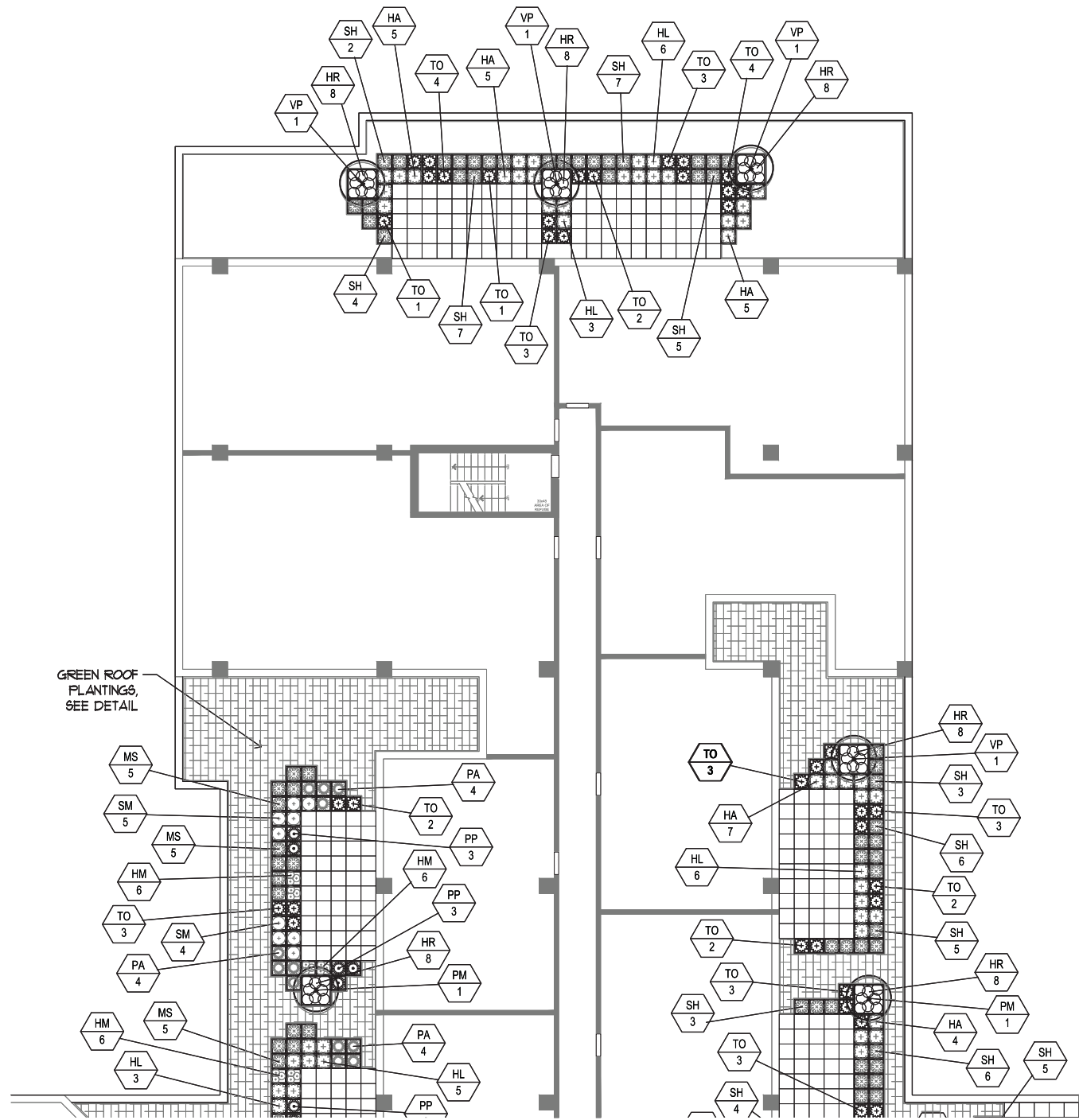

2nd Floor, North

1" = 10'-0"

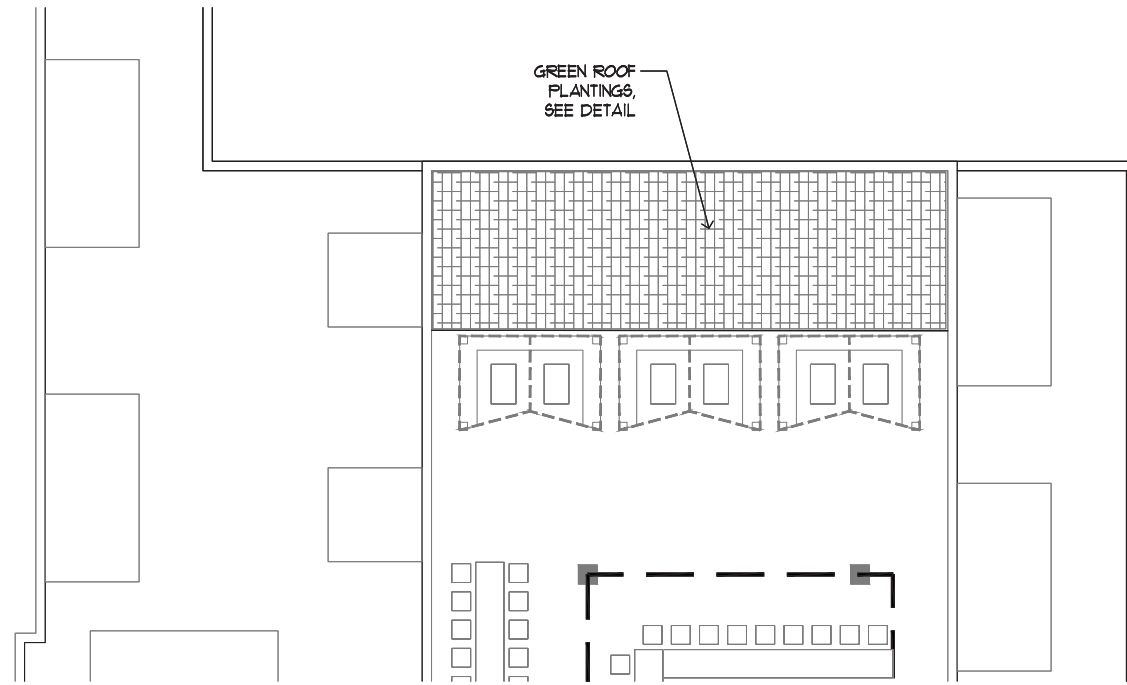

Roof Level

1" = 10'-0"

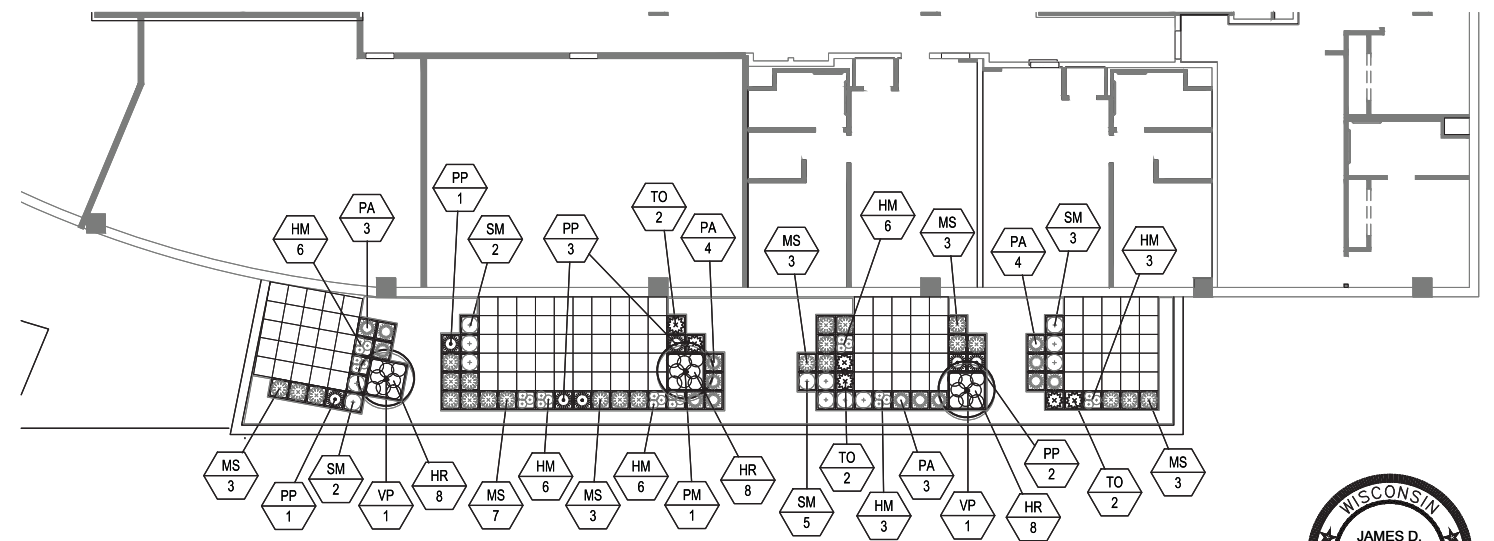

3rd Floor

1" = 10'-0"



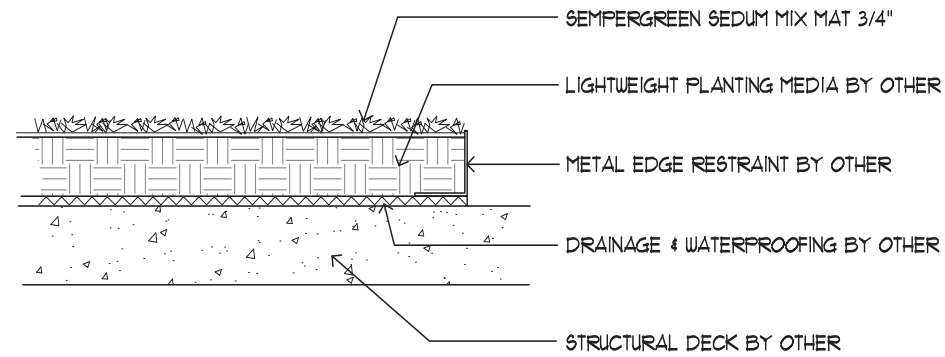

Green Roof Plantings

1/2" = 1'-0"

Plant Schedule

Street Trees						
SYM.	BOTANICAL NAME	COMMON NAME	QTY.	SIZE	COND.	SPACING
	TBD by City Forestry		6	3" cal.	B/B	In Grates
Ornamental Trees						
SYM.	BOTANICAL NAME	COMMON NAME	QTY.	SIZE	COND.	SPACING
PM	Prunus maackii	Amur Chokecherry	7	8' Ht. Multi	B/B	As shown
VP	Viburnum prunifolium	Blackhaw Viburnum	12	6' Ht. Multi	B/B	As shown
Shrubs						
SYM.	BOTANICAL NAME	COMMON NAME	QTY.	SIZE	COND.	SPACING
MD	Microbiota decussata	Siberian Cypress	3	2 Gal.	Container	60" o.c.
PP	Picea pungens 'Globosa'	Dwarf Globe Blue Spruce	24	24" Ht.	B/B	As shown
TO	Thuja occidentalis 'Little Giant'	Little Giant Arborvitae	92	48" Ht.	B/B	48" o.c.
Perennials						
SYM.	BOTANICAL NAME	COMMON NAME	QTY.	SIZE	COND.	SPACING
HA	Hosta 'August Moon'	August Moon Hosta	45	1 Gal.	Container	30" o.c.
HL	Hosta 'Love Pat'	Love Pat Hosta	62	1 Gal.	Container	30" o.c.
HM	Heuchera macrantha 'Palace Purple'	Coral Bells 'Palace Purple'	93	1 Gal.	Container	18" o.c.
HR	Hemerocallis 'Rosy Returns'	Pink Daylily	152	1 Gal.	Container	18" o.c.
MS	Miscanthus sinensis 'Red Flame'	Red Flame Miscanthus	70	1 Gal.	Container	30" o.c.
PA	Pennisetum alopecuroides 'Hamlen'	Hamlen Dwarf Fountain Grass	46	1 Gal.	Container	18" o.c.
SM	Salvia x 'May Night'	May Night Salvia	45	1 Gal.	Container	18" o.c.
SH	Sporobolus heterolepis	Prairie Dropseed	126	1 Gal.	Container	18" o.c.



James D. Schaefer





Amur Chokecherry (PM)
Prunus maackii 8' Ht. Multi



Blackhaw Viburnum (VP)
Viburnum prunifolium 6' Ht. Multi



Siberian Cypress (MD)
Mircobiota decussata 2 Gal.



Dwarf Globe Blue Spruce (PP)
Picea pungens 'Globosa' 24" Ht.



Little Giant Arborvitae (TO)
Thuja occidentalis 'Little Giant' 48" Ht.



August Moon Hosta (HA)
Hosta 'August Moon' 1 Gal.



Love Pat Hosta (HL)
Hosta 'Love Pat' 1 Gal.



Coral Bells 'Palace Purple' (HM)
Heuchera macrantha 'Palace Purple' 1



Pink Daylily (HR)
Hemerocallis 'Rosy Returns' 1 Gal.



Red Flame Miscanthus (MS)
Miscanthus sinensis 'Red Flame' 1 Gal.



Hamlen Dwarf Fountain Grass (PA)
Pennisetum alopecuroides 'Hamlen' 1 Gal.





May Night Salvia (SM)
Salvia x 'May Night' 1 Gal.



Prairie Dropseed (SH)
Sporobolus heterolepis 1 Gal.

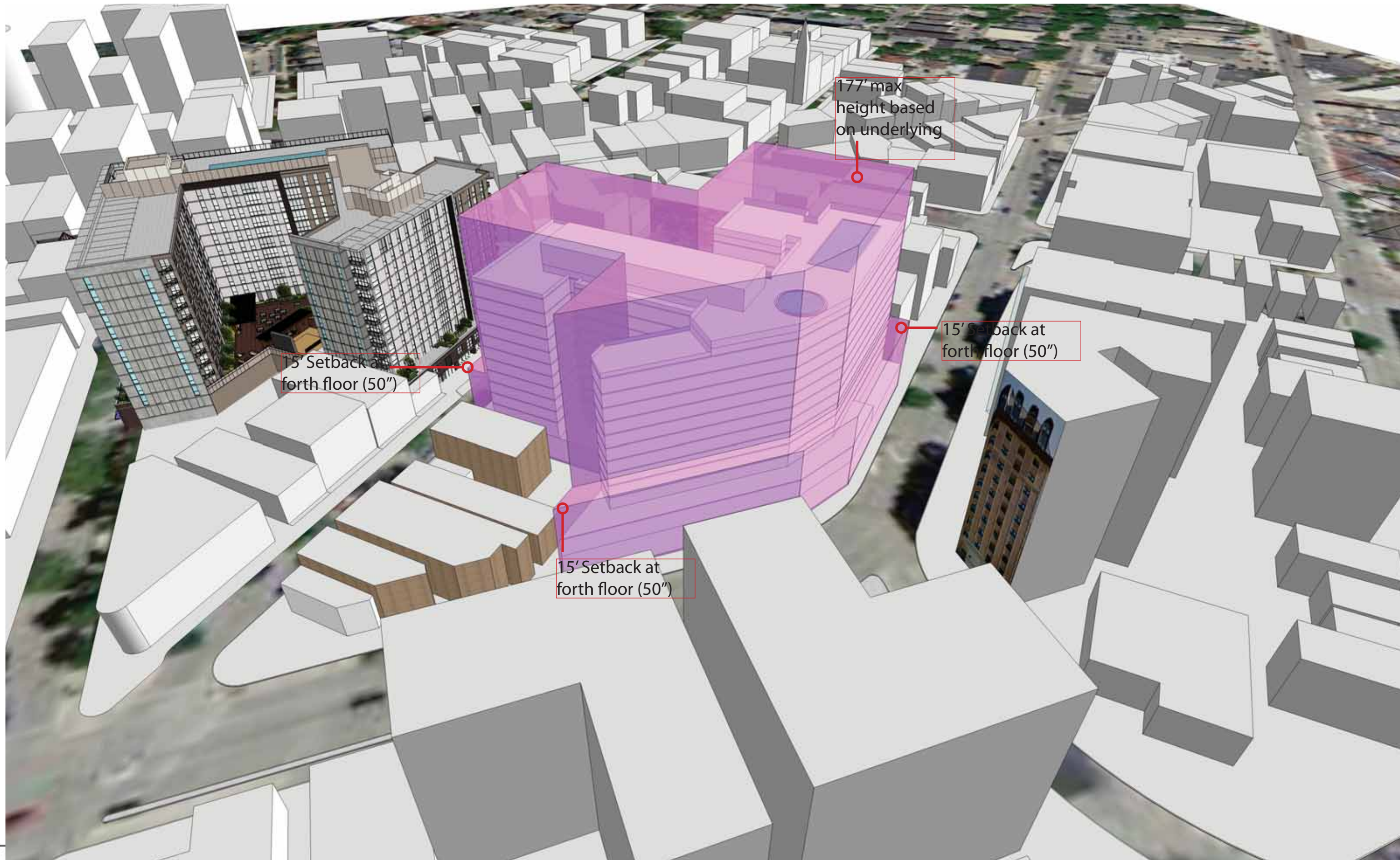

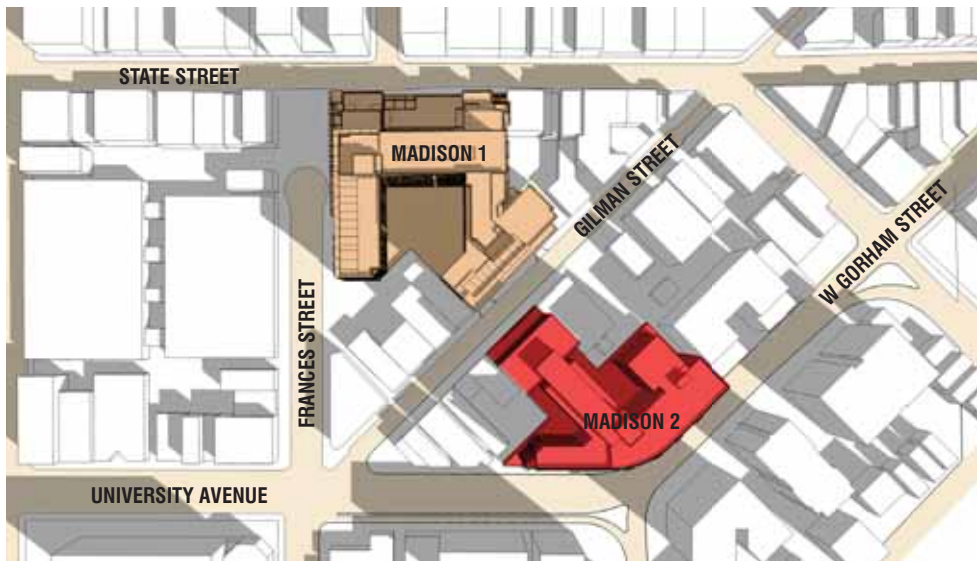

March 20 - 9:30 am

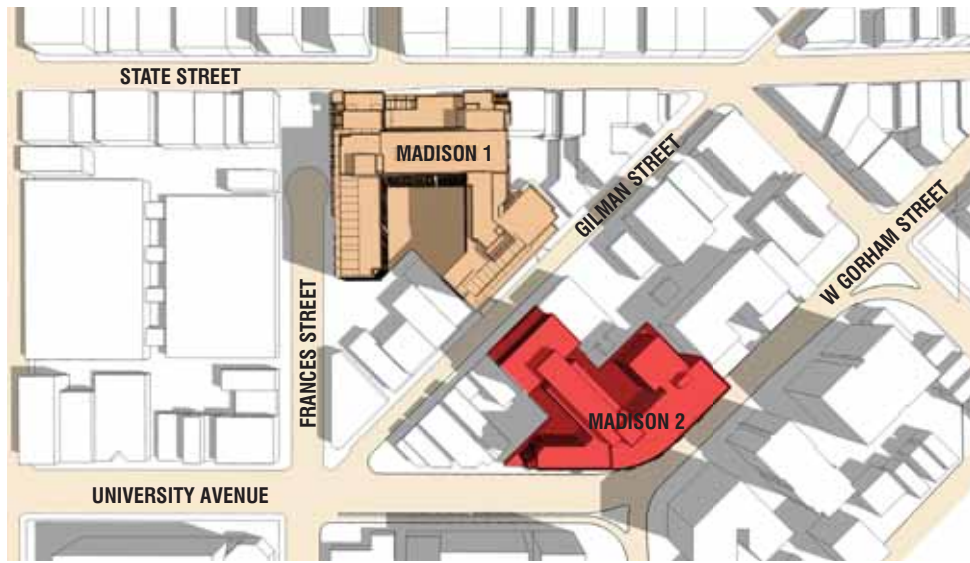

June 21 - 9:30 am

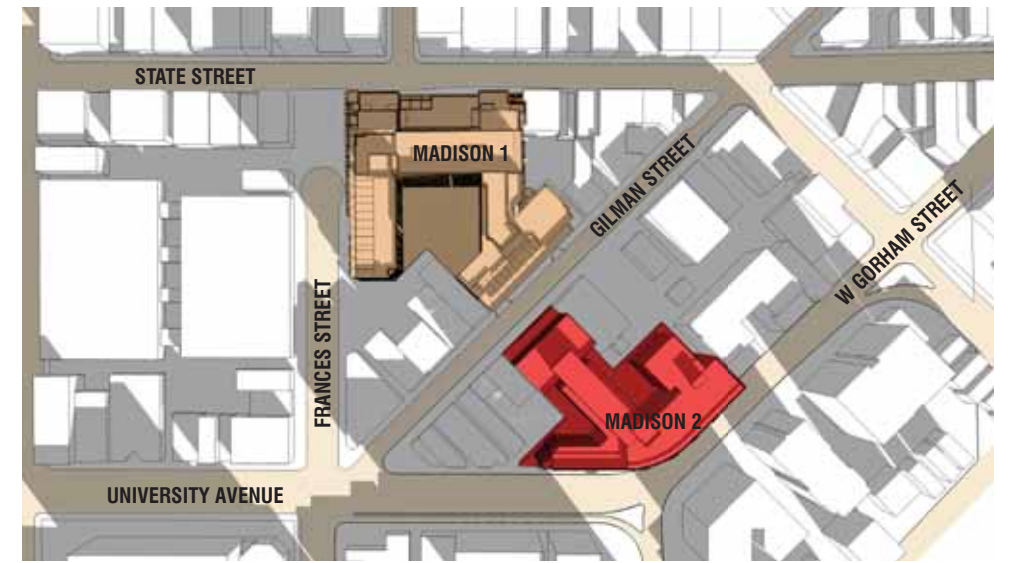

December 21 - 9:30 am

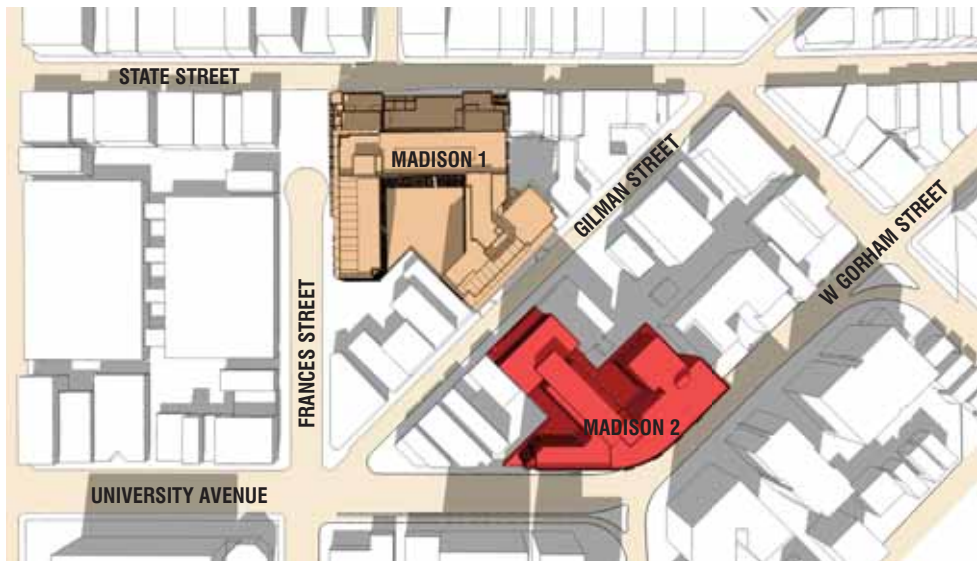

March 20 - 12:30 pm

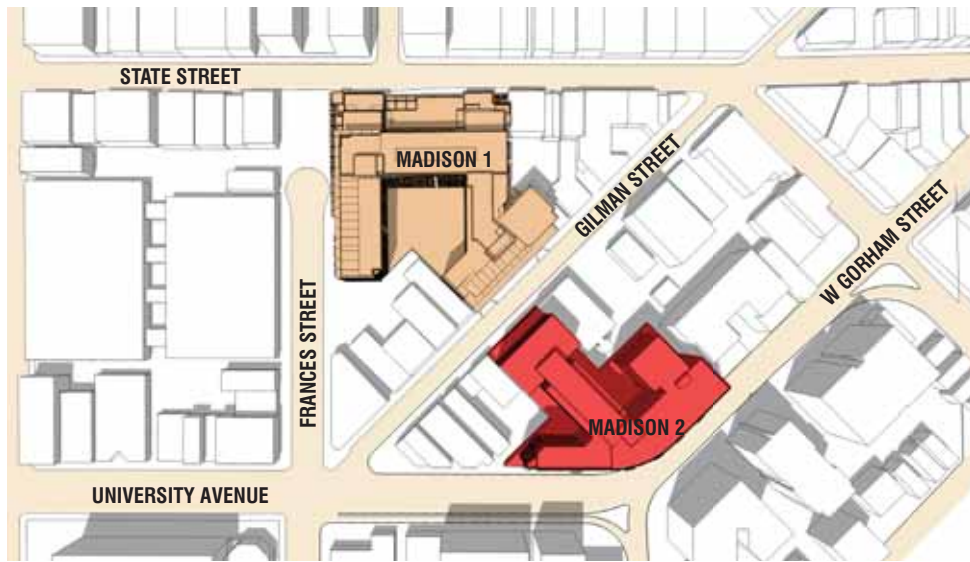

June 21 - 12:30 pm

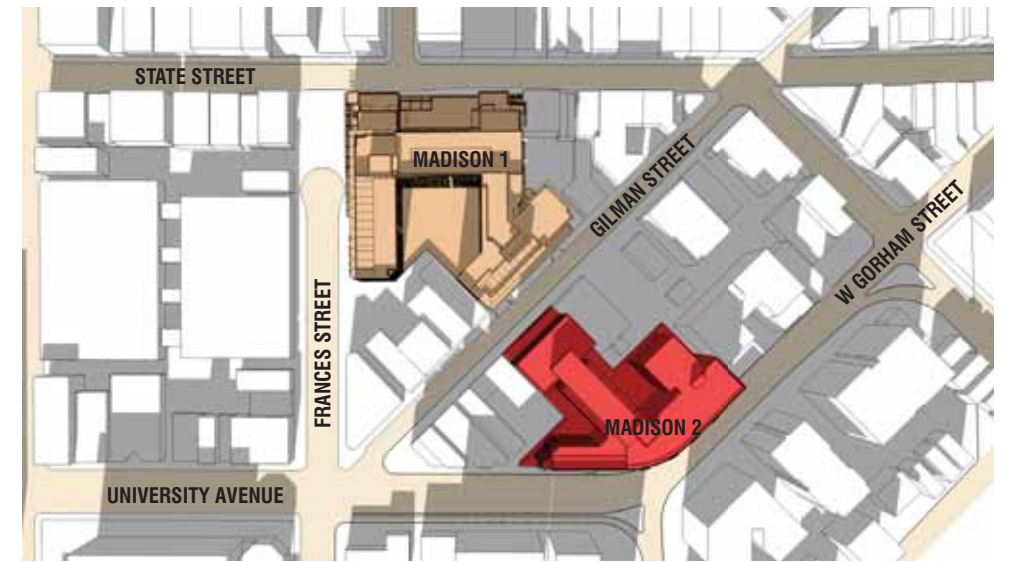

December 21 - 12:30 pm

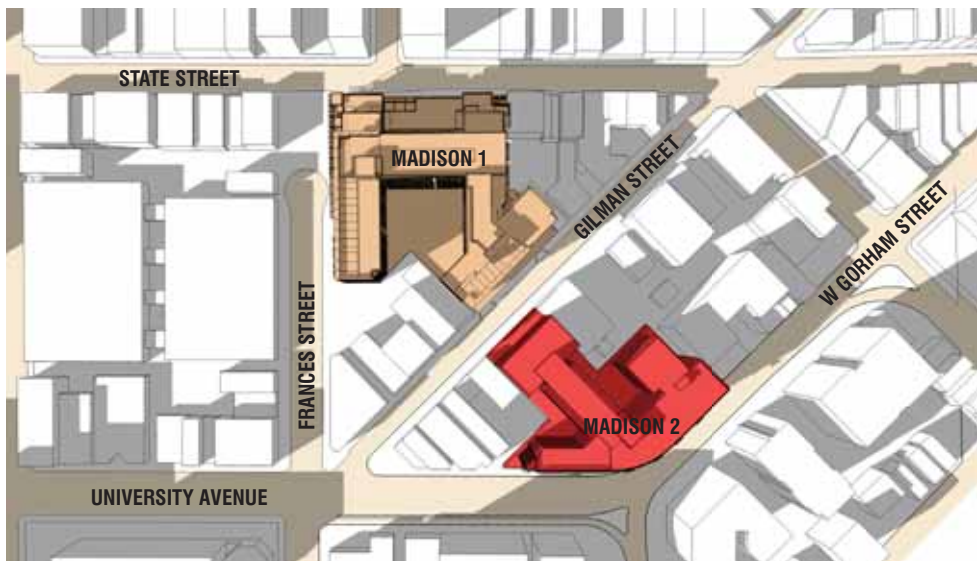

March 20 - 3:30 pm

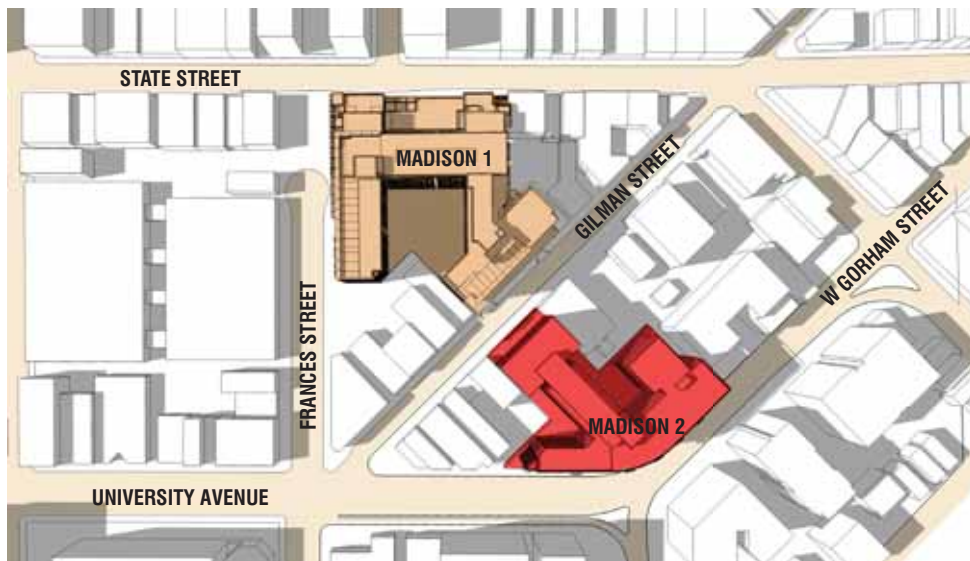

June 21 - 3:30 pm

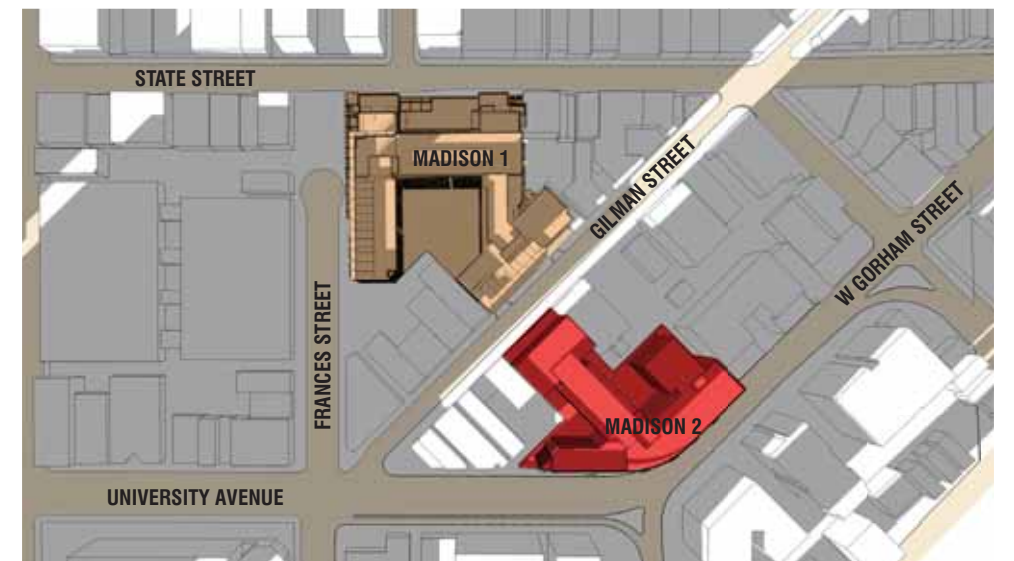

December 21 - 3:30 pm



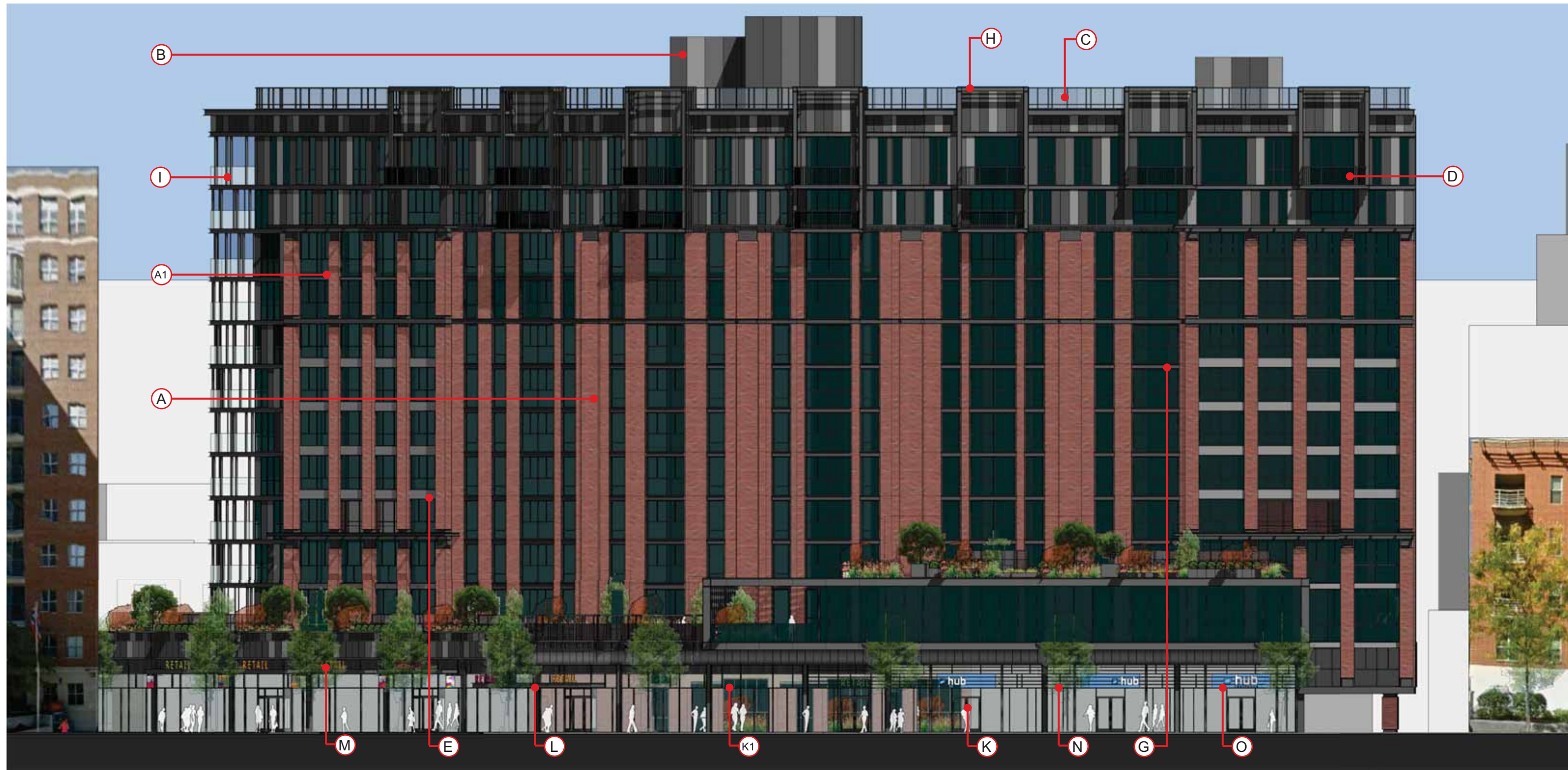

Exterior Material Legend

- | | | | |
|---|--|---|---|
| <ul style="list-style-type: none"> A Utility Brick A1 Brick Columns with Metal Channel Detailing B Metal Panel/Stucco Panel System, 3 tone C Roof Top Terrace Screen, Glass in Fill | <ul style="list-style-type: none"> D Metal Balustrades E Light Grey Metal Panel F Aluminum Cladding System G Metal Channel H Metal Frame and Louver Frame at Balconies I Glass Balustrades | <ul style="list-style-type: none"> J Aluminum Thermopane Operable Window System with Clear Anodized Aluminum Finish K Aluminum Thermopane Storefront Window System and Doors with Clear Anodized Aluminum Finish K1 Store Front Windows are Subject to Change Based Upon Individual Tenants Designs at Time of Leasing, To be Approved | <ul style="list-style-type: none"> L Black Steel Canopy M Illuminated Signage (By Tennant at Retail with separate approval) N Louved Screen at Entries O Colored Glass Canopy P Painted Concrete/CMU Pattern Podium Wall |
|---|--|---|---|





Exterior Material Legend

- | | | | |
|---|--|---|---|
| <ul style="list-style-type: none"> A Utility Brick A1 Brick Columns with Metal Channel Detailing B Metal Panel/Stucco Panel System, 3 tone C Roof Top Terrace Screen, Glass in Fill | <ul style="list-style-type: none"> D Metal Balustrades E Light Grey Metal Panel F Aluminum Cladding System G Metal Channel H Metal Frame and Louver Frame at Balconies I Glass Balustrades | <ul style="list-style-type: none"> J Aluminum Thermopane Operable Window System with Clear Anodized Aluminum Finish K Aluminum Thermopane Storefront Window System and Doors with Clear Anodized Aluminum Finish K1 Store Front Windows are Subject to Change Based Upon Individual Tenants Designs at Time of Leasing, To be Approved | <ul style="list-style-type: none"> L Black Steel Canopy M Illuminated Signage (By Tennant at Retail with separate approval) N Louved Screen at Entries O Colored Glass Canopy P Painted Concrete/CMU Pattern Podium Wall |
|---|--|---|---|





Exterior Material Legend

- | | | | |
|---|--|---|---|
| <ul style="list-style-type: none"> A Utility Brick A1 Brick Columns with Metal Channel Detailing B Metal Panel/Stucco Panel System, 3 tone C Roof Top Terrace Screen, Glass in Fill | <ul style="list-style-type: none"> D Metal Balustrades E Light Grey Metal Panel F Aluminum Cladding System G Metal Channel H Metal Frame and Louver Frame at Balconies I Glass Balustrades | <ul style="list-style-type: none"> J Aluminum Thermopane Operable Window System with Clear Anodized Aluminum Finish K Aluminum Thermopane Storefront Window System and Doors with Clear Anodized Aluminum Finish K1 Store Front Windows are Subject to Change Based Upon Individual Tenants Designs at Time of Leasing, To be Approved | <ul style="list-style-type: none"> L Black Steel Canopy M Illuminated Signage (By Tennant at Retail with separate approval) N Louved Screen at Entries O Colored Glass Canopy P Painted Concrete/CMU Pattern Podium Wall |
|---|--|---|---|



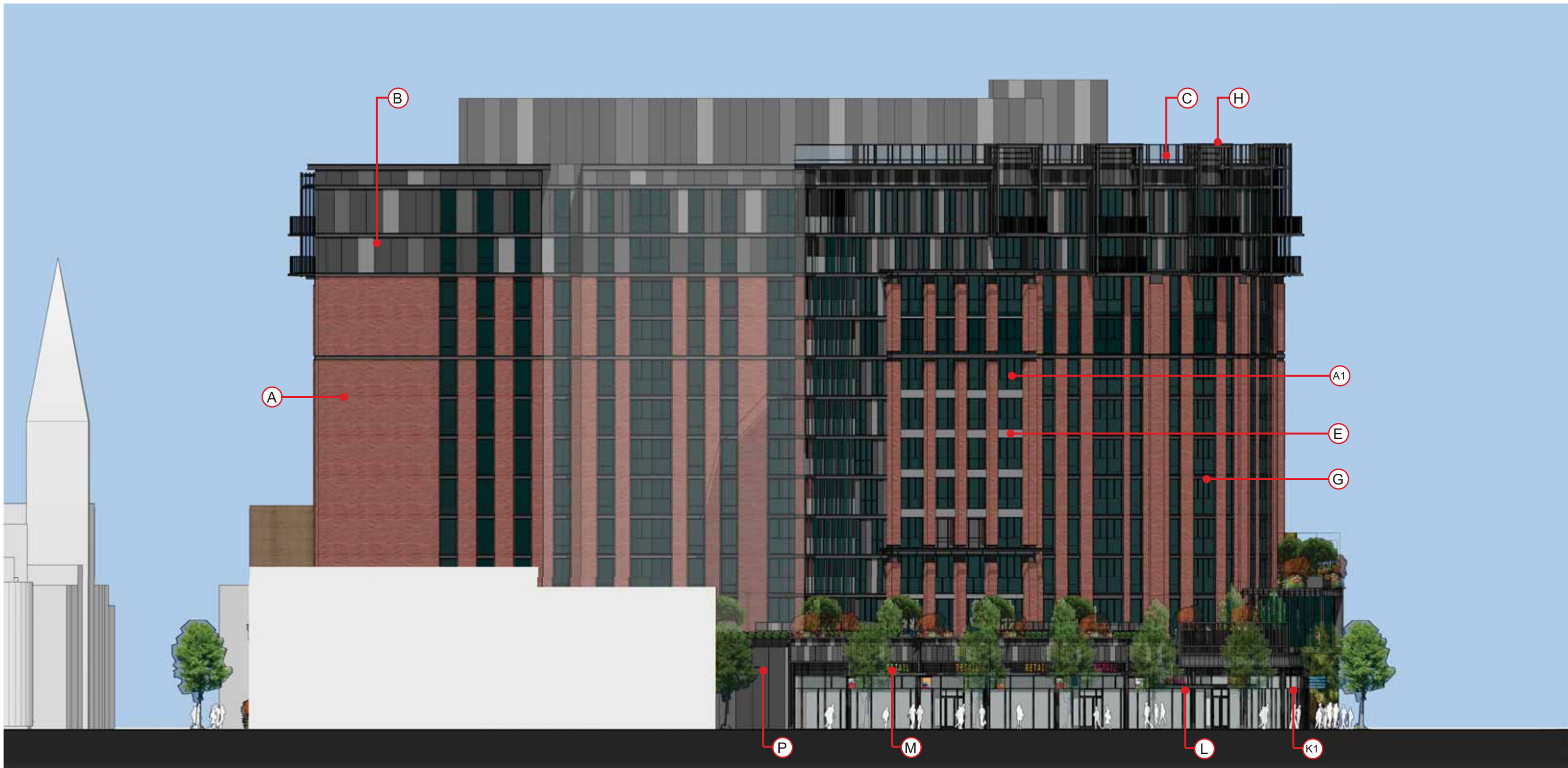

Exterior Material Legend

- | | | | |
|---|--|---|---|
| <ul style="list-style-type: none"> A Utility Brick A1 Brick Columns with Metal Channel Detailing B Metal Panel/Stucco Panel System, 3 tone C Roof Top Terrace Screen, Glass in Fill | <ul style="list-style-type: none"> D Metal Balustrades E Light Grey Metal Panel F Aluminum Cladding System G Metal Channel H Metal Frame and Louver Frame at Balconies I Glass Balustrades | <ul style="list-style-type: none"> J Aluminum Thermopane Operable Window System with Clear Anodized Aluminum Finish K Aluminum Thermopane Storefront Window System and Doors with Clear Anodized Aluminum Finish K1 Store Front Windows are Subject to Change Based Upon Individual Tenants Designs at Time of Leasing, To be Approved | <ul style="list-style-type: none"> L Black Steel Canopy M Illuminated Signage (By Tennant at Retail with separate approval) N Louved Screen at Entries O Colored Glass Canopy P Painted Concrete/CMU Pattern Podium Wall |
|---|--|---|---|





Exterior Material Legend

- | | | | |
|---|--|---|---|
| <ul style="list-style-type: none"> A Utility Brick A1 Brick Columns with Metal Channel Detailing B Metal Panel/Stucco Panel System, 3 tone C Roof Top Terrace Screen, Glass in Fill | <ul style="list-style-type: none"> D Metal Balustrades E Light Grey Metal Panel F Aluminum Cladding System G Metal Channel H Metal Frame and Louver Frame at Balconies I Glass Balustrades | <ul style="list-style-type: none"> J Aluminum Thermopane Operable Window System with Clear Anodized Aluminum Finish K Aluminum Thermopane Storefront Window System and Doors with Clear Anodized Aluminum Finish K1 Store Front Windows are Subject to Change Based Upon Individual Tenants Designs at Time of Leasing, To be Approved | <ul style="list-style-type: none"> L Black Steel Canopy M Illuminated Signage (By Tennant at Retail with separate approval) N Louved Screen at Entries O Colored Glass Canopy P Painted Concrete/CMU Pattern Podium Wall |
|---|--|---|---|



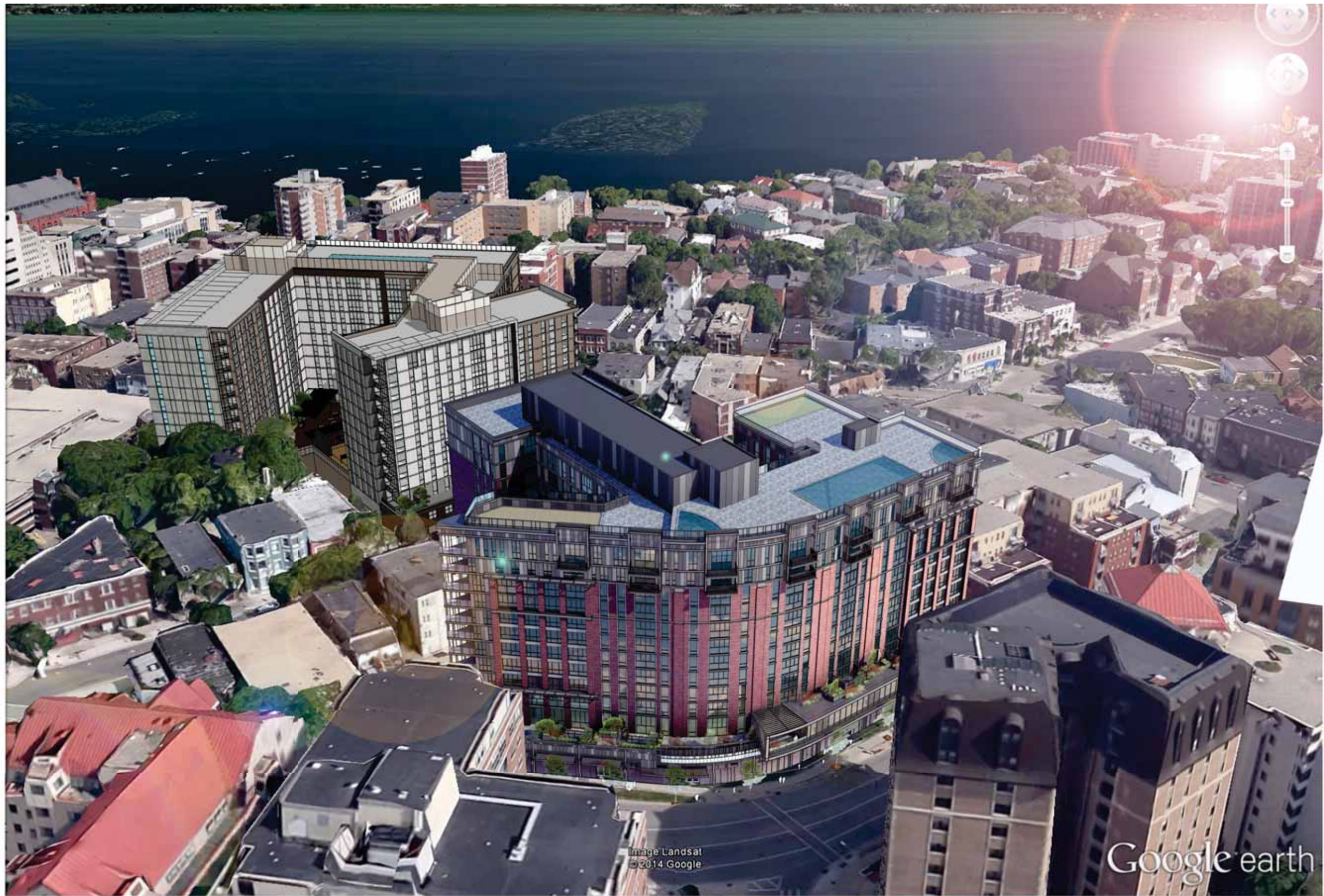

The Hub at Madison II - Conditional Use Application

Core Campus Developers | Antunovich Associates Architecture · Planning

Proposed Aerial View 1

Madison, Wisconsin | February 24, 2015



The Hub at Madison II - Conditional Use Application

Core Campus Developers | Antunovich Associates Architecture · Planning

Proposed Aerial View 2

Madison, Wisconsin | February 24, 2015



The Hub at Madison II - Conditional Use Application

Core Campus Developers | Antunovich Associates Architecture · Planning

Proposed View East on University Ave

Madison, Wisconsin | February 24, 2015



The Hub at Madison II - Conditional Use Application

Core Campus Developers | Antunovich Associates Architecture · Planning

Proposed View North on Basset Street

Madison, Wisconsin | February 24, 2015



The Hub at Madison II - Conditional Use Application

Core Campus Developers | Antunovich Associates Architecture · Planning

Proposed View West on Gorham Street

Madison, Wisconsin | February 24, 2015

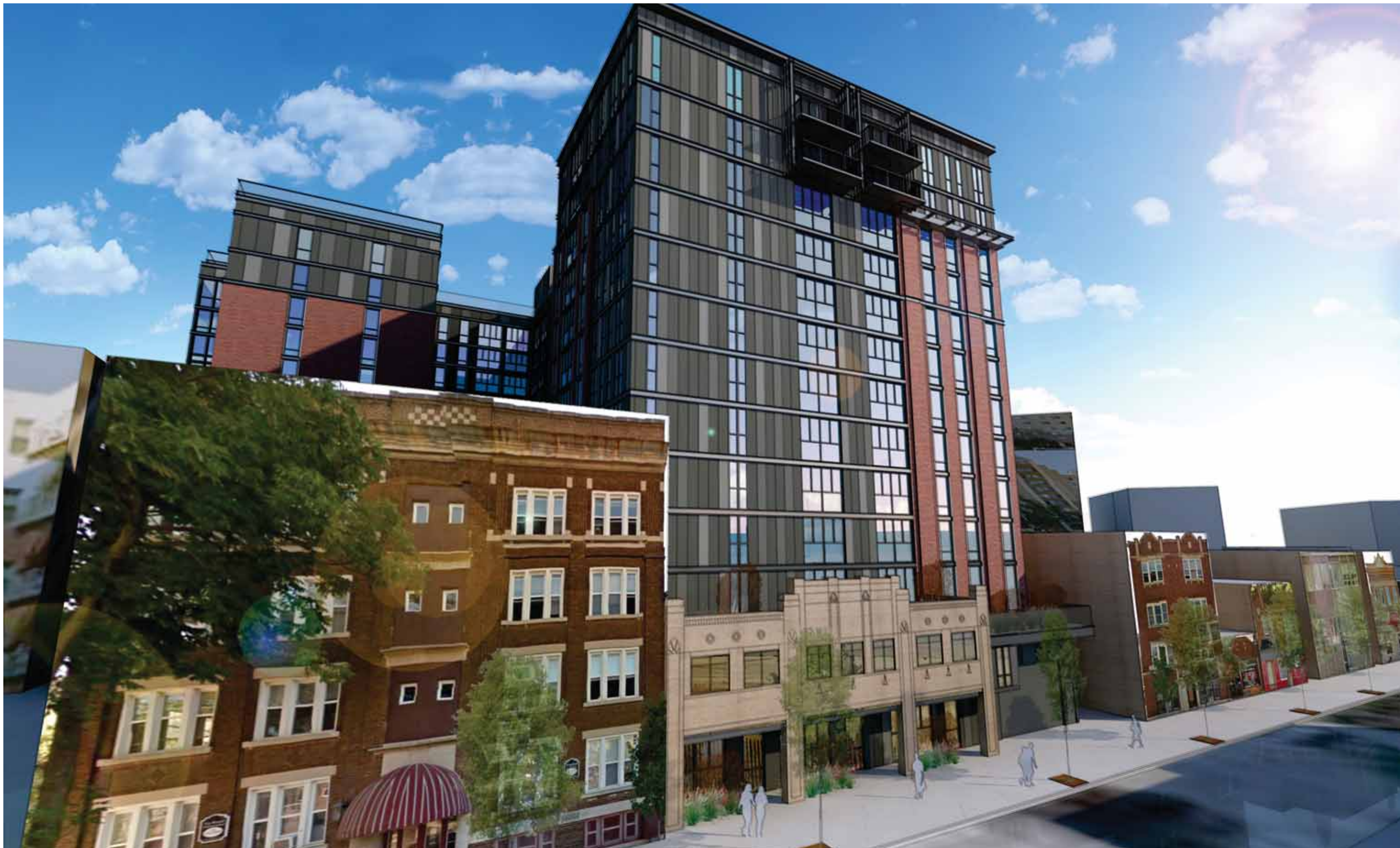

The Hub at Madison II - Conditional Use Application

Core Campus Developers | Antunovich Associates Architecture · Planning

Proposed View South West on Gilman Street

Madison, Wisconsin | February 24, 2015



The Hub at Madison II - Conditional Use Application

Core Campus Developers | Antunovich Associates Architecture · Planning

Proposed View North East on Gilman Street

Madison, Wisconsin | February 24, 2015



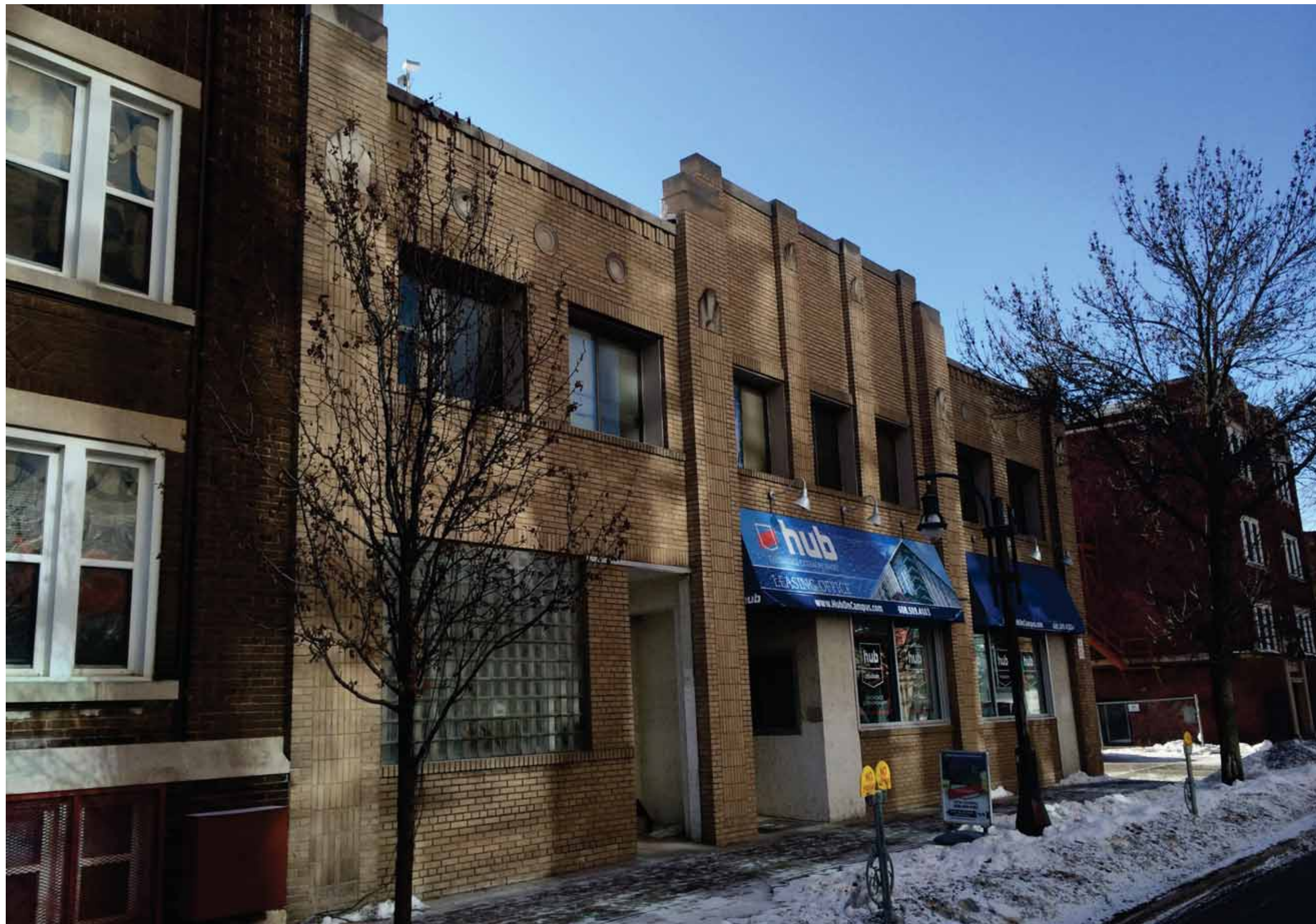

The Hub at Madison II - Conditional Use Application

Core Campus Developers | Antunovich Associates Architecture · Planning

Existing Facade - Today on Gilman Street

Madison, Wisconsin | February 24, 2015



The Hub at Madison II - Conditional Use Application

Core Campus Developers | Antunovich Associates Architecture · Planning

Existing Facade - Today on Gilman Street

Madison, Wisconsin | February 24, 2015



The Hub at Madison II - Conditional Use Application

Core Campus Developers | Antunovich Associates Architecture · Planning

Proposed Sidewalk View on Gilman Street

Madison, Wisconsin | February 24, 2015



The Hub at Madison II - Conditional Use Application

Core Campus Developers | Antunovich Associates Architecture · Planning

Proposed Sidewalk View on University Ave

Madison, Wisconsin | February 24, 2015



The Hub at Madison II - Conditional Use Application

Core Campus Developers | Antunovich Associates Architecture · Planning

Proposed Context View North East From University Ave

Madison, Wisconsin | February 24, 2015

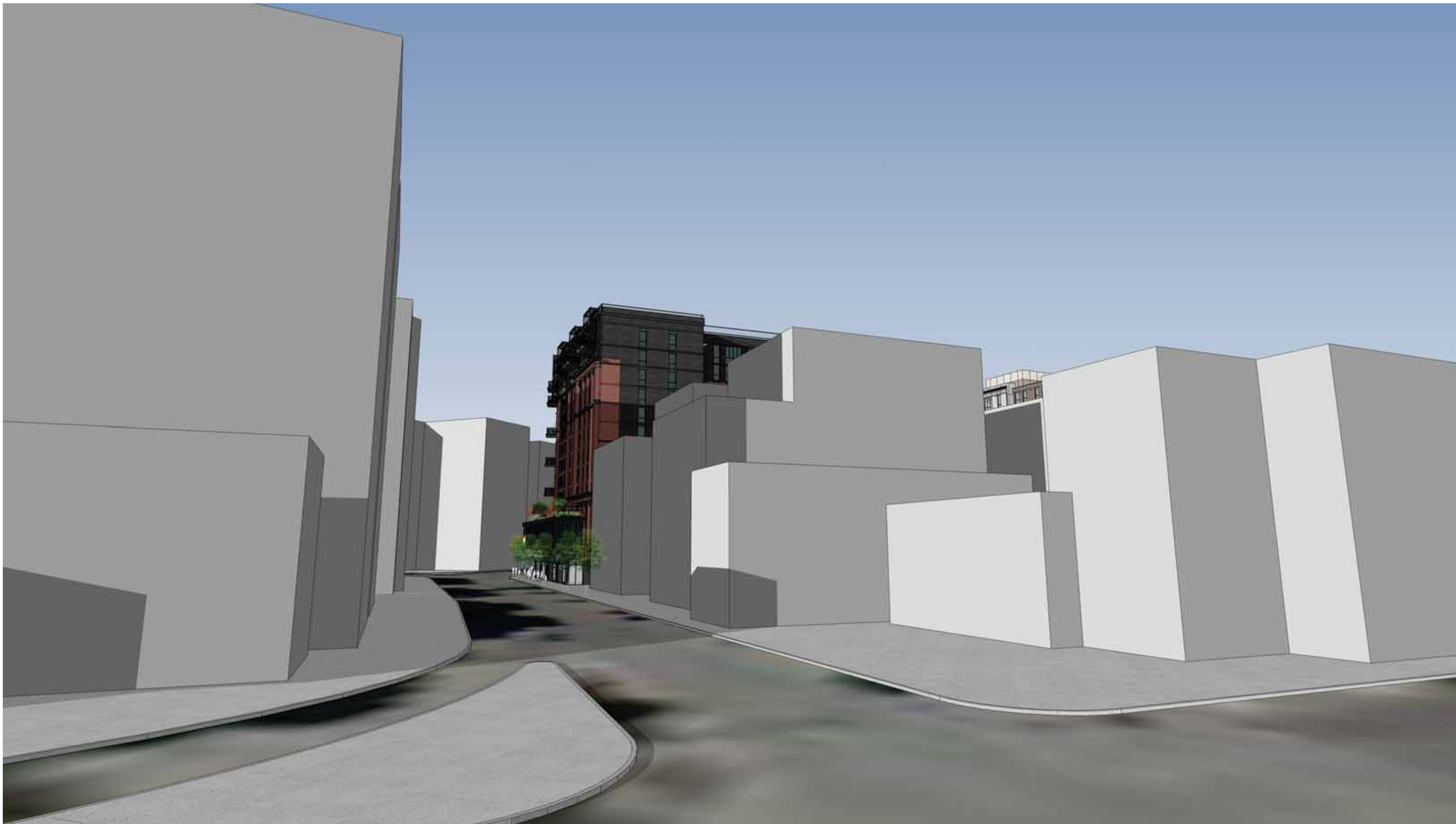

The Hub at Madison II - Conditional Use Application

Core Campus Developers | Antunovich Associates Architecture · Planning

Proposed Context View South West on Gorham Street

Madison, Wisconsin | February 24, 2015

