

LANDSCAPE CALCULATIONS
 PARKING LOT AREA = 7,900 SF =
 395 SF INTERIOR ISLANDS = 3 CANOPY TREES

E. WASH. AVE. FRONTAGE = 72' = 3 CANOPY TREES, 15 SHRUBS
 S. BLOUNT ST. FRONTAGE = 124' = 4 CANOPY TREES, 20 SHRUBS
 (S. BLOUNT FRONTAGE 154' - 30' FOR CORNER LOT OVERLAP)

400 SF X 3' DEEP
 SURFACE @ 848.50
 BIOSWALE PLUGS
 @ 12" OC

(2) *Quercus schuetei*
 Schuettes Oak Hybrid Swamp Bur Oak
 2" cal. B&B

(30) *Spirea betulifolia* 'Tor'
 Tor Birchleaf Spirea 12" ht. CG

(4) *Juniperus sabina* 'Arcadia'
 Arcadia Juniper 18" spr. CG

(2) *Gleditsia Triacanthos Inermis* 'Skyline'
 Skyline Honeylocust, 2" cal. B&B

INV NOT VISIBLE
 WATER SURFACE
 @ 844.90
 8" STORM SEWER
 FROM BACK OF INLET
 INV. 845.5

PRAIRIE SEEDING
 (ALL NON-PAVED AREAS
 EXCEPT BIOSWALE)

(3) *Acer freemanii* 'Armstrong'
 Armstrong Freeman Maple 2" cal. B&B

(6) *Cotoneaster* 'Hessei'
 Hesse Cotoneaster 18" spr CG

OVERFLOW
 RIM @ 849.00
 UNDERDRAIN
 INV @ 846.00

(4) SOLAR PARKING
 LOT LIGHTS

E. WASHINGTON AVE.

S. BLOUNT ST.

(3) *Ulmus wilsoniana* 'Prospector'
 Prospector Hybrid Elm 2" cal. B&B

NEW ASPH. PARKING
 28 STALLS

REMOVE EXIST. FENCE

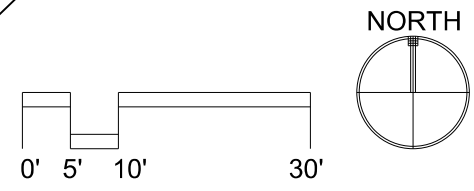

PARKING LOT FOR 665 E. WASHINGTON AVE.
 3/23/2015
 SITE PLAN 1" = 20' @ 11" x 17"
 KEN SAIKI DESIGN, LANDSCAPE ARCHITECTS
 608-251-3600

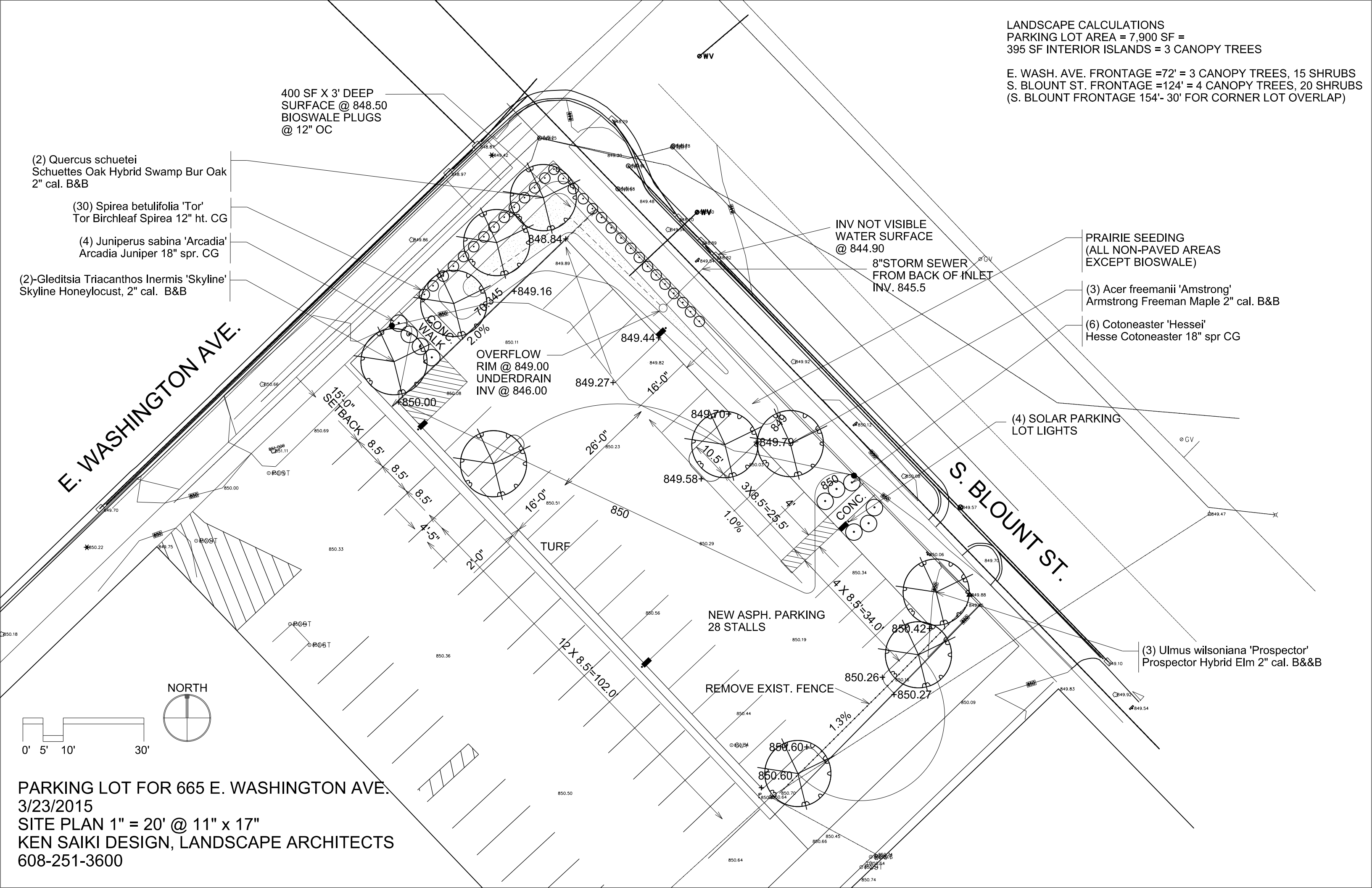

OVERVIEW

The Top of Pole Series features an adjustable mounting bracket and includes a variety of option choices to create a customized outdoor solar light solution for your application. The system is configured according to your location and lighting requirements to run throughout the night or to save energy with dimming when full light is not required. The battery enclosure and PV module mounts to your pole – square, round, fiberglass, steel, aluminum or concrete with supplied tenon.

WHY SOLAR?



REMOTE LOCATIONS

- Where grid is difficult to access
- Sensitive environments



IMMEDIATE ENERGY SAVINGS

- No energy costs throughout life of product



LOWER INSTALLATION COSTS

- No trenching or cabling
- Shorter installation time compared to on grid systems



GREEN STATEMENT

- Viable and sustainable energy alternative
- Recyclable battery and components

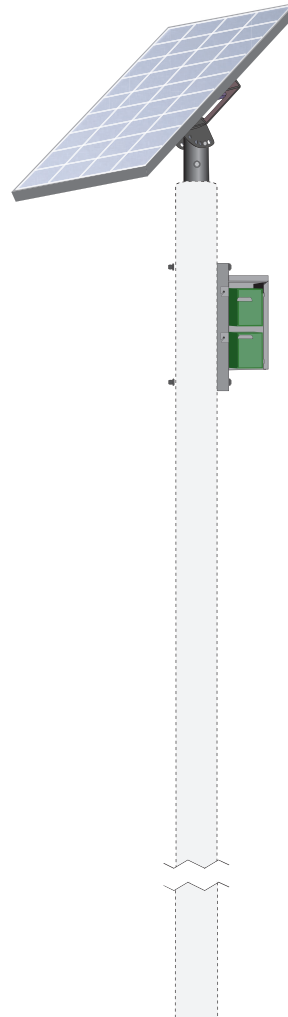

LED FIXTURES



Cree XSPR™ LED Street/Area Light

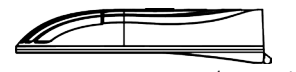

Cree XSP1™ LED Street/Area Light



Cree XSP2™ LED Street/Area Light



Cree OSQ™ LED Street/Area Light



Cree EDGE™ LED Street/Area Light

Decorative Luminaire Series available. See Decorative Datasheets for more info.

OUR DIFFERENCE

INDUSTRY-LEADING EXPERTISE

- World leader in solar LED lighting solutions, since 1990
- Publicly traded on the TSX (CMH)
- Extensive experience in outdoor lighting industry
- Manufactured in an ISO 9001 facility

ADVANCED LIGHTING TECHNOLOGY

- Designed for lighting applications
- Dimming and operating profiles for adaptive lighting
- Superior LED lighting and fixtures

CUSTOM SOLUTION FOR YOUR APPLICATION

- Precision-engineered for your application
- Array of solar engines available for your portfolio
- Aesthetic-design and value-built engine options

EternO[®] 4 ENERGY MANAGEMENT SYSTEM

The EternO[®] 4 ensures bright, reliable light output and healthy, high-functioning lighting systems with maintenance-free operation.

- Monitors and regulates charging and discharging of batteries
- Efficient transfer & dynamic management of energy (95% efficiency)
- Day/night transition via solar panel eliminates need for photocell
- Ten day/night memory averaging ensures accurate turn on/off of lights to prevent false response due to weather variations
- Allows for dimming of LED luminaire
- Temperature compensation and PWM controlled battery charging
- Low-voltage disconnect for battery protection

TECHNICAL SPECIFICATIONS

Solar Panel		PV Dimensions (Length x Width x Height)	*EPA @ 45degrees (Fixture and arm additional)	System Weight (Fixture and arm additional)	Pole Tenon
Single	125W	58.58 x 26.06 x 1.88 in 123.7 x 66.2 x 4.8 cm	10.07 ft ² .935 m ²	155 lbs 70.3 kg	3.5" O.D. 8.89 cm O.D.
	135W	59.1 x 26.3 x 1.81 in 150 x 66.8 x 4.6 cm	12.07 ft ² 1.12 m ²	210 lbs 95.25 kg	3.5" O.D. 8.89 cm O.D.
Double	125W	58.58 x 52.12 x 1.88 in 123.7 x 132.4 x 4.8 cm	19.0 ft ² 1.77 m ²	250 lbs 113.4 kg	3.5" O.D. 8.89 cm O.D.
	135W	59.1 x 52.6 x 1.81 in 150 x 133.6 x 4.6 cm	20.5 ft ² 1.90 m ²	245 lbs 111.13 kg	3.5" O.D. 8.89 cm O.D.
Triple	125W	58.58 x 78.18 x 1.88 in 123.7 x 198.6 x 4.8 cm	27.0 ft ² 2.5 m ²	440 lbs 199.58 kg	3.5" O.D. 8.89 cm O.D.
	135W	59.1 x 78.9 x 1.81 in 150 x 200.4 x 4.6 cm	28.5 ft ² 2.96 m ²	435 lbs 197.31 kg	3.5" O.D. 8.89 cm O.D.
Quad	125W	58.58 x 104.24 x 1.88 in 123.7 x 264.8 x 4.8 cm	41 ft ² 3.81 m ²	427 lbs 193.68 kg	6" O.D. 3.5 cm O.D.
	135W	59.1 x 105.2 x 1.81 in 150 x 267.2 x 4.6 cm	42.5 ft ² 3.94 m ²	422 lbs 191.41 kg	6" O.D. 3.5 cm O.D.

* System weight and EPA may vary with number of fixtures and batteries. The chart above is for reference only. Sol provides a calculated EPA and weight when a system is quoted and submitted.

SYSTEM DATA	
System Colors	Aluminum/Silver; Bronze
Material	Grade "A" corrosion resistant aluminum for battery enclosure and solar panel frame
Security	Security bolts used to fasten cover. Battery box mounted at top of pole to reduce vandalism and theft opportunities.
Options	Panel Pan for certain combinations
Warranty	5 year system warranty, additional pass-through of existing warranties, batteries pro-rated
BATTERY	
Type	Maintenance-free, lead acid gel cell battery; spill-proof, leak-proof
Rating	1800 cycles to 20% Depth of Discharge at 20°C (68°F)
FIXTURE	
Types of Compatible Fixtures	Cree XSP Series™ LED Street/Area Luminaire; Cree EDGE luminaire; decorative options - see decorative datasheets
IES Light Distributions	Type 2 Long, 3 Med, 4 Med, 5 Short
Color Temperature Options	4000K; 5700K
Color Rendering Index (CRI)	Minimum 70CRI
Mounting	Mounts on 1.25" IP, 1.66" (42mm) O.D. or 2" IP, 2.375" (60mm) O.D. horizontal tenon (minimum 8" [203mm] in length) and is adjustable +/- 5° to allow for fixture leveling; tool-less entry
CONTROLLER	
Type	EternO 4® integrated solar charge controller and LED driver
Optional Operating Profiles	Dusk to Dawn; 9 Dim 2; 7 Dim 2; 5 Dim 2; 7 Off 2; 7 Off
Day/Night Transition	Via solar panels
CERTIFICATIONS	
Battery	Built to comply with IES 896-2, DIN 43534, BS 6290 Pt4, Eurobat; UL Recognized
Fixture	cULus Listed
	Certified to ANSI C136.31-2001 3G Bridge and Overpass Vibration Standards
	Meets CALTrans 611 Vibration testing
	Meets Buy American requirements within ARRA
	Suitable for wet locations
Controller	Luminaire and finish endurance tested to withstand 5000 hours of elevated ambient salt fog conditions as defined in ASTM Standard B 117
	TUV listed to UL 60950-1:2007 CSA C22.2.60950-1:2007

*(Effective Projected Area) at 0° Power Unit + Arm + Battery Box + Fixture

Specifications subject to change without notice.

Document: SOL_TP_Spec_Sheet_RevB



LANDSCAPE
ARCHITECTS

April 15, 2015
Revised May 26, 2015 (revision highlighted)

City of Madison
Re: 665 E. Washington Ave.

The attached information describes a **private** parking lot at the subject address being proposed by Curt Brink on a parcel owned by MG & E. The existing parcel is vacant, is currently covered in grass.

- The proposed parking lot contains 28 parking stalls.
- The plan provides a bioretention area designed to comply with ordinance related to the TMDL removal of sediment.
- The planting complies with zoning requirements for parking lot and lot frontage landscape.
- The parking lot is proposed to be illuminated with 4 solar powered parking lot lights that will meet illumination and cutoff requirements.

Planning and Zoning staff have been contacted for this project, as well as the neighborhood association. The plan has been approved by the preservation and development committee of the neighborhood association at their meeting on 4/1/2015.

The plan was approved by MNA Board on 4/16/2015.

We look forward to working with you on the project. Please contact me at (608) 251-3600 if you have any questions or need additional information.

Sincerely,

Ken Saiki, ASLA
Ken Saiki Design, Inc.

Cc: Curt Brink

ARE-EDG-4MB/4MP-DA

Cree Edge™ Area Luminaires – Type IV Medium w/ Backlight Control – Direct Arm Mount

Product Description

Slim, low profile design minimizes wind load requirements. Luminaire sides are rugged cast aluminum with integral, weathertight LED driver compartments and high performance aluminum heat sinks. Convenient, interlocking mounting method. Mounting housing is rugged die cast aluminum and mounts to 3–6" (76–152mm) square or round pole. Luminaire is secured by two 5/16-18 UNC bolts spaced on 2" (51mm) centers.

Performance Summary

Utilizes BetaLED® Technology
Patented NanoOptic® Product Technology
Made in the U.S.A, of U.S, and imported parts
CRI: Minimum 70 CRI
CCT: 5700K (+ / - 500K) Standard, 4000K (+ / - 300K)
Limited Warranty*: 10 years on luminaire / 10 years on Colorfast DeltaGuard® finish
EPA and Weight: Reference EPA and Weight spec sheet

Accessories

Field Installed Accessories
XA-BRDSPK Bird Spikes

Select Color

Ordering Information

Example: ARE-EDG-4MB-DA-04-E-UL-SV-350-OPTIONS

ARE-EDG	DA	E						
Product	Optic	Mounting	LED Count (x10)	Series	Voltage	Color Options	Drive Current	Options
ARE-EDG	4MB Type IV Medium w / BLS	DA Direct Arm	04 06 08 10 12 14 16 20 24	E	UL Universal 120–277V UH Universal 347–480V 34 347V	SV Silver (Standard) BK Black BZ Bronze PB Platinum Bronze WH White	350* 350mA 525* 525mA 700** 700mA	40K 4000K Color Temperature - Color temperature per luminaire DIM 0–10V Dimming - Control by others - Refer to dimming spec sheet for details - Can't exceed specified drive current F Fuse - When code dictates fusing, use time delay fuse - Not available with all ML options, Refer to ML spec sheet for availability with ML options HL Hi / Low (175 / 350 / 525 Dual Circuit Input) - Refer to ML spec sheet for details - Sensor not included P Photocell - Not available with all ML options, Refer to ML spec sheet for availability with ML options - Must specify voltage other than UH R NEMA Photocell Receptacle - Not available with all ML options, Refer to ML spec sheet for availability with ML options - Photocell by others ML Multi-Level - Refer to ML spec sheet for details

* See www.cree.com/lighting/products/warranty for warranty terms

* Available on luminaires with 60–240 LEDs.

** Available on luminaires with 40–160 LEDs.

*** Available on luminaires with 40–60 LEDs.

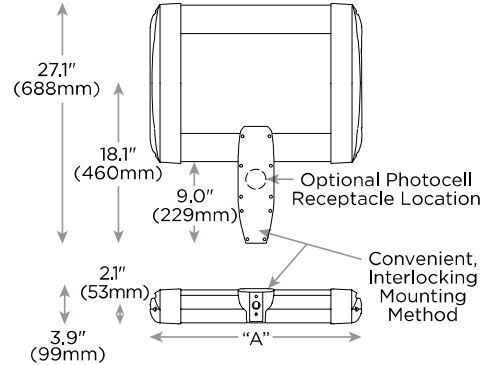

LED Count (x10)	Dim. "A"
04	12.1" (306mm)
06	14.1" (357mm)
08	16.1" (408mm)
10	18.1" (459mm)
12	20.1" (510mm)
14	22.1" (560mm)
16	24.1" (611mm)
20	28.1" (713mm)
24	32.1" (814mm)



Rev. Date: 09/27/13



Product Specifications

CONSTRUCTION & MATERIALS

- Slim, low profile, minimizing wind load requirements
- Luminaire sides are rugged die cast aluminum with integral, weathertight LED driver compartments and high performance heat sinks
- Convenient interlocking mounting method. Mounting housing is rugged die cast aluminum mounting to 3-6" (76-152mm) square or round pole, secured by two 5 / 16-18 UNC bolts spaced on 2" (51mm) centers
- Includes leaf / debris guard
- Exclusive Colorfast DeltaGuard® finish features an E-Coat epoxy primer with an ultra-durable powder topcoat, providing excellent resistance to corrosion, ultraviolet degradation and abrasion. Standard is silver. Bronze, black, white, and platinum bronze are also available

ELECTRICAL SYSTEM

- **Input Voltage:** 120-277V or 347-480V, 50 / 60Hz, Class 1 drivers
- **Power Factor:** > 0.9 at full load
- **Total Harmonic Distortion:** < 20% at full load
- Integral weathertight electrical box with terminal strips (12Ga-20Ga) for easy power hookup
- Integral 10kV surge suppression protection standard
- To address inrush current, slow blow fuse or type C / D breaker should be used

REGULATORY & VOLUNTARY QUALIFICATIONS

- cULus Listed
- Suitable for wet locations
- Enclosure rated IP66 per IEC 60529 when ordered without P or R options
- Consult factory for CE Certified products
- Certified to ANSI C136.31-2001, 3G bridge and overpass vibration standards
- 10kV surge suppression protection tested in accordance with IEEE / ANSI C62.41.2
- Luminaire and finish endurance tested to withstand 5,000 hours of elevated ambient salt fog conditions as defined in ASTM Standard B 117
- Product qualified on the DesignLights Consortium™ ("DLC") Qualified Products List ("QPL") when ordered without full backlight control shield
- Meets Buy American requirements within ARRA

Photometry

All luminaires photometric testing performed to IESNA LM-79-08 standards by a NVLAP certified laboratory.

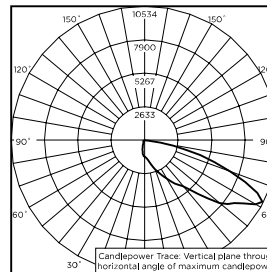

CSA Test Report #: 6449
ARE-EDG-4MB-**-12-E-UL-525-40K
Initial Delivered Lumens: 13,155

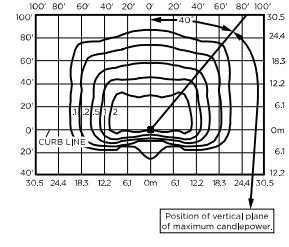

ARE-EDG-4MB-**-12-E-UL-525-40K
Mounting Height: 25' (7.6m) A.F.G.
Initial Delivered Lumens: 13,340
Initial FC at grade

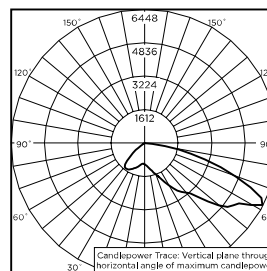

CSA Test Report #: 6417
ARE-EDG-4MP-**-06-E-UL-700-40K
Initial Delivered Lumens: 9,989

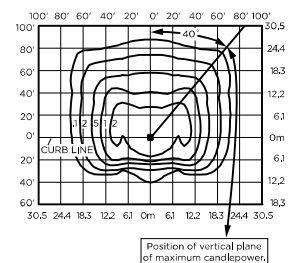

ARE-EDG-4MP-**-12-E-UL-525-40K
Mounting Height: 25' (7.6m) A.F.G.
Initial Delivered Lumens: 15,640
Initial FC at grade

IES Files

To obtain an IES file specific to your project consult:
<http://www.cree.com/lighting/tools-and-support/exterior-ies-configuration-tool>

Lumen Output, Electrical, and Lumen Maintenance Data

LED Count (x10)	Type IV Medium Distribution w/ BLS								System Watts 120-480V	TOTAL CURRENT						50K Hours Projected Lumen Maintenance Factor @ 15° C (59° F)***
	5700K				4000K					120V	208V	240V	277V	347V	480V	
	Initial Delivered Lumens w/ BLS*	BUG Ratings** Per TM-5-II	Initial Delivered Lumens w/ Partial BLS*	BUG Ratings** Per TM-5-II	Initial Delivered Lumens w/ BLS*	BUG Ratings** Per TM-5-II	Initial Delivered Lumens w/ Partial BLS*	BUG Ratings** Per TM-5-II								
350mA @ 25° C (77° F)																
06	4,959	B1 U0 G1	5,815	B1 U0 G1	4,776	B1 U0 G1	5,599	B1 U0 G1	66	0.52	0.31	0.28	0.26	0.20	0.15	93%
08	6,613	B1 U0 G2	7,753	B2 U0 G2	6,368	B1 U0 G2	7,466	B2 U0 G2	90	0.75	0.44	0.38	0.34	0.26	0.20	
10	8,246	B1 U0 G2	9,668	B2 U0 G2	7,941	B1 U0 G2	9,310	B2 U0 G2	110	0.92	0.53	0.47	0.41	0.32	0.24	
12	9,895	B1 U0 G2	11,601	B2 U0 G2	9,529	B1 U0 G2	11,172	B2 U0 G2	130	1.10	0.63	0.55	0.48	0.38	0.28	
14	11,471	B1 U0 G2	13,449	B2 U0 G2	11,046	B1 U0 G2	12,951	B2 U0 G2	158	1.32	0.77	0.68	0.62	0.47	0.35	
16	13,110	B1 U0 G2	15,370	B3 U0 G2	12,624	B1 U0 G2	14,801	B3 U0 G2	179	1.49	0.87	0.77	0.68	0.53	0.39	
20	16,388	B2 U0 G3	19,213	B3 U0 G3	15,781	B2 U0 G3	18,501	B3 U0 G2	220	1.84	1.06	0.93	0.83	0.64	0.47	
24	19,665	B2 U0 G3	23,056	B3 U0 G3	18,937	B2 U0 G3	22,202	B3 U0 G3	261	2.19	1.26	1.10	0.97	0.76	0.56	
525mA @ 25° C (77° F)																
04	4,682	B1 U0 G1	5,490	B1 U0 G1	4,509	B1 U0 G1	5,286	B1 U0 G1	70	0.58	0.34	0.31	0.28	0.21	0.16	92%
06	6,943	B1 U0 G2	8,140	B2 U0 G2	6,686	B1 U0 G2	7,839	B2 U0 G2	101	0.84	0.49	0.43	0.38	0.30	0.22	
08	9,258	B1 U0 G2	10,854	B2 U0 G2	8,915	B1 U0 G2	10,452	B2 U0 G2	133	1.13	0.66	0.58	0.51	0.39	0.28	
10	11,544	B1 U0 G2	13,535	B2 U0 G2	11,117	B1 U0 G2	13,034	B2 U0 G2	171	1.43	0.83	0.74	0.66	0.50	0.38	
12	13,853	B2 U0 G2	16,242	B3 U0 G2	13,340	B1 U0 G2	15,640	B3 U0 G2	202	1.69	0.98	0.86	0.77	0.59	0.44	
14	16,060	B2 U0 G3	18,829	B3 U0 G2	15,465	B2 U0 G2	18,131	B3 U0 G2	232	1.94	1.12	0.98	0.87	0.68	0.50	
16	18,354	B2 U0 G3	21,519	B3 U0 G3	17,674	B2 U0 G3	20,722	B3 U0 G3	263	2.21	1.27	1.11	0.97	0.77	0.56	
700mA @ 25° C (77° F)																
04	5,719	B1 U0 G2	6,705	B2 U0 G1	5,507	B1 U0 G1	6,457	B2 U0 G1	92	0.78	0.46	0.40	0.36	0.27	0.20	90%
06	8,481	B1 U0 G2	9,943	B2 U0 G2	8,167	B1 U0 G2	9,575	B2 U0 G2	134	1.14	0.65	0.57	0.50	0.39	0.29	

* Actual production yield may vary between -4 and +10% of initial delivered lumens.
** For more information on the IES BUG (Backlight-Uplight-Glare) Rating visit: www.esna.org/PDF/Erratas/TM-5-II-BugRatingsAddendum.pdf.
*** For recommended Lumen maintenance factor data see TD-13, Calculated L₈₀ based on 6,000 hours LM-80-08 testing: > 150,000 hours.





Excellence in Illumination Engineering Software
since 1984



sample banner copyright 2013 Lighting Analysts, Inc.

Photometric Report (Type C)

Filename: ARE-EDG-4MB-__-04-E-UL-350-40K-CONFIGURED.IES
[TEST] CONFIGURED FROM 6,449 Job Number-2632589
[TESTLAB] CSA Group
[ISSUEDATE] 6/3/2013 3:18:31 PM
[MANUFAC] CREE INC.
[LUMCAT] ARE-EDG-4MB-**-04-E-UL-350-40K (350mA)
CONFIGURED FROM ARE-EDG-4MB-DA-12-E-UL-XX-525-40K
(BXAL1J12E-UC7)
[LUMINAIRE] CONFIGURED FROM Cree Edge Area, Type IV
Medium w- Full BLS, 120 LEDs, 525mA, 4000K
[LAMP] CONFIGURED FROM One Hundred Twenty White LEDs,
Vertical Base-Up Position

Maximum Candela = 2579 at 40 H 62.5 V

Classification:

Road Classification: Type III, Short, N.A. (deprecated)
Upward Wast Light Ratio: 0.00
Luminaire Efficacy Rating (LER): 75
Indoor Classification: Direct
BUG Rating : B1-U0-G1

Polar Candela Curves:

Vertical Plane Through:
1) 40 - 220 Horizontal

Horizontal Cone Through:
2) 62.5 Vertical

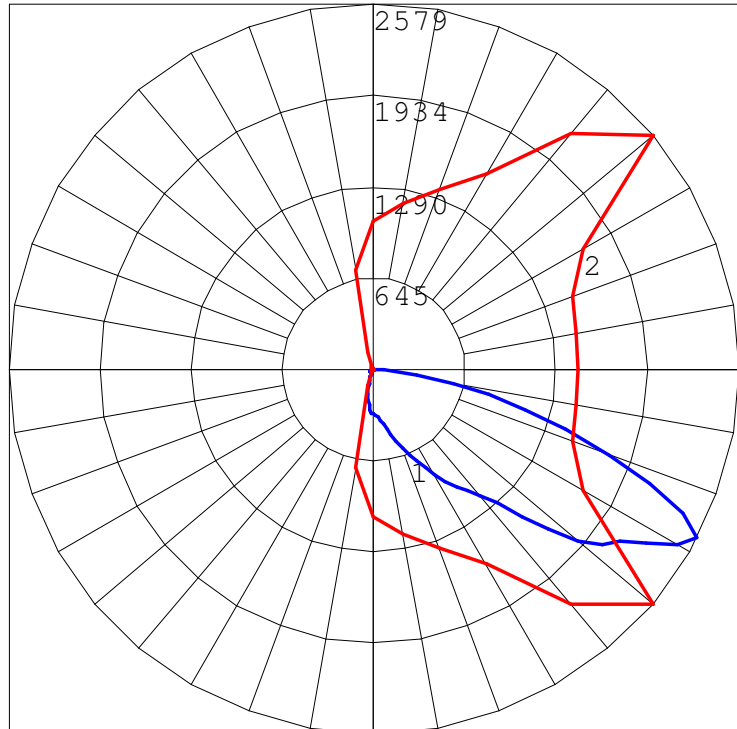



Excellence in Illumination Engineering Software
since 1984



sample banner copyright 2013 Lighting Analysts, Inc.

Photometric Report (Type C)

Filename: ARE-EDG-4MB-__-04-E-UL-350-40K-CONFIGURED.IES
 [TEST] CONFIGURED FROM 6,449 Job Number-2632589
 [TESTLAB] CSA Group
 [ISSUE DATE] 6/3/2013 3:18:31 PM
 [MANUFAC] CREE INC.
 [LUMCAT] ARE-EDG-4MB-**-04-E-UL-350-40K (350mA)
 CONFIGURED FROM ARE-EDG-4MB-DA-12-E-UL-XX-525-40K
 (BXAL1J12E-UC7)
 [LUMINAIRE] CONFIGURED FROM Cree Edge Area, Type IV
 Medium w- Full BLS, 120 LEDs, 525mA, 4000K
 [LAMP] CONFIGURED FROM One Hundred Twenty White LEDs,
 Vertical Base-Up Position

Maximum Candela = 2579 at 40 H 62.5 V

Classification:

Road Classification: Type III, Short, N.A. (deprecated)
 Upward Waste Light Ratio: 0.00
 Luminaire Efficacy Rating (LER): 75
 Indoor Classification: Direct
 BUG Rating : B1-U0-G1

LCS Summary:

LCS Zone	Lumens	%Lamp	%Lum
FL (0-30)	247.9	N.A.	7.7
FM (30-60)	1513.1	N.A.	47.0
FH (60-80)	1020.6	N.A.	31.7
FVH (80-90)	38.2	N.A.	1.2
BL (0-30)	79.5	N.A.	2.5
BM (30-60)	235.6	N.A.	7.3
BH (60-80)	82.5	N.A.	2.6
BVH (80-90)	2.7	N.A.	0.1
UL (90-100)	0.0	N.A.	0.0
UH (100-180)	0.0	N.A.	0.0
Total	3220.1	N.A.	100.0
BUG Rating	B1-U0-G1		

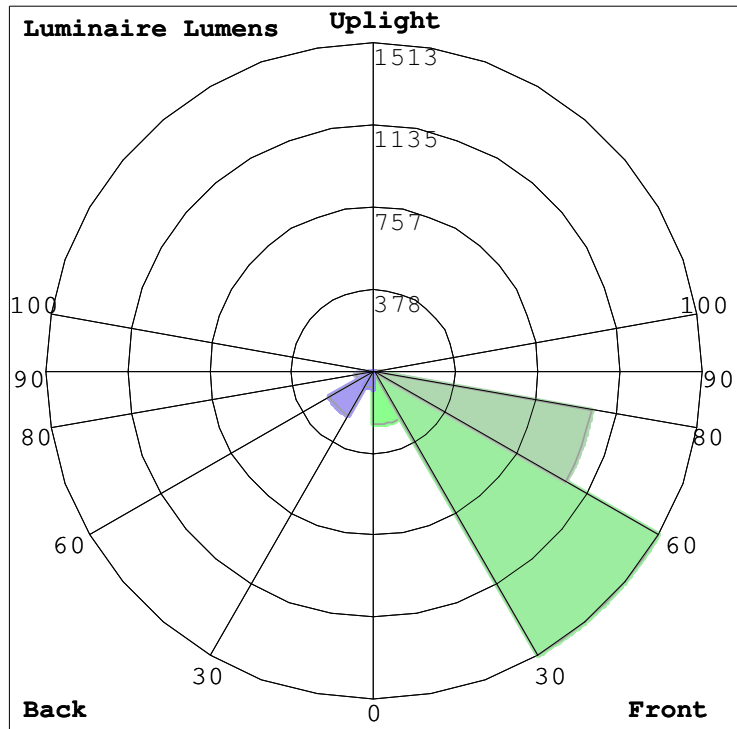

LANDSCAPE CALCULATIONS
 PARKING LOT AREA = 7,900 SF =
 395 SF INTERIOR ISLANDS = 3 CANOPY TREES

E. WASH. AVE. FRONTAGE = 72' = 3 CANOPY TREES, 15 SHRUBS
 S. BLOUNT ST. FRONTAGE = 124' = 4 CANOPY TREES, 20 SHRUBS
 (S. BLOUNT FRONTAGE 154'- 30' FOR CORNER LOT OVERLAP)

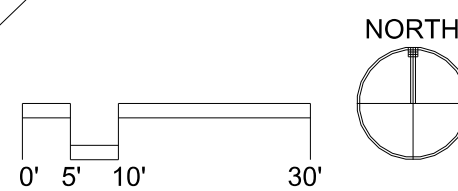
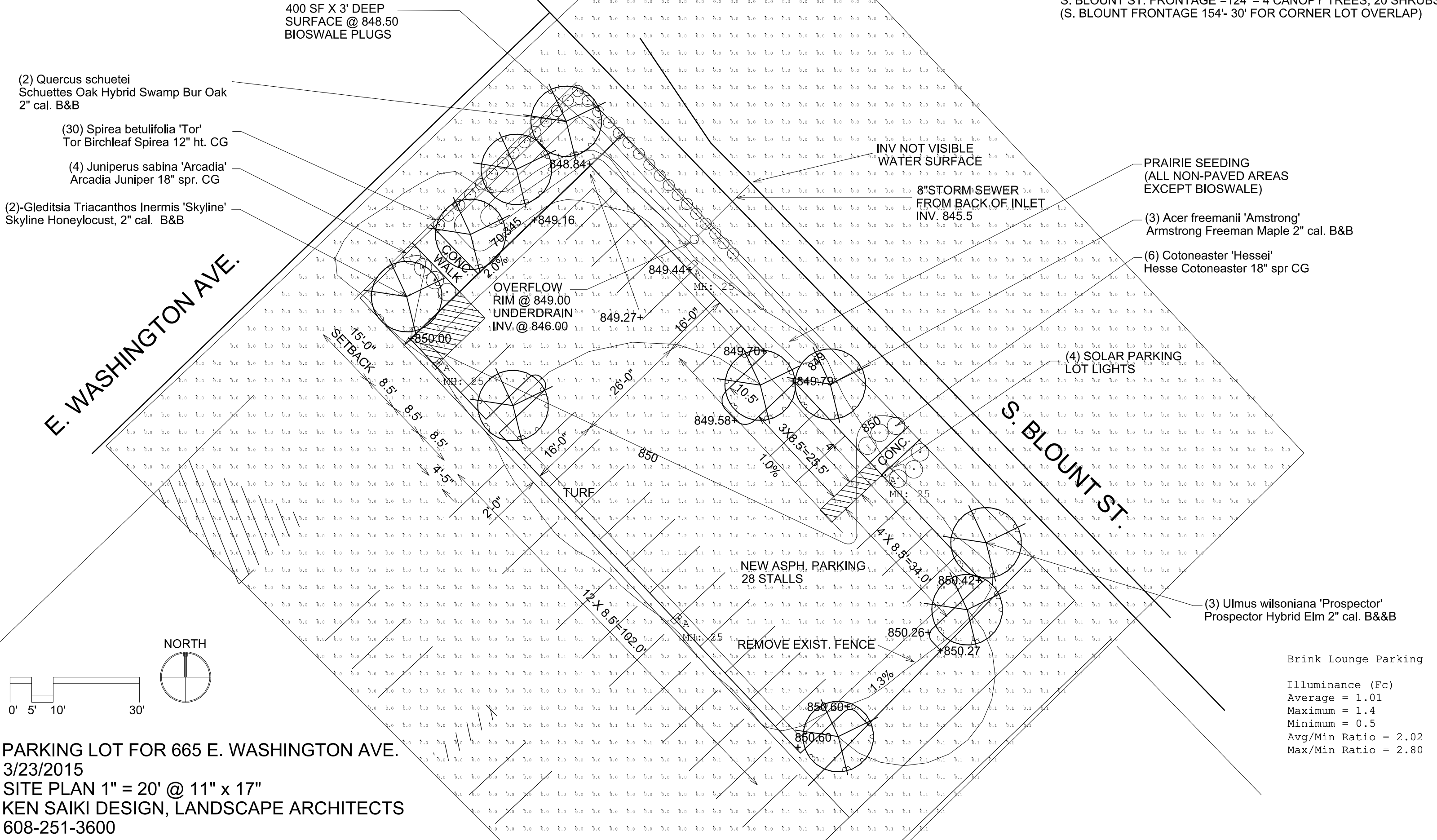

PARKING LOT FOR 665 E. WASHINGTON AVE.
 3/23/2015
 SITE PLAN 1" = 20' @ 11" x 17"
 KEN SAIKI DESIGN, LANDSCAPE ARCHITECTS
 608-251-3600