

**VARIANCE FEES**

MGO \$50.00  
COMM \$490.00  
Priority - Double above

**PETITION FOR VARIANCE APPLICATION**

City of Madison  
Building Inspection  
Division  
215 Martin Luther King Jr. Blvd.  
Madison, WI 53703  
(608) 266-4568

Amount Paid 490 7/12/16 FMR

Name of Owner Bob Lindholm	Project Description New mixed use development at 2505-2525 University Avenue.	Agent, architect, or engineering firm Gary Brink & Associates, Inc.
Company (if applies) Lindholm Properties		No. & Street 7780 Elmwood Avenue, Suite 204
No. & Street 14 Carillon Drive	Tenant name (if any)	City, State, Zip Code Middleton, WI 53562
City, State, Zip Code Madison, WI 53705	Building Address 2505-2525 University Avenue	Phone (608) 829-3056
Phone (608) 238-8888		Name of Contact Person Brenda McClure
e-mail rlindholm19@yahoo.com		e-mail brenda.mcclure@garybrink.com

1. The rule being petitioned reads as follows: (Cite the specific rule number and language. Also, indicate the nonconforming conditions for your project.)  
 IBC 1104.2 - At least one accessible route shall connect accessible buildings, accessible facilities, accessible elements and accessible spaces that are on the same site. The accessible parking stall provided is located on the 2525 University Avenue property and, therefore, can't be counted for the parking serving the 2505 building.

2. The rule being petitioned cannot be entirely satisfied because:  
 There is a limited amount of space available to provide parking on the 2505 University Avenue site.



3. The following alternatives and supporting information are proposed as a means of providing an equivalent degree of health, safety, and welfare as addressed by the rule:  
 The existing Shared Parking & Ingress/Egress Easement will be amended to include both the accessible stall and the access aisle on the west side of the parking lot in order to provide an accessible stall for 2505 University Avenue and meet the requirements of IBC 1104.2.

Note: Please attach any pictures, plans, or required position statements.

**VERIFICATION BY OWNER – PETITION IS VALID ONLY IF NOTARIZED AND ACCOMPANIED BY A REVIEW FEE AND ANY REQUIRED POSITION STATEMENTS.**

Note: Petitioner must be the owner of the building. Tenants, agents, contractors, attorneys, etc. may not sign the petition unless a Power of Attorney is submitted with the Petition for Variance Application.

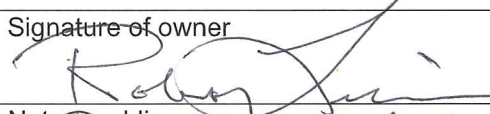
Bob Lindholm, being duly sworn, I state as petitioner that I have read the foregoing petition, that I believe it to be true, and I have significant ownership rights in the subject building or project.

Signature of owner 	Subscribed and sworn to before me this date: 7-12-16
Notary public 	My commission expires: 6-15-18

**NOTE: ONLY VARIANCES FOR COMMERCIAL CODES ARE REQUIRED TO BE NOTARIZED.**

First Amended  
Shared Parking & Ingress/Egress Easement, Covenants and Restrictions

This First Amended Shared Parking & Ingress/Egress Easement, Covenants and Restrictions amends by replacing in its entirety that Shared Parking & Ingress/Egress Easement, Covenants and Restrictions document recorded as document Number 5196507 on 11/09/2015 at the Register of Deeds for Dane County.

Whereas, Lindholm Properties 2525 University LLC ("Owner") is the owner and developer of real property and the related appurtenances and infrastructure referred to hereafter as "The Premises."

DEFINITIONS:

"The Premises" are particularly described in the attached **legal description**.

"Owner" refers to Lindholm Properties 2525 University LLC which is the current owner of The Premises."

"Lot 1 Owner" refers to Owner as well as Owner's successors and assigns in the ownership of Lot 1.

"Lot 2 Owner" refers to Owner as well as Owner's successors and assigns in the ownership of Lot 2.

"Party" refers to Lot 1 Owner and Lot 2 Owner.

Whereas, Owner and its successors and assigns will each benefit through a mutual ingress/egress easement and shared parking easement;

NOW THEREFORE, the undersigned Owner, hereby declares, covenants and agrees as follows:

1. The Premises consist of Lot 1 and Lot 2, and Owner currently owns both Lot 1 and Lot 2. This declaration is entered into in contemplation of the eventual transfer of one or both portions of the Premises, and this declaration is for the benefit of Owner and its successors and assigns including Lot 1 Owner and Lot 2 Owner.
2. **PARKING AND INGRESS/EGRESS AREA EASEMENT GRANT:** The easements granted below may be used by Lot 1 Owner and Lot 2 Owner and their tenants, employees, customers, and invitees in common.
  - a. Lot 1 Owner does hereby grant an easement over that area of Lot 1 depicted in the attached shared parking & ingress/egress easement map and declares that Lot 1 is subject to, encumbered by, and shall be conveyed subject to and for the benefit of each Party, a perpetual non-exclusive ingress and egress and parking easement.
  - b. Lot 2 Owner does hereby grant an easement over that area of Lot 2 depicted in the attached shared parking & ingress/egress easement map and declares that Lot 2 is subject to, encumbered by, and shall be conveyed subject to and for the benefit of each Party, a perpetual non-exclusive ingress and egress and parking easement.
  - c. The easement granted may be used by Lot 1 Owner and Lot 2 Owner and their tenants, employees, customers, and invitees in common.
3. **INITIAL CONSTRUCTION COSTS:** The initial construction costs for the installation of the construction of the driveway and parking area shall be borne by Lot 1 Owner.
4. **MAINTENANCE COSTS.** Responsibility for all maintenance, repairs, upkeep and replacement expenses on the easement area shall be split 50/50 by and between Lot 1 Owner and Lot 2 Owner. Unless Lot 1 Owner and Lot 2 Owner agree otherwise, all maintenance, repair, and removal shall be performed by Lot 1 Owner, and Lot 2 Owner agrees to promptly pay its share of the expenses of maintenance, repair, and removal incurred by Lot 1 Owner within 30 days of billing for the expenses. If Lot 2 Owner does not promptly pay its share, Lot 1 Owner may pay the full cost and then have an immediate right to reimbursement from Lot 2

Drafted by and return to:  
Attorney James N Graham  
6401 Odana Road  
Madison, WI 53719

-----  
Parcel Numbers:  
See attached

Owner, together with interest at the rate of 18% per year on the unpaid amount and all reasonable attorney fees and other collection costs incurred. Repairs and maintenance shall be performed at such times and in such a manner as are mutually agreeable to the parties. If the parties are unable to agree within 10 days of a written request by one or the other on the need for the repair or maintenance, then the matter shall be referred, upon either party's request, to arbitration.

5. **Indemnity.**

- a. Lot 1 Owner shall indemnify and defend Lot 2 Owner and its officers, agents, and employees from all liability, suits, actions, claims, costs, damages, and expenses of every kind and description, including court costs and legal fees, for claims of any character, including liability and expenses in connection with the loss of life, personal injury, or damage to property, brought because of any injuries or damages received or sustained by any person, persons, or property on account of or arising out of the use of Lot 2 by Lot 1 Owner or its agents, contractors, subcontractors, invitees, or employees.
- b. Lot 2 Owner shall indemnify and defend Lot 1 Owner and its officers, agents, and employees from all liability, suits, actions, claims, costs, damages, and expenses of every kind and description, including court costs and legal fees, for claims of any character, including liability and expenses in connection with the loss of life, personal injury, or damage to property, brought because of any injuries or damages received or sustained by any person, persons, or property on account of or arising out of the use of Lot 1 by Lot 2 Owner or its agents, contractors, subcontractors, invitees, or employees.

6. **Insurance.** Lot 1 Owner shall maintain in effect at all times during the term of this Agreement a policy of commercial general liability insurance naming Lot 2 Owner and any other party designated by Lot 2 Owner as the insured, to insure against injury to property, person, or loss of life arising out of Lot 1 Owner's use, occupancy, or maintenance of the Easement Property or the Driveway with limits of coverage that are at levels customarily maintained by businesses in the community in which the Easement Property is located. For each year in which this easement is in effect, Lot 1 Owner shall provide Lot 2 Owner and the other parties designated by Lot 2 Owner with a copy of the insurance policy endorsement or wording showing that Lot 2 Owner and the other parties have been added as additional insureds. The policy shall contain a supplemental endorsement covering contractual liability voluntarily assumed by the insured under this Agreement. Insurance required of Lot 1 Owner under this Agreement shall be written by companies duly qualified to do business in the State of Wisconsin and shall be satisfactory in all respects to Lot 2 Owner and the holder of any mortgage against Lot 2. Lot 1 Owner shall deliver to Lot 2 Owner copies of the policies or certificates evidencing the existence and amounts of the insurance with loss payable clauses satisfactory to Lot 2 Owner. No such policy shall be cancelable or subject to reduction of coverage or modification except after 30 days' prior written notice to Lot 2 Owner. At least 30 days before the expiration of Lot 1 Owner's policies, Lot 1 Owner shall furnish Lot 2 Owner with renewals or "binders" of the policies, or Lot 2 Owner may order such insurance and charge the cost to Lot 1 Owner. Lot 1 Owner shall not do or permit anything to be done that will invalidate the insurance policies furnished by Lot 1 Owner. Lot 2 Owner may from time to time require that the policy limits of any or all such insurance be increased to reflect the effects of inflation and changes in normal commercial insurance practice.

7. **Equal Rights of Use.** Lot 1 Owner and Lot 2 Owner shall have equal rights of ingress and egress over the Driveway and shall take no action to prevent the other party's enjoyment of such rights.

8. **Covenants Run with Land.** All of the terms and conditions in this Agreement, including the benefits and burdens, shall run with the land and shall be binding upon, inure to the benefit of, and be enforceable by Lot 1 Owner and Lot 2 Owner and their respective successors and assigns. The easement granted under Section 1 of this Agreement is an easement appurtenant to Lot 1 and may not be transferred separately from, or severed from, title to Lot 1. Furthermore, the benefits of the easements granted under this Agreement shall not be extended to any properties other than Lot 1 without the consent of Lot 2 Owner. The specific parties named as Lot 1 Owner and Lot 2 Owner in this Agreement, and each of their respective successors and assigns as fee simple owners of Lot 1 and Lot 2, respectively, or any portion of Lot 1 or Lot 2, shall cease to have further liability under this Agreement with respect to facts or circumstances first arising after the party has transferred its fee simple interest in Lot 1 or Lot 2, respectively, except, however, for obligations that accrued during the party's period of ownership of title.

9. **Non-Use.** Non-use or limited use of the easement rights granted in this Agreement shall not prevent either Lot 1 Owner or Lot 2 Owner from later use of the easement rights to the fullest extent authorized in this Agreement.

10. **Governing Law.** This Agreement shall be construed and enforced in accordance with the internal laws of the State of Wisconsin.

11. **Entire Agreement.** This Agreement sets forth the entire understanding of the parties and may not be changed except by a written document executed and acknowledged by all parties to this Agreement and duly recorded in the office of the Register of Deeds of Dane County, Wisconsin.

12. **Notices.** All notices to either party to this Agreement shall be delivered in person or sent by certified mail, postage prepaid, return receipt requested, to the other party at that party's last known address. If the other party's address is not known to the party desiring to send a notice, the party sending the notice may use the address to which the other party's property tax bills are sent. Either party may change its address for notice by providing written notice to the other party.

13. **Invalidity.** If any term or condition of this Agreement, or the application of this Agreement to any person or circumstance, shall be deemed invalid or unenforceable, the remainder of this Agreement, or the application of the term or condition to persons or circumstances other than those to which it is held invalid or unenforceable, shall not be affected thereby, and each term and condition shall be valid and enforceable to the fullest extent permitted by law.

14. **Waiver.** No delay or omission by any party in exercising any right or power arising out of any default under any of the terms or conditions of this Agreement shall be construed to be a waiver of the right or power. A waiver by a party of any of the obligations of the other party shall not be construed to be a waiver of any breach of any other terms or conditions of this Agreement.

15. **Enforcement.** Enforcement of this Agreement may be by proceedings at law or in equity against any person or persons violating or attempting or threatening to violate any term or condition in this Agreement, either to restrain or prevent the violation or to obtain any other relief. If a suit is brought to enforce this Agreement, the prevailing party shall be entitled to recover its costs, including reasonable attorney fees, from the nonprevailing party.

16. **No Public Dedication.** Nothing in this Agreement shall be deemed to be a gift or dedication of any portion of the easement granted under this Agreement to the general public or for any public purpose whatsoever. Lot 1 Owner and Lot 2 Owner agree to cooperate with each other and to take such measures as may be necessary to prevent the dedication to the public of the Driveway, whether by express grant, implication, or prescription, including, without limitation, the posting of "Private Drive" or "No Trespassing" signs. Such measures shall not, however, unreasonably interfere with the easement rights granted under this Agreement.

17. **RELEASE OF PRIOR EASEMENTS.** Lot One Owner and Lot Two Owner, as successors and assigns to all beneficial interest in and as dominant owners of the easements created or referenced as follows,

**That easement for purposes of ingress and egress and that easement for parking purposes only** stated in a warranty deed dated August 29, 1983 and recorded on September 7, 1983 as Document No. 1799145 at Volume 4896 page 7 of records of the Dane County Register of Deeds, in the City of Madison, Dane County Wisconsin

and

**That easement for purposes of ingress and egress and that easement for parking purposes only** t in a land contract dated June 6<sup>th</sup>, 1975 and recorded on June 13, 1975 as Document No. 1431784 at Volume 586 pages 134-137 of records of the Dane County Register of Deeds, in the City of Madison, Dane County Wisconsin

Do hereby release, waive, and extinguish said easements.

SIGNATURE PAGE FOLLOWS

IN WITNESS WHEREOF, SIGNED THIS \_\_\_\_\_ DAY OF \_\_\_\_\_, 2016.

Lot One Owner

\_\_\_\_\_  
Lindholm Properties 2525 University LLC by Robert J. Lindholm, manager

Lot Two Owner

\_\_\_\_\_  
Lindholm Properties 2525 University LLC by Robert J. Lindholm, manager

**ACKNOWLEDGEMENT**

STATE OF WISCONSIN            )  
Dane County                    )

Personally came before me this \_\_\_\_ day of \_\_\_\_\_, 2016 the above named Robert J. Lindholm obo Lindholm Properties 2525 University LLC to me known to be the person(s) who executed the foregoing instrument and acknowledged the same.

\_\_\_\_\_  
\*  
(Print Name)

Notary Public, State of Wisconsin My commission is permanent. (If not, state expiration date: \_\_\_\_\_)

PARCEL NUMBERS:

251/0709-211-0526-3

251/0709-211-0527-1

251/0709-211-0528-9

LEGAL DESCRIPTION

Lot 1 and Lot 2 of Certified Survey Map number 14118, recorded in Volume 95 of Certified Surveys, pages 128 - \_\_\_\_\_, as Document No. 5196318, as recorded with the Dane County Register of Deeds, in the City of Madison, Dane County, Wisconsin.

Previously described as Lot 20, 21, 22 and 23, Block 3, Map of Highland Park Plat Located in the Part of the Northwest 1/4 of the Northeast 1/4 Section 21, T7N, R9E, City of Madison, Dane County, Wisconsin.

MAP OF SHARED PARKING & INGRESS/EGRESS EASEMENT AREA

The exhibit on the following page depicts spatial relationships only.  
Viewers are advised to ignore illegible text on the map.

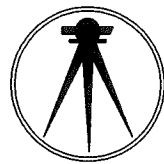

# WILLIAMSON SURVEYING & ASSOCIATES, LLC

104 A WEST MAIN STREET, WAUNAKEE, WISCONSIN, 53597.

NOA T. PRIEVE & CHRIS W. ADAMS

REGISTERED LAND SURVEYORS

PHONE: 608-255-5705 FAX: 608-849-9760 WEB: WILLIAMSONSURVEYING.COM

EXHIBIT MAP

## SHARED PARKING & INGRESS/EGRESS EASEMENT

# UNIVERSITY AVE

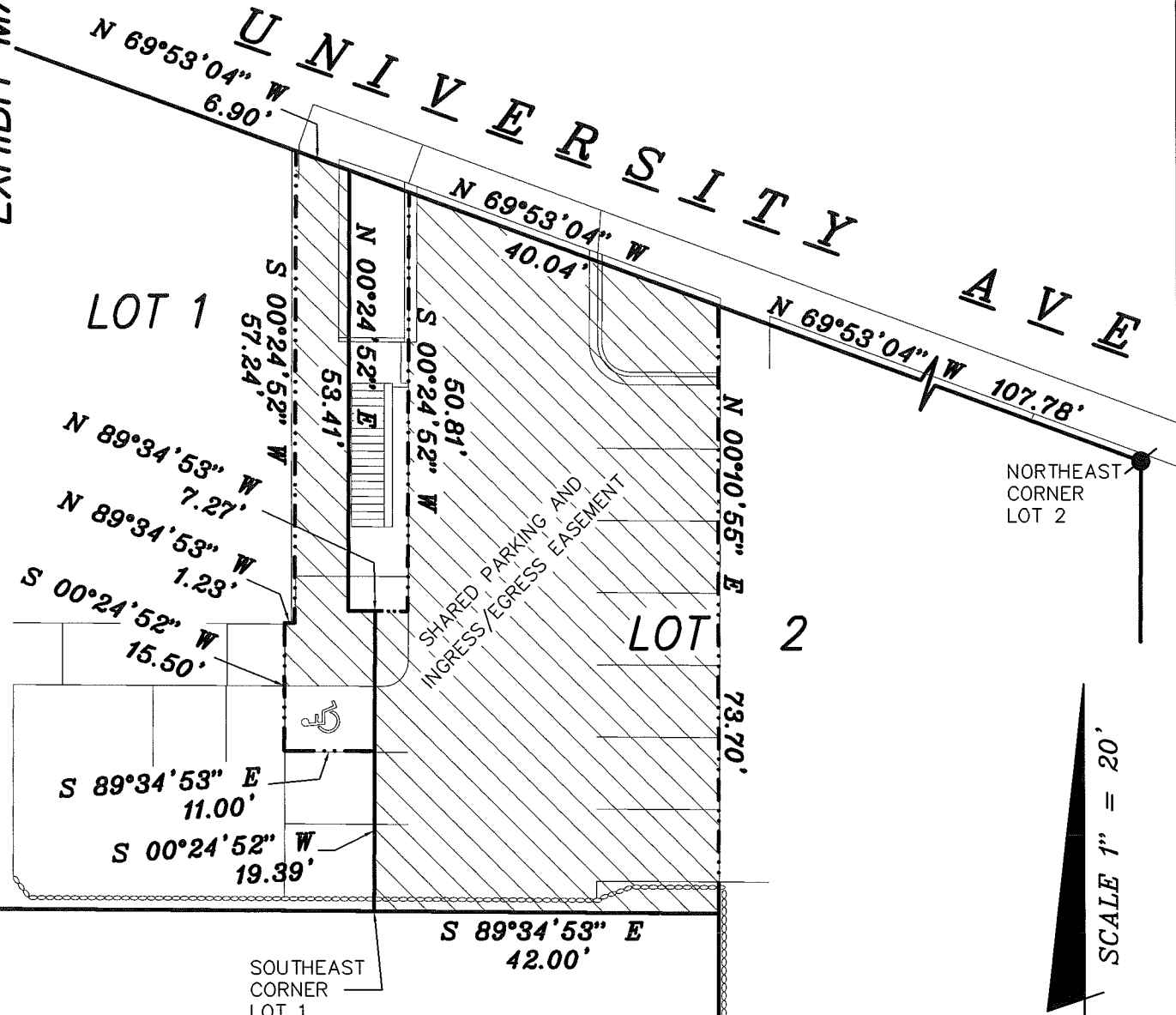

### NOTES:

1.) THIS IS NOT INTENDED TO BE A SURVEY OF THE PROPERTY LINES. THIS EXHIBIT MAP IS DONE FOR VISUAL PURPOSES IN ORDER TO CLARIFY THE DESCRIPTIONS PER THE CORRESPONDING DOCUMENTS.

JOB NO: 14W-465



QUAM ENGINEERING, LLC 4604 Siggeikow Road, Suite A; McFarland, WI 53558 (608) 838-7750 \BL-04-08\BL04BASE.DWG

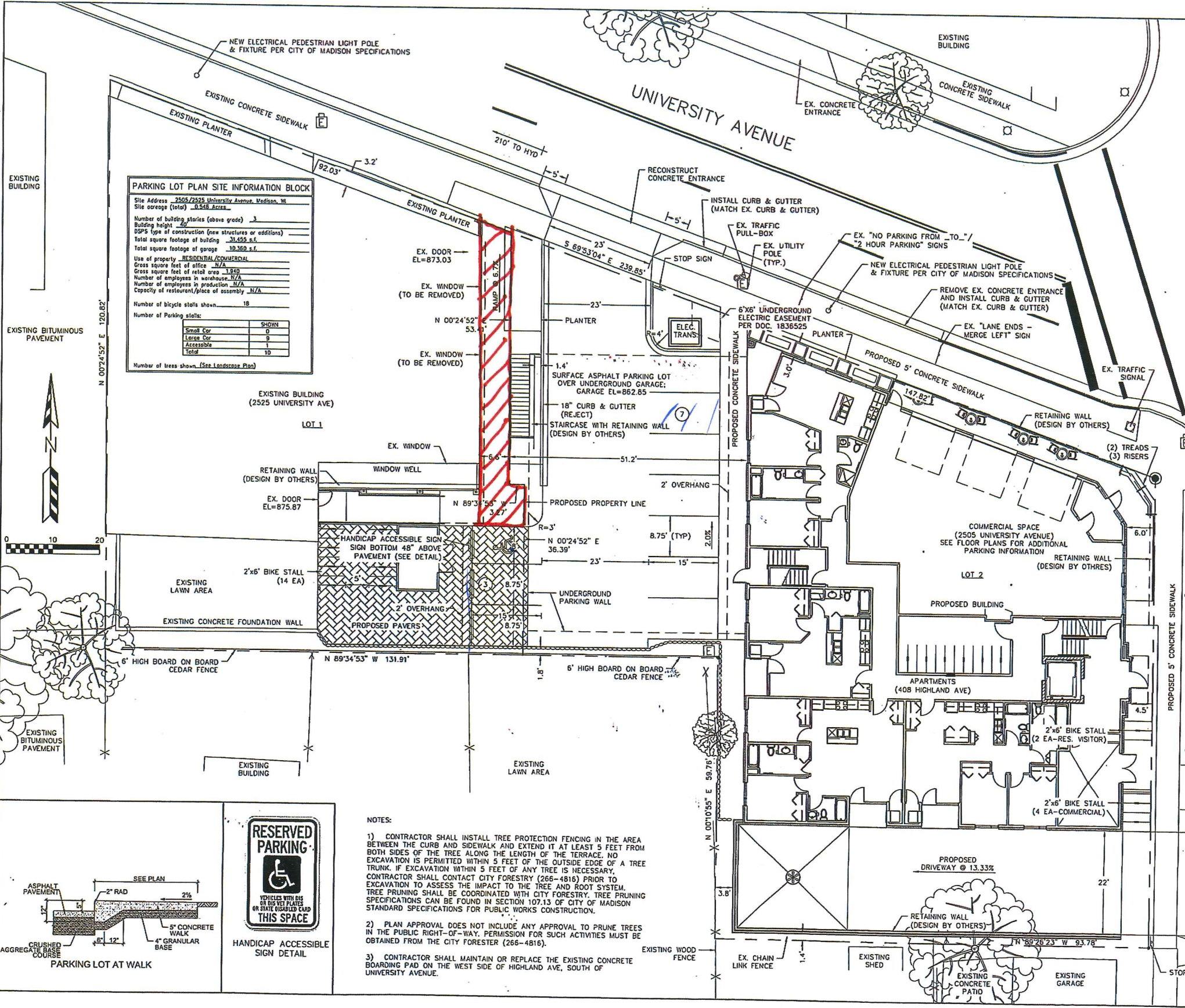

**PARKING LOT PLAN SITE INFORMATION BLOCK**

Site Address 2505/2525 University Avenue, Madison, WI  
 Site acreage (total) 0.546 Acres

Number of building stories (above grade) 3  
 Building height 40'  
 USFS type of construction (new structures or additions) \_\_\_\_\_  
 Total square footage of building 31,453 s.f.  
 Total square footage of garage 10,369 s.f.

Use of property RESIDENTIAL/COMMERCIAL  
 Gross square feet of office N/A  
 Gross square feet of retail area 1,840  
 Number of employees in warehouse N/A  
 Number of employees in production N/A  
 Capacity of restaurant/place of assembly N/A

Number of bicycle stalls shown 18

Number of Parking stalls:	SHOWN
Small Car	0
Large Car	9
Accessible	1
Total	10

Number of trees shown (See Landscape Plan)

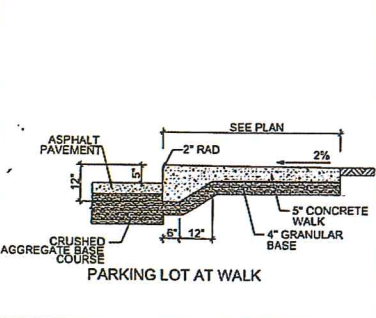

HANDICAP ACCESSIBLE SIGN DETAIL

- NOTES:**
- 1) CONTRACTOR SHALL INSTALL TREE PROTECTION FENCING IN THE AREA BETWEEN THE CURB AND SIDEWALK AND EXTEND IT AT LEAST 5 FEET FROM BOTH SIDES OF THE TREE ALONG THE LENGTH OF THE TERRACE. NO EXCAVATION IS PERMITTED WITHIN 5 FEET OF THE OUTSIDE EDGE OF A TREE TRUNK. IF EXCAVATION WITHIN 5 FEET OF ANY TREE IS NECESSARY, CONTRACTOR SHALL CONTACT CITY FORESTRY (266-4816) PRIOR TO EXCAVATION TO ASSESS THE IMPACT TO THE TREE AND ROOT SYSTEM. TREE PRUNING SHALL BE COORDINATED WITH CITY FORESTRY. TREE PRUNING SPECIFICATIONS CAN BE FOUND IN SECTION 107.13 OF CITY OF MADISON STANDARD SPECIFICATIONS FOR PUBLIC WORKS CONSTRUCTION.
  - 2) PLAN APPROVAL DOES NOT INCLUDE ANY APPROVAL TO PRUNE TREES IN THE PUBLIC RIGHT-OF-WAY. PERMISSION FOR SUCH ACTIVITIES MUST BE OBTAINED FROM THE CITY FORESTER (266-4816).
  - 3) CONTRACTOR SHALL MAINTAIN OR REPLACE THE EXISTING CONCRETE BOARDING PAD ON THE WEST SIDE OF HIGHLAND AVE, SOUTH OF UNIVERSITY AVENUE.

**OLD UNIVERSITY REDEVELOPMENT**  
 SITE PLAN  
 DATED: AUGUST 4, 2015

C1.2

**QUAM ENGINEERING, LLC**  
 Residential and Commercial Site Design Consultants

www.quamengineering.com

4604 Siggeikow Road, Suite A; McFarland, Wisconsin 53558  
 Phone (608) 838-7750; Fax (608) 838-7752

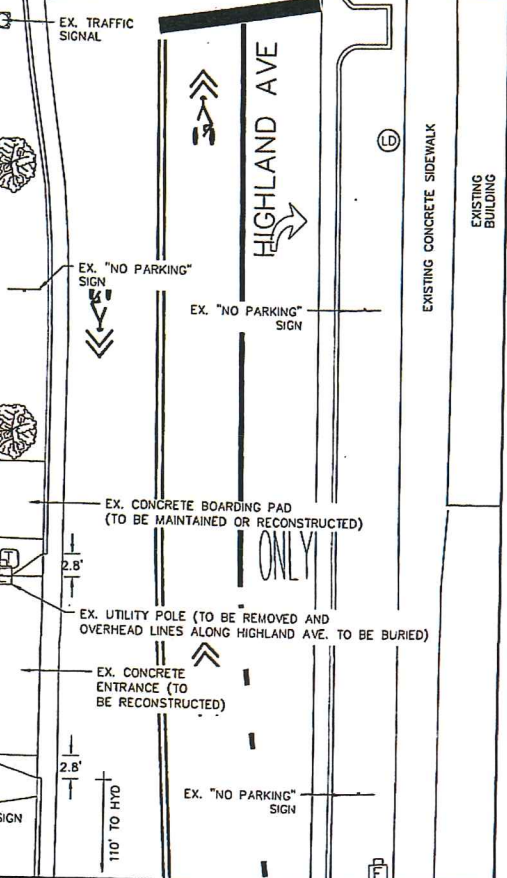
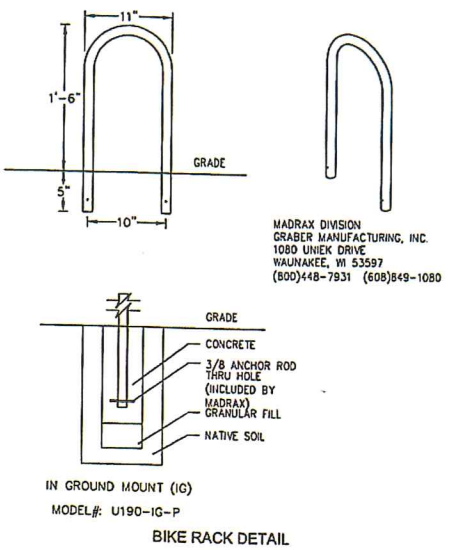



# WILLIAMSON SURVEYING & ASSOCIATES, LLC

104 A WEST MAIN STREET, WAUNAKEE, WISCONSIN, 53597.

NOA T. PRIEVE & CHRIS W. ADAMS

REGISTERED LAND SURVEYORS

PHONE: 608-255-5705 FAX: 608-849-9760 WEB: WILLIAMSONSURVEYING.COM

EXHIBIT MAP

## SHARED PARKING & INGRESS/EGRESS EASEMENT

# UNIVERSITY AVE

LOT 1

LOT 2

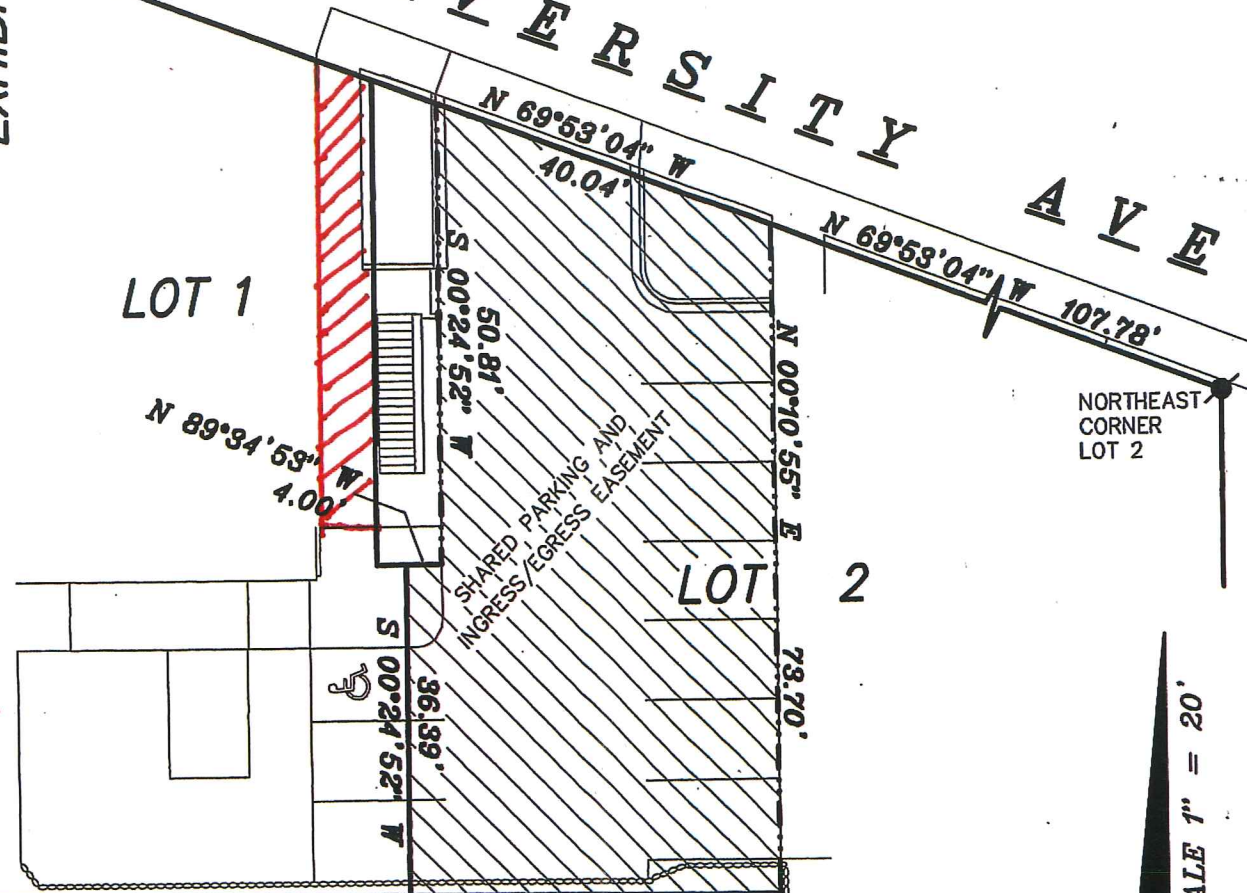

NORTHEAST CORNER LOT 2

SCALE 1" = 20'

### NOTES:

1.) THIS IS NOT INTENDED TO BE A SURVEY OF THE PROPERTY LINES. THIS EXHIBIT MAP IS DONE FOR VISUAL PURPOSES IN ORDER TO CLARIFY THE DESCRIPTIONS PER THE CORRESPONDING DOCUMENTS.

JOB NO: 14W-465

# OLD UNIVERSITY REDEVELOPMENT GRADING AND EROSION CONTROL PLAN C1.3 DATED: JULY 5, 2016

## QUAM ENGINEERING, LLC

Residential and Commercial Site Design Consultants



www.quamengineering.com  
4604 Sigelkow Road, Suite A; McFarland, Wisconsin 53558  
Phone (608) 838-7750; Fax (608) 838-7752

**EROSION NOTES:**

THE STONE TRACKING PAD SHALL BE INSTALLED PRIOR TO ANY CONSTRUCTION. THE TRACKING PAD IS TO BE MAINTAINED FOR MAXIMUM EFFECTIVENESS UNTIL VEGETATION IS ESTABLISHED. ALL EROSION CONTROL MEASURES AND STRUCTURES SERVING THE SITE MUST BE INSPECTED AT LEAST WEEKLY OR WITHIN 24 HOURS OF A 0.5 INCH RAIN EVENT. ALL MAINTENANCE WILL FOLLOW AN INSPECTION WITHIN 24 HOURS.

CUT AND FILL SLOPES SHALL BE NO GREATER THAN 3:1.

EROSION CONTROL IS THE RESPONSIBILITY OF THE CONTRACTOR UNTIL ACCEPTANCE OF THIS PROJECT. EROSION CONTROL MEASURES AS SHOWN SHALL BE THE MINIMUM PRECAUTIONS THAT WILL BE ALLOWED. THE CONTRACTOR SHALL BE RESPONSIBLE FOR RECOGNIZING AND CORRECTING ALL EROSION CONTROL PROBLEMS THAT ARE A RESULT OF CONSTRUCTION ACTIVITIES. ADDITIONAL EROSION CONTROL MEASURES, AS REQUESTED IN WRITING BY THE STATE OR LOCAL INSPECTORS, OR THE DEVELOPER'S ENGINEER, SHALL BE INSTALLED WITHIN 24 HOURS.

CONTRACTOR SHALL PROVIDE A CONCRETE MANAGEMENT AND WASHOUT PLAN TO PREVENT CONCRETE WASTE FROM ENTERING THE CITY RIGHT-OF-WAY. PLAN SHALL BE SUBMITTED TO CITY ENGINEERING FOR APPROVAL.

CONTRACTOR SHALL PROVIDE A CONSTRUCTION DEWATERING PLAN IN CONFORMANCE WITH WDRN CONSERVATION PRACTICE STANDARD 1061. PLAN SHALL BE SUBMITTED TO CITY ENGINEERING FOR APPROVAL.

**TIME SCHEDULE:**

JULY 2, 2015 - JULY 2, 2016 INSTALL EROSION CONTROL DEVICES.  
JULY 2, 2015 - JULY 2, 2016 CONSTRUCT BUILDING, PARKING LOT, DRIVEWAY, AND SIDEWALK.

**OWNER:** LINDHOLM PROPERTIES, LLC  
3801 REGENT  
MADISON, WI 53705

**ENGINEER:** QUAM ENGINEERING, LLC  
4604 SIGELKOW ROAD, SUITE A  
MCFARLAND, WI 53558

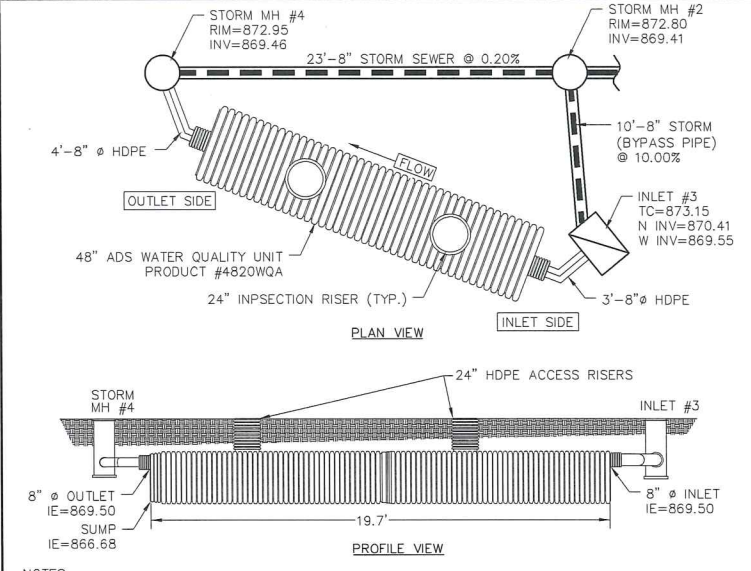

**NOTES:**

- SEE ADS STANDARD DETAILS STD-501 AND STD-504 FOR ADDITIONAL WATER QUALITY UNIT PRODUCT DETAILS.
- REFERENCE TECHNICAL NOTE 1.03 FOR ADDITIONAL DESIGN INFORMATION.

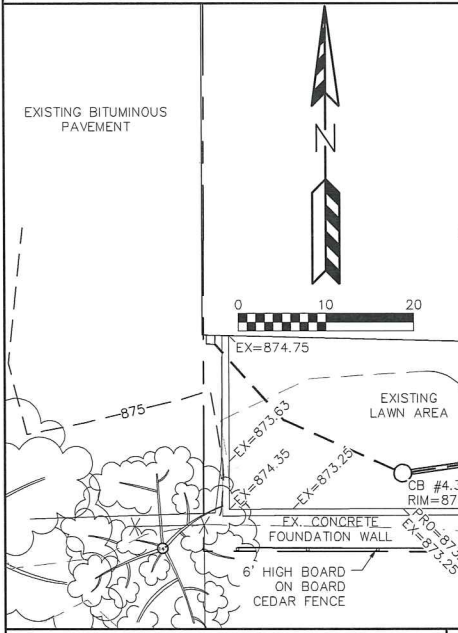
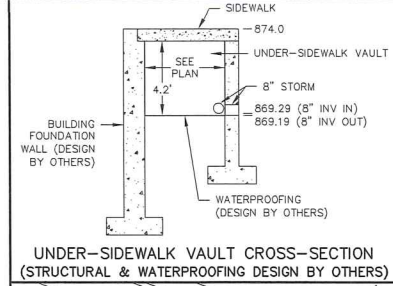

**LEGEND:**

- - 873 - - EXISTING MINOR CONTOUR.
- - 875 - - EXISTING MAJOR CONTOUR.
- - 874 - - PROPOSED MINOR CONTOUR.
- - 875 - - PROPOSED MAJOR CONTOUR.
- 872.90 - PROPOSED SPOT ELEVATION (EDGE OF PAVEMENT)
- EX=875.33 - EXISTING ELEVATION.
- ▨ - INSTALL WDOT TYPE B INLET PROTECTION.

**NOTES:**

- ALL UTILITIES ARE NOT NECESSARILY SHOWN HEREON.
- EXISTING SANITARY, STORM AND WATER MAIN ARE BASED UPON CITY OF MADISON RECORD DRAWINGS.

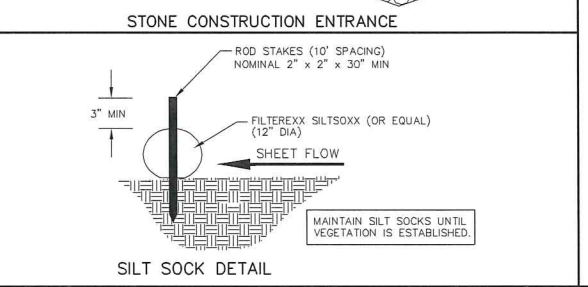
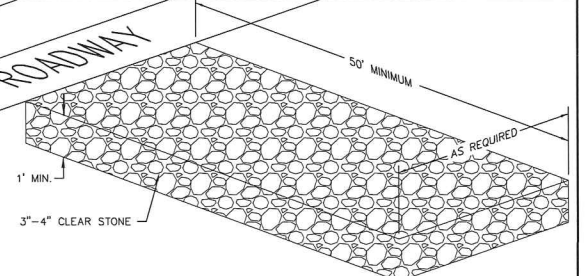

**TO OBTAIN LOCATION OF PARTICIPANTS' UNDERGROUND FACILITIES BEFORE YOU DIG IN WISCONSIN**

**CALL DIGGERS HOTLINE 1-800-242-8511 TOLL FREE**

TDD (FOR THE HEARING IMPAIRED) (800) 542-2289

WIS. STATUTE 182.0175 (1974) REQUIRES MIN. OF 3 WORK DAYS NOTICE BEFORE YOU EXCAVATE

