

FINISHED TYPICAL SECTION - STATE STREET
700 & 800 BLOCKS
(LOOKING EAST)

PLOT SCALE:

PLOT NAME:

REV. DATE:

ORIGINATOR: CITY OF MADISON, STREETS DIVISION

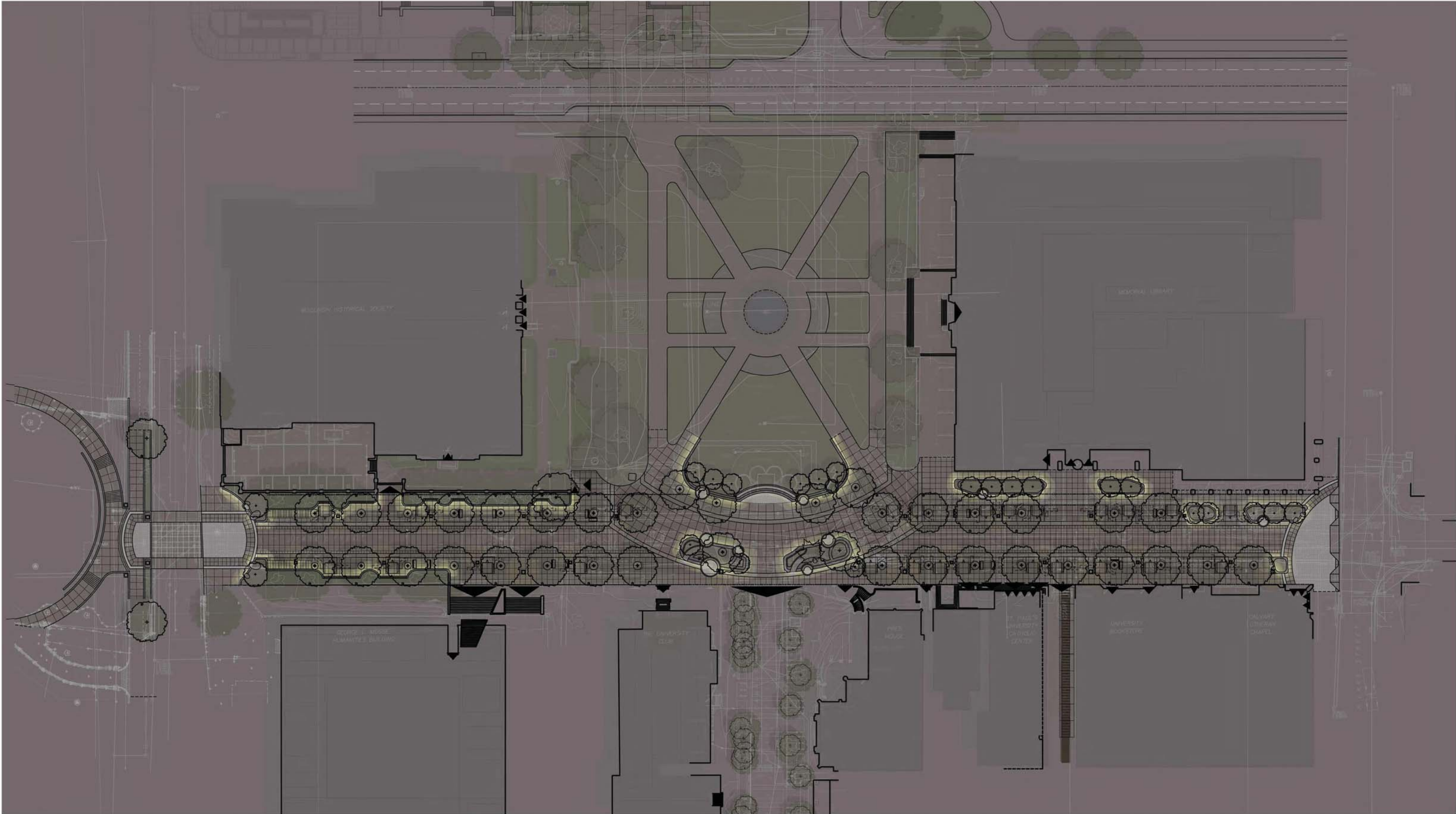

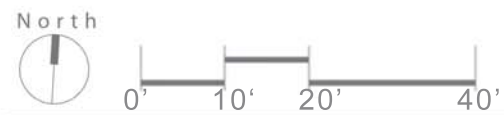
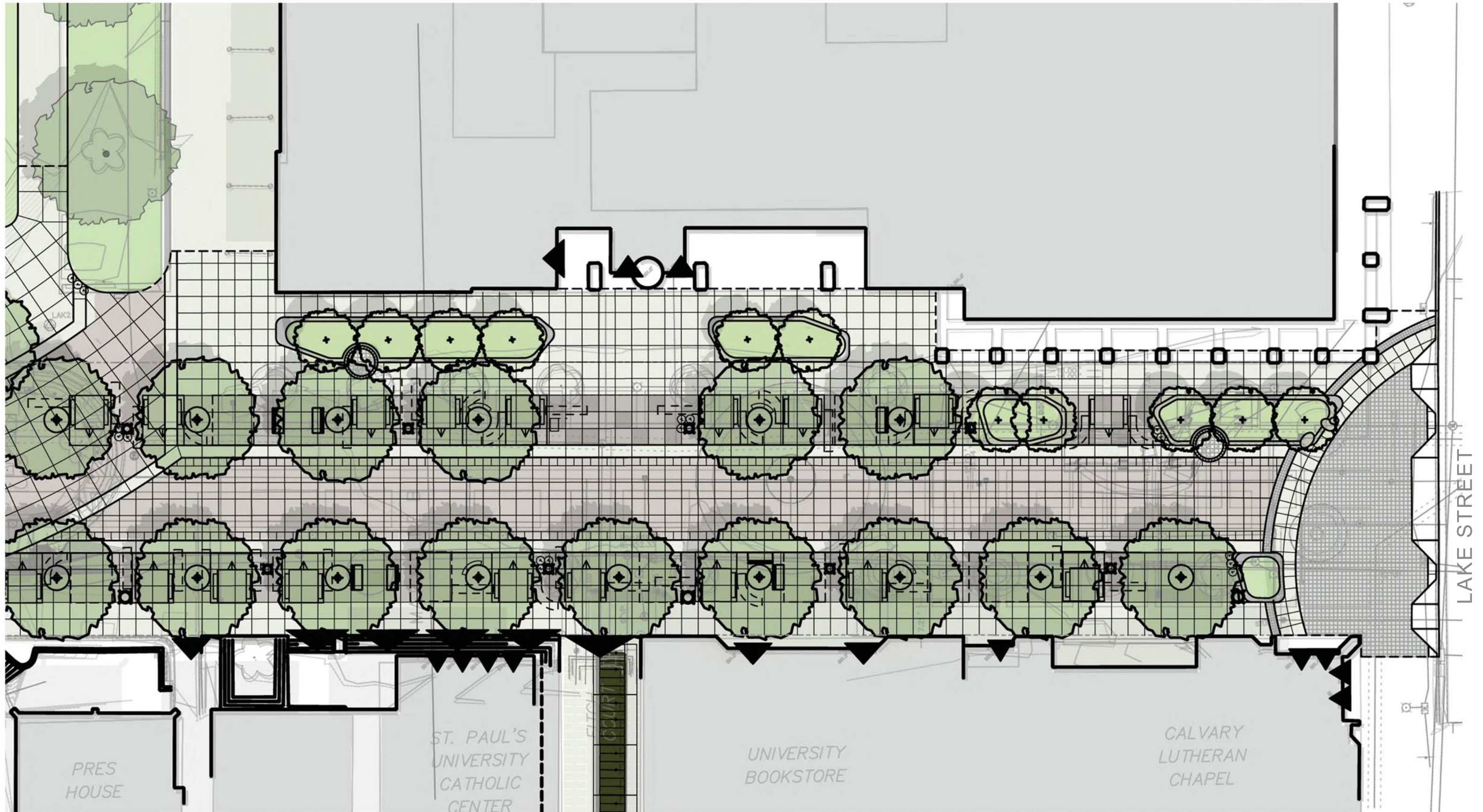

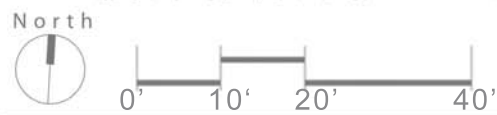
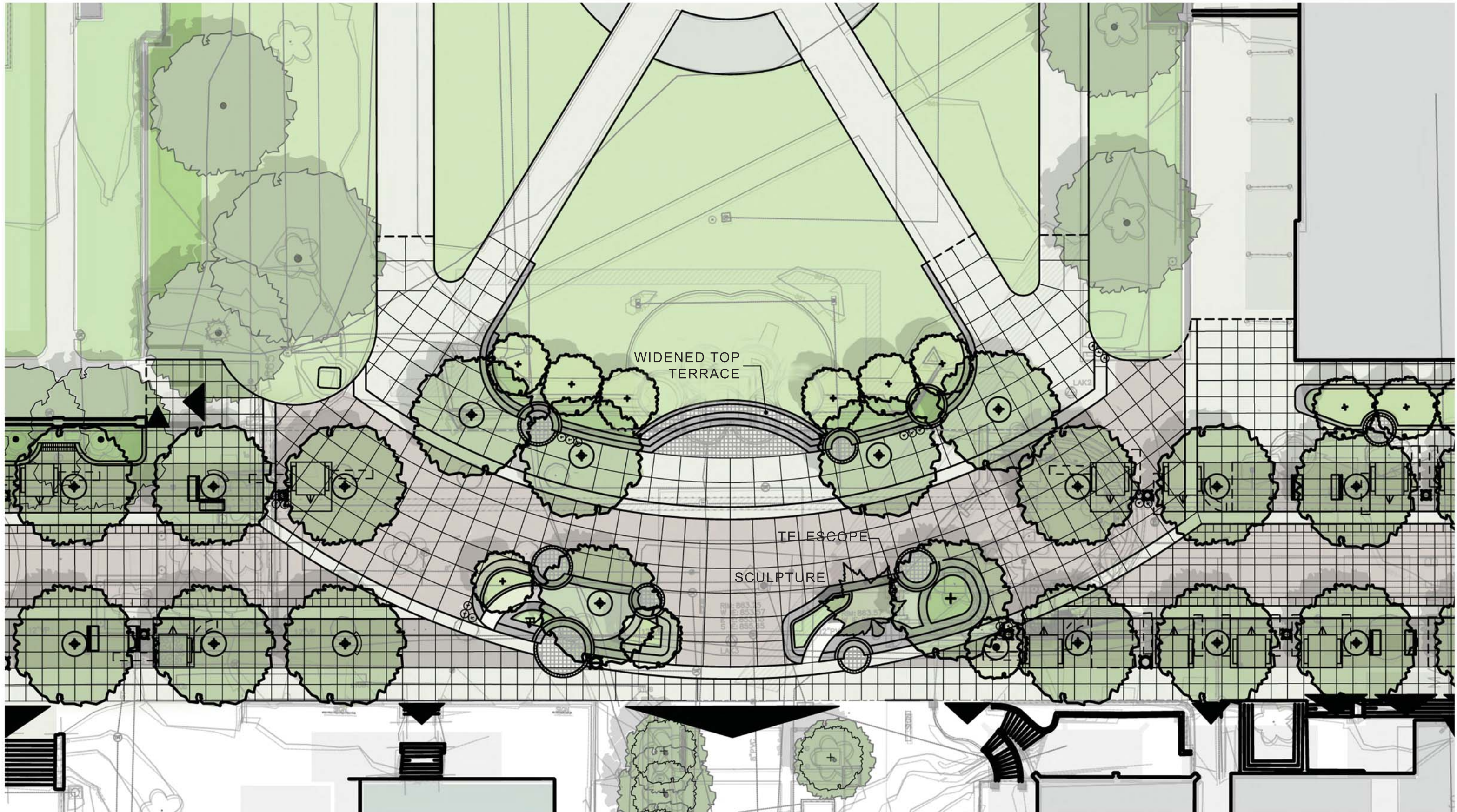

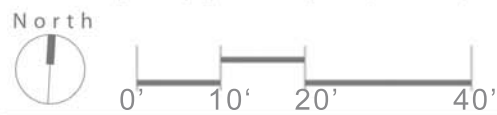
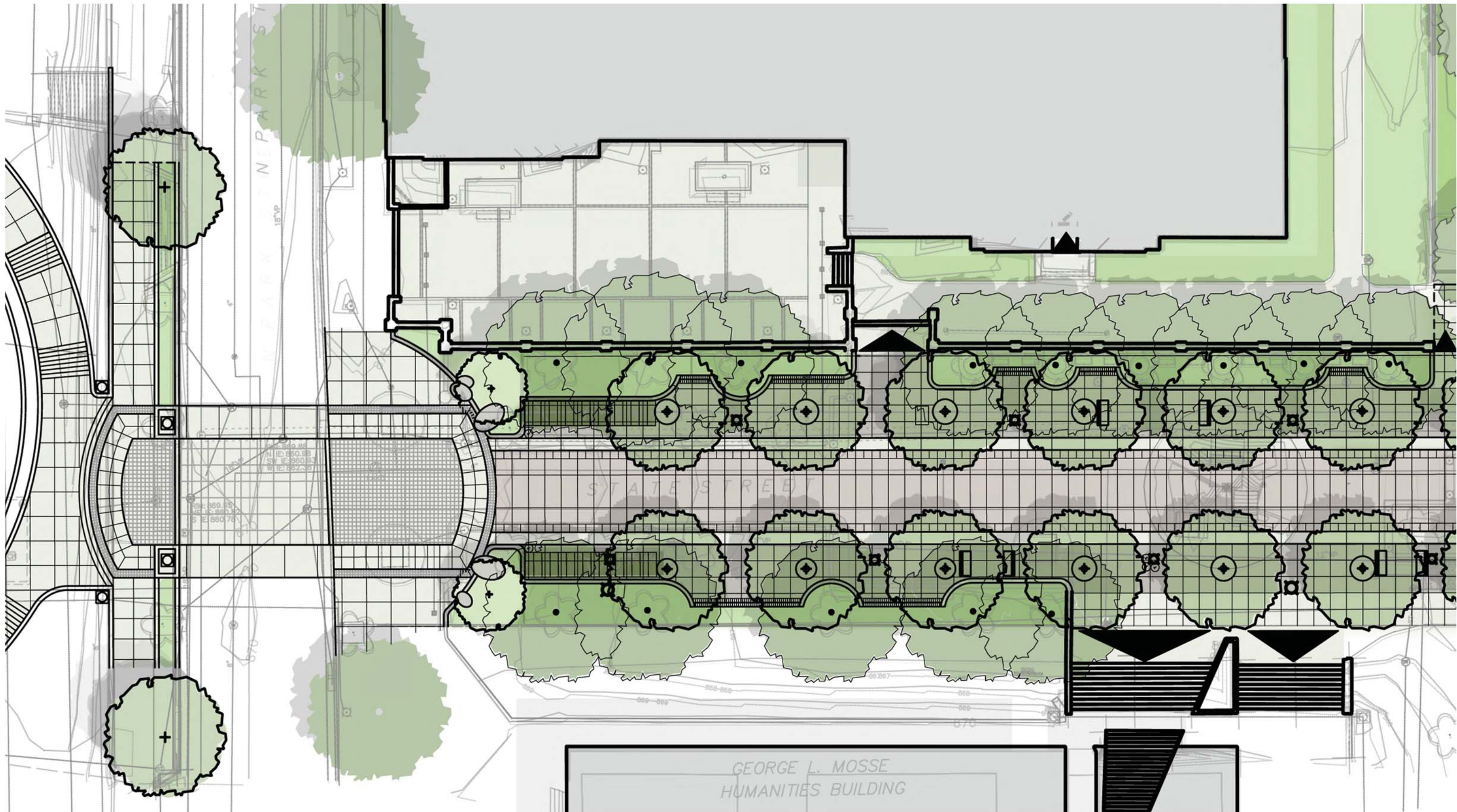

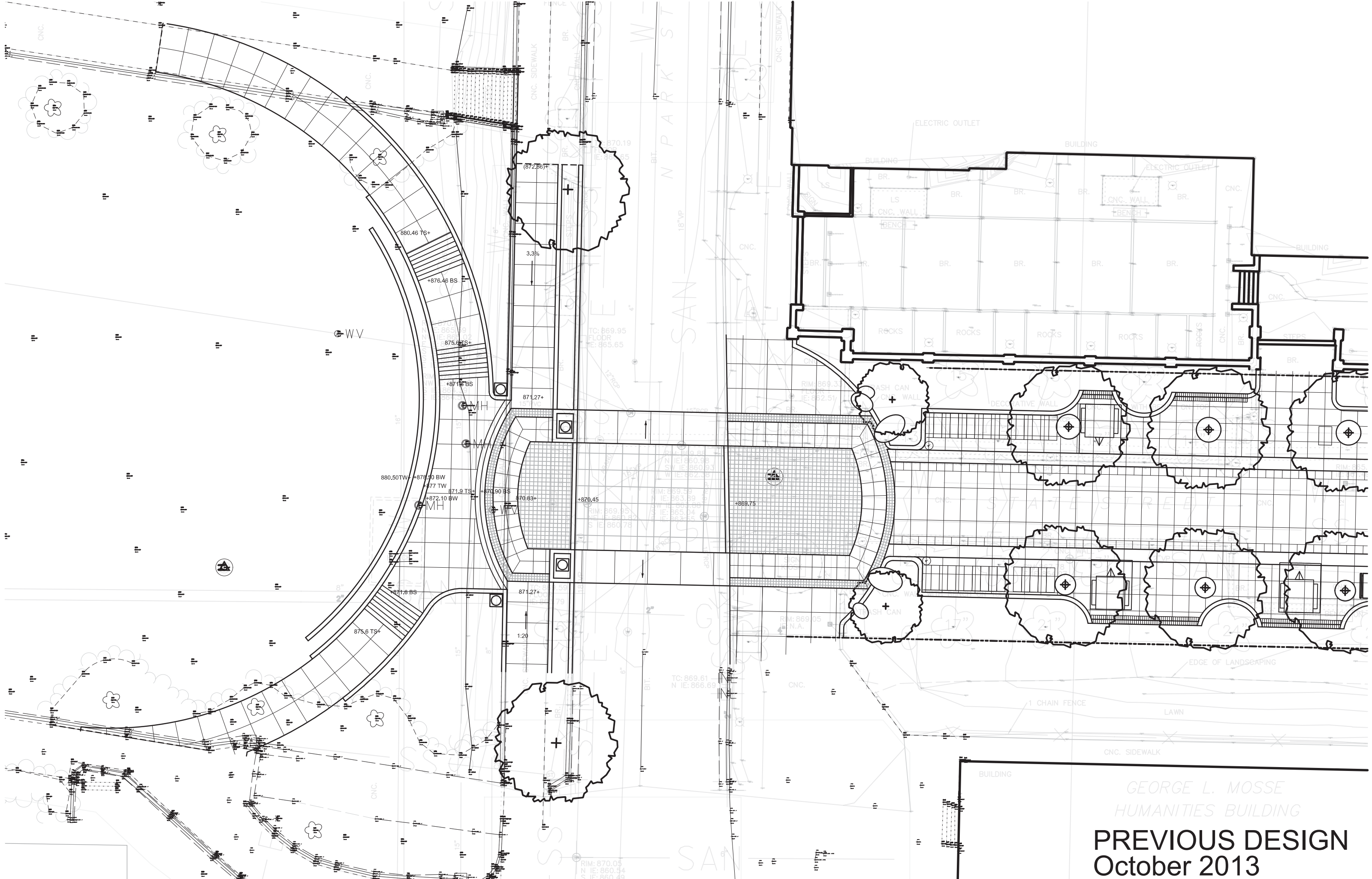

GEORGE L. MOSSE
 HUMANITIES BUILDING
PREVIOUS DESIGN
 October 2013

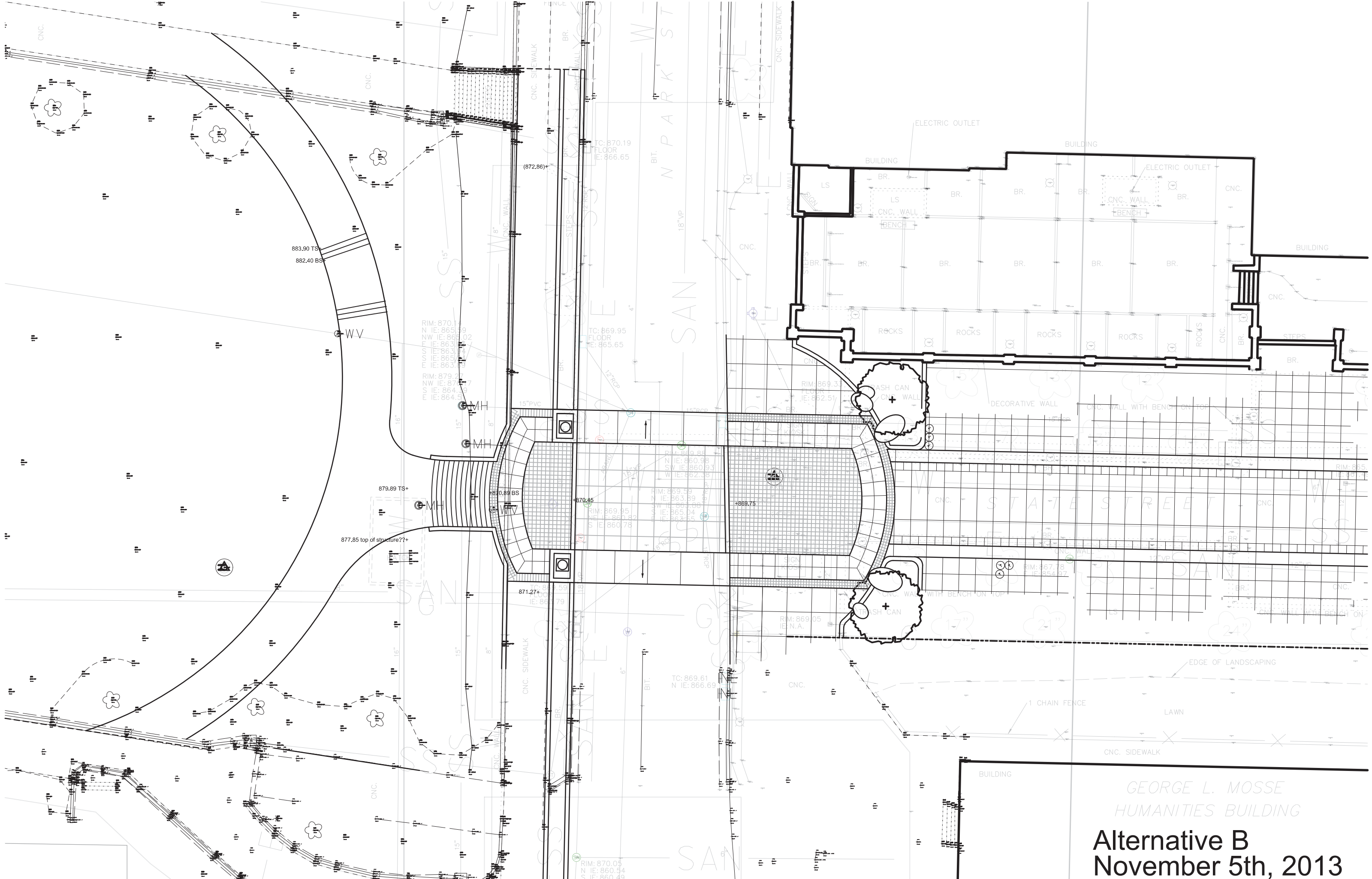

GEORGE L. MOSSE
 HUMANITIES BUILDING
Alternative B
 November 5th, 2013

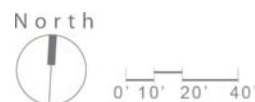
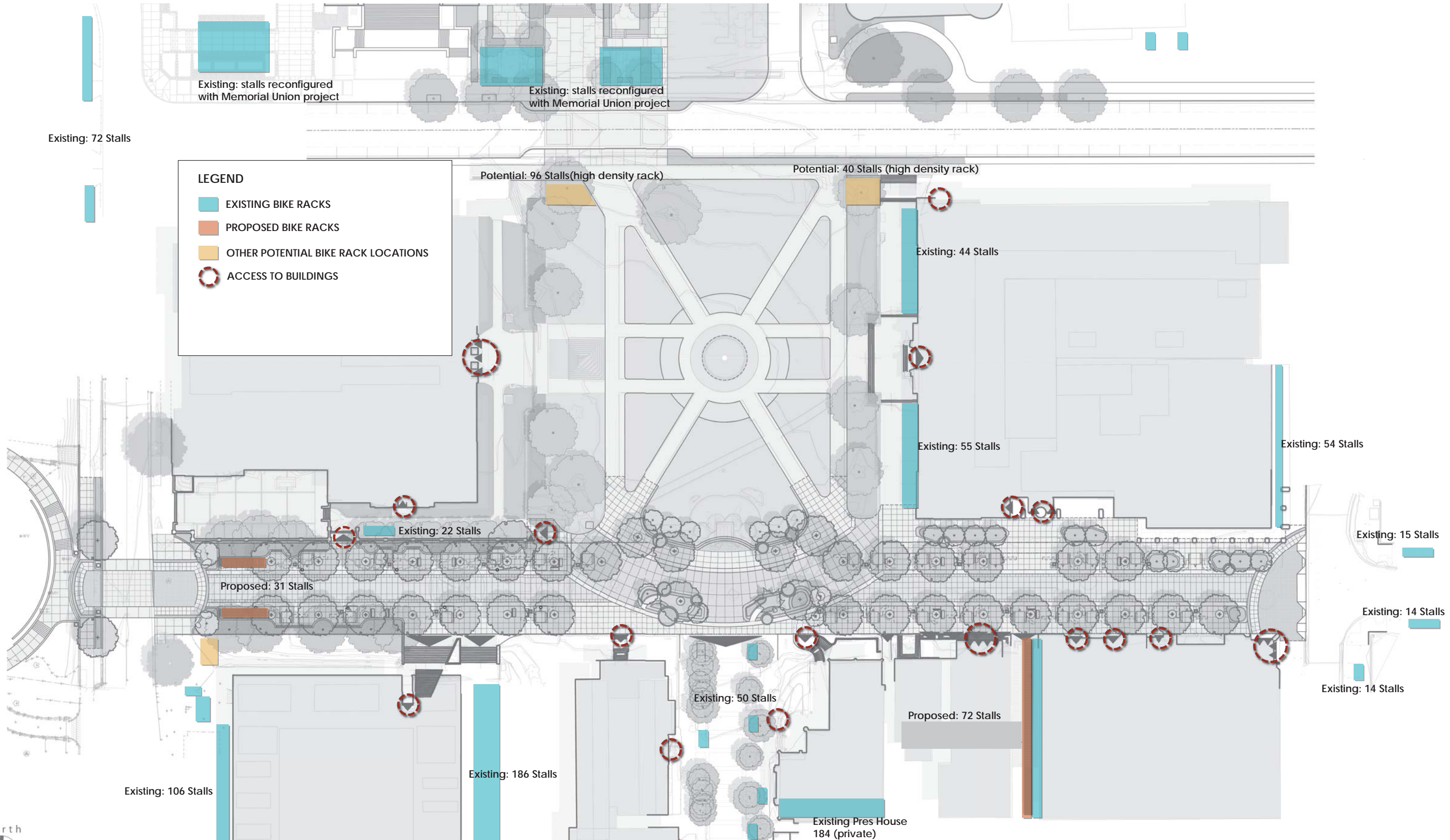

PLOT SCALE:

PLOT NAME:

REV. DATE:

ORIGINATOR: CITY OF MADISON, STREETS DIVISION

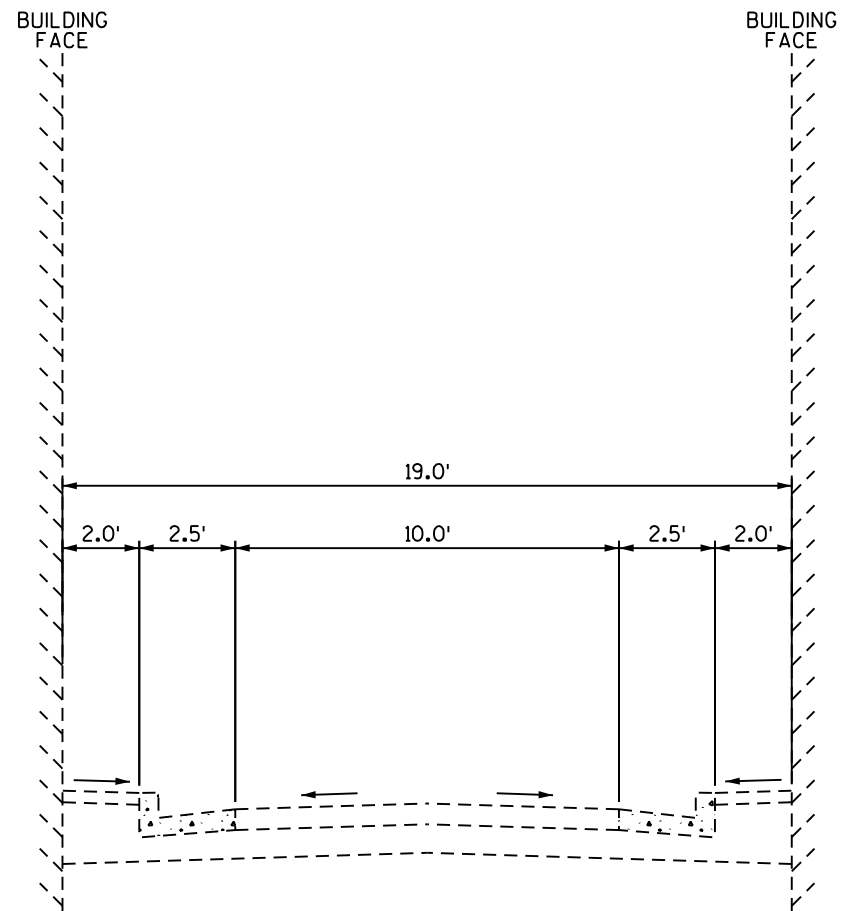

EXISTING TYPICAL SECTION - FITCH COURT
(LOOKING NORTH)

MATCH EXISTING SIDEWALK ELEVATION
AT BUILDING FACE (TYP.)

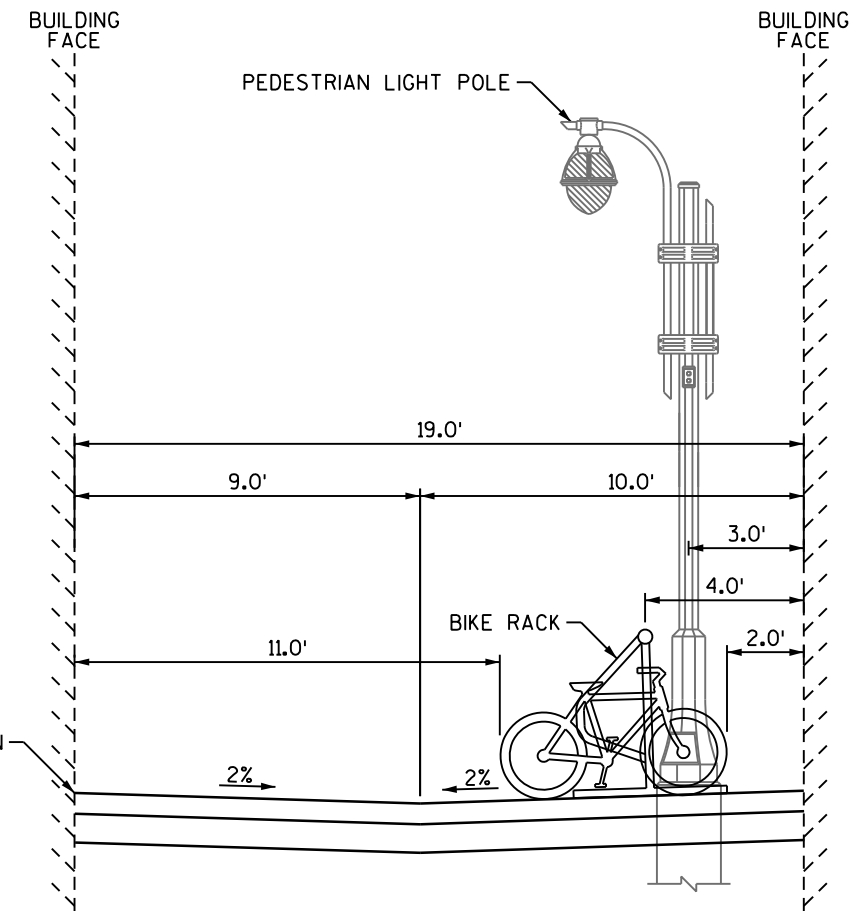

FINISHED TYPICAL SECTION - FITCH COURT
(LOOKING NORTH)



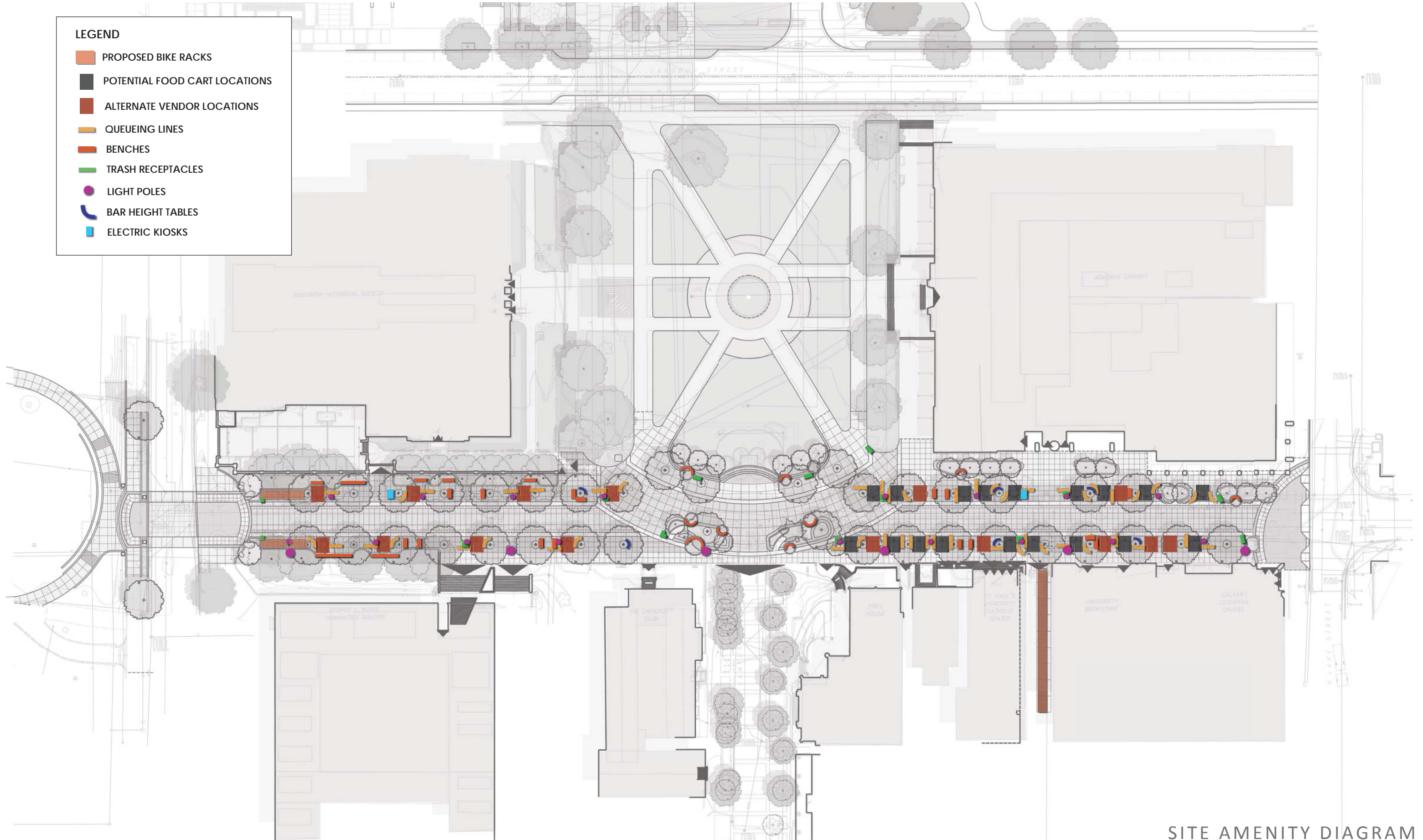

LEGEND

- PROPOSED BIKE RACKS
- POTENTIAL FOOD CART LOCATIONS
- ALTERNATE VENDOR LOCATIONS
- QUEUEING LINES
- BENCHES
- TRASH RECEPTACLES
- LIGHT POLES
- BAR HEIGHT TABLES
- ELECTRIC KIOSKS



FOOD CARTS

LEGEND

-  POTENTIAL VENDOR LOCATIONS
-  ALTERNATE VENDOR LOCATIONS
-  QUEUE LINES

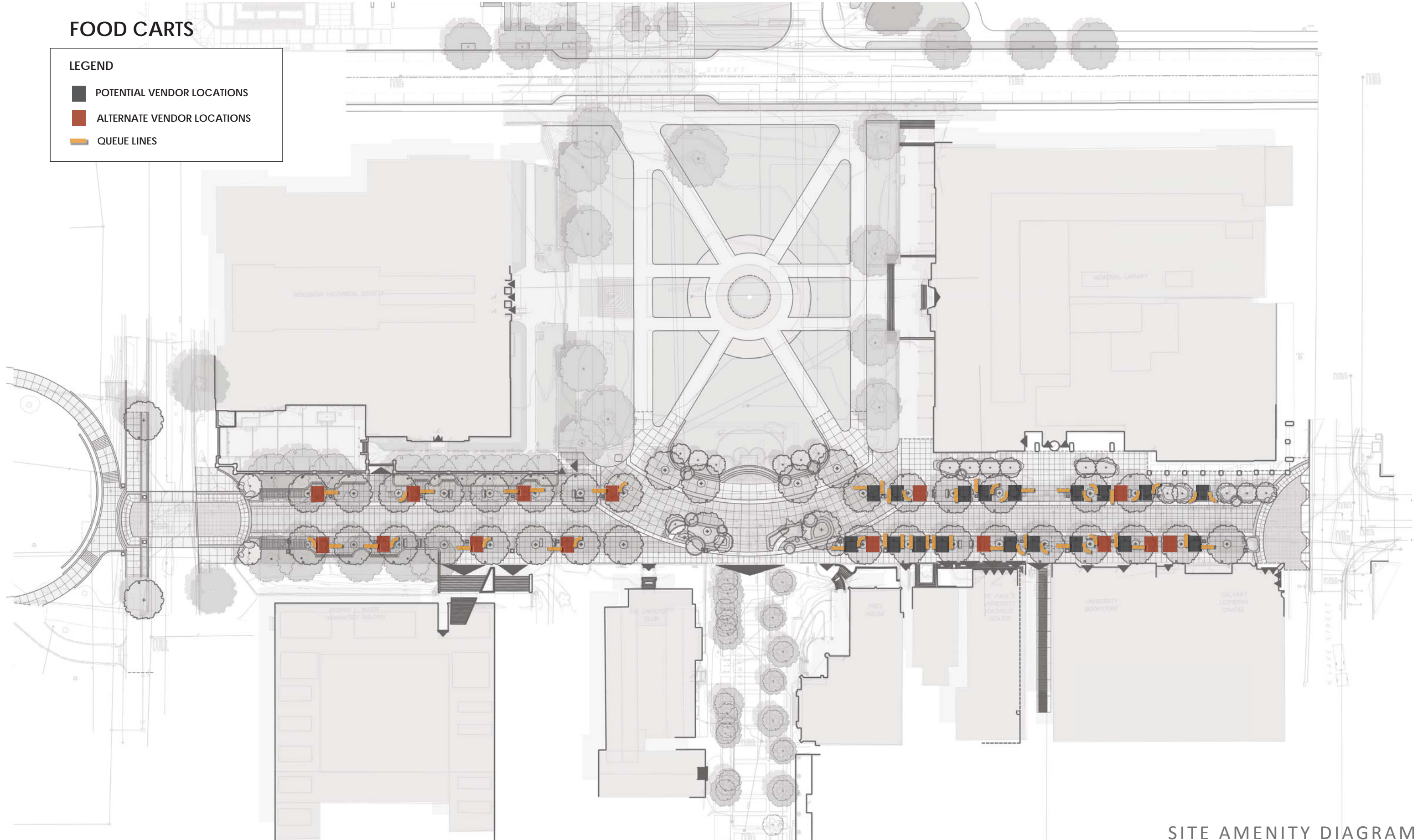

BENCHES

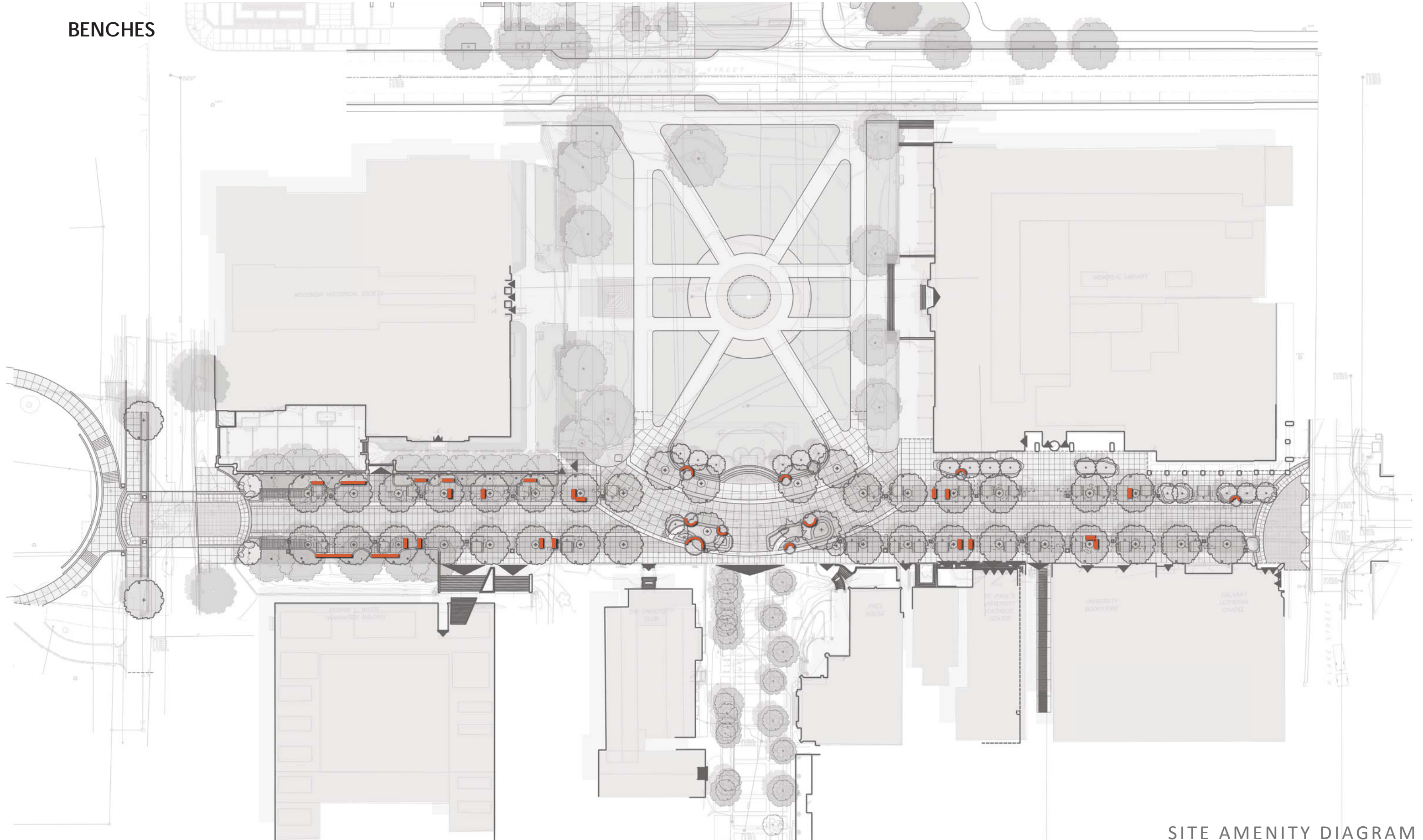

LIGHT POLES

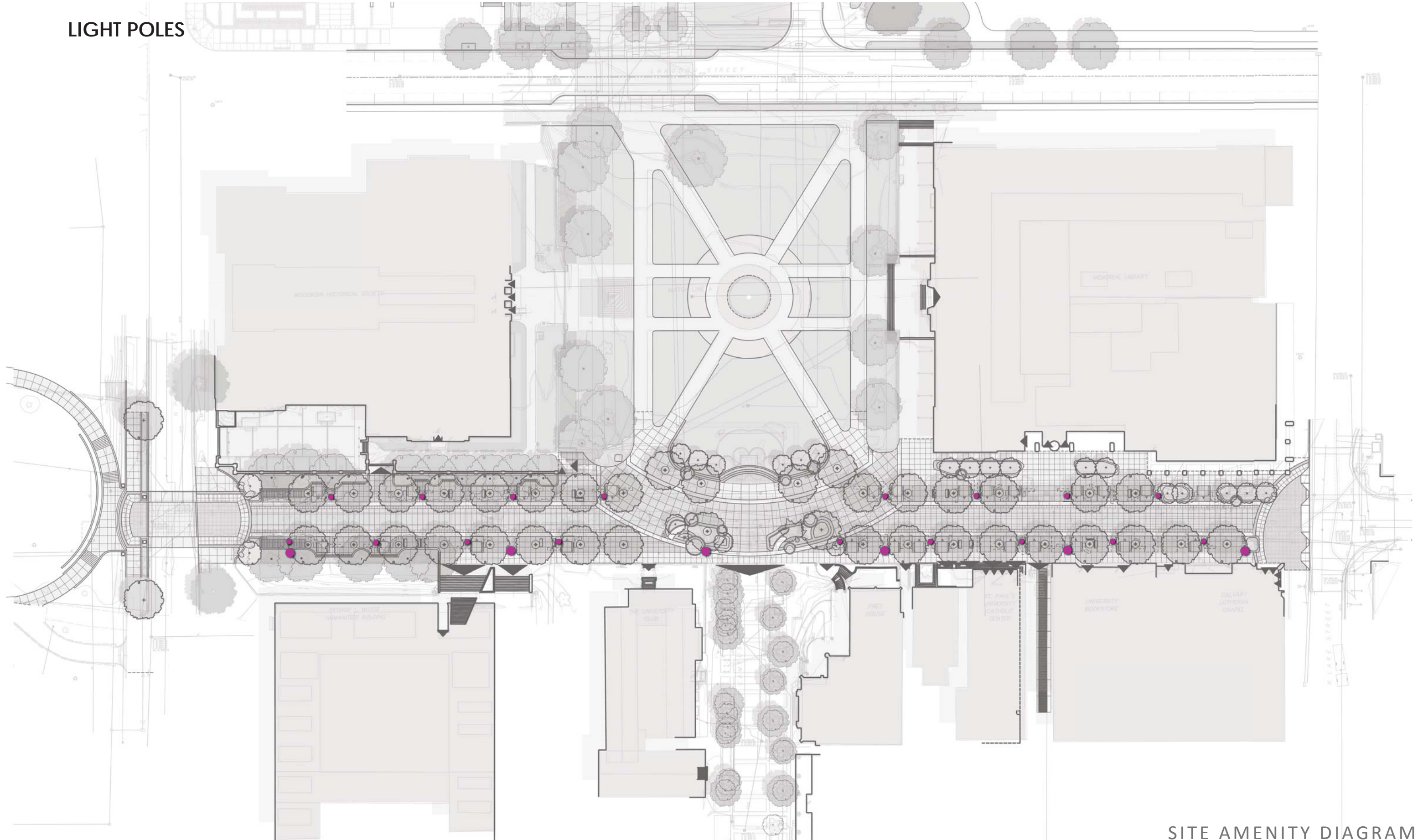

BAR HEIGHT TABLES

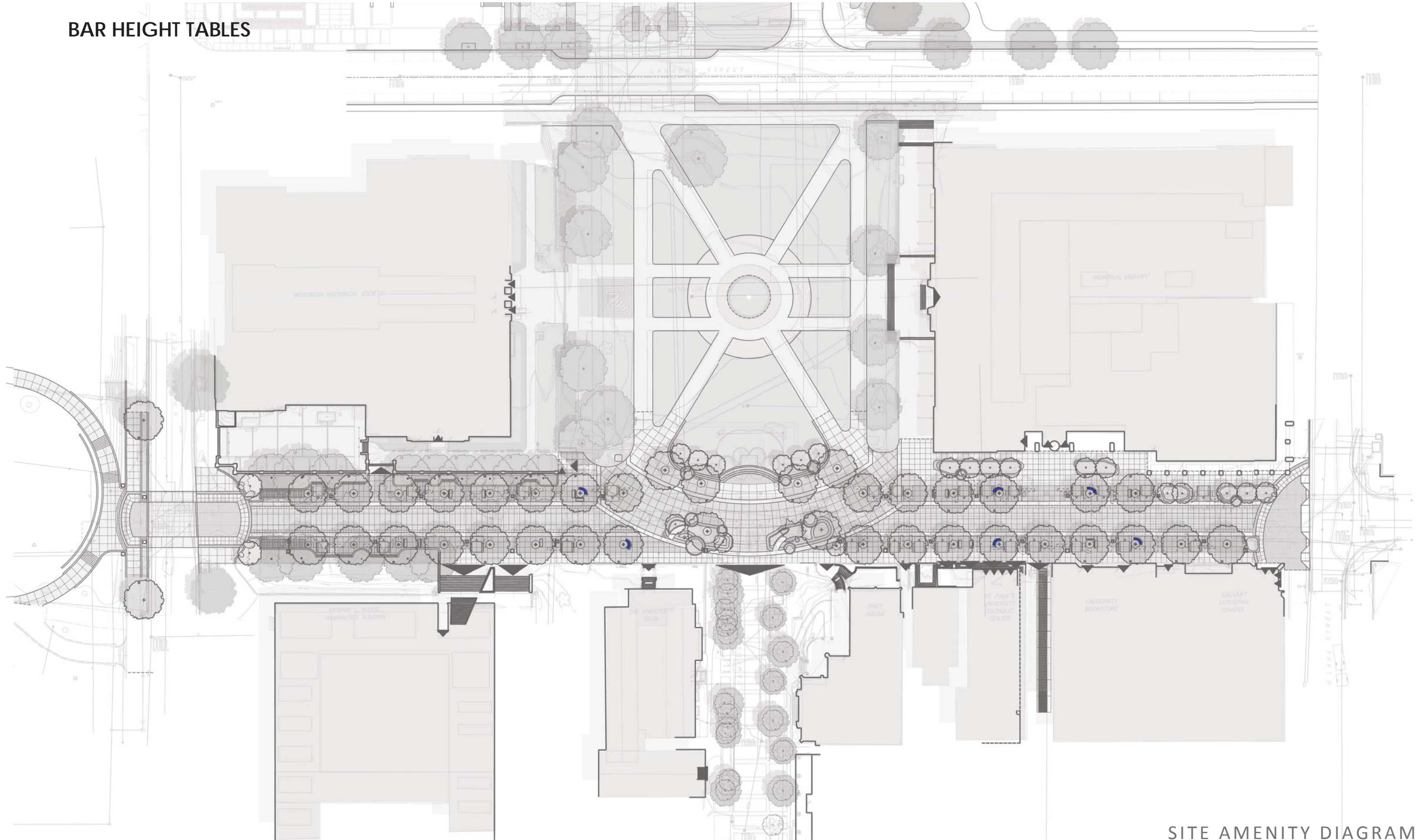

ELECTRIC KIOSKS

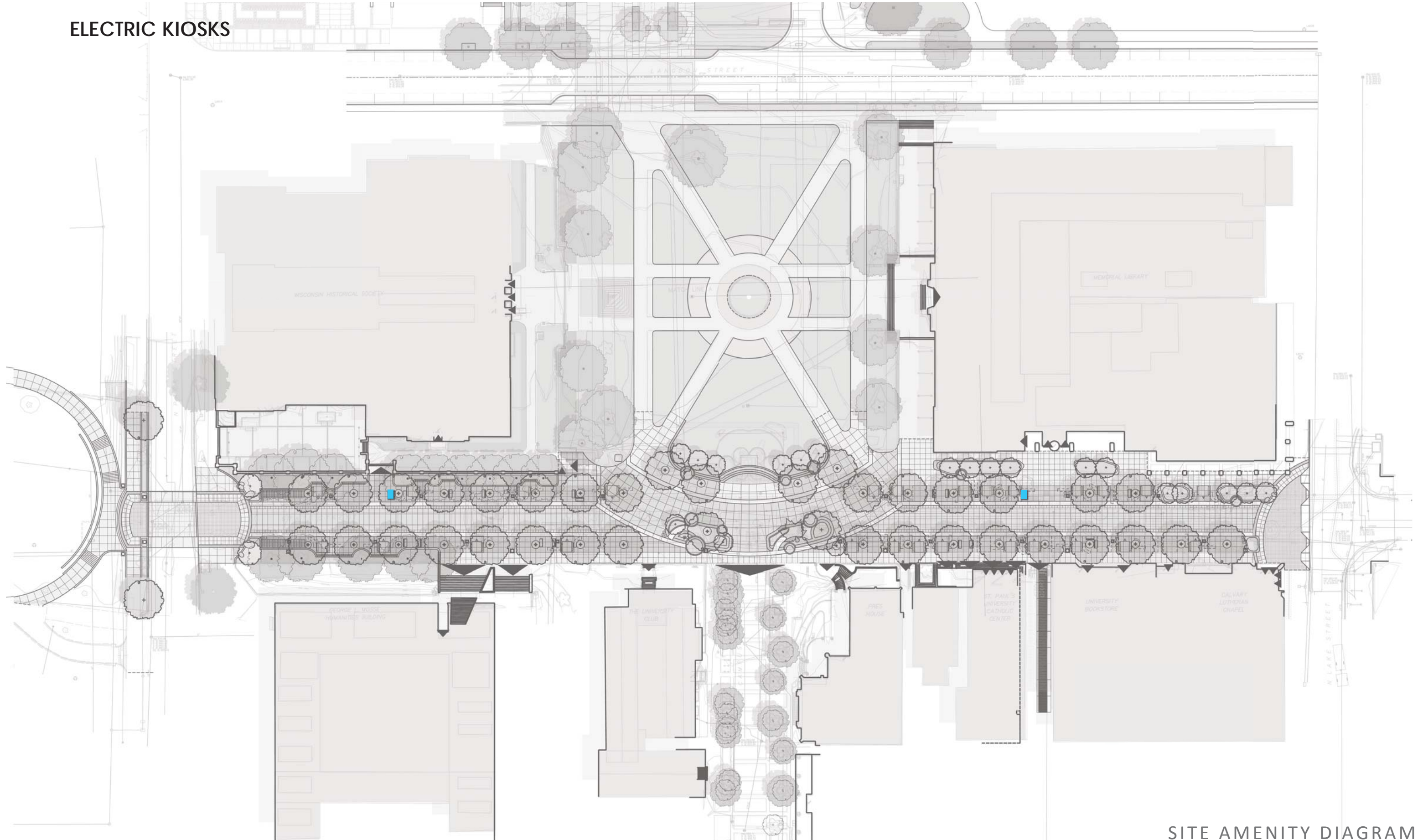

TRASH RECEPTACLES

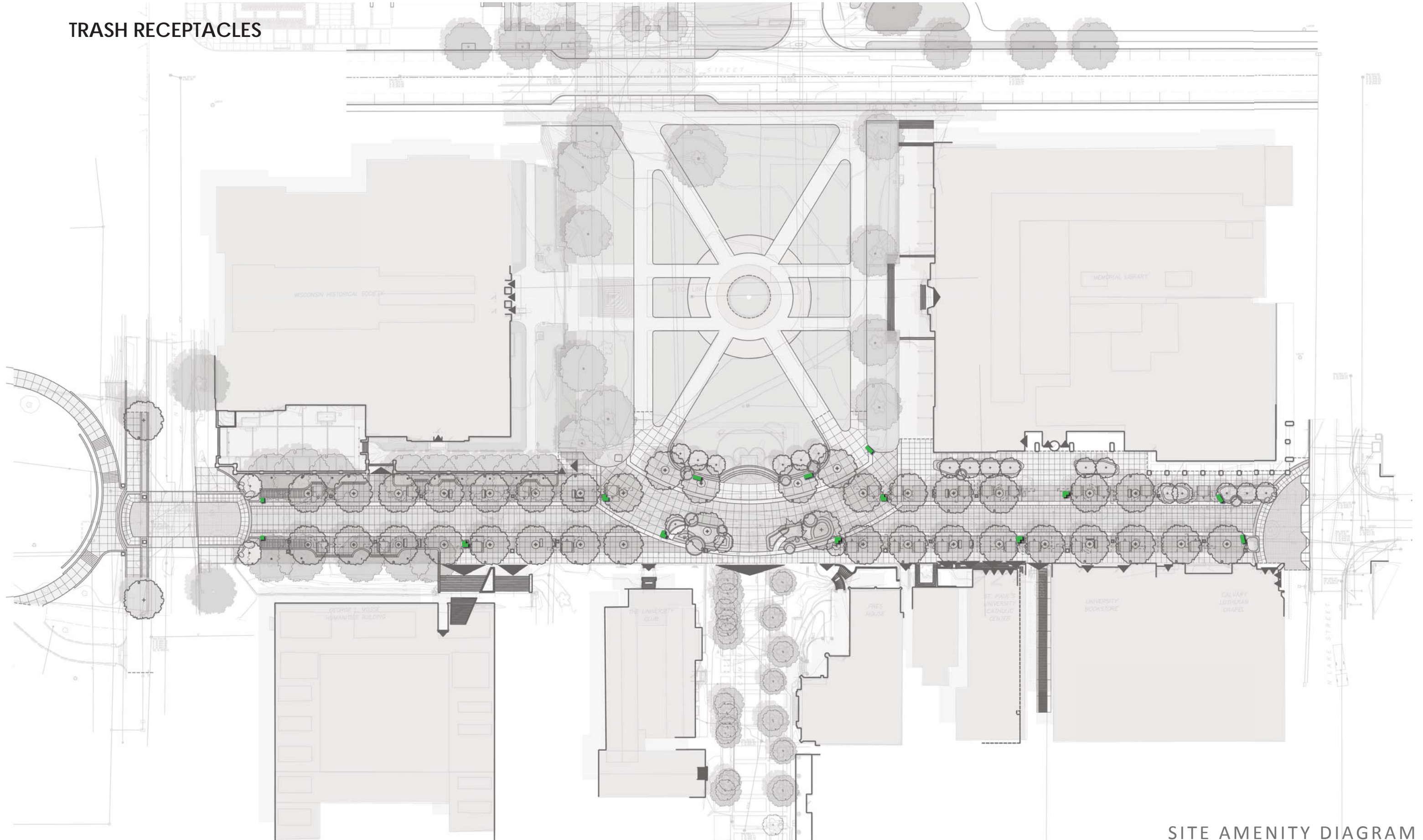

STATE STREET SITE FURNITURE: BLACK POWDERCOAT ON STEEL



Bike racks



State Street light fixtures

MOVABLE TABLES AND CHAIRS



Semi-fixed benches



Light poles



Trash receptacles

PAVING MATERIALS



State Street Granite Pavers



State Street C1 Concrete - Exposed Aggregate



Aggregate

COLORED CONCRETE



CONCRETE FINSHES



Sand blasted



Brushed



Sand blasted

Brushed colored concrete

