

APPLICATION FOR
URBAN DESIGN COMMISSION
REVIEW AND APPROVAL

AGENDA ITEM # _____
Project # _____
Legistar # _____

DATE SUBMITTED: <u>4.3.12</u>	Action Requested
UDC MEETING DATE: <u>4.18.12</u>	<input type="checkbox"/> Informational Presentation
	<input checked="" type="checkbox"/> Initial Approval and/or Recommendation
	<input type="checkbox"/> Final Approval and/or Recommendation

PLEASE PRINT!

PLEASE PRINT!

PROJECT ADDRESS: 801 SOUTH PARK STREET

ALDERMANIC DISTRICT: ELLINGTON #13

OWNER/DEVELOPER (Partners and/or Principals)	ARCHITECT/DESIGNER/OR AGENT:
<u>PAT MCCAGHER - ERIN SQUARE LLC</u>	<u>JOHN BIENO - TJK DESIGN BUILD</u>
<u>1016 WEST WASHINGTON AVE - TRAIN CAR 'D'</u>	<u>634 WEST MAIN STREET</u>
<u>MADISON, WI 53703</u>	<u>MADISON, WI 53703</u>

CONTACT PERSON: JOHN BIENO - TJK DESIGN BUILD

Address: 634 WEST MAIN STREET
MADISON, WI 53703

Phone: 608 257 1690

Fax: 608 257 1692

E-mail address: JBIENO@TJKDESIGNBUILD.COM

TYPE OF PROJECT:
(See Section A for:)

- Planned Unit Development (PUD)
- General Development Plan (GDP)
- Specific Implementation Plan (SIP)
- Planned Community Development (PCD)
- General Development Plan (GDP)
- Specific Implementation Plan (SIP)
- Planned Residential Development (PRD)
- New Construction or Exterior Remodeling in an Urban Design District * (A public hearing is required as well as a fee)
- School, Public Building or Space (Fee may be required)
- New Construction or Addition to or Remodeling of a Retail, Hotel or Motel Building Exceeding 40,000 Sq. Ft.
- Planned Commercial Site

(See Section B for:)

- New Construction or Exterior Remodeling in C4 District (Fee required)

(See Section C for:)

- R.P.S.M. Parking Variance (Fee required)

(See Section D for:)

- Comprehensive Design Review* (Fee required)
- Street Graphics Variance* (Fee required)
- Other _____

*Public Hearing Required (Submission Deadline 3 Weeks in Advance of Meeting Date)

Where fees are required (as noted above) they apply with the first submittal for either initial or final approval of a project.

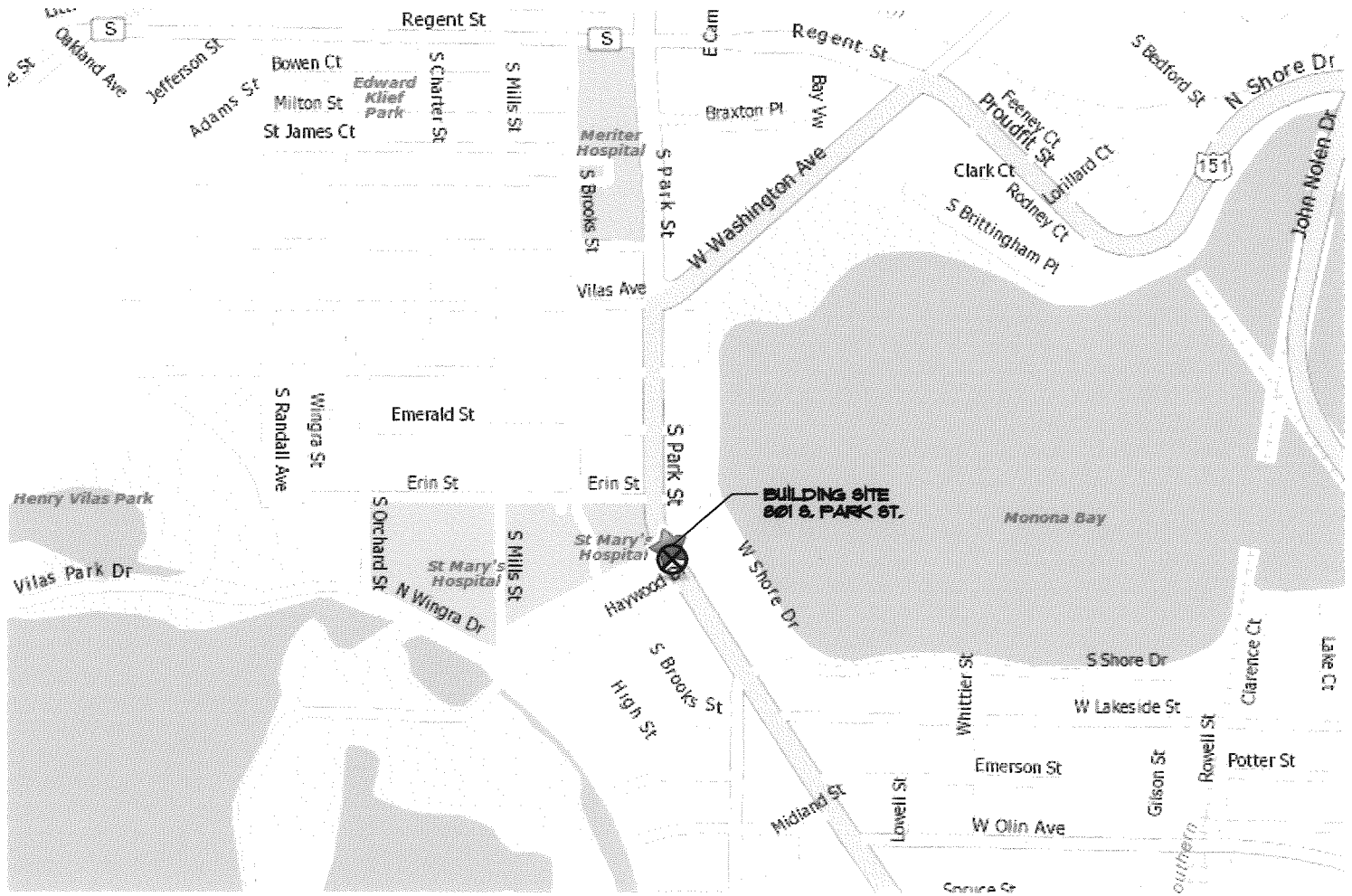

SITE LOCATION MAP

801 SOUTH PARK STREET

DATE: 4.3.12

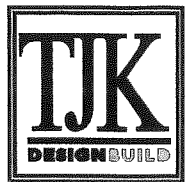

ZONING TEXT

April 3, 2012

Erin Square

801 South Park Street
Madison, WI

Legal Description

Plat of West Bay, Lots 1, 2 & 3 Except That PT Conveyed To The State Of Wisc In Vol 501, Page 141, Recorded 8/5/1947 As Doc 749554 & Re-Recorded 12/5/1947 Vol 507 Page 249 Doc 756494. Also Except That PT Conveyed To The City of Madison, Vol 431 Page 562, Recorded 4/20/1973 as Doc 1361810, Lot 4, West Bay, Except That Part Conveyed to State of Wisc in Vol 508, Page 139, Recorded 12/27/1947 as Doc 757491. Also Except That Part Conveyed to City of Madison as Vol 417, Page 306, Recorded 2/23/1973 as Doc 1355952. Lot 5, West Bay, Except That Part Conveyed to the State of Wisconsin, Vol 500, Page 512, Recorded 7/29/1947 as Doc 749155.

Statement of Purpose

This Zoning District is established to allow for the construction of a mixed use development with 7 dwelling units, approximately 3,300 s.f. of commercial space and 14 surface parking stalls.

Permitted Uses

- Residential uses as allowed in the R-2 district pursuant to Chapter 2803 (2) of the Madison General Ordinance.
- Commercial uses as listed in Exhibit A
- Accessory uses to the above uses, including but not limited to accessory parking and home occupations as defined in Chapter 28 of the Madison General Ordinances.

Lot Area

As shown on approved plans

Building Bulk and Placement

- Floor area ratio is shown on approved plans.
- Building height is shown on approved plans.
- Yard area will be provided as shown on approved plans.

Landscaping

- Site and planter landscaping will be provided as shown on approved plans.

Parking Management

- Surface parking is for residents guest, employees and customers of the development. Overnight parking will only be permitted with prior approval from the landlord.
- Accessory off street parking and loading will be provided as shown on approved plans.

Trash Removal

- Trash removal will be provided by private contractor. It is the tenant responsibility to transport garbage from unit/rental space to enclosed trash area outside of building. Collections from landlord trash area will be on a regular scheduled basis.

Snow Removal

- Snow removal will be provided by private contractor. Small events and snow accumulation will be handled on site. Determination of snow removal schedule is the responsibility of the landlord. Accumulation exceeding the capacity of the site will be hauled away.

Lighting

- Site lighting will be provided and shown on approved plans.

Signage

- Signage shall be allowed as per Chapter 31 of the Madison General Ordinances, as compared to the C2 Zoning District. Signage shall be approved by the Urban Design Commission. Sign permits must be issued by the Zoning Section of the Department of Planning and Community and Economic Development prior to sign installations. Signage will be allowed as recorded on the approved plans and Exhibit E.

Alterations and Revisions

No alteration or revision of this planned unit development shall be permitted unless approved by the City Plan Commission, however, the Zoning Administrator may issue permits for minor alterations or additions which are approved by the Director of Planning and Development and the alderperson of the district and are compatible with the concept approved by the City Plan Commission.

EXHIBIT A

List of permitted uses for Floor 1, the commercial portion, of building
(permitted residential uses are residential units on Floors 3 and 4, as shown on approved plans)

1. Administrative offices.
2. Adult day care facilities.
3. Antique Shops.
4. Art and school supply stores.
5. Art galleries and museums.
6. Auction rooms.
7. Artisan Studios.
8. Automobile accessory stores.
9. Banks and financial institutions.
10. Barbershops and Beauty parlors.
11. Bedding Sales.
12. Bicycle sales, rental and repair establishments.
13. Blueprinting and Photostatting establishments.
14. Book, magazine and stationery stores.
15. Business machine sales and service establishments.
16. Camera and photographic supply stores.
17. Candy and ice cream stores.
18. Card and gift shops.
19. Carpet and rug stores.
20. Catering establishments.
21. China and glassware stores.
22. Clothing and costume rental stores.
23. Coin and philatelic stores.
24. Contractors or construction offices and shops and display rooms.
25. Data processing centers.
26. Department stores.
27. Drugstores.
28. Dry good stores.
29. Educational or training centers.
30. Electronic stores, including the sale and service of computer, audio, radio, telecommunications and television – video equipment and accessories.
31. Employment agencies.
32. Exterminating shops.
33. Express and parcel delivery establishments.
34. Floor covering stores (linoleum and tile).
35. Florist shops and conservatories.
36. Food stores-grocery stores, meat stores, fish markets, bakeries and delicatessens.
37. Furniture stores.
38. Furrier shops including the incidental storage and conditioning of furs.
39. Hardware stores.
40. Hobby shops.
41. Household appliance stores, including radio and television sales and service.
42. Household and office cleaning services.
43. Interior decorating shops, including upholstering and making of draperies, slipcovers and other similar articles when conducted as part of the retail operation and secondary to the principal use.
44. Jewelry stores, including watch repair.
45. Laboratories—research, development and testing.
46. Leather goods and luggage stores.

47. Linen, towel, diaper and other similar supply services.
48. Locksmith shops.
49. Medical, dental and optical clinics and optical sales.
50. Musical instrument sales and repair.
51. Office supply stores.
52. Offices business and professional.
53. Optical sales.
54. Orthopedic and medical appliance and supply stores.
55. Packing and crating establishments.
56. Paint and wallpaper stores.
57. Personal computers and home electronics, sales and service.
58. Pet stores.
59. Phonograph, record and sheet music stores.
60. Photography studios or services, including the development of films and pictures.
61. Physical culture and health services, reducing salons and massage therapy.
62. Physical fitness and other similar type recreational facilities.
63. Picture framing.
64. Post offices.
65. Printing, publishing and bookbinding establishments, including photocopying, letter and newspaper press, stationery and business card and other similar job printing services.
66. Radio and television studios and stations.
67. Record, compact disc and cassette stores.
68. Recording studios.
69. Reproduction process, including printing, blueprinting, Photostatting, lithographing, engraving, stereotyping, publishing, and bookbinding.
70. Research and development activities, and testing laboratories.
71. Restaurants, bars and taverns except adult entertainment taverns.
72. Schools—music, dance, business or trade.
73. Secondhand stores and rummage shops.
74. Sewing machine sales and service, household appliances only.
75. Shoe and hat repair stores.
76. Small animal clinics not including outdoor runs and pens.
77. Small home appliances, sales and services.
78. Sporting good stores.
79. Swimming pool, hot tub and spa stores, provided there is no outside storage or display on the premises and no installation or repair services are offered.
80. Tailor shops.
81. Taxidermists.
82. Telecommunication centers and facilities.
83. Ticket agencies, amusement.
84. Toy shops.
85. Travel bureaus and transportation ticket offices.
86. Typewriter and adding machine sales and service establishments.
87. Upholstery shops.
88. Variety stores.
89. Water softener sales and service.
90. Wearing apparel shops.
91. Upholstery and interior decorating shops.

April 3, 2012

Mr. Brad Murphy
Director of Planning
Department of Planning & Development
City of Madison
215 Martin Luther King Jr. Blvd
PO Box 2985
Madison WI 53701

RE: Letter of Intent
PUD-GDP-SIP
801 South Park Street
Madison WI

Dear Mr. Murphy:

The following is submitted together with the plans, application and zoning text for staff, Plan Commission and Common Council consideration of approval.

Organizational structure:

Owner: Capital Bassett LLC
646 West Washington Ave., Train Car D
Madison WI 53703
608-516-9497
608-257-2858 fax
Contact: Pat McCaughey

Architect: TJK Design Build Inc
634 West Main Street
Madison WI 53703
608-257-1090
608-257-1092 fax
Contact: John J Bieno
jjbien@tjkdesignbuild.com

Engineer: Quam Engineering
4893 Larson Beach Road
McFarland, WI 53558
608-838-7750

Landscape Design: Richard Slayton
821 West Lakeside Street
Madison, WI 53715
608-251-6132

Introduction:

The proposed site is located on the East end of the 800 block of South Park Street. The site is approximately 16,096 sq ft in size and contains a total of 2 structures. It was formally under the control of a single developer and the deferred maintenance of the structures is extensive.

Urban Design District #7:

The building fronts along Park Street as requested in the design requirement. It is placed to accommodate the 10' requested sidewalk zone. The front façade and primary entrances face Park Street. All visible sides of the building are designed with details that compliment the front façade. Details have been provided on both façades accessible to the public that create a more pedestrian scale and character. Green building practices to help with energy efficiency are being incorporated into the design. Including but not limited to a white roof, above average insulation in both wall and roof structures, and double pane insulated low-e glass units. The building is two stories in height. Greater than 40% of the street elevation has been devoted to windows. These windows will be transparent not colored or tinted. Signage is not part of the submittal.

Deconstruction:

This proposed development envisions the deconstruction of 2 slab-on-grade structures. This would also include their associated sidewalk and paved areas. Inspections of these properties have been made by the development team. And they have concluded that the structures are beyond the capacity of any reasonable rehabilitation. Additional reports on the structures existing condition will be prepared for distribution to the staff and Plan Commission. The developer will contract to prepare a recycling and reuse plan for the buildings and the components and materials will be handled appropriately. Although the zoning code clearly encourages the preservation of existing structures the zoning codes purpose also includes promoting the general welfare of the city, encouraging the most appropriate land uses and conserving and enhancing the taxable value of lands and buildings. We believe that the Plan Commission can determine that the demolition standards are met.

Project Description:

The site under consideration for this PUD-GDP-SIP is on the near South side of Madison along a main gateway into the city. It is bordered on the West by a recently completed St Mary's hospital redevelopment, to the East are single family residences, to the North is an alley and residential development and to the South is a string of commercial buildings. The building is situated on the NW corner of the lot for several reasons. First, by placing the building at this location it allowed us the most flexibility with respect to commercial development to the South. This positioning means that we can share parking or at least create a buffer between what happens in that direction. Second it will allow us to strike a balance between maximizing the potential of the lot for building and site amenities. Finally by placing the building at this location it allowed us the greatest level of comfort with respect to the physical restraint of the site. Including but not limited to: maximizing distances from the intersection to the curb cut, alleviate potential visibility concerns for the neighborhood, create the best view corridors of the building, encourage an anchoring of the intersection of Erin Street and Park Street. Although the building itself is fairly rectilinear in nature, the gentle curve of Park Street was incorporated by designing walls that parallel it into planters and seating areas.

The building possesses a strong base, middle and cap with materials reflecting a change in the use between commercial and residential areas. Some of the materials proposed to be used on

the building are: stone and masonry, a custom metal and cedar decorative railing system, cement board and battens, stucco features in a complimentary color and a sloped roof form and canopy to anchor the Southwest corner of the building. Windows have been incorporated in a manner to accent the scale and palette of the building. The windows become smaller with greater detail as the structure increases in height.

The development group has worked to answer as many of the requests and concerns of the neighborhood as possible. We have met with them on several occasions as well as keeping communication lines open with the Alder thru out the process.

Project Schedule:

It is anticipated that construction of the SIP phase will start in the early summer of 2012 and will be completed in the fall of 2012.

Social and Economic Impact:

This development will have a positive social and economic impact. The development will substantially increase the city's tax base on an infill site with minimal if any increased cost to the city. The redevelopment will provided new work-force housing in the central city while promoting pedestrian, bicycle and mass transit circulation.

Thank you for your time in reviewing our proposal.

Sincerely,

John J Bieno, AIA
TJK Design Build Inc

DESCRIPTION

ICON'S gentle curves and sleek profile create a shape that is beyond common. Two (2) unique arm choices combined with structural element options and multiple housing sizes provide no limitations in bridging to the architectural application.

Catalog #	ICM-175-MH-208-SL-DP	Type	A
Project	Erin Square	Date	11/08/2011
Comments			
Prepared by			

SPECIFICATION FEATURES

Construction

HOUSING: Heavy wall, die-cast aluminum housing maintains a nominal .125 wall thickness for precise tolerance control and repeatability in manufacturing. **DOOR:** Heavy wall, die-cast aluminum door maintains a nominal .125 wall thickness. Continuous silicone gasketing provides an IP65 fixture rating. Toolless entry to housing is provided via two (2) recess mounted button style latches. Captive hinging is fully concealed. **UPSWEEP ARM:** Manufactured of heavy wall cast aluminum. Internal bolts guides provided for positioning arm to housing and pole. **LINEAR ARM:** Manufactured of heavy wall extruded aluminum. Arm features internal bolt guides for positioning arm to housing and pole. **STRUCTURAL MOUNT:** Die-cast aluminum cleat factory mounted and finished in luminaire color. Stainless steel structural rod measures 1/2" in diameter and is provided in luminaire finish or optional natural finish. Product functions in conjunction with linear arm. INVUE poles provided pre-

drilled for suspension mount applications. See INVUE pole brochure for complete selection of matching poles. **STRUCTURAL WALL MOUNT:** Die-cast aluminum cleat factory mounted to luminaire and finished in luminaire color. Stainless steel structural rod measures 1/2" in diameter and is provided in luminaire finish or optional natural finish. Wall bracket works in conjunction with linear arm.

Electrical

ELECTRICAL TRAY: Ballast and related electrical components are mounted to a reinforced one piece toolless release power tray. Electrical quick disconnects allow tray to be completely removed from housing providing ample hand and tool room for attachment of luminaire during installation.

Optical

LENS: Impact-resistant 1/8" thick tempered clear or optional frosted flat glass for concealment of lamp image. **OPTICAL SYSTEM:** Choice of five (5) high efficiency segmented optical systems

constructed of premium 95% reflective anodized aluminum sheet. Optical segments are rigidly mounted inside a thick gauge aluminum housing for superior protection. All segment faces are clean of rivet heads, tabs, or other means of attachment which may cause streaking in the light distribution. All reflector modules feature toolless removal, quick disconnect wiring plugs, and are toolless field rotatable in 90° increments. Medium housing (ICM) optics feature mogul-base lampholders for HID lamp sources.

Finish

Housing and arm finished in a 5 stage premium TGIC polyester powder coat paint, 2.5 mil nominal thickness for superior protection against fade and wear. Standard colors include black, bronze, grey, white, dark platinum, and graphite metallic. RAL and custom color matches available. Consult your INVUE Lighting Systems Representative for more information.

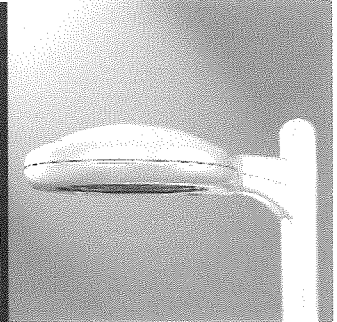

**ICM
ICON SITE
MEDIUM**

- 84 - 400W
- Pulse Start Metal Halide
- Metal Halide
- High Pressure Sodium
- Compact Fluorescent

**ARCHITECTURAL
AREA LUMINAIRE**

DIMENSIONS

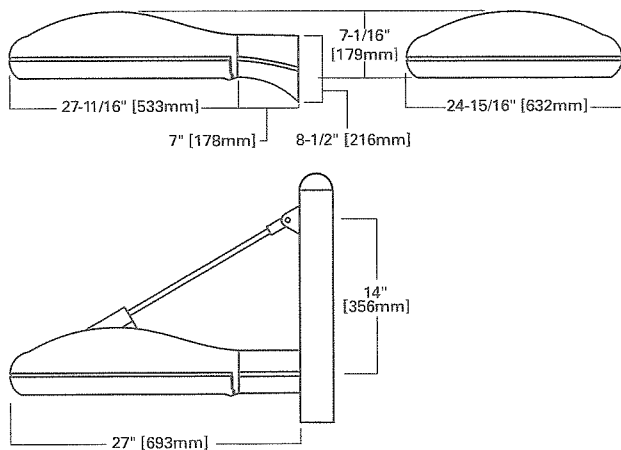

STRUCTURAL MOUNT

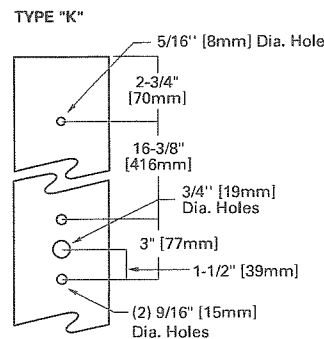

WATTAGE TABLE

Lamp Type	Wattage
Pulse Start Metal Halide (MP)®	150, 175, 250, 320, 350, 400W
High Pressure Sodium (HPS)	150, 250, 400W
Metal Halide (MH)	175, 250, 400W
Compact Fluorescent (CF)	(2) 42, (2) 57W

NOTE: ® EISA Compliant: 175-400W.

ARM DRILLING

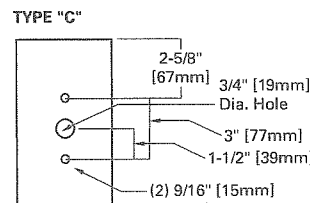

DARK SKY COMPLIANT FCO Full Cutoff

CERTIFICATION DATA
 IP65 Rated
 U.L. 1598 Listed
 3G Vibration Tested
 CSA Listed
 25°C Ambient Temperature Rating
 ISO 9001
 Full Cutoff

EPA
Effective Projected Area:
 (Sq. Ft.)
 Single: 1.09
 Single Structural: 1.11

SHIPPING DATA
 (Approximate)
 Net Weight (lbs.): 53
 Volume (cu. ft.): 4.00



MOUNTING VARIATIONS

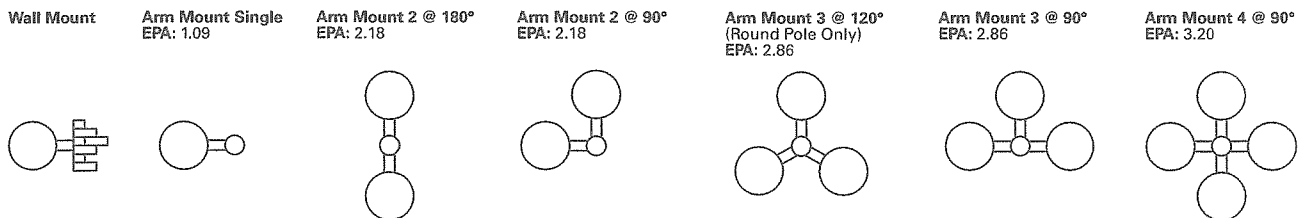

ORDERING INFORMATION

ICM-175-MH-208-SL-DP

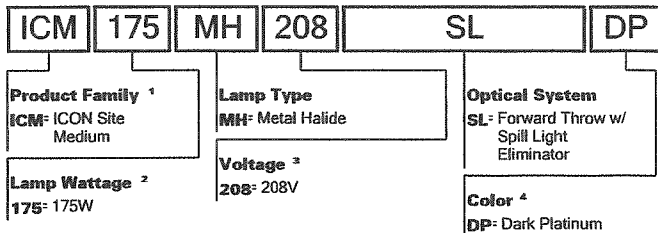

- Notes: 1 Arm not included. See accessories.
 2 Standard with mogul-base socket for HPS, MH and 175-400W MP. Standard with medium-base socket for MP lamps 150W and below.
 3 Products also available in non-US voltages and 50Hz for international markets. Consult factory for availability and ordering information.
 4 Custom and RAL color matching available upon request. Consult your INVUE Lighting Systems Representative for further information.
 5 Add as suffix in the order shown.
 6 Order separately, replace XX with color suffix.

DESCRIPTION

Entri LED features a classic and stylish design with the added benefits of solid state lighting technology, offering outstanding uniformity and energy savings. Using Cooper Lighting's proprietary LED LightBAR™ technology and AccuLED Optics Entri LED offers designers vast versatility in system design, function and performance. Use Entri LED for wall mount architectural lighting applications and egress lighting requirements. UL/cUL listed for use in wet locations.

Catalog #	ENC-COI-LED-EI-B4-D	Type	
Project	ERIN SQUARE		B
Comments		Date	11/08/11
Prepared by			

SPECIFICATION FEATURES

Construction

HOUSING: Heavy wall, one-piece, die-cast aluminum construction for precise tolerance control and repeatability in manufacturing. Integral extruded aluminum heat sink provides superior thermal heat transfer in +40°C ambient environments. Housing and heat sink are designed to offer various options for down lighting, up lighting or a combination of both up and down. **FACEPLATE / DOOR:** One-piece, die-cast aluminum construction. Captive, side hinged faceplate swings open via release of one (1) flush mount die-cast aluminum latch on housing side panel. Door closure and seal is ensured through a robust and positive retention bale latch which upon closing can be heard through distinct sound. **GASKET:** One-piece molded silicone gasket mates perfectly between the door and housing for repeatable seal. Silicone wire way plug on housing back wall seals incoming electrical leads to prevent moisture and dust entry. **LENS:** Uplight lens is impact-resistant, 5/32" thick tempered frosted glass sealed to housing with continuous bead silicone gasket. Downlight lens is LED board integrated acrylic over-optics, each individually sealed for IP66 rating. **HARDWARE:** Stainless steel mounting screws and latch hardware allow access to electrical components for installation and servicing.

Optics

DISTRIBUTION: Primary downlight distribution offers a choice of six (6) patented, high efficiency AccuLED Optics™, that maximize light collection and directional distribution onto the application region. Each optical lens is precision manufactured via injection-molding, then precisely arranged and sealed on the board media. Optional uplight LED distribution features a diffuse soft glow for enhancing architectural scenes or accentuating structural features. **LEDs:** High output LEDs, 50,000+ hours life at >70% lumen maintenance, offered standard in 4000K (+/- 275K) CCT and nominal 70 CRI.

Electrical

DRIVER: LED drivers are potted and heat sunk for optimal performance and prolonged life. Standard drivers feature electronic universal voltage (120-277V/50-60hz), greater than 0.9 power factor, less than 20% harmonic distortion and feature ambient temperature range of +40°C (104°F) down to minimum starting temperature of -30°C (-22°F). Shipped standard with Cooper Lighting proprietary circuit module designed to withstand 10kV of transient line surge. Options to control light levels, energy savings and egress capabilities (battery pack and separate circuit) are available. All LED LightBARs™ and drivers are mounted to a primary mounting plate and are easily replaced by use of quick disconnects for ease of wiring.

Mounting

JUNCTION BOX: Standard with zinc-plated, quick-mount junction box plate that mounts directly to 4" J-Box. LightBARs mount facing downward. Fixture slides over mounting plate and is secured with two (2) stainless steel fasteners. Mounting plate features a one-piece EPDM gasket on back side of plate to firmly seal fixture to wall surface, forbidding entry of moisture and particulates. Optional mounting arrangements utilize a die-cast mounting adaptor box to allow for LED battery pack, surface conduit and through branch wiring. Entri LED is approved for mounting on combustible surfaces.

Finish

Housing is finished in 5-stage Super TGIC polyester powder coat paint, 2.5 mil nominal thickness for superior protection against fade and wear. LightBAR™ cover plates are standard white and may be specified to match finish of luminaire housing. Standard colors include black, bronze, grey, white, dark platinum and graphite metallic. RAL and custom color matches available. Consult Outdoor Architectural Colors brochure for a complete selection.

Warranty

Entri LED features a five-year limited warranty.

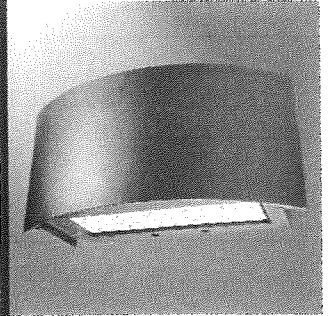

**ENC
ENTRI LED
ROUND CLEAN**

1 - 2 LightBARs
Solid State LED

ARCHITECTURAL WALL
LUMINAIRE

Sustainable LED Design

CERTIFICATION DATA

UL/cUL Listed
ISO 9001
IP66 LightBARs
ARRA Compliant
LM79 / LM80 Compliant

ENERGY DATA

Electronic LED Driver
>0.9 Power Factor
<20% Total Harmonic Distortion
120-277V/50 & 60hz, 347V/60hz,
480V/60hz
-30°C Minimum Temperature
40°C Ambient Temperature Rating

SHIPPING DATA

Approximate Net Weight:
16 lbs. (7.3 kgs.)



DIMENSIONS

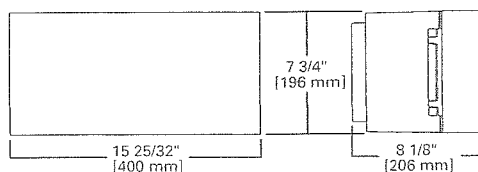

CONDUIT MOUNT / BATTERY BACK BOX

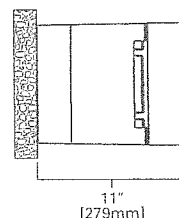

POWER AND LUMENS BY BAR COUNT

LUMEN MULTIPLIER

Number of LightBARs	DISTRIBUTION							
	Power [Watts]	Current @ 120V [A]	Current @ 277V [A]	BL2	BL3	BL4	GZW	SLR/ SLL
7 LED LIGHTBAR								
C01	27	0.23	0.13	1,704	1,615	1,686	1,688	1,550
C02	54	0.46	0.21	3,408	3,230	3,372	3,375	3,099
21 LED LIGHTBAR								
B01	27	0.23	0.13	1,770	1,625	1,720	1,725	1,571
B02	51	0.43	0.20	3,540	3,249	3,440	3,450	3,142

Ambient Temperature	Lumen Multiplier
10°C	1.04
15°C	1.03
25°C	1.00
40°C	0.96

ORDERING INFORMATION

SAMPLE NUMBER: ENC-B02-LED-E1-BL3-GM

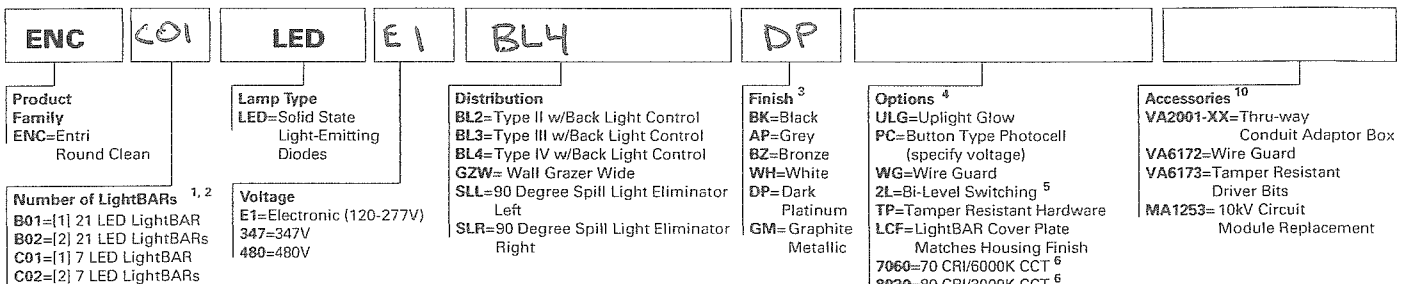

NOTES:

- Standard 4000 K CCT and nominal 70 CRI. LightBARs for downlight use only.
- 21 LED LightBAR powered at 350mA, 7 LED LightBAR powered at 1A.
- Custom and RAL color matching available upon request. Consult your customer service representative for further information.
- Add as suffix in the order shown.
- Low-level output varies by bar count, consult factory. Not available with 347V or 480V. Available with 2 Bars (B02 or C02) only.
- Consult customer service for lead times and lumen multiplier.
- Available with B02 or C02, only (1) LightBAR on street side will be wired to sensor. Time Delay factory setting 15 minutes. When ordered with Option PC, both light bars will be connected to photocell as primary switching means. Standard sensor lens covers 8-foot mount height, 360-degree coverage, maximum 48-foot diameter. Not available in all configurations or with BBB or CWB options.
- Specify 120 or 277V. LED standard integral battery pack is rated for minimum operating temperature 32°F (0°C). Operates (1) lightbar for 90 minutes. Not available in all configurations or with OSB option. Consult factory.
- Specify 120 or 277V. LED cold weather integral battery pack is rated for minimum operating temperature -4°F (-20°C). Operates (1) lightbar for 90 minutes. Not available in all configurations or with OSB option.
- Order separately, replace XX with color suffix.

DESCRIPTION

Entri LED features a classic and stylish design with the added benefits of solid state lighting technology, offering outstanding uniformity and energy savings. Using Cooper Lighting's proprietary LED LightBAR™ technology and AccuLED Optics Entri LED offers designers vast versatility in system design, function and performance. Use Entri LED for wall mount architectural lighting applications and egress lighting requirements. UL/cUL listed for use in wet locations.

Catalog #	ENC-101-LED-EI-62W-DP	Type	
Project	ERIN SQUARE		C
Comments		Date	
Prepared by			11/08/11

SPECIFICATION FEATURES

Construction

HOUSING: Heavy wall, one-piece, die-cast aluminum construction for precise tolerance control and repeatability in manufacturing. Integral extruded aluminum heat sink provides superior thermal heat transfer in +40°C ambient environments. Housing and heat sink are designed to offer various options for down lighting, up lighting or a combination of both up and down. **FACEPLATE / DOOR:** One-piece, die-cast aluminum construction. Captive, side hinged faceplate swings open via release of one (1) flush mount die-cast aluminum latch on housing side panel. Door closure and seal is ensured through a robust and positive retention bale latch which upon closing can be heard through distinct sound. **GASKET:** One-piece molded silicone gasket mates perfectly between the door and housing for repeatable seal. Silicone wire way plug on housing back wall seals incoming electrical leads to prevent moisture and dust entry. **LENS:** Uplight lens is impact resistant, 5/32" thick tempered frosted glass sealed to housing with continuous bead silicone gasket. Downlight lens is LED board integrated acrylic over-optics, each individually sealed for IP66 rating. **HARDWARE:** Stainless steel mounting screws and latch hardware allow access to electrical components for installation and servicing.

Optics

DISTRIBUTION: Primary downlight distribution offers a choice of six (6) patented, high efficiency AccuLED Optics™, that maximize light collection and directional distribution onto the application region. Each optical lens is precision manufactured via injection-molding, then precisely arranged and sealed on the board media. Optional uplight LED distribution features a diffuse soft glow for enhancing architectural scenes or accentuating structural features. **LEDs:** High output LEDs, 50,000+ hours life at >70% lumen maintenance, offered standard in 4000K (+/- 275K) CCT and nominal 70 CRI.

Electrical

DRIVER: LED drivers are potted and heat sunk for optimal performance and prolonged life. Standard drivers feature electronic universal voltage (120-277V/50-60hz), greater than 0.9 power factor, less than 20% harmonic distortion and feature ambient temperature range of +40°C (104°F) down to minimum starting temperature of -30°C (-22°F). Shipped standard with Cooper Lighting proprietary circuit module designed to withstand 10kV of transient line surge. Options to control light levels, energy savings and egress capabilities (battery pack and separate circuit) are available. All LED LightBARs™ and drivers are mounted to a primary mounting plate and are easily replaced by use of quick disconnects for ease of wiring.

Mounting

JUNCTION BOX: Standard with zinc-plated, quick-mount junction box plate that mounts directly to 4" J-Box. LightBARs mount facing downward. Fixture slides over mounting plate and is secured with two (2) stainless steel fasteners. Mounting plate features a one-piece EPDM gasket on back side of plate to firmly seal fixture to wall surface, forbidding entry of moisture and particulates. Optional mounting arrangements utilize a die-cast mounting adaptor box to allow for LED battery pack, surface conduit and through branch wiring. Entri LED is approved for mounting on combustible surfaces.

Finish

Housing is finished in 5-stage Super TGIC polyester powder coat paint, 2.5 mil nominal thickness for superior protection against fade and wear. LightBAR™ cover plates are standard white and may be specified to match finish of luminaire housing. Standard colors include black, bronze, grey, white, dark platinum and graphite metallic. RAL and custom color matches available. Consult Outdoor Architectural Colors brochure for a complete selection.

Warranty

Entri LED features a five-year limited warranty.

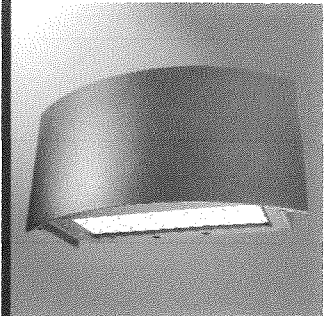

**ENC
ENTRI LED
ROUND CLEAN**

1 - 2 LightBARs
Solid State LED

ARCHITECTURAL WALL
LUMINAIRE

LED

CERTIFICATION DATA

UL/cUL Listed
ISO 9001
IP66 LightBARs
ARRA Compliant
LM79 / LM80 Compliant

ENERGY DATA

Electronic LED Driver
>0.9 Power Factor
<20% Total Harmonic Distortion
120-277V/50 & 60hz, 347V/60hz, 480V/60hz
-30°C Minimum Temperature
40°C Ambient Temperature Rating

SHIPPING DATA

Approximate Net Weight:
16 lbs. (7.3 kgs.)

DIMENSIONS

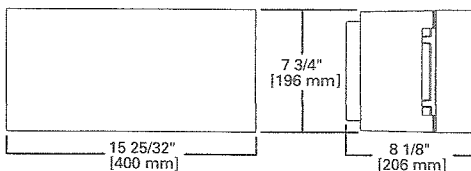

CONDUIT MOUNT / BATTERY BACK BOX

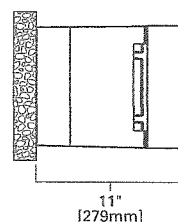

POWER AND LUMENS BY BAR COUNT

Number of LightBARs	DISTRIBUTION							
	Power [Watts]	Current @ 120V [A]	Current @ 277V [A]	BL2	BL3	BL4	GZW	SLR/ SLL
7 LED LIGHTBAR								
C01	27	0.23	0.13	1,704	1,615	1,686	1,588	1,550
C02	54	0.46	0.21	3,408	3,230	3,372	3,375	3,099
21 LED LIGHTBAR								
B01	27	0.23	0.13	1,770	1,625	1,720	1,725	1,571
B02	51	0.43	0.20	3,540	3,249	3,440	3,450	3,142

LUMEN MULTIPLIER

Ambient Temperature	Lumen Multiplier
10°C	1.04
15°C	1.03
25°C	1.00
40°C	0.96

ORDERING INFORMATION

SAMPLE NUMBER: ENC-B02-LED-E1-BL3-GM

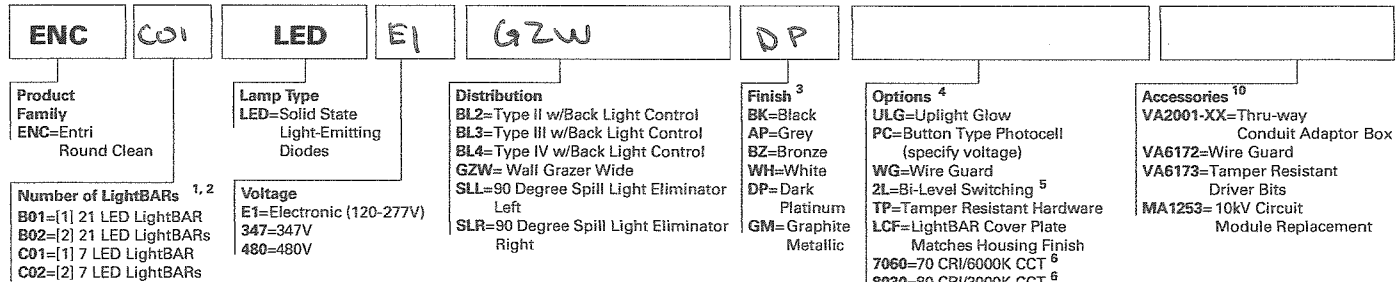

NOTES:

- Standard 4000 K CCT and nominal 70 CRI LightBARs for downlight use only.
- 21 LED LightBAR powered at 350mA, 7 LED LightBAR powered at 1A.
- Custom and RAL color matching available upon request. Consult your customer service representative for further information.
- Add as suffix in the order shown.
- Low-level output varies by bar count, consult factory. Not available with 347V or 480V. Available with 2 Bars (B02 or C02) only.
- Consult customer service for lead times and lumen multiplier.
- Available with B02 or C02, only (1) LightBAR on street side will be wired to sensor. Time Delay factory setting 15 minutes. When ordered with Option PC, both light bars will be connected to photocell as primary switching means. Standard sensor lens covers 8-foot mount height, 360-degree coverage, maximum 48-foot diameter. Not available in all configurations or with BBB or CWB options.
- Specify 120 or 277V. LED standard integral battery pack is rated for minimum operating temperature 32°F (0°C). Operates (1) lightbar for 90 minutes. Not available in all configurations or with OSB option. Consult factory.
- Specify 120 or 277V. LED cold weather integral battery pack is rated for minimum operating temperature -4°F (-20°C). Operates (1) lightbar for 90 minutes. Not available in all configurations or with OSB option.
- Order separately, replace XX with color suffix.

PROPOSED FACILITY FOR:

ERIN SQUARE

801 SOUTH PARK STREET
MADISON, WISCONSIN

TJK TJK Design Build
634 West Main Street
Madison, WI 53703
DESIGNBUILD 608-257-1090 FAX 608-257-1092

INDEX OF DRAWINGS:

- C-1.0 EXISTING SITE PLAN
- C-1.1 PROPOSED SITE PLAN
- C-1.2 GRADING AND EROSION CONTROL PLAN
- C-1.5 LANDSCAPE PLAN
- C-1.6 PHOTOMETRIC PLAN
- A-1.1 FIRST FLOOR PLAN
- A-1.2 SECOND FLOOR PLAN
- A-2.1 EXTERIOR ELEVATIONS

TO OBTAIN LOCATIONS OF PARTICIPANTS UNDERGROUND FACILITIES BEFORE YOU DIG IN WISCONSIN

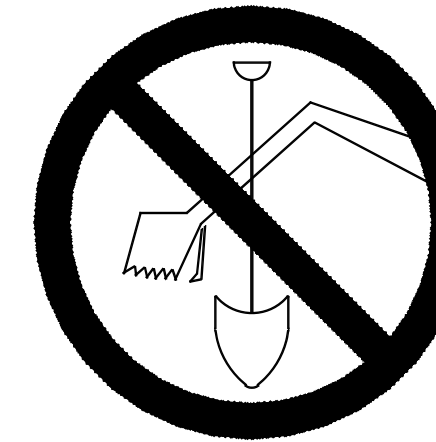

CALL DIGGERS HOTLINE
1-800-242-8511
TOLL FREE

WIS STATUTE 182.0175(1974)
REQUIRES MIN. 3 WORK DAYS
NOTICE BEFORE YOU EXCAVATE

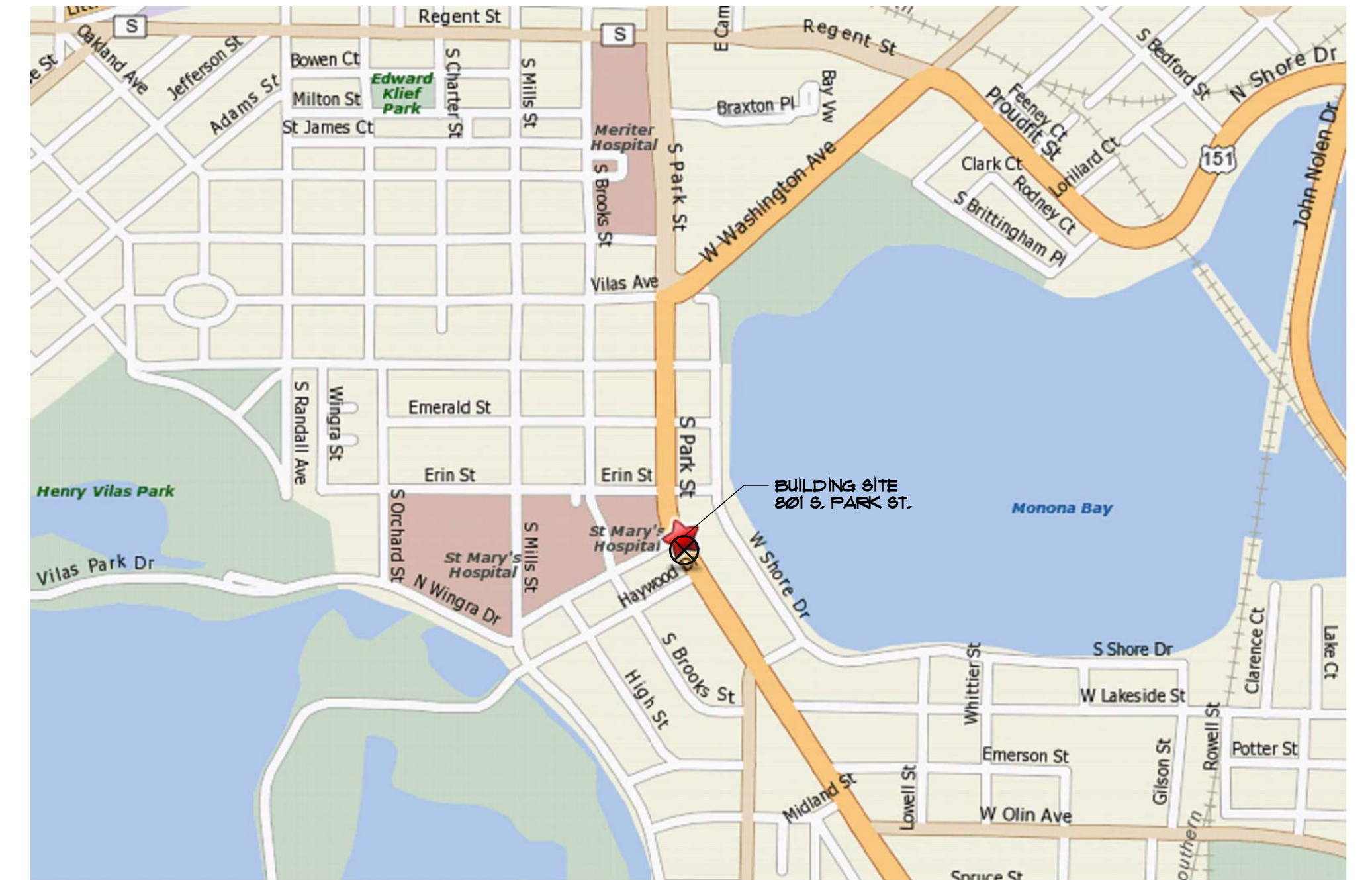

SITE LOCATION MAP

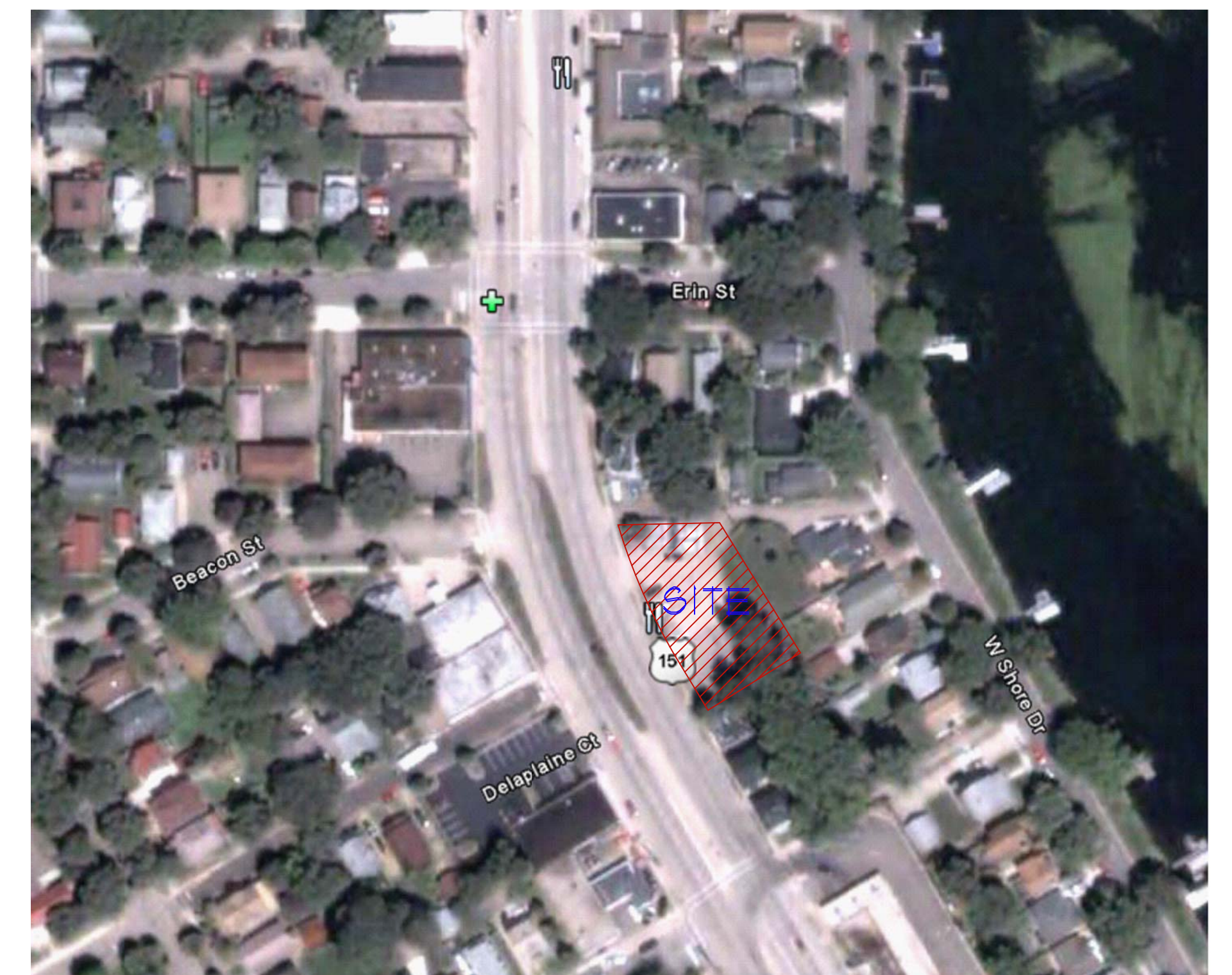

AERIAL VIEW

PROPOSED FACILITY FOR:
801 SOUTH PARK STREET

PHOTOS OF EXISTING SITE CONDITIONS:

MADISON, WI

PHOTOS:



EXISTING
BUILDING



SITE VIEW FROM NORTHEAST



EAST PROPERTY LINE
LOOKING SOUTH



SITE VIEW FROM SOUTHWEST



NORTHWEST OF SITE
LOOKING WEST



SITE VIEW FROM NORTHWEST



SITE VIEW FROM NORTHWEST



SITE VIEW FROM NORTHWEST



PARK STREET



SITE VIEW FROM SOUTHWEST



SITE VIEW FROM WEST



WEST OF SITE
LOOKING NORTHEAST

PHOTOS OF EXISTING SITE CONDITIONS:

MADISON, WI

PHOTOS:



SOUTH CORNER OF LOT
LOOKING NORTH



SOUTH CORNER OF LOT
LOOKING NORTHWEST



WEST CORNER OF LOT
LOOKING NORTHWEST



NORTHEAST CORNER OF LOT
LOOKING SOUTHWEST



SOUTH CORNER OF SITE
LOOKING SOUTH



SITE VIEW FROM NORTHWEST



SITE VIEW FROM WEST



SITE VIEW FROM SOUTHWEST



EAST END OF ALLEY
LOOKING WEST



CENTER OF ALLEY
LOOKING NORTHWEST



CENTER OF ALLEY
LOOKING NORTHEAST



WEST END OF ALLEY
LOOKING EAST

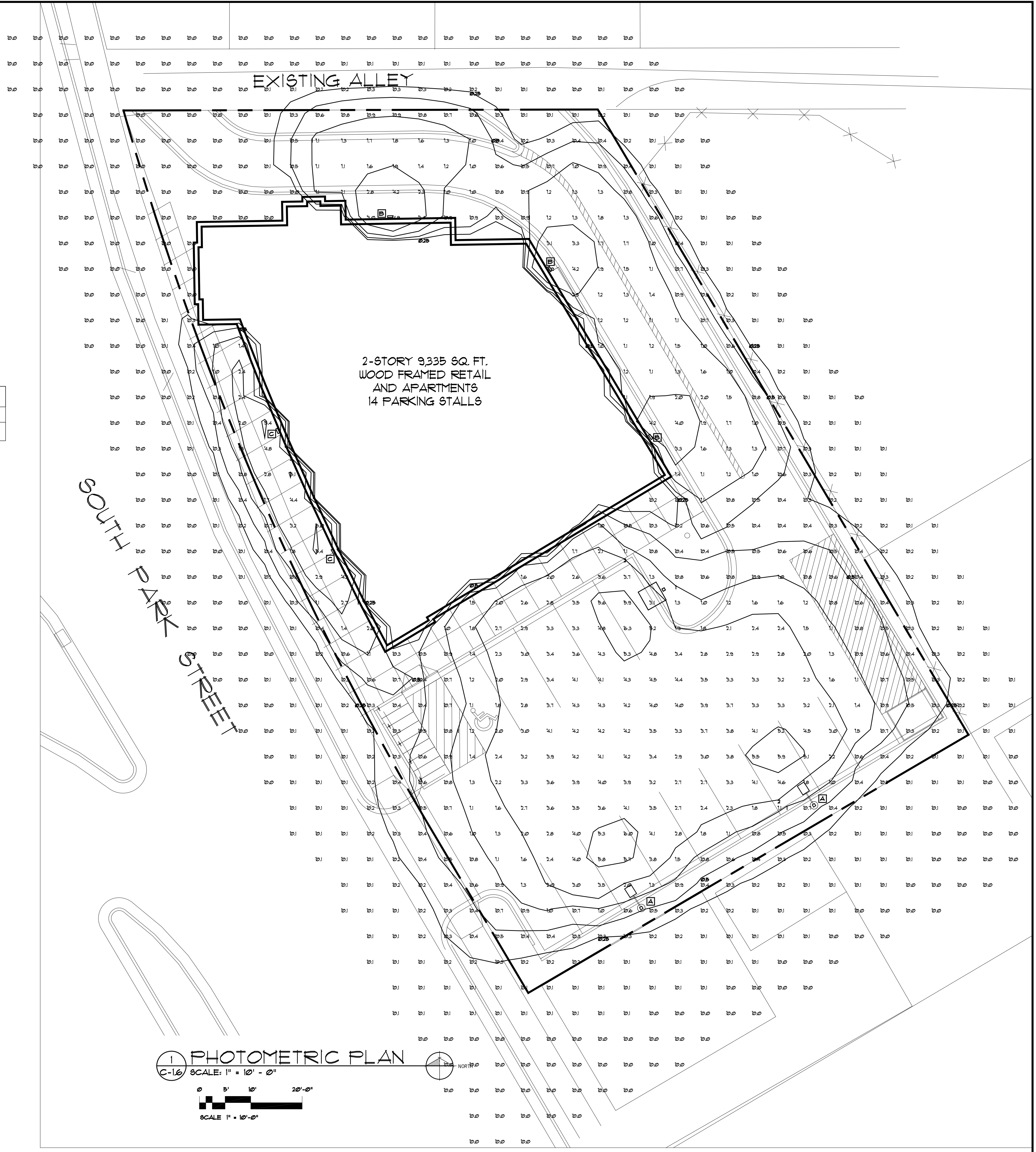

STATISTICS						
Description	Symbol	Avg	Max	Min	Max/Min	Avg/Min
Calc Zone %	+	0.7 fc	6.3 fc	0.0 fc	N / A	N / A

LIGHT FIXTURE KEY

- A** COOPER LIGHTING, INVUE 400W MH SINGLE HEAD PARKING LOT LIGHT FIXTURES MODEL * IC11-TB-MH-200-9L-DP 12'-0" X 4" 60 STEEL POLE ON 3'-0" CONC. BASE (15'-0" FROM GRADE)
- B** COOPER LIGHTING, INVUE ENTRI LED WAL-PAC LIGHT FIXTURE CATALOG * ENC-C01-LED-EI-BL4-DP (9'-0" FROM GRADE)
- C** COOPER LIGHTING, INVUE ENTRI LED WAL-PAC LIGHT FIXTURE CATALOG * ENC-C01-LED-EI-G211-DP (8'-0" FROM GRADE)

PHOTOMETRIC PLAN
C-16 SCALE: 1" = 10'-0"

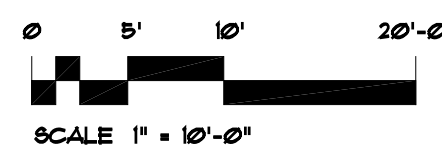

LANDSCAPE WORKSHEET

I. Number of Trees Required

The number of trees required for a parking lot is based on the number of parking stalls. Using the Schedule for Required Trees on the reverse side of this worksheet, determine the number of trees required. (Example: One tree is required for 10 parking stalls).

Landscape requirements for storage areas are determined by dividing the total square footage of the storage area by (300) square feet. This converts area to stalls. (Example: 10,000 square feet is equivalent to (33) stalls or (3) trees and (160) points).

Number of Parking Stalls **14**

Total Square Footage of the Storage Area
Divided by Three Hundred (300) Square Feet **1**

Number of Canopy Shade Trees Required (2" - 2 1/2" Caliper)
(See Schedule on reverse side) **3**

TOTAL

II. Number of Landscape Points Required

The number of points required is also based on the number of parking stalls. Using the Point Schedule for Landscape Elements on the reverse side of this worksheet, determine the number of points required. (Example: 49.5 points are required for 10 stalls). A point fraction of (.5) or less may be disregarded, while a fraction in excess of (.5) must be counted as one point. Thus: 49.5 points would be rounded down to 49.0 points required.

The number of points required for loading areas is (75) points for each loading berth.
(See Schedule on reverse side) **75**

Number of Points Required (See Schedule on reverse side) **144**

TOTAL

Tabulation of Points and Credits

Indicate below the quantity and points for all pertinent landscape elements. Also, credit information for boundary screening and any existing elements to be retained.

ELEMENT	POINT VALUE	QUANTITY	POINTS ACHIEVED	CREDITS	
				QUANTITY	POINTS
Canopy Tree: 2" - 2 1/2"	35			2	70
Deciduous Shrub	2				
Evergreen Shrub	3				
Decorative Wall or Fence (per 10 L.F.)	5				
Earth Berm (per 10 L.F.) Avg. Height 30" Avg. Height 15"	5 2				
Evergreen Trees 3' height minimum	15	18	270		
Canopy Tree or Small Tree 1 1/2" - 2" Caliper (i.e., Crab, Hawthorn)	15	3	45		
		Sub Totals	315	+	70
				TOTAL	385

Total No. of Points Provided
(Equal to or greater than points required)

*Trees required in Part I above, are not to be included in the point count.

PLANT SCHEDULE AND LEGEND

Key	Botanical Name	Common Name	Qty	Planting Size	Root Spec	Spacing	Comments
Major Deciduous Trees							
AR	Acer rubrum 'Red Sunset'	Red Sunset Maple	1	2-2 1/2" cal	B&B	As shown	Straight leader
CJ	Cercidiphyllum japonicum	Katsuratree	1	2-2 1/2" cal	B&B	As shown	Straight leader
QR	Quercus robur x bicolor 'Long'	Regal Prince Oak	3	2-2 1/2" cal	B&B	As shown	Straight leader
TCJ	Tilia cordata 'June Bride'	June Bride Littleleaf Linden	2	2-2 1/2" cal	B&B	As shown	Straight leader, matched
Minor Deciduous Trees							
AG	Amelanchier grand. 'Princess Diana'	Princess Diana Serviceberry	3	6' HT min	B&B	As shown	Multi-stem, matched full plants
Evergreens							
JCS	Juniperus chinensis 'Sea Green'	Sea Green Juniper	10	30" HT min	B&B	As shown	Full plants, matched
TMH	Taxus x media 'Hicksii'	Hicks Yew	9	3' HT min	B&B	As shown	Full plants
TEG	Thuja occidentalis 'Emerald Green'	Emerald Green Arborvitae	15	3' HT min	B&B	As shown	Full plants, matched
Deciduous Shrubs							
DG	Deutzia gracilis 'Chardonny Pearls'	Chardonny Pearls Deutzia	6	18" HT min	CONT	As shown	Full, matched plants
IV	Itea virginica 'Little Henry'	Little Henry Sweetpire	7	18" HT min	CONT	As shown	Full, matched plants
RR	Rosa rugosa 'Foxi'	Foxi Pavement Rose	2	18" HT min	CONT	As shown	Full, matched plants
Perennials, Grasses and Groundcovers							
cakf	Calamagrostis acutifolia 'Karl Foerster'	Karl Foerster Grass	20	1 GAL	CONT	24" o.c.	Full, matched plants
pap	Pennisetum alope. 'PennStripe'	Var Compact Fountain Grass	44	1 GAL	CONT	24" o.c.	Full, matched plants
ssi	Sedum spectabile 'Iceberg'	Iceberg Sedum	20	1 GAL	CONT	24" o.c.	Full, matched plants

SM Stone Mulch BM Shredded Bark Mulch

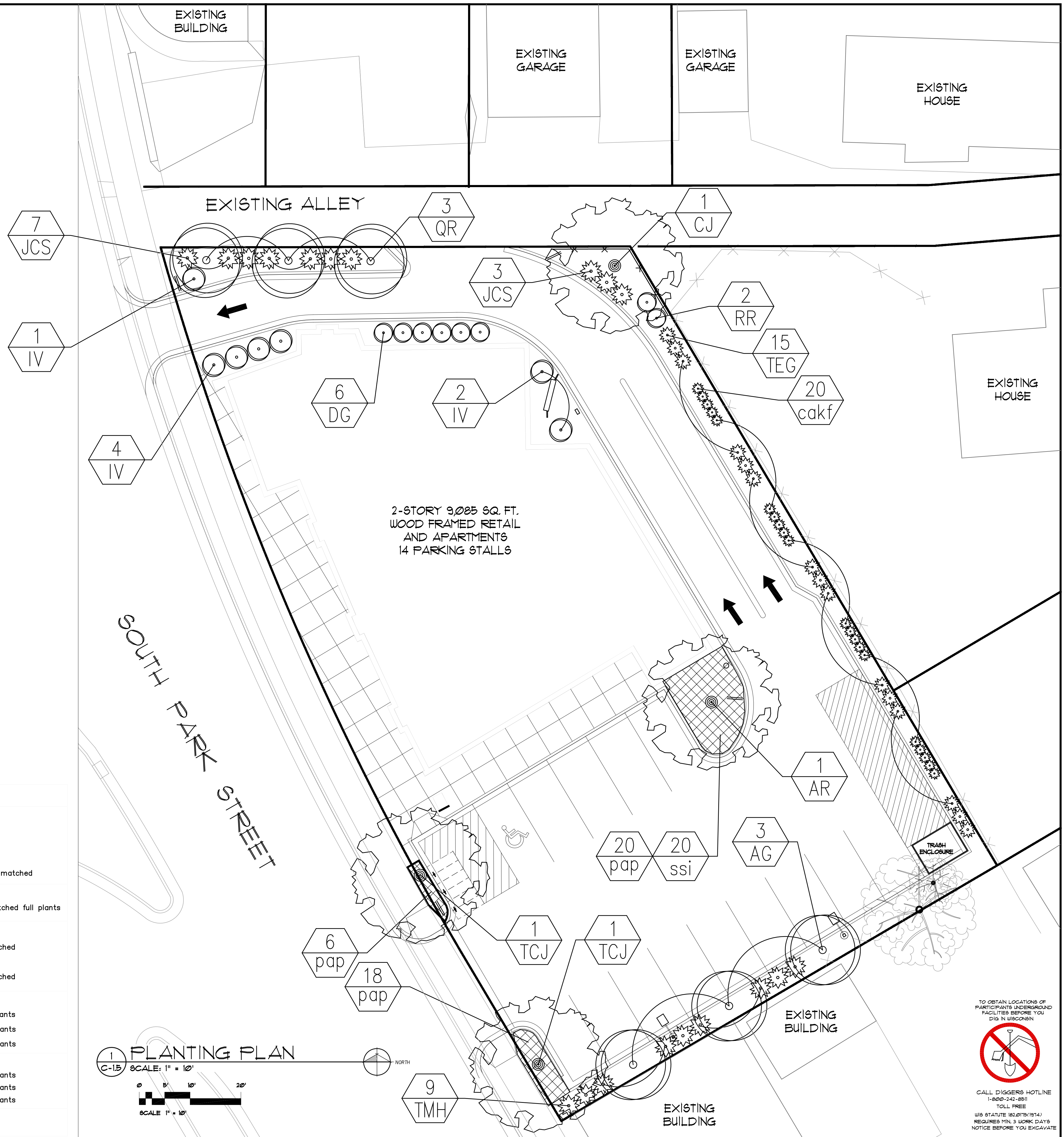

1 PLANTING PLAN

C-15 SCALE: 1" = 10'

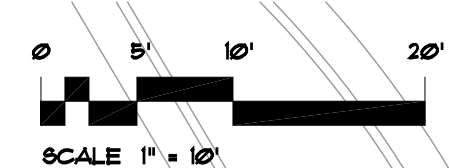

SCALE 1" = 10'

TO OBTAIN LOCATIONS OF PARTICIPANTS UNDERGROUND FACILITIES BEFORE YOU DIG IN WISCONSIN

CALL DIGGERS HOTLINE 1-800-242-6911 TOLL FREE
WIS STATUTE (82.015)(14) REQUIRED MIN. 3 WORK DAYS NOTICE BEFORE YOU EXCAVATE

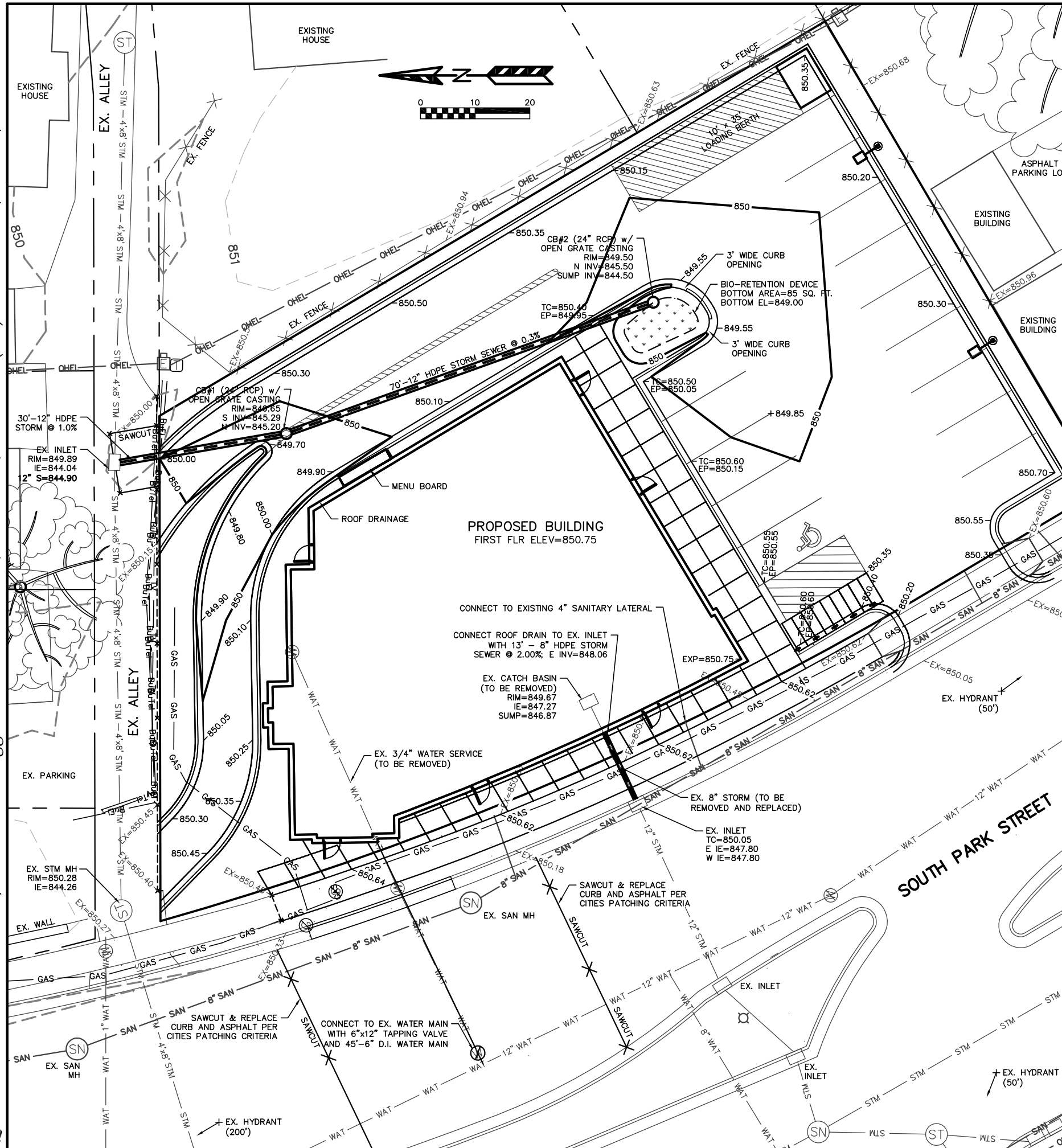

UTILITY NOTES:

ALL WORK IN THE PUBLIC RIGHT-OF-WAY SHALL BE PERFORMED BY A PRE-APPROVED CONTRACTOR AUTHORIZED TO WORK IN THE RIGHT-OF-WAY.

THE CONTRACTOR SHALL REPLACE ALL DAMAGED SIDEWALK AND CURB AS DIRECTED BY THE CITY CONSTRUCTION ENGINEER.

THE CONTRACTOR SHALL OBTAIN A STREET EXCAVATION PERMIT FOR THE INSTALLATION OF UTILITIES REQUIRED TO SERVE THIS PROJECT. THE CONTRACTOR SHALL PAY THE PERMIT FEE, INSPECTION FEE, AND STREET DEGRADATION FEE AND SHALL COMPLY WITH ALL CONDITIONS OF THE PERMIT.

THE CONTRACTOR SHALL OBTAIN A PERMIT TO PLUG EACH EXISTING SANITARY SEWER LATERAL THAT SERVES A BUILDING THAT IS PROPOSED FOR DEMOLITION. FOR EACH LATERAL TO BE PLUGGED THE OWNER SHALL DEPOSIT \$1,000 WITH THE CITY ENGINEER IN TWO SEPARATE CHECKS IN THE FOLLOWING AMOUNTS: (1) \$100 NON-REFUNDABLE DEPOSIT FOR THE COST OF INSPECTION OF THE PLUGGING BY CITY STAFF; AND (2) \$900 FOR THE COST OF CITY CREWS TO PERFORM THE PLUGGING. IF THE OWNER ELECTS TO COMPLETE THE PLUGGING OF A LATERAL BY PRIVATE CONTRACTOR AND THE PLUGGING IS INSPECTED AND APPROVED BY THE CITY ENGINEER, THE \$900 FEE SHALL BE REFUNDED TO THE OWNER.

ALL SANITARY SEWER AND WATER MAIN CONSTRUCTION SHALL BE IN COMPLIANCE WITH THE CITY OF MADISON AND WISCONSIN DEPARTMENT OF COMMERCE STANDARDS.

ALL WATER MAIN SHALL BE BURIED TO A DEPTH OF 6.5 FEET. THE DEPTH IS DEFINED AS THE DISTANCE BETWEEN THE FINISHED GRADE ELEVATION AND THE TOP OF WATER MAIN OR SERVICE.

ANY UTILITIES WHICH ARE DAMAGED BY THE CONTRACTOR SHALL BE REPAIRED TO THE OWNER'S SATISFACTION AT THE CONTRACTOR'S EXPENSE.

ALL UNDERGROUND EXTERIOR NON-METALLIC SEWERS/MAINS AND WATER SERVICES/MAINS MUST BE PROVIDED WITH TRACER WIRE OR OTHER METHODS IN ORDER TO BE LOCATED IN ACCORDANCE WITH 182.0715(2r) OF STATE STATUTES.

THE PROPOSED ELECTRIC, TELEPHONE AND GAS UTILITY LOCATIONS ARE NOT SHOWN. ACTUAL LOCATIONS AND DESIGN SHALL BE COMPLETED BY OTHERS.

ANY DAMAGE TO PARK STREET AND ALLEY PAVEMENTS WILL REQUIRE PATCHING IN ACCORDANCE WITH THE CITY ENGINEERING STREET PATCHING CRITERIA.

THE CONTRACTOR SHALL VERIFY ALL EXISTING UTILITY LOCATIONS, SIZES, MATERIALS, AND ELEVATIONS PRIOR TO CONSTRUCTION.

EROSION NOTES:

THE EXISTING PARKING AREA AGGREGATE WILL SERVE AS THE STONE TACKING PAD DURING CONSTRUCTION. THE TRACKING PAD IS TO BE MAINTAINED BY THE CONTRACTOR IN A CONDITION WHICH WILL PREVENT THE TRACK OF MUD OR DRY SEDIMENT ONTO THE ADJACENT PUBLIC STREETS. SEDIMENT REACHING THE PUBLIC ROAD SHALL BE REMOVED BY STREET CLEANING (NOT HYDRAULIC FLUSHING) BEFORE THE END OF EACH WORKDAY.

EROSION CONTROL DEVICES SHALL BE INSTALLED PRIOR TO GRADING OPERATIONS AND SHALL BE PROPERLY MAINTAINED FOR MAXIMUM EFFECTIVENESS UNTIL VEGETATION IS ESTABLISHED. ALL EROSION CONTROL MEASURES AND STRUCTURES SERVING THE SITE MUST BE INSPECTED AT LEAST WEEKLY OR WITHIN 24 HOURS OF A 0.5 INCH RAIN EVENT. ALL MAINTENANCE WILL FOLLOW AN INSPECTION WITHIN 24 HOURS.

EROSION CONTROL IS THE RESPONSIBILITY OF THE CONTRACTOR UNTIL ACCEPTANCE OF THIS PROJECT. EROSION CONTROL MEASURES AS SHOWN SHALL BE THE MINIMUM PRECAUTIONS THAT WILL BE ALLOWED. THE CONTRACTOR SHALL BE RESPONSIBLE FOR RECOGNIZING AND CORRECTING ALL EROSION CONTROL PROBLEMS THAT ARE A RESULT OF CONSTRUCTION ACTIVITIES. ADDITIONAL EROSION CONTROL MEASURES, AS REQUESTED IN WRITING BY THE STATE OR LOCAL INSPECTORS, OR THE DEVELOPER'S ENGINEER, SHALL BE INSTALLED WITHIN 24 HOURS.

WATERING PROVISION: FOR THE FIRST SIX WEEKS AFTER THE INITIAL STABILIZATION (E.G., SEED & MULCH, EROSION MAT, SOD) OF A DISTURBED AREA, PROVISIONS SHALL BE MADE FOR WATERING WHENEVER MORE THAN 7 DAYS OF DRY WEATHER ELAPSE.

SOIL STOCKPILES: A ROW OF SILT FENCE PLACED DOWNSLOPE AND AT LEAST 10 FEET AWAY FROM THE STOCKPILE SHALL PROTECT ALL STOCKPILES. SOIL STOCKPILES THAT ARE INACTIVE FOR MORE THAN 14 CONSECUTIVE DAYS SHALL BE STABILIZED WITH SEED & MULCH, EROSION MAT, POLYMER, OR COVERED WITH TERPS OR SIMILAR MATERIAL. NO STOCKPILE SHALL BE PLACED WITHIN 20 FEET OF A DRAINAGE WAY.

SILT FENCE AND STOCKPILES SHALL BE FIELD LOCATED BY THE ENGINEER.

ADDITIONAL EROSION CONTROL MEASURES WILL BE INSTALLED AS NEEDED.

TIME SCHEDULE:

NOVEMBER 21, 2011 INSTALL EROSION CONTROL DEVICES.
 NOVEMBER 21 - DECEMBER 11, 2011 REMOVE EXISTING BUILDING, FOUNDATION, AND ASPHALT PARKING LOT.
 DEC. 11, 2011 - AUGUST 15, 2012 CONSTRUCT BUILDING, UTILITIES, SIDEWALK, PARKING LOT, AND RESTORE DISTURBED AREAS.

RESTORATION NOTES:

ALL PEROUS DISTURBED AREAS SHALL RECEIVE A MINIMUM OF FOUR (4) INCHES OF TOPSOIL, SEED AND MULCH. ALL PEROUS DISTURBED AREAS SHALL RECEIVE FERTILIZER EXCEPT NATIVE PLANTING AREAS. RESTORATION WILL OCCUR AS SOON AFTER THE DISTURBANCE AS PRACTICAL. NET DETENTION NATIVE SEED MIXTURES SHALL BE USED FOR THE BOTTOM OF THE DETENTION POND. SEED MIXTURE 40 SHALL BE USED ON ALL OTHER DISTURBED AREAS. MIXTURES SHALL BE IN ACCORDANCE WITH SECTION 630 OF D.O.T. SPECIFICATIONS. AN EQUAL AMOUNT OF ANNUAL RYEGRASS SHALL BE ADDED TO THE MIX.

SEED MIXTURES SHALL BE APPLIED AT THE RATE OF FOUR (4) POUNDS PER 1,000 SQUARE FEET.
 FERTILIZER SHALL BE APPLIED AT THE RATE OF FOUR (4) POUNDS PER 1,000 SQUARE FEET. MULCH SHALL CONSIST OF HAY OR STRAW APPLIED AT THE RATE OF 2 TONS PER ACRE. FERTILIZER SHALL MEET THE MINIMUM REQUIREMENTS THAT FOLLOW: NITROGEN, NOT LESS THAN 16%; PHOSPHORIC ACID, NOT LESS THAN 8% POTASH, NOT LESS THAN 8%.

OWNER:

??????????

ENGINEER:

QUAM ENGINEERING, LLC
 ATTN: RYAN QUAM
 4604 SIGGELKOW ROAD, SUITE A
 MCFARLAND, WI 53558

LEGEND:

- 851 --- EXISTING MINOR CONTOUR.
- 850 --- EXISTING MAJOR CONTOUR.
- 851 --- PROPOSED MAJOR CONTOUR.
- 850 --- PROPOSED MAJOR CONTOUR.
- 850.00 --- PROPOSED SPOT ELEVATION
- TW=850.00 - PROPOSED TOP OF WALL ELEVATION
- FF=850.60 - FIRST FLOOR ELEVATION.
- EXP=850.00 - BUILDING EXPOSURE ELEVATION.

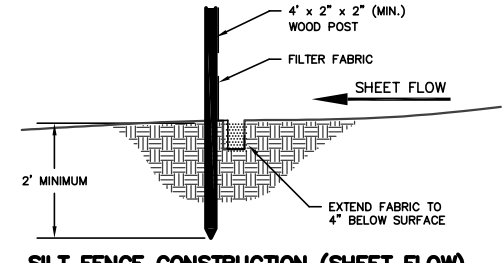

BIORETENTION DETAIL

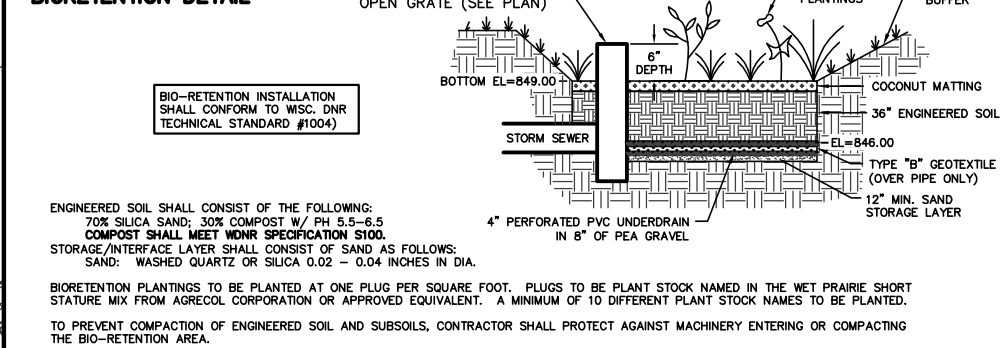

634 West Main Street
 Madison, WI 53703
 608-257-1090
 FAX 608-257-1092

QUAM ENGINEERING, LLC
 Residential and Commercial Site Design Consultants

4604 Siggekkow Road, Suite A; McFarland, Wisconsin 53558
 Phone (608) 838-7750; Fax (608) 838-7752

COPYRIGHTED DRAWING
 THIS DOCUMENT OR THE INFORMATION HEREIN IS NOT TO BE REPRODUCED, DISTRIBUTED, USED OR DISCLOSED EITHER IN WHOLE OR PART UNLESS AUTHORIZED BY TJK DESIGN BUILD

PROPOSED FACILITY FOR:
801 SOUTH PARK STREET
 MADISON, WISCONSIN
SHEET: GRADING, EROSION CONTROL, AND UTILITY PLAN

C-1.2
 10.31.11

PARKING LOT PLAN SITE INFORMATION BLOCK

SITE ADDRESS MADISON, WISCONSIN
 SITE ACREAGE (TOTAL) 15,254 SQ FT ± 0.36 ACRES
 NUMBER OF BUILDING STORIES (ABOVE GRADE) 2
 BUILDING HEIGHT 28'-0"
 TYPE OF CONSTRUCTION (NEW STRUCTURES OR ADDITIONS) SB, NOT SPRINKLED
 TOTAL SQUARE FOOTAGE OF BUILDING 9,085 SQ FT
 USE OF PROPERTY COMMERCIAL / RESIDENTIAL
 GROSS SQUARE FEET OF COMMERCIAL 3,312 SQ FT
 GROSS SQUARE FEET OF RESIDENTIAL AREA 4,511 SQ FT
 NUMBER OF EMPLOYEES IN WAREHOUSE N/A
 NUMBER OF EMPLOYEES ON PRODUCTION AREA N/A
 CAPACITY OF RESTAURANT / PLACE OF ASSEMBLY N/A
 NUMBER OF BICYCLE STALLS SHOWN 6 OUTSIDE, 6 INSIDE
 NUMBER OF PARKING STALLS (TOTAL SITE):

SHOWN	STALLS REQUIRED	FUD
13	STALLS SHOWN ABOVE GROUND	13
1	ACCESSIBLE	1
14	TOTAL	14

NUMBER OF TREES SHOWN SEE LANDSCAPE PLAN

SITE INFORMATION

SITE SIZE 15,254 SQ FT
 BLDG AREA (FOOTPRINT) 4,515 SQ FT
 FLOOR AREA RATIO 29.9%
 PARKING AND WALKS 8,740 SQ FT
 IMPERVIOUS SURFACE AREA 13,315 SQ FT
 IMPERVIOUS SURFACE RATIO 84.0%
 PARKING RATIO FUD
 ZONING FUD

LEGEND:

- PROPERTY CORNER
- PROPERTY LINE
- SAN SANITARY SEWER
- STM STORM SEWER
- W WATER MAIN
- ⊕ FIRE HYDRANT
- ⊕ UTILITY POLE
- ⊕ UTILITY POLE W/ LIGHT
- MANHOLE
- ⊕ WATER VALVE
- CURB INLET
- STORM SEWER ACCESS COVER
- ⊕ SPOT ELEVATION
- ⊕ MONITORING WELL
- ▨ EXISTING BUILDING

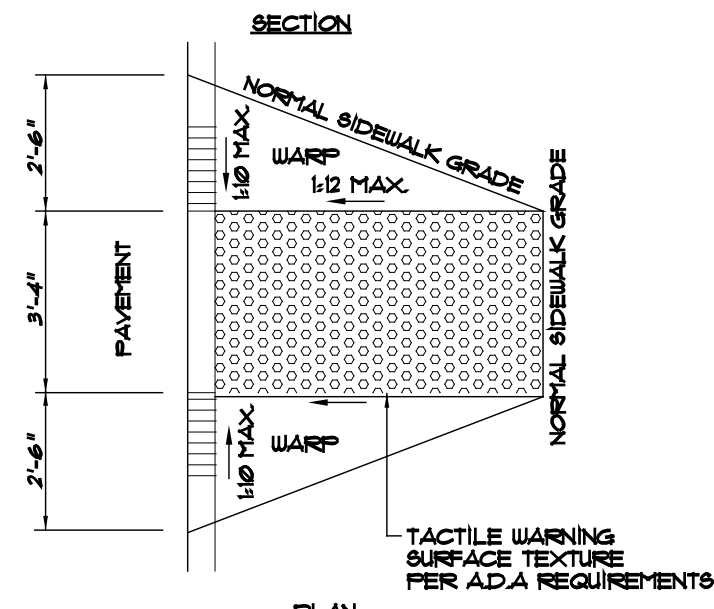
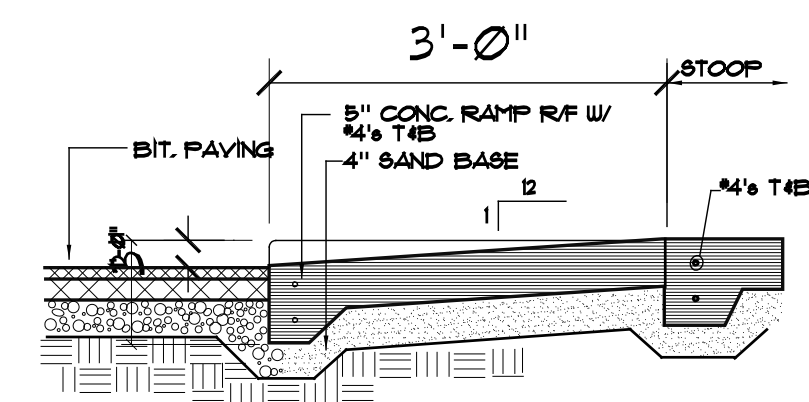

TYPICAL CURB RAMP DETAIL
 C-11 SCALE: 1/8" = 1'-0"

GENERAL NOTES:

- ALL PAINT STRIPPING SHALL BE 4" WIDE, YELLOW
- H.C. CURB CUTS AND RAMPS PER ADA SEC. 4.11 MAX. SLOPE TO BE 1:12, MIN. WIDTH TO BE 36", TRUNCATED DOMES ARE TO BE INSTALLED ON EACH SIDE, DIAMOND MESH SURFACE FULL WIDTH AND DEPTH OF RAMP. SEE DETAIL 2/C-11
- ALL DIMENSIONS ARE FROM FACE OF CONCRETE WALL, FACE OF CURB OR CENTER OF PROPERTY LINE.
- BITUMINOUS PAVING IS 3" SURFACE COURSE ON 6" COMPACTED STONE BASE (APPROXIMATE ASPHALTIC AREA: 7,160 SQ FT)
- ALL EXTERIOR CONCRETE SIDEWALKS TO BE 6" BAG MIX WITH WESTERN FINISH 5" THICK W/ W/F REINFORCING ON 6" COMPACTED FILL (AREA OF SIDEWALKS: 1200 SQ FT)
- WATER SERVICE MATERIAL SHALL BE 2" COPPER
- SEWER AND WATER CONSTRUCTION SHALL BE COMPLETED IN ACCORDANCE WITH THE CITY OF MADISON STANDARD SPECIFICATION FOR PUBLIC WORKS CONSTRUCTION.
- DRIVEWAY APRON CONSTRUCTION WITHIN THE PUBLIC RIGHT OF WAY SHALL BE CONSTRUCTED IN ACCORDANCE WITH CITY OF MADISON STANDARDS
- EXISTING WATER MAIN VALVES SHALL BE MARKED AND PROTECTED FOR DURATION OF CONSTRUCTION
- SLOPES GREATER THAN 3:1 SHALL BE LINED WITH EROSION MATTING
- TRACKED MATERIAL SHALL BE COLLECTED BY THE GENERAL CONTRACTOR AT THE END OF EACH WORKING DAY OR AS REQUIRED BY THE CITY
- ACCESSIBLE SIGNAGE AT THE HEAD OF STALLS SHALL BE A MINIMUM OF 60" INCHES BETWEEN THE BOTTOM OF THE SIGN AND THE GROUND.
- PROVIDE KNOX BOX FOR THE FIRE DEPARTMENT. COORDINATE LOCATION WITH FIRE DEPARTMENT PRIOR TO INSTALLATION.
- ALL "STOP" SIGNS ARE TO BE INSTALLED AT A HEIGHT OF 7 FEET AT ALL DRIVEWAY APPROACHES BEHIND THE PROPERTY LINE

LIGHT FIXTURE KEY

- A** COOPER LIGHTING, INVUE 400W MH SINGLE HEAD PARKING LOT LIGHT FIXTURES MODEL # IC1-T15-MH-200-9L-DP 12'-0" X 4" SQ STEEL POLE ON 3'-0" CONC. BASE (15'-0" FROM GRADE)
- B** COOPER LIGHTING, INVUE ENTRI LED WAL-PAC LIGHT FIXTURE CATALOG # ENC-C01-LED-EI-BL4-DP (9'-0" FROM GRADE)
- C** COOPER LIGHTING, INVUE ENTRI LED WAL-PAC LIGHT FIXTURE CATALOG # ENC-C01-LED-EI-G2U-DP (8'-0" FROM GRADE)



TO OBTAIN LOCATIONS OF PARTICIPANTS UNDERGROUND FACILITIES BEFORE YOU DIG IN WISCONSIN

CALL DIGGERS HOTLINE 1-800-242-8811 TOLL FREE
 WIS STATUTE 90.27(154) REQUIRES 10-3 WORK DAYS NOTICE BEFORE YOU EXCAVATE

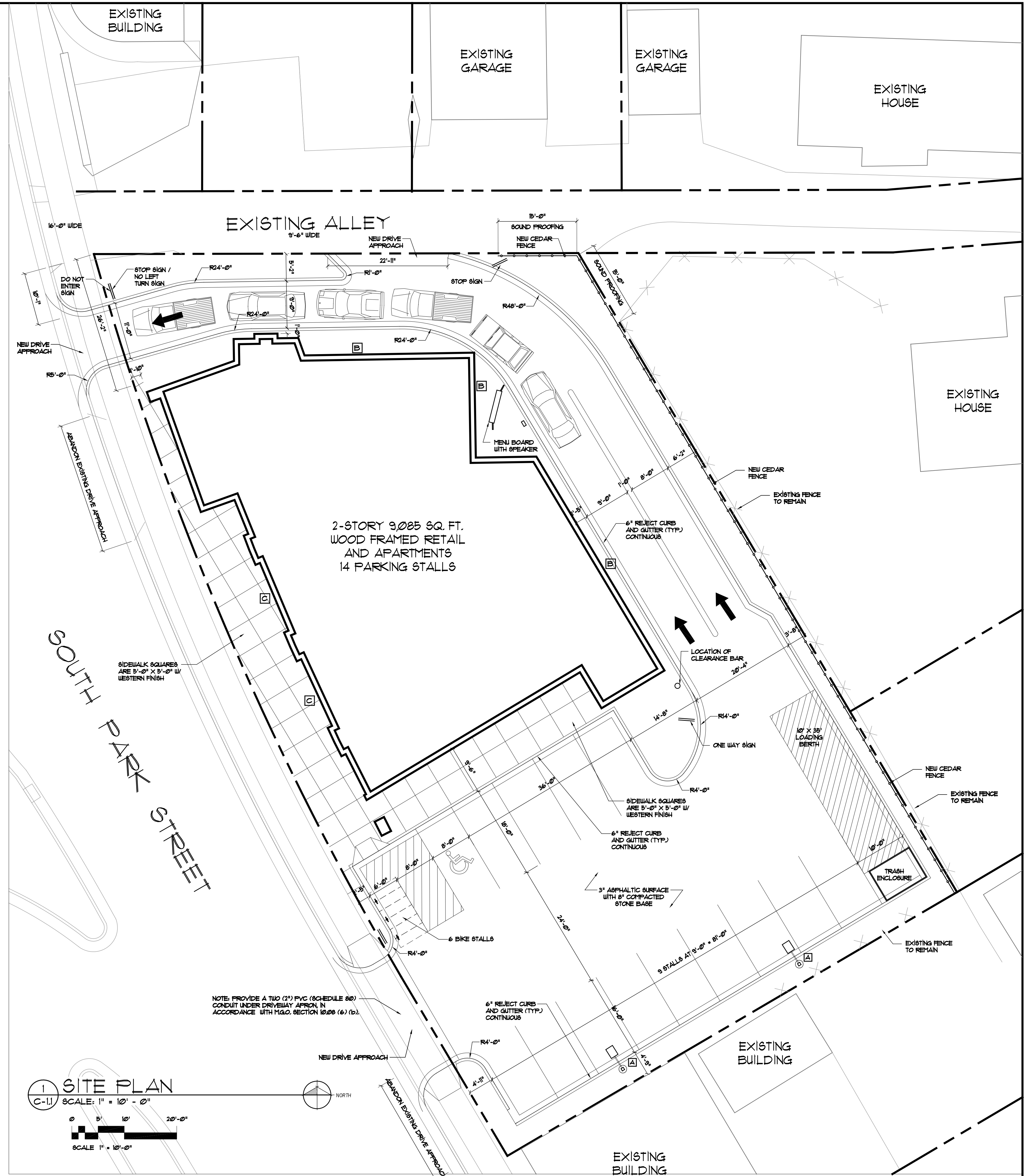

1 SITE PLAN
 C-11 SCALE: 1" = 10'-0"

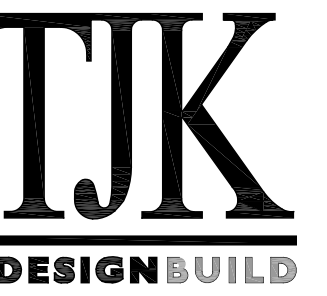
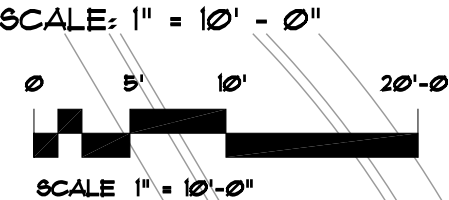

634 West Main Street
 Madison, WI 53103
 608-257-1090
 FAX 608-257-1092

REV DATE

COPYRIGHTED DRAWING
 © 2011 TJK Design Build, Inc. ALL RIGHTS RESERVED. NEITHER THIS DOCUMENT NOR THE INFORMATION HEREIN MAY BE REPRODUCED, DISTRIBUTED, USED OR DISCLOSED IN WHOLE OR IN PART, UNLESS EXPRESSLY AUTHORIZED IN WRITING BY TJK DESIGN BUILD, INC.

PROPOSED FACILITY FOR:
ERIN SQUARE
 801 SOUTH PARK STREET
 MADISON, WISCONSIN

C-11



EXISTING SITE DEMOLITION PLAN

C-1.0 SCALE: 1" = 20' - 0"

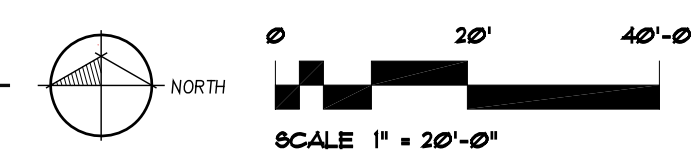

- GENERAL NOTES:**
1. ALL WORK TO BE PERFORMED ON SITE AND ADJACENT RIGHT-OF-WAY TO BE COORDINATED WITH TJK DESIGN, CIVIL AND SOILS ENGINEERS, AND INFORMATION WITHIN CITY OF MADISON CITY ENGINEERING DIVISION PROJECT NUMBER 53B2144 DOCUMENTS.
 2. REMOVE AND DISPOSE OF ALL EXISTING LANDSCAPING, TREES, AND STUMPS.

MATERIAL LIST	
STANDING BEAM ROOF AND SIDING:	COATED METALS GROUP, "CHAMPAIGN"
PREFINISHED METAL FASCIA AND SOFFIT:	COATED METALS GROUP, "DARK BRONZE"
LP SMARTSIDE SIDING:	PANTO MATCH SHERWIN WILLIAMS, "60-0036, "LIBRARY FEATHER"
ALUMINUM CLAD WOOD WINDOWS:	PELLA "DARK BRONZE" ALUMINUM CLADDING WITH LOW-E GLASS
ALUMINUM STOREFRONT & WINDOW SYSTEMS:	KALNEER "DARK BRONZE" ALUMINUM WITH INSULATED LOW-E GLASS, THERMAL BREAKS IN FRAME
FIELD BRICK:	ENDICOTT CLAY PRODUCTS CO. MEDIUM IRON SPOT #1 UTILITY SIZE VELOUR FINISH WITH COLORED MORTAR IN ACCENT COLOR
METAL PIPE RAILING:	PANTO MATCH SHERWIN WILLIAMS "60-6336, "FRED BRICK"



1 PARK STREET ELEVATION
A-2.1 SCALE: 1/8" = 1' - 0"

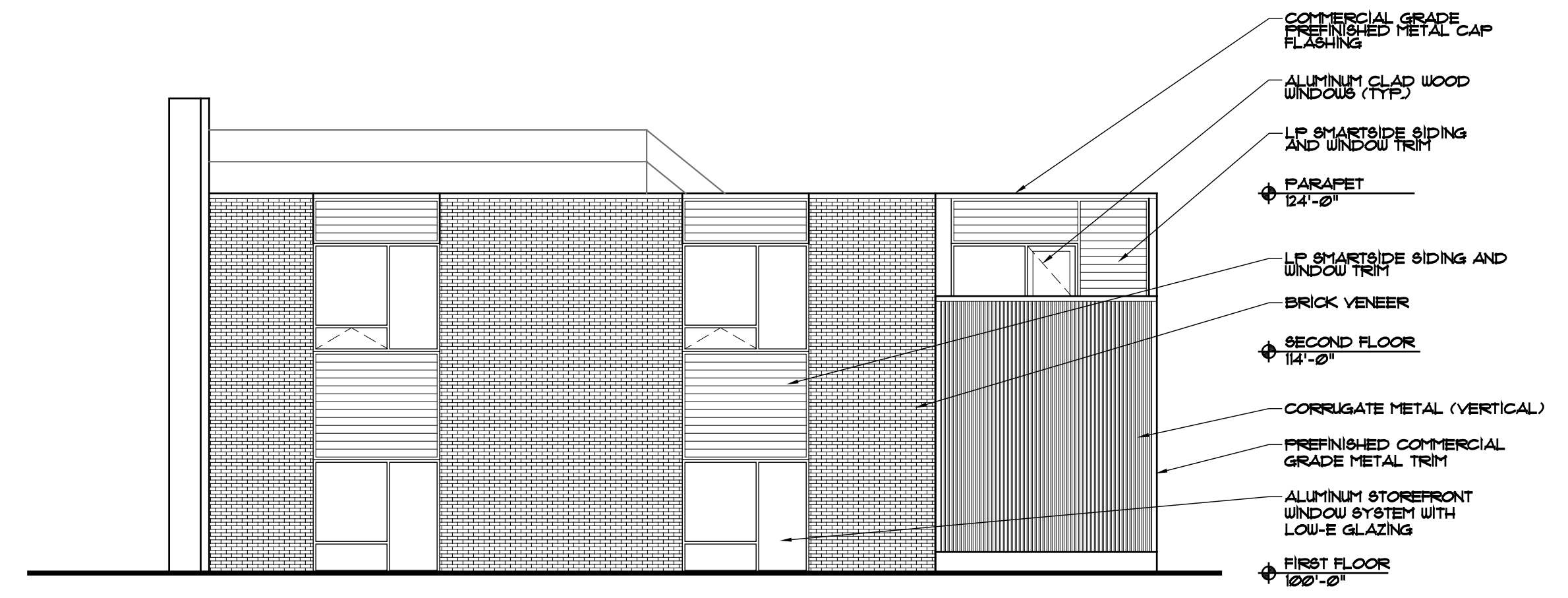

2 PARKING LOT ELEVATION
A-2.1 SCALE: 1/8" = 1' - 0"

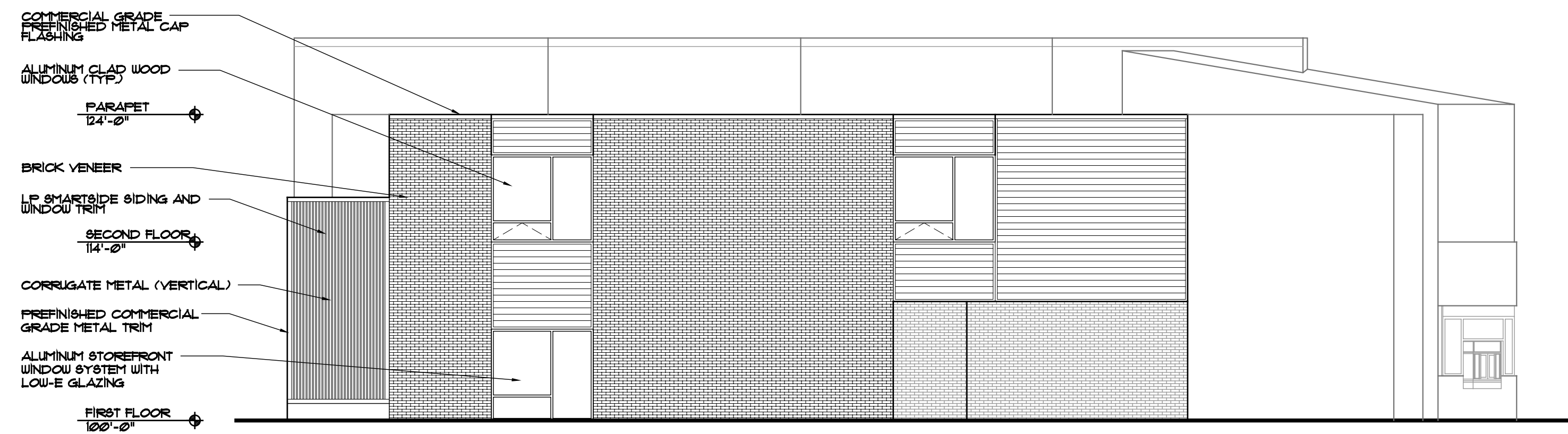

3 BACK ELEVATION
A-2.1 SCALE: 1/8" = 1' - 0"



4 DRIVE-THRU ELEVATION
A-2.1 SCALE: 1/8" = 1' - 0"

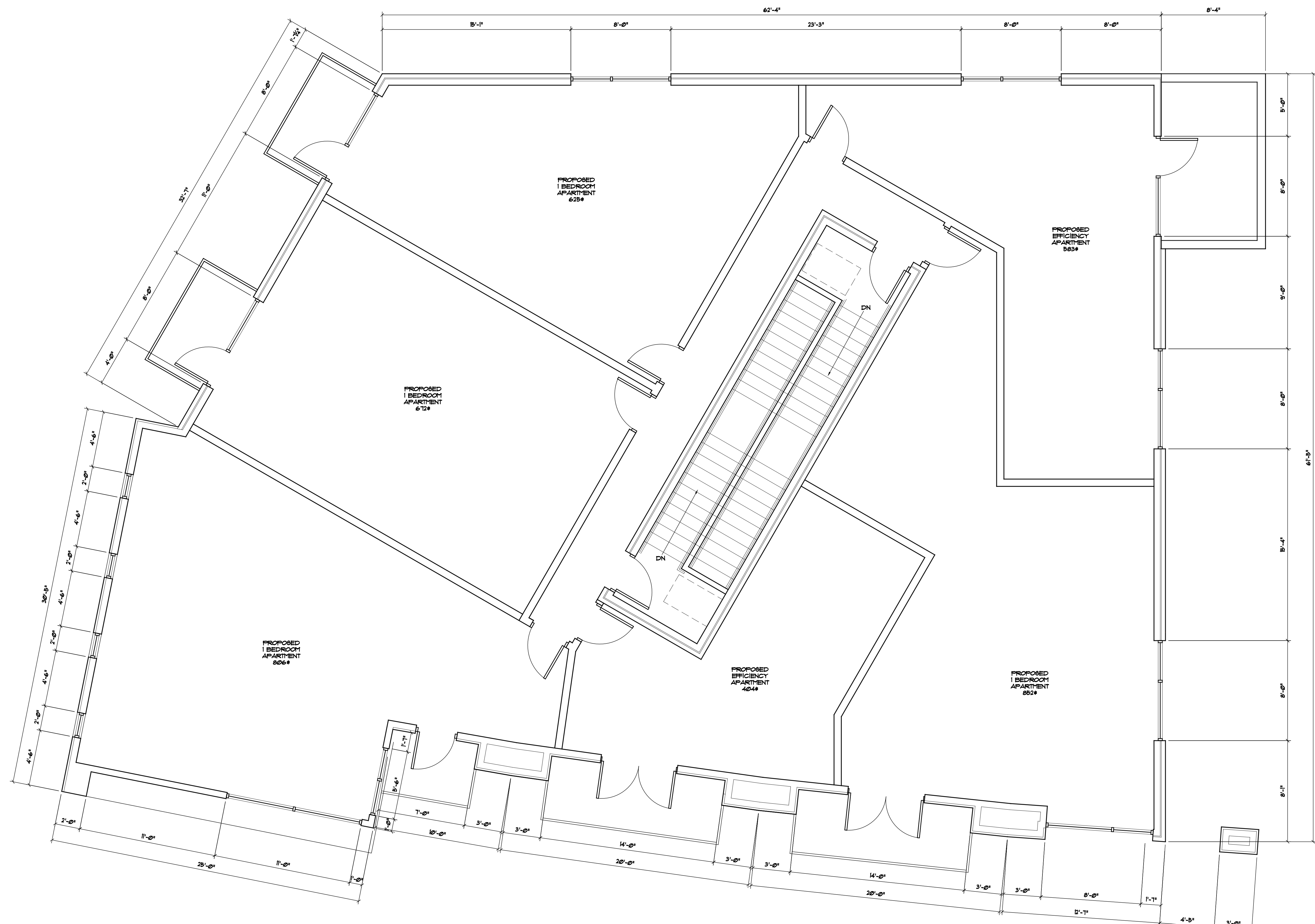

1 2ND FLOOR PLAN
 A-12 SCALE: 1/4" = 1' - 0"
 NORTH

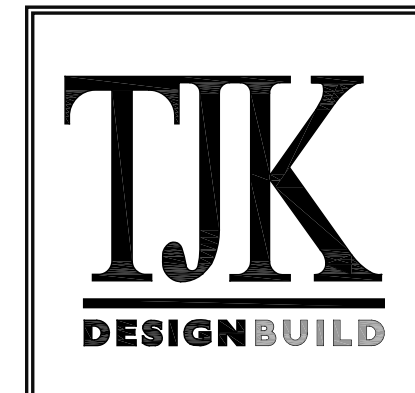

634 West Main Street
 Madison, WI 537103
 608-251-1090
 FAX 608-251-1092

REV	DATE

COPYRIGHTED DRAWING
 © 2011 TJK Design Build, Inc. ALL RIGHTS RESERVED. NEITHER THIS DOCUMENT NOR THE INFORMATION HEREIN MAY BE REPRODUCED, DISTRIBUTED, USED OR DISCLOSED IN WHOLE OR IN PART, UNLESS EXPRESSLY AUTHORIZED IN WRITING BY TJK DESIGN BUILD, INC.

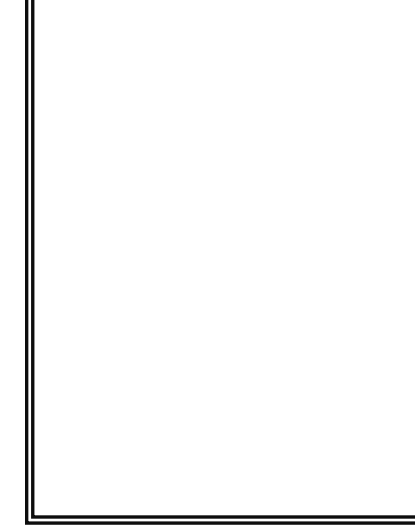

PROPOSED FACILITY FOR:
ERIN SQUARE
 801 SOUTH PARK STREET
 MADISON, WISCONSIN

A-12
 4.3.12

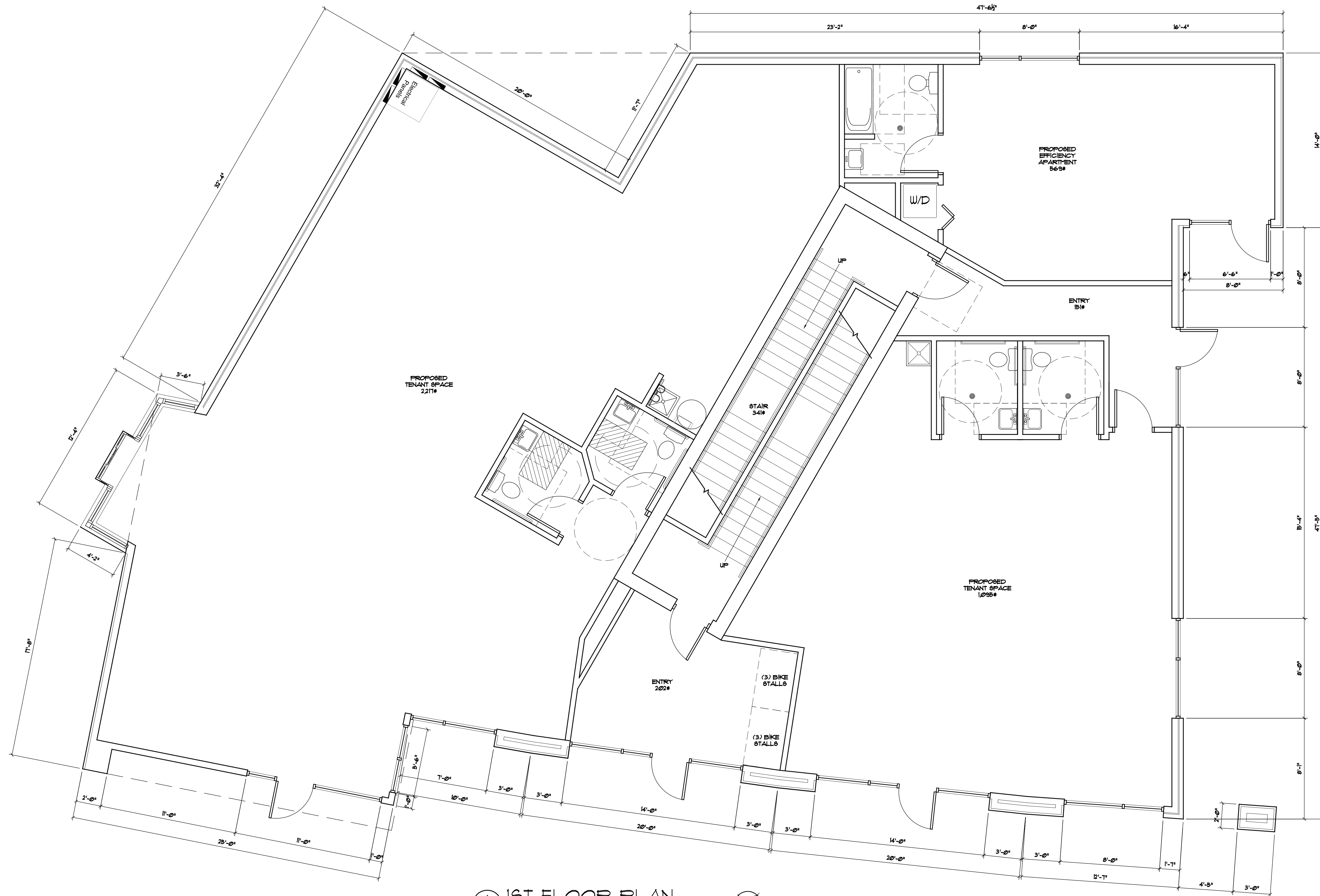

1 1ST FLOOR PLAN
A-1.1 SCALE: 1/4" = 1' - 0"
NORTH