

From: [Scanlon, Amy](#)
To: [Scanlon, Amy](#)
Subject: FW: 4/27/15 Landmarks Commission
Date: Thursday, May 07, 2015 8:15:29 AM

From: Anne Schuelke [mailto:acschuelke.tregre@gmail.com]
Sent: Thursday, April 30, 2015 10:13 AM
To: Chris JordanXT
Cc: Scanlon, Amy; Adam Tregre; Rummel, Marsha
Subject: Re: 4/27/15 Landmarks Commission

Hi Amy,

The following is a catalog for 3 inch siding that is of higher quality than other options we'd looked into in the past:

http://www.certainteed.com/resources/VS_RestClassic_Brochure_CTS448.pdf

There is also a product called "vinyl carpentry" that has accents and trim pieces that are more decorative:

<http://www.certainteed.com/resources/CTS160.pdf>

There is also a product called Restoration Millwork. It cuts, mills, shapes, and routes like lumber and can be painted with vinyl-safe paint:

<http://www.certainteed.com/resources/CTS373.pdf>

Regarding the porch corners, Chris has some less-than-perfect options he can discuss.

On Tue, Apr 28, 2015 at 11:18 AM, Chris JordanXT <chris@jordanexteriors.com> wrote:
Good Morning Amy

Anne has asked me to forward the pictures of the 3" siding for the front of the building and for the scallops.

Sincerely

Chris Jordan
Jordan Exteriors
[608-215-6678](tel:608-215-6678)
www.jordanexteriors.com

CertainTeed
Decorative Trim

Vinyl Carpentry®

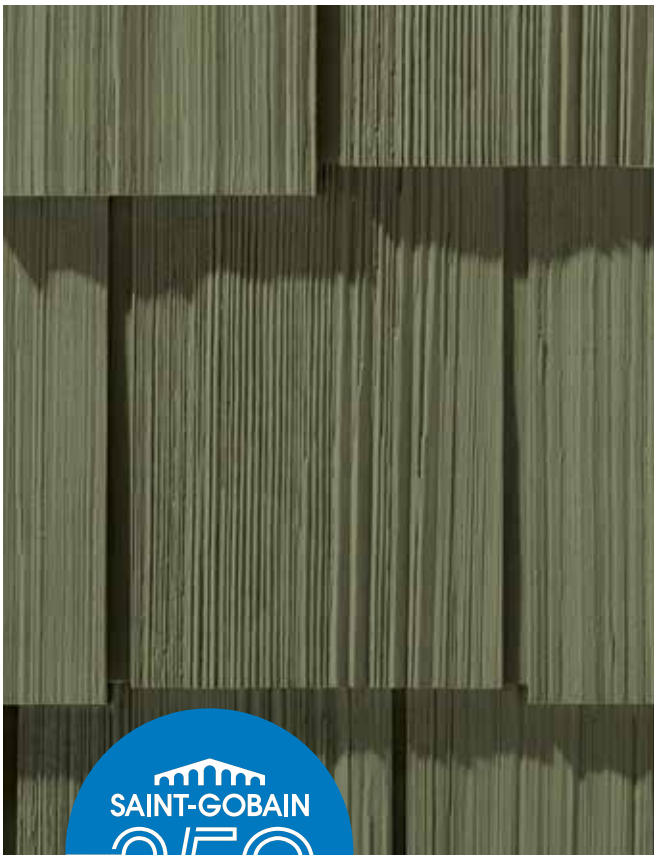

1665 - 2015

CertainTeed
SAINT-GOBAIN



Certa-Snap® Wrap
Post Wrap System



3-1/2" Cornerpost



J-Channel



J-Channel with
Aluminum Rake



From Simple...

... to Stunning!



Panorama®
composite railing,
white with steel
straight balusters,
antique bronze



Restoration Millwork®
Classic Column Wraps

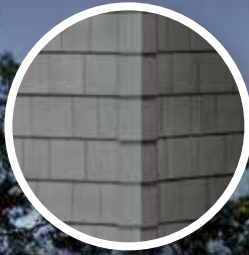

Cedar Impressions®
Perfection Mitered
Cornerpost



Vinyl Carpentry®
Cornice Molding and
Restoration Millwork
Rake Profile



Vinyl Carpentry®
Lineals with
Crown Molding



Vinyl Carpentry®
Traditional
SuperCorner



Add good taste to your home's exterior with finishing touches that create eye-popping, stop-and-stare curb appeal. CertainTeed Vinyl Carpentry® Decorative Trim options, products and ideas make it easy. From unadorned to unbelievable,

simple to stunning, drab to distinctive, basic to incredibly beautiful, CertainTeed assures that with the endless style and color possibilities of decorative trim, your home will never be without a personality and style all its own.

CertainTeed has the most complete siding accessory line in the industry. Virtually every installation challenge imaginable can be addressed with CertainTeed's extensive assortment.

Using the proper accessories can make for an ease of installation, but that's not all. Choosing the proper accessories can guarantee optimum performance, design flexibility and aesthetic enhancement. For detailed installation information, please refer to the CertainTeed Vinyl Siding Installation Guide (CTS205).

Window & Door Trim

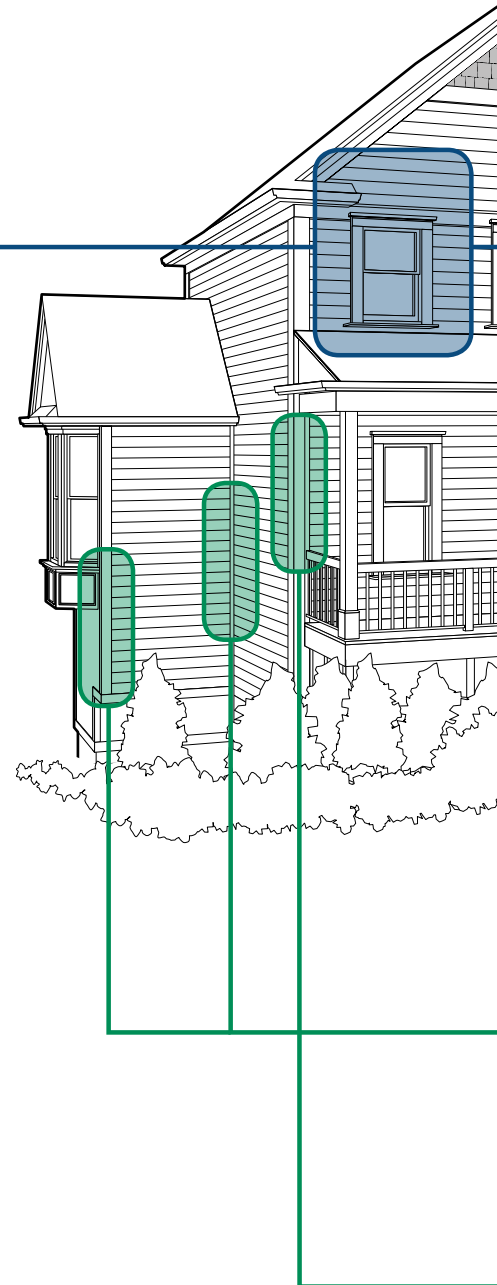
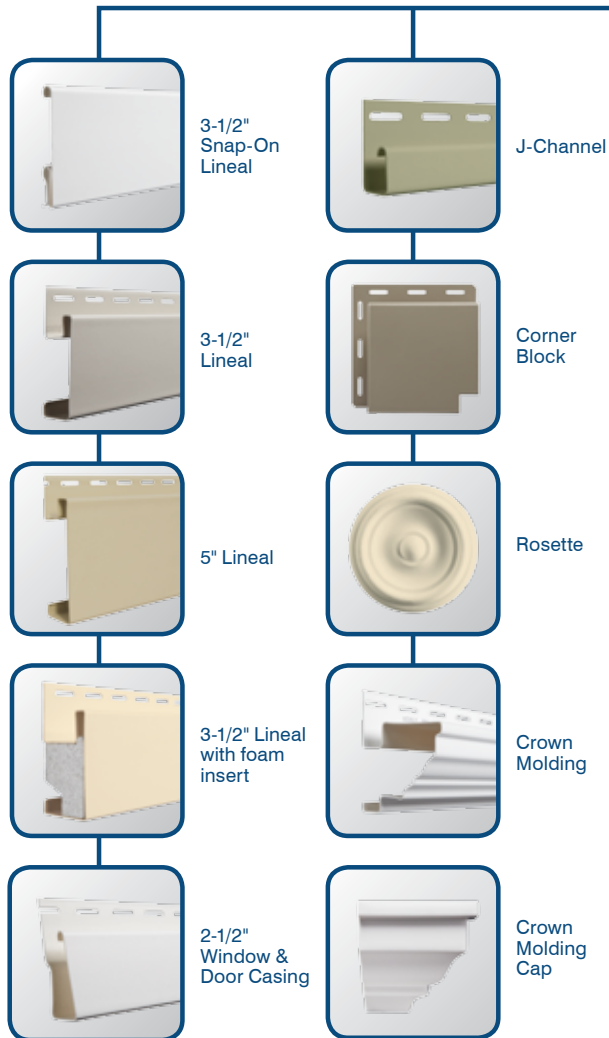



Accents

Cedar Impressions® and Board & Batten



Triple 5" Straight Edge Perfection Shingles



Double 7" Straight Edge Perfection Shingles



Double 7" Staggered Perfection Shingles



Double 7" Straight Edge Rough-Split Shakes



Double 9" Staggered Edge Rough-Split Shakes



Double 6-1/4" Half-Round Shingles



Board & Batten



Wall & Soffit Transitions



Cornice Molding



Cornice Molding Cap



Finish Board

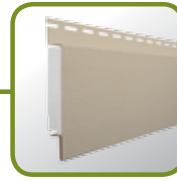

Band Board with foam insert



Soffit Cove Trim



H-Bars

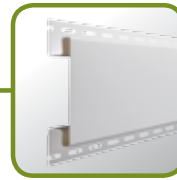

Double Channel Lineals



Corner Systems

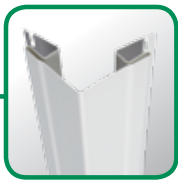

Cornerposts



Beaded SuperCorner with foam insert

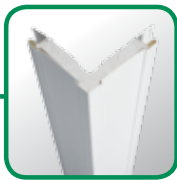

Traditional SuperCorner with foam insert



Fluted SuperCorner with foam insert

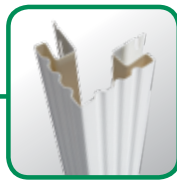

3/4" Fluted Corner

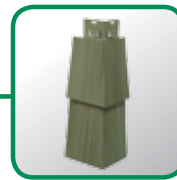

Cedar Impressions T5", D7", D9 Mitered Cornerposts



Cedar Impressions D7" Straight Edge Perfection Mitered Inside Cornerpost



4-Piece Corner using corner starter, two lineals and a quarter-round insert

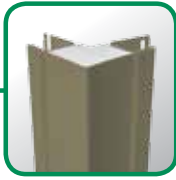

1-1/4" Cornerpost with foam insert



Inside Cornerposts

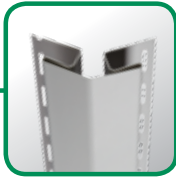

Bay Window Cornerpost

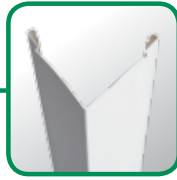

5" Corner Cap



Cedar Impressions S7" Mitered Bay Window Outside Cornerpost



Cedar Impressions S7" Mitered Bay Window Inside Cornerpost



Window & Door Trim..... 8

- Corner Block & Rosette
- Crown Molding
- J-Channels
- Lineals
- Snap-On Lineal



Corner Systems 14

- 4-Piece Corner Systems
- Bay Window Cornerpost
- Corner Cap
- Inside Cornerposts
- Insulated Cornerposts
- Mitered Cornerposts
- Outside Cornerposts
- SuperCorners™



Accents.....

- Board & Batten
- Cedar Impressions®



..... 24

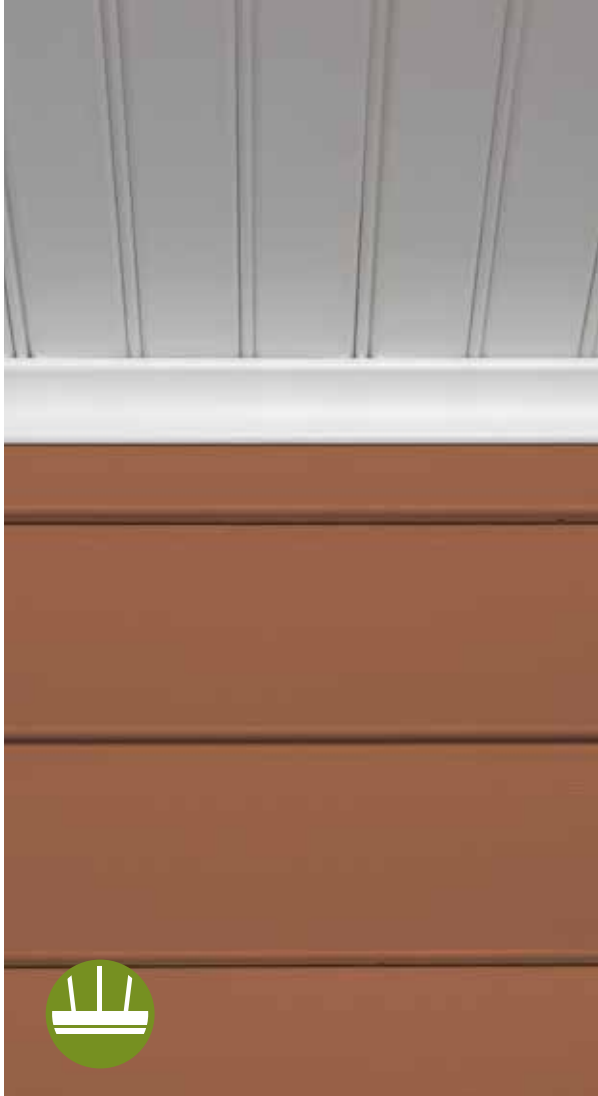

Wall & Soffit Transitions 30

- Band Board
- Cornice Molding
- Double Channel Lineals
- Finish Board
- H-Bars
- Lineals
- Soffit Cove Trim



Color Chart 36

Finding Your Color..... 38

Trim and Color Selector Tools 39

CertainTeed has created a variety of user-friendly visualization tools to help you get a better idea of how well different colors and styles work together.

2-1/2" Window & Door Casing

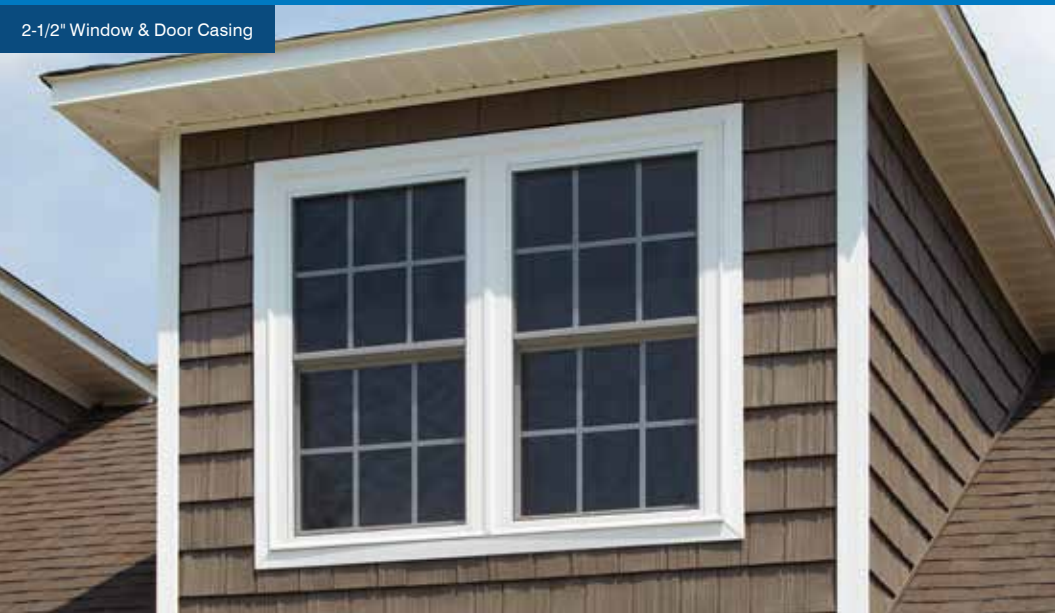

3-1/2" Lineal



3-1/2" Lineal with Crown Molding



2-1/2" Window & Door Casing





Window & Door Trim

3-1/2" Lineal with Crown Molding



CertainTeed window and door trim puts out the welcome mat to create a lasting first impression. Lineal trim adds a wider face profile that can help unify and accent a home's exterior, adding a design element that can be both subtle and distinctive. For even more personality and charm, add crown molding, with or without a corner block & rosette above the door or window. It's a look you'll appreciate every time you cross the threshold into your beautiful home.



Explore Your Options

From window and door casing to lineals, CertainTeed offers a complete selection of virtually maintenance-free Vinyl Carpentry® to define your home.

Fast facts:

Rosettes are circular decorative elements found in early Greek monuments, but also found on Federal-style architecture homes built in the early 17th/late 18th century.

Crown molding dates back to the time of the ancient Greeks and Romans, used for "crowning" an architectural element.

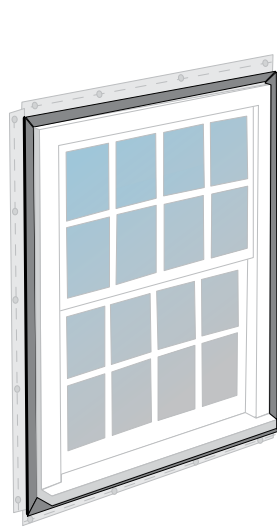

Simple

3/4" pocket J-channel surround.

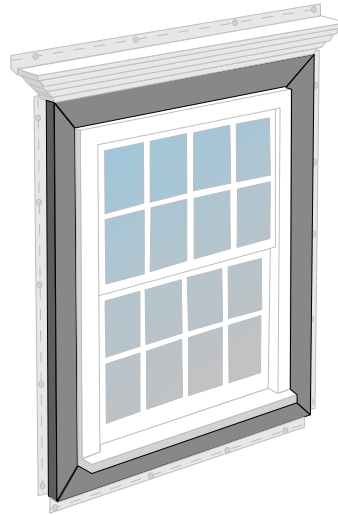

More Definition

Crown molding and crown molding end caps with 3-1/2" lineal header and 3-1/2" lineal surrounds.

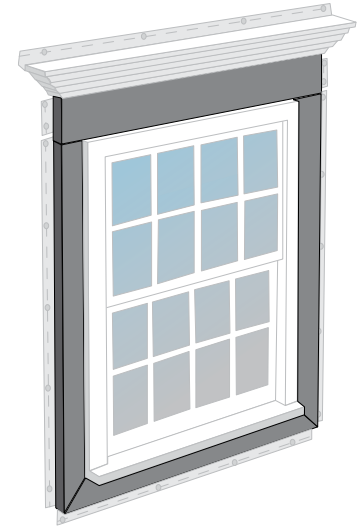

Classic Enhancement

Crown molding and crown molding end caps with 5" lineal header, 5" header end caps* and 3-1/2" lineal surrounds.

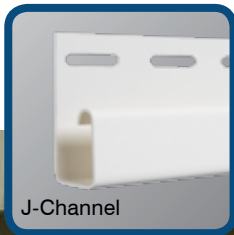

J-Channel

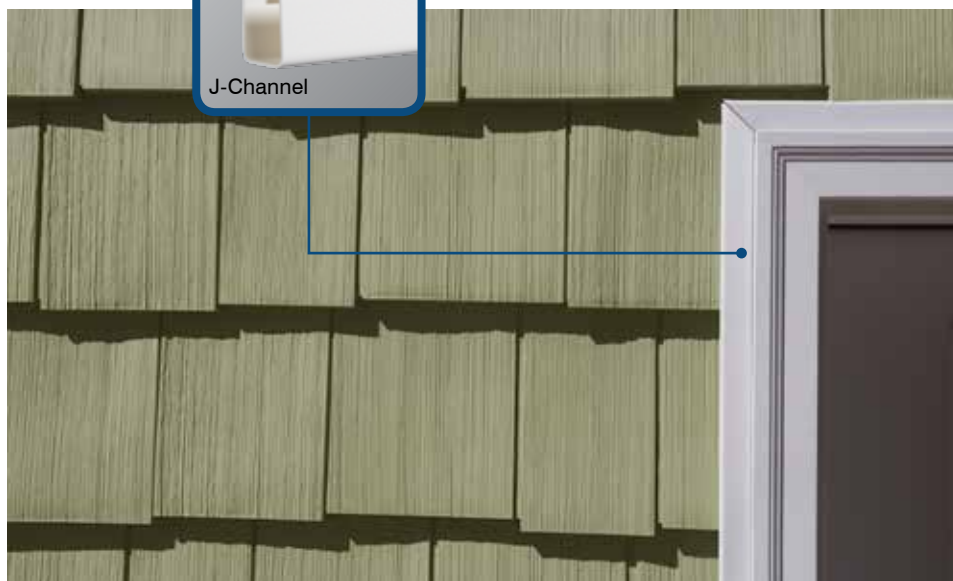

3-1/2" Lineal



5" Lineal

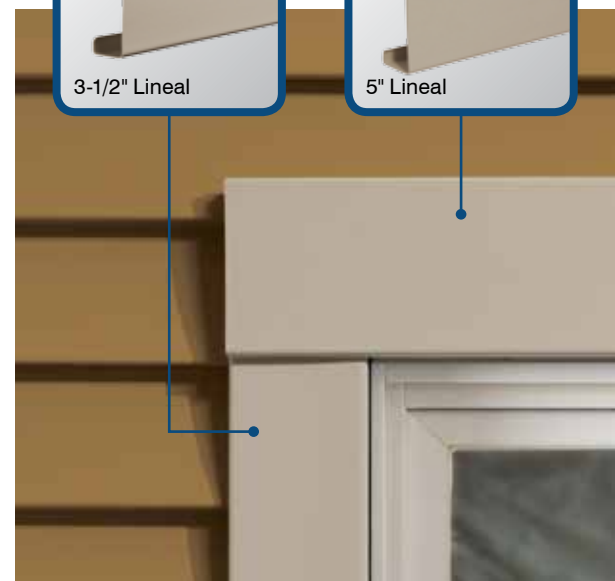

* Fabricated on site. Please refer to install manual CTS205 for complete instructions.



Crown Molding



Crown Molding Cap



3-1/2" Lineal



Rosette



Corner Block

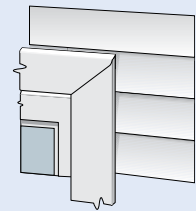

2-1/2" Window and door casing

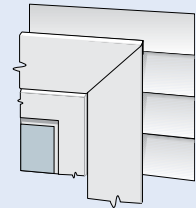

3-1/2" Lineal System

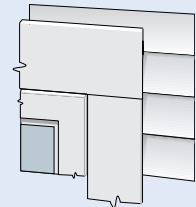

5" Lineal header, 3-1/2" vertical Lineal

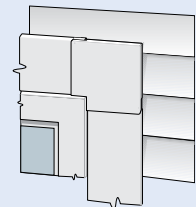

3-1/2" Lineal System with corner block

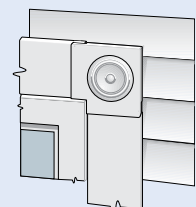

3-1/2" Lineal System with corner block and rosette

Using combinations of lineals or adding a corner block offers that little touch to add personality on any home.

Select Your Products

3-1/2" Snap-On Lineal

Lineals snap onto 1" face J-Channel; eliminates nailing and rain tabs.

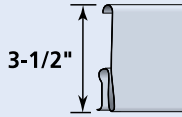

Product Code: 54709

Finish: Matte
Length: 12' 6"
Pieces/Ctn: 24
Lin Ft/Ctn: 300
Cartons/Pallet: 42
lbs/Ctn: ≤ 55
Colors Available:

S CW

3-1/2" Lineal with foam insert

For use with CedarBoards™ siding and Cedar Impressions® D9 shakes, D7 Straight Edge Shakes and Northwoods.

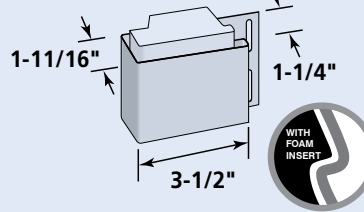

Product Code: 54707

Finish: Matte
Length: 20'
Pieces/Ctn: 10
Lin Ft/Ctn: 200
Cartons/Pallet: 23
lbs/Ctn: ≤ 63
Colors Available:

GG SG CYP SNB DT
NC SW LM HC S
CW

3-1/2" Lineal

For use with a new construction window and door starter around windows and doors as a casing. The 3/4" channel receives siding panels. Can also be used to create a corner system.

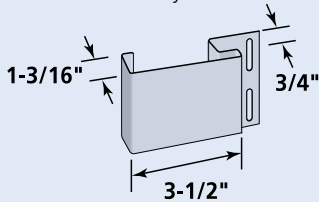

Product Code: 54706

Finish: Matte
Length: 20'
Pieces/Ctn: 10
Lin Ft/Ctn: 200
Cartons/Pallet: 30
lbs/Ctn: ≤ 51
Colors Available:

IG PB GG SG SEA
CYP HB SB DT NC
SW LM HC S CW

2-1/2" Window & Door Casing

A wide face J-channel with accentuates windows and doors. Designed to accommodate new construction window flanges and fit snugly against window and door frames.

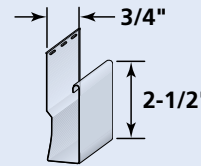

Product Code: 55813

Finish: Matte
Length: 12' 6"
Pieces/Ctn: 20
Lin Ft/Ctn: 250
Cartons/Pallet: 24
lbs/Ctn: ≤ 52
Colors Available:

S CW

5" Lineal

Two lineals create a corner system when installed with a Corner Starter and a corner insert. Can also be used with a window starter strip as a window/door casing. The 3/4" channel receives siding panels.

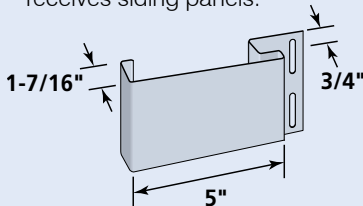

Product Code: 54712

Finish: Matte
Length: 20'
Pieces/Ctn: 10
Lin Ft/Ctn: 200
Cartons/Pallet: 15
lbs/Ctn: ≤ 64
Colors Available:

HB SB DT NC SW
S CW

3-1/2" Corner Block Channel

Fits at window corners and receives 3-1/2" lineals.

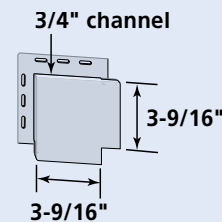

Product Code: 55802

Finish: Matte
Pieces/Ctn: 20
Cartons/Pallet: 60
lbs/Ctn: ≤ 4
Colors Available:

SNB DT NC S CW

Rosette

Snaps onto corner block for decorative window treatment.

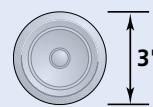

Product Code: 55803

Finish: Matte
Pieces/Ctn: 20
Cartons/Pallet: 60
lbs/Ctn: ≤ 1
Colors Available:

SNB DT NC S CW



Crown Molding

Used in conjunction with 5" or 3-1/2" lineals and 3/4" J-channel to create a custom molded window or door header.

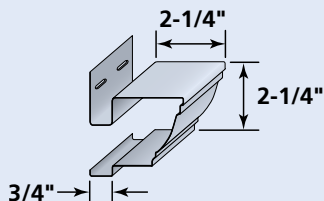

Product Code: 55804

Finish: Matte
 Length: 10'
 Pieces/Ctn: 10
 Lin Ft/Ctn: 100
 Cartons/Pallet: 12
 lbs/Ctn: ≤ 35
 Colors Available:

S CW

Dual Undersill Trim

Secures trimmed siding panels under windows and eaves regardless of the profile or where in the panel face the panel has been trimmed.

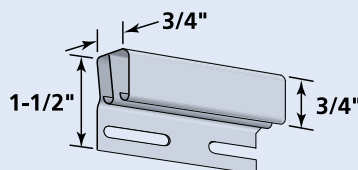

Product Code: 56916

Finish: Matte
 Length: 12' 6"
 Pieces/Ctn: 12
 Lin Ft/Ctn: 150
 Cartons/Pallet: 84
 lbs/Ctn: ≤ 22
 Colors Available:

SDE GG SG BB OB
 SEA CYP GT LIN SA
 WS HB SNB DT NC
 SW LM BS SP HC
 AY S CW

Crown Molding Cap

Seals the ends of a crown molding length.

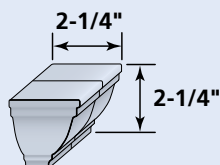

Product Code: 55805

Finish: Matte
 Pairs/Ctn: 10
 Cartons/Pallet: 60
 lbs/Ctn: ≤ 2
 Colors Available:

S CW

3/4" Flexible J-Channel

Specialized 3/4" siding receiving trim; particularly useful around curved windows and ventilation treatments.

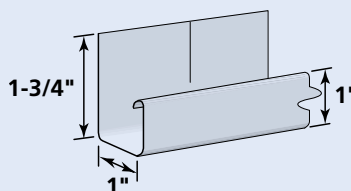

Product Code: 50309

Finish: Matte
 Length: 12' 6"
 Channel: 3/4"
 Pieces/Ctn: 10
 Lin Ft/Ctn: 125
 Cartons/Pallet: 50
 lbs/Ctn: ≤ 20
 Colors Available:

GRY BEI CLY WHT

Undersill Trim

Helps secure trimmed siding panels under windows and eaves. 1/4" (56904), 3/8" for Cedar Impressions (56917).

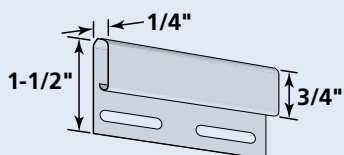

Finish: Matte
 Length: 12' 6"
 Colors Available:
 see page 36

J-Channel

Universal siding and soffit receiving channel for use around utility openings, under eaves, etc. Available in 3/8" (50306), 1/2" (50305), 5/8" (50310), 3/4" (50303), 1" (50302) and 1-1/4" (50301) widths.

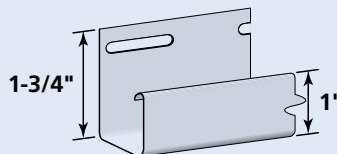

Finish: Matte
 Length: 12' 6"
 Pieces/Ctn: 40-48
 (depending on size)
 Colors Available:
 see page 36

D7" Straight Edge Perfection Mitered Cornerpost



4-Piece Corner System

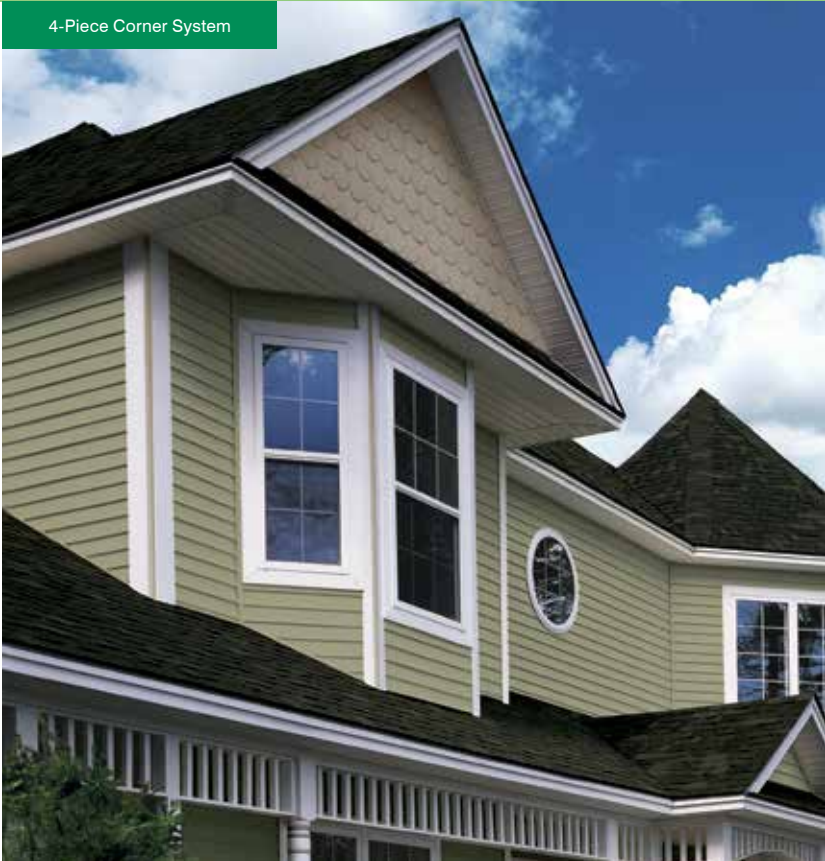

Cornerpost and Inside Cornerpost





Corner Systems

Beaded SuperCorner



Take your home from ordinary to extraordinary. Don't settle for traditional narrow corner trim with no depth. Go for something distinctive and beautifully unique. Blend traditional lap siding seamlessly around every bend with Vinyl Carpentry® Corner Systems or Cedar Impressions® Shakes and Shingles with inside and outside mitered corners. Use a 4-piece corner system to add a contrasting or coordinating color. Create elegance with an edge by adding corner systems and treatments that frame your home with distinction.

Corner Systems

Traditional SuperCorner



Explore Your Options

Fast fact:

The average home has 88 linear feet of corner posts.

linear ft.

From outside corners to inside corners, from subtle to bold, CertainTeed provides the options to define the corners of any house.



Simple

Traditional Cornerpost with matching siding color for less definition.



More Definition

Traditional SuperCorner™ with foam insert creates more definition with a wide 6" face.



Classic Enhancement

4-piece corner in colonial white. Quarter round insert allows you to add contrasting color.

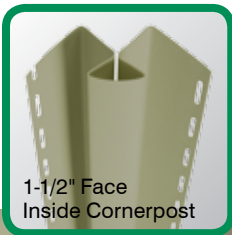

1-1/2" Face Inside Cornerpost

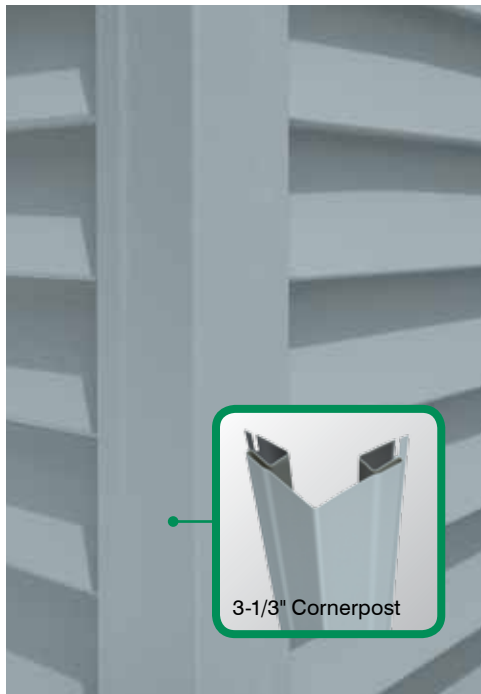
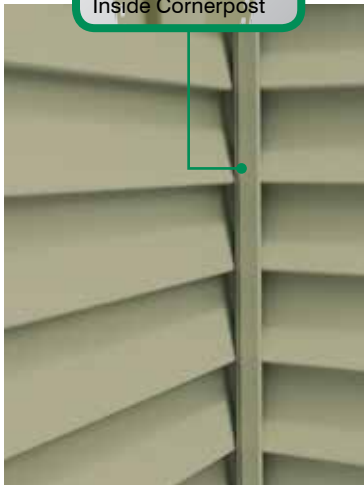

3-1/3" Cornerpost

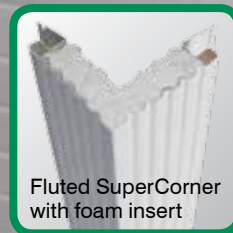
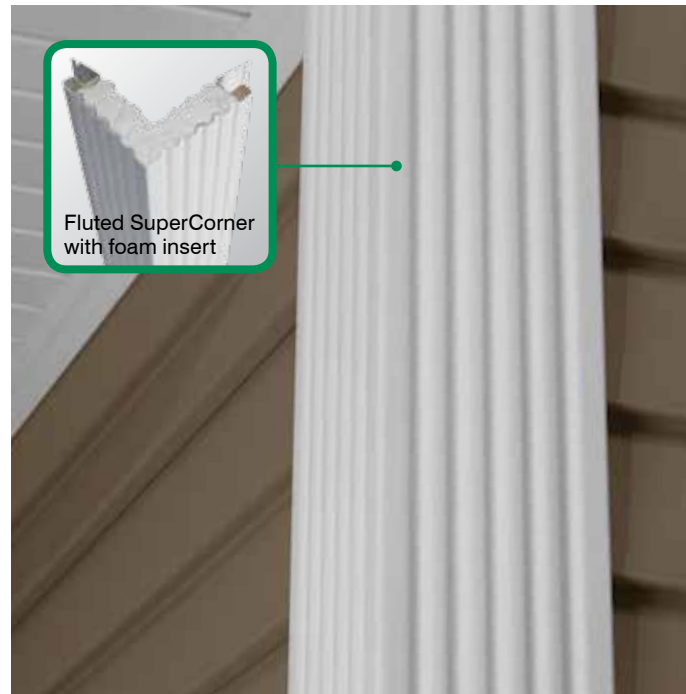

Fluted SuperCorner with foam insert

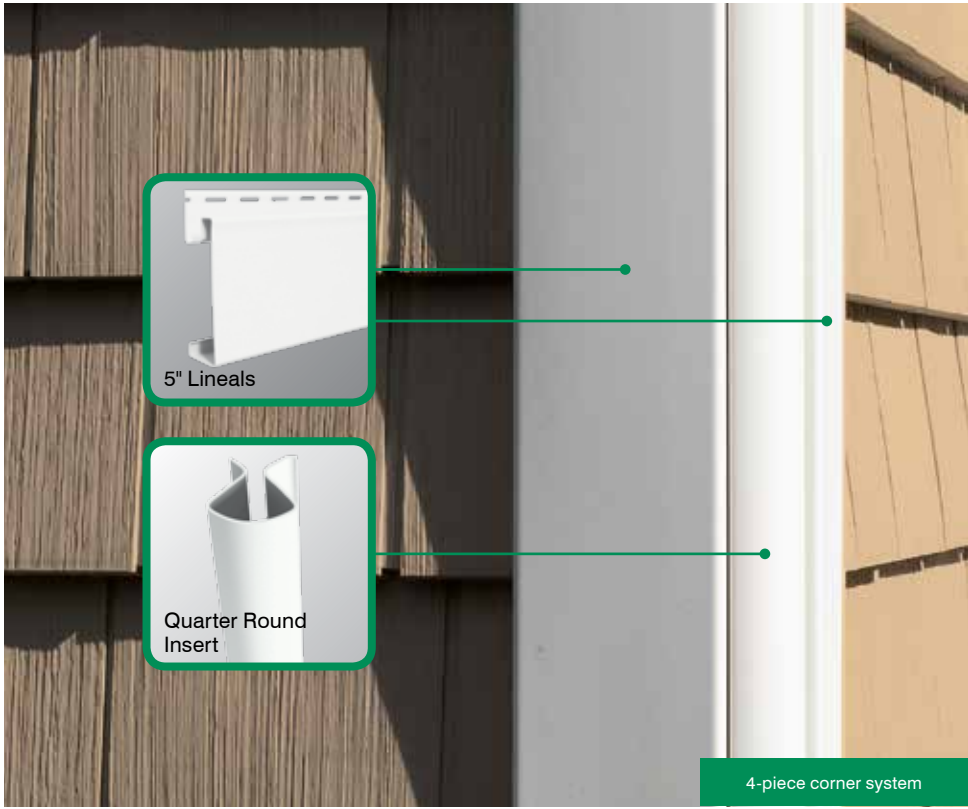

Starter strips are required to build 4 piece corners and federal corners.

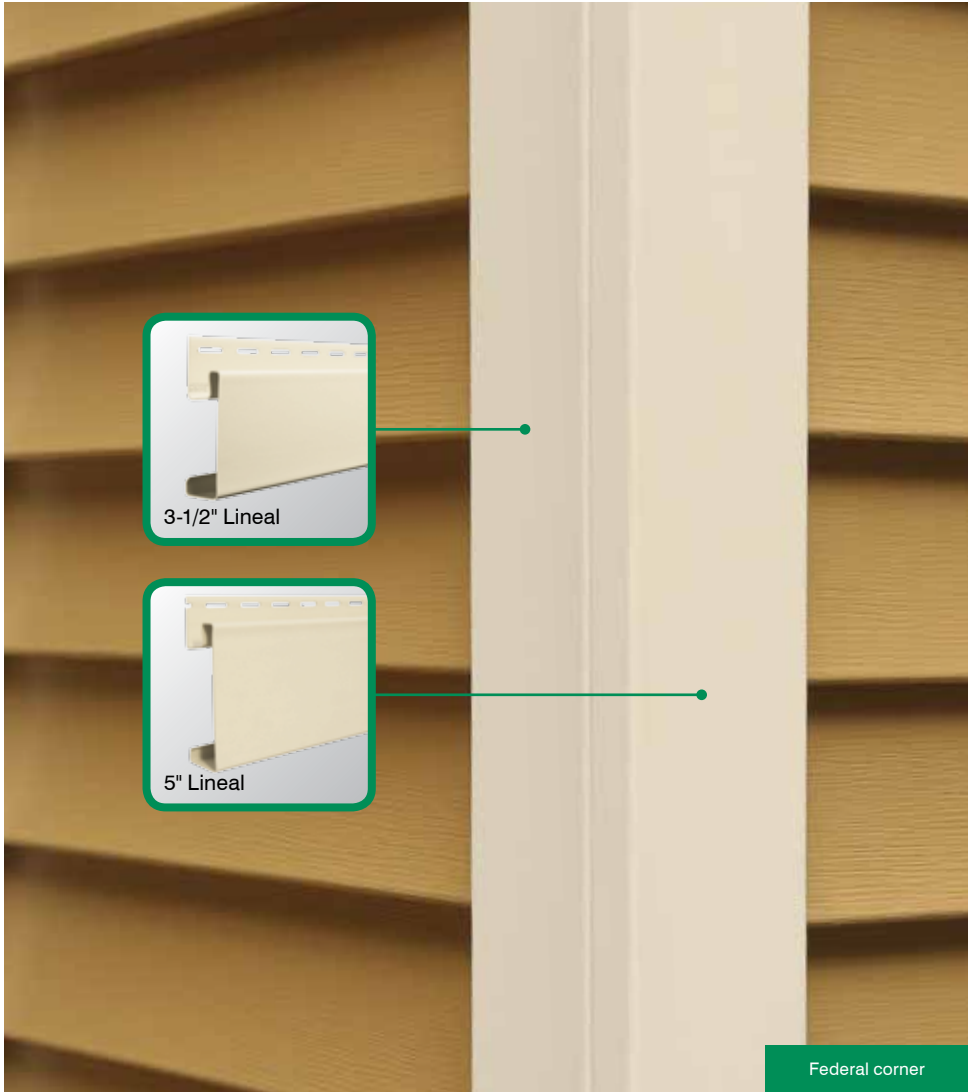

Starter strips are required to build 4 piece corners and federal corners.

In addition to the traditional one-piece corners, lineals can be combined to create inside and outside corners.

4-Piece Corner System

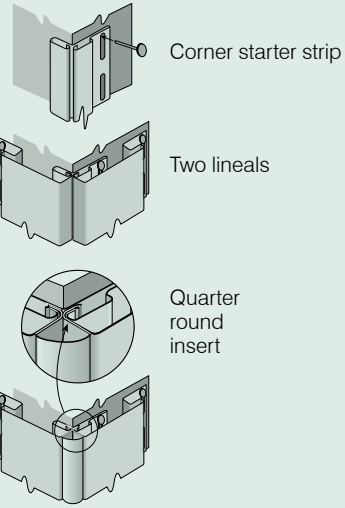

Federal Corner

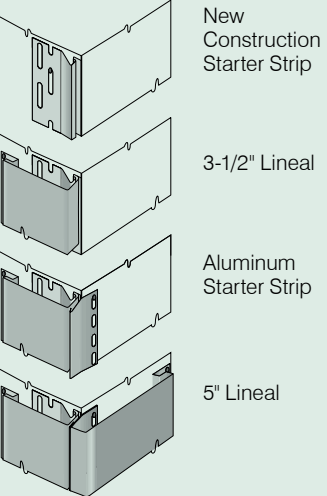

Inside Federal Corner

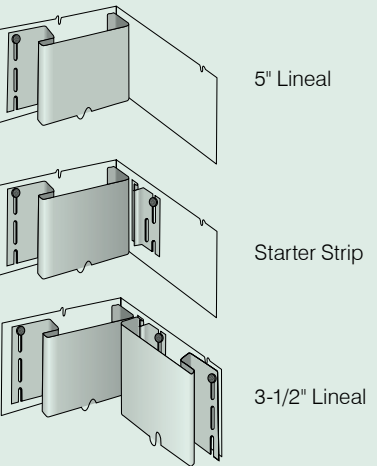

Select Your Products

Cornerpost

Standard corner receives siding panels. Available with 3/4" receiving channels (51401 / 51402 / 51458 / 51404) and 1" receiving channel with 3-1/2" flat face (51409).

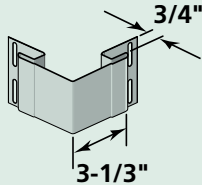

Colors Available:
see page 36

Inside Cornerpost

Used where siding meets inside corners; provides a finished look. 3/4" channel (51436), 1-1/4" channel (51446).

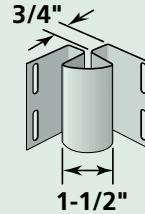

Finish: Matte
Length: 10'
Colors Available:
see page 36

Fluted Corner

Standard corner with fluted design.

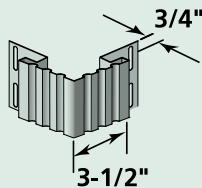

Product Code: 51423

Finish: Matte
Length: 10'
Face: 3-1/2"
Pieces/Ctn: 10
Lin Ft/Ctn: 100
Cartons/Pallet: 12
lbs/Ctn: ≤ 48
Colors Available:

CW

Beaded SuperCorner™ with foam insert

Wide decorative beaded corner treatment with foam backing.

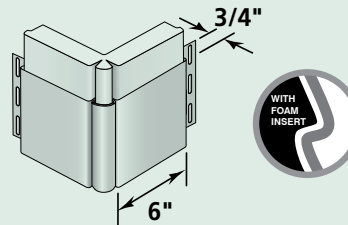

Product Code: 51416

Finish: Matte
Length: 20'
Pieces/Ctn: 6
Lin Ft/Ctn: 120
Cartons/Pallet: 8
lbs/Ctn: ≤ 95
Colors Available:

CW

1-1/4" Cornerpost – 10' Woodgrain with foam insert

For use with CedarBoards™ siding and Cedar Impressions® D9 shakes, D7 Straight Edge Shakes and Northwoods.

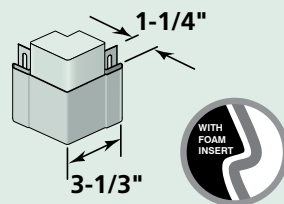

Product Code: 51412

Finish: Woodgrain
Length: 10'
Face: 3-1/3"
Pieces/Ctn: 10
Lin Ft/Ctn: 100
Cartons/Pallet: 12
lbs/Ctn: ≤ 42
Colors Available:

- | | | | | |
|----|-----|----|-----|-----|
| AB | FB | TB | AR | TC |
| MC | SB | HS | SDE | SPR |
| F | IG | PB | FS | CG |
| GG | SG | OB | SEA | CYP |
| HB | SNB | DT | NC | SW |
| LM | BS | SP | HC | AY |
| S | CW | | | |

Traditional SuperCorner™ with foam insert

Wide decorative traditional corner treatment with a foam backing.

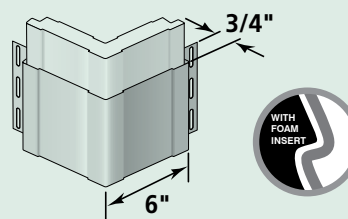

Product Code: 51420

Finish: Matte
Length: 20'
Pieces/Ctn: 6
Lin Ft/Ctn: 120
Cartons/Pallet: 9
lbs/Ctn: ≤ 77
Colors Available:

- | | | | | |
|----|----|-----|-----|----|
| GG | SG | CYP | SNB | DT |
| NC | SW | LM | HC | S |
| CW | | | | |



1-1/4" Traditional SuperCorner™ with foam insert

Can be used with CedarBoards siding and Cedar Impressions D9 Shakes, D7 Straight Edge Shakes and Northwoods.

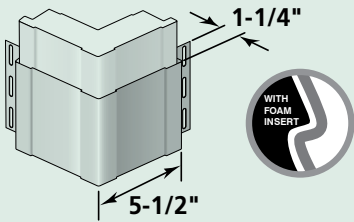

Product Code: 51447

Finish: Matte
 Length: 20'
 Pieces/Ctn: 6
 Lin Ft/Ctn: 120
 Cartons/Pallet: 8
 lbs/Ctn: ≤ 80
 Colors Available:

- GG
- SG
- CYP
- SNB
- DT
- NC
- SW
- LM
- HC
- S
- CW

5" Corner Cap

Decorative Corner Cap that fastens to J-Channel

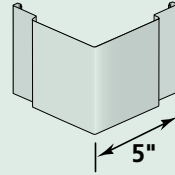

Product Code: 51440

Finish: Matte
 Length: 10'
 Pieces/Ctn: 5
 Lin Ft/Ctn: 50
 Cartons/Pallet: 20
 lbs/Ctn: ≤ 24
 Colors Available:

- SG
- SNB
- DT
- NC
- SW
- LM
- HC
- CW

Fluted SuperCorner™ with foam insert

Fluted corner with foam backing.

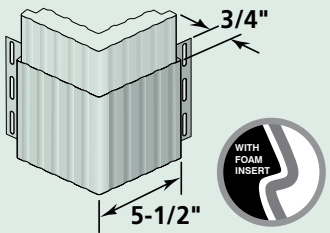

Product Code: 51424

Finish: Matte
 Length: 20'
 Pieces/Ctn: 6
 Lin Ft/Ctn: 120
 Cartons/Pallet: 10
 lbs/Ctn: ≤ 81
 Colors Available:

- S
- CW

Bay Window Cornerpost

Adapts to odd angles of bay windows.

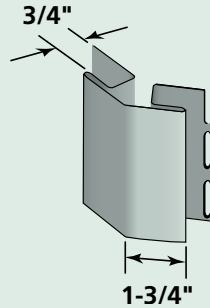

Product Code: 51445

Finish: Matte
 Length: 10'
 Face: 1-3/4"
 Pieces/Ctn: 10
 Lin Ft/Ctn: 100
 Cartons/Pallet: 21
 lbs/Ctn: ≤ 32
 Colors Available:

- AR
- TC
- MC
- SB
- HS
- SDE
- SPR
- F
- IG
- PB
- FS
- CG
- GG
- SG
- BB
- OB
- SEA
- CYP
- GT
- LIN
- SA
- HB
- SNB
- DT
- NC
- SW
- LM
- BS
- SP
- HC
- AY
- S
- CW

Quarter Round Insert

Installed with a universal corner starter and lineals as a decorative corner treatment for use with a 4-piece corner system.



Product Code: 51438

Finish: Matte
 Length: 20'
 Pieces/Ctn: 10
 Lin Ft/Ctn: 200
 Cartons/Pallet: 48
 lbs/Ctn: ≤ 30
 Colors Available:

- NC
- S
- CW

Explore Your Cedar Impressions® Options

CertainTeed provides Vinyl Carpentry® corners, or specially designed Mitered Inside and Mitered Outside cornerposts for Cedar Impressions siding.

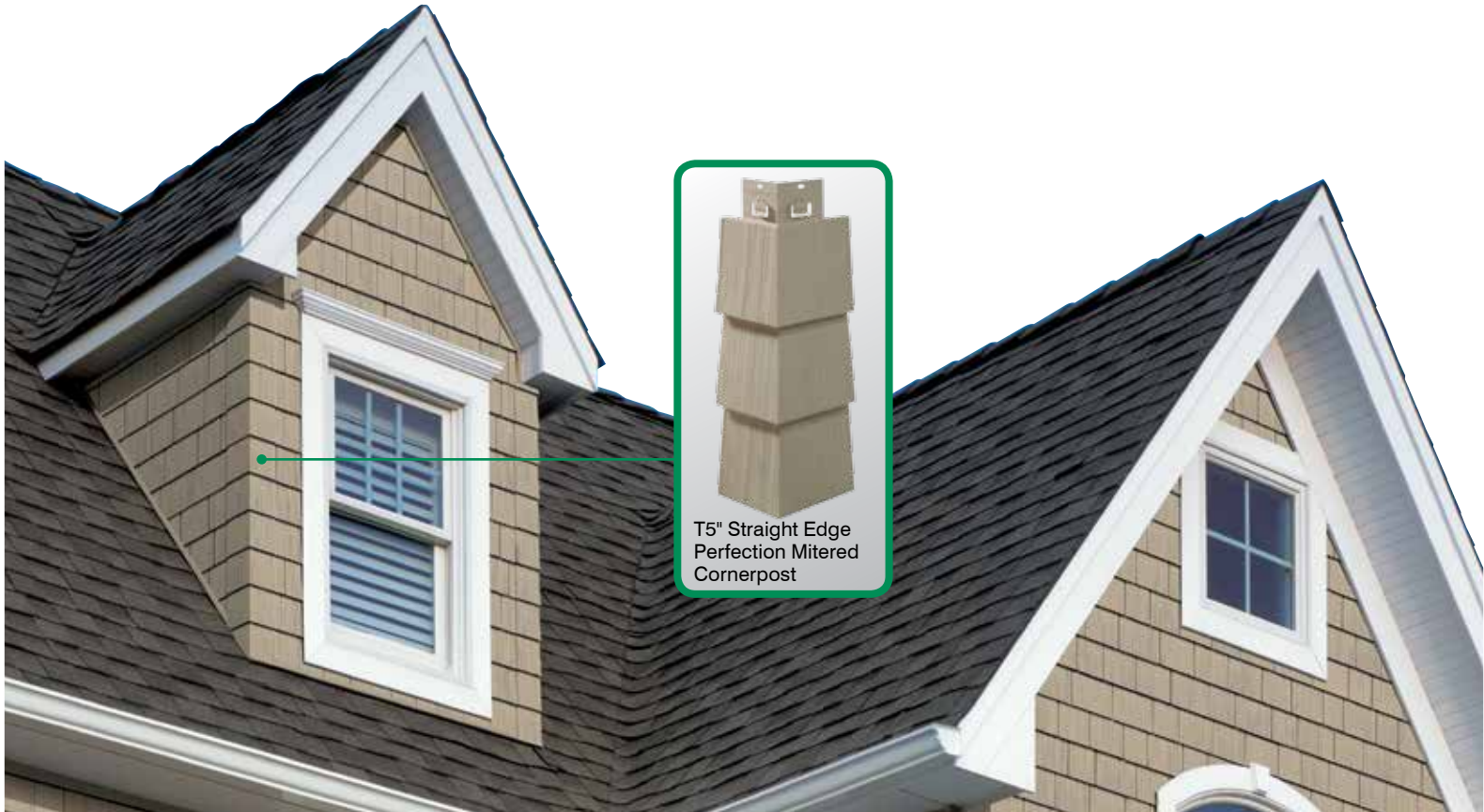



S7\"/>Mitered Bay Window Inside Cornerpost



D7\"/>Straight Edge Perfection Mitered Cornerpost

Corner Systems

Select Your Cedar Impressions® Products

T5" Straight Edge Perfection Mitered Cornerpost

For use with Cedar Impressions T5" Straight Edge Perfection Shingles

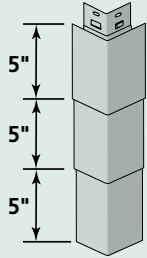

Product Code: 51430

Finish: Cedar Grain
Length: 15"
Pieces/Ctn: 20
Lin Ft/Ctn: 25
Cartons/Pallet: 24
lbs/Ctn: ≤ 15
Colors Available:

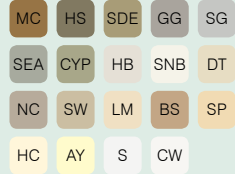

D7" Staggered Perfection Mitered Cornerpost

For use with Cedar Impressions D7" Staggered Perfection Shingles

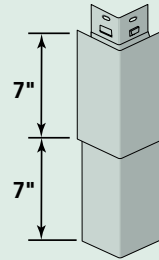

Product Code: 51451

Finish: Cedar Grain
Length: 14"
Pieces/Ctn: 20
Lin Ft/Ctn: 23' 3"
Cartons/Pallet: 32
lbs/Ctn: ≤ 14
Colors Available:



D7" Straight Edge Perfection Mitered Cornerpost

For use with Cedar Impressions D7" Straight Edge Perfection Shingles

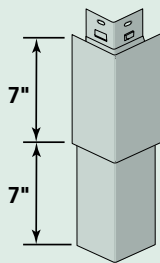

Product Code: 51448

Finish: Cedar Grain
Length: 14"
Pieces/Ctn: 20
Lin Ft/Ctn: 23' 3"
Cartons/Pallet: 32
lbs/Ctn: ≤ 14
Colors Available:



D7" Straight Edge Rough-Split Mitered Cornerpost

For use with Cedar Impressions D7" Straight Edge Rough-Split Shakes

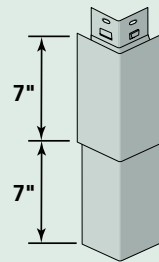

Product Code: 51450

Finish: Cedar Shake
Length: 14"
Pieces/Ctn: 20
Lin Ft/Ctn: 23' 4"
Cartons/Pallet: 24
lbs/Ctn: ≤ 17
Colors Available:



D7" Straight Edge Perfection Mitered Inside Cornerpost

For use with Cedar Impressions D7" Straight Edge Perfection Shingles

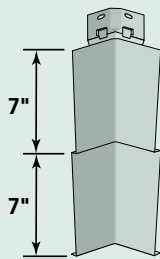

Product Code: 51453

Finish: Cedar Grain
Length: 14"
Pieces/Ctn: 20
Lin Ft/Ctn: 23' 3"
Cartons/Pallet: 32
lbs/Ctn: ≤ 10
Colors Available:



D9" Staggered Rough-Split Mitered Cornerpost

For use with Cedar Impressions D9" Staggered Rough-Split Shakes

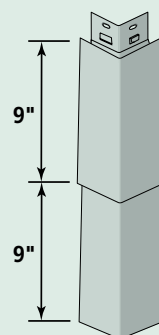

Product Code: 51432

Finish: Cedar Shake
Length: 18-1/2"
Pieces/Ctn: 20
Lin Ft/Ctn: 31
Cartons/Pallet: 18
lbs/Ctn: ≤ 21
Colors Available:



**S7" Mitered Bay Window
Outside Cornerpost**

For use with Cedar Impressions
D7" Straight Edge Perfection
Shingle angles of bay windows

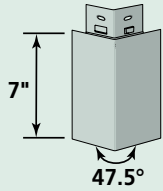

Product Code: 51454

Finish: Cedar Grain
Length: 7"
Pieces/Ctn: 20
Lin Ft/Ctn: 11' 8"
Cartons/Pallet: 75
lbs/Ctn: ≤ 6
Colors Available:



**S7" Mitered Bay Window
Inside Cornerpost**

For use with Cedar Impressions
D7" Straight Edge Perfection
Shingle angles of bay windows

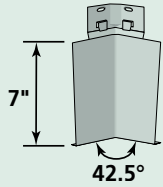

Product Code: 51455

Finish: Cedar Grain
Length: 7"
Pieces/Ctn: 20
Lin Ft/Ctn: 11' 8"
Cartons/Pallet: 75
lbs/Ctn: ≤ 5
Colors Available:



Cedar Impressions D7" Straight Edge Perfection Shingles



Board & Batten



Cedar Impressions D9" Staggered Rough-Split Shakes



D7" Straight Edge Rough-Split Shakes



Cedar Impressions D6-1/4" Half-Round Shingles and D7" Straight Edge Rough-Split Shakes



When it comes to adding a personal touch to your home's exterior, accents bring out the best in any style of house. Grab attention with subtle or exciting color combinations. Add charm with Board & Batten. Or create a custom-crafted wood look with beautifully textured, Cedar Impressions® shingles and shakes. CertainTeed makes it easy to create a masterpiece you'll enjoy for years to come.

Explore Your Options

CertainTeed's complete selection of exterior product options is tailor-made to take advantage of the exciting mix-and-match trend: combining various materials, textures, styles and colors to create truly unique exterior designs.

With multiple profiles of Cedar Impressions®, Board & Batten and Vertical Siding to choose from, the possible ways to accent your home are endless.

Fast fact:

Are shingles and shakes the same thing?

Usually, a shingle is sawn on both sides and is thinner at the butt than a shake. A shake is typically split on one or both sides. Shakes are generally thicker with more aggressive, rougher texture that is far less precise than that of a shingle.



D7" Straight Edge
Rough-Split Shakes

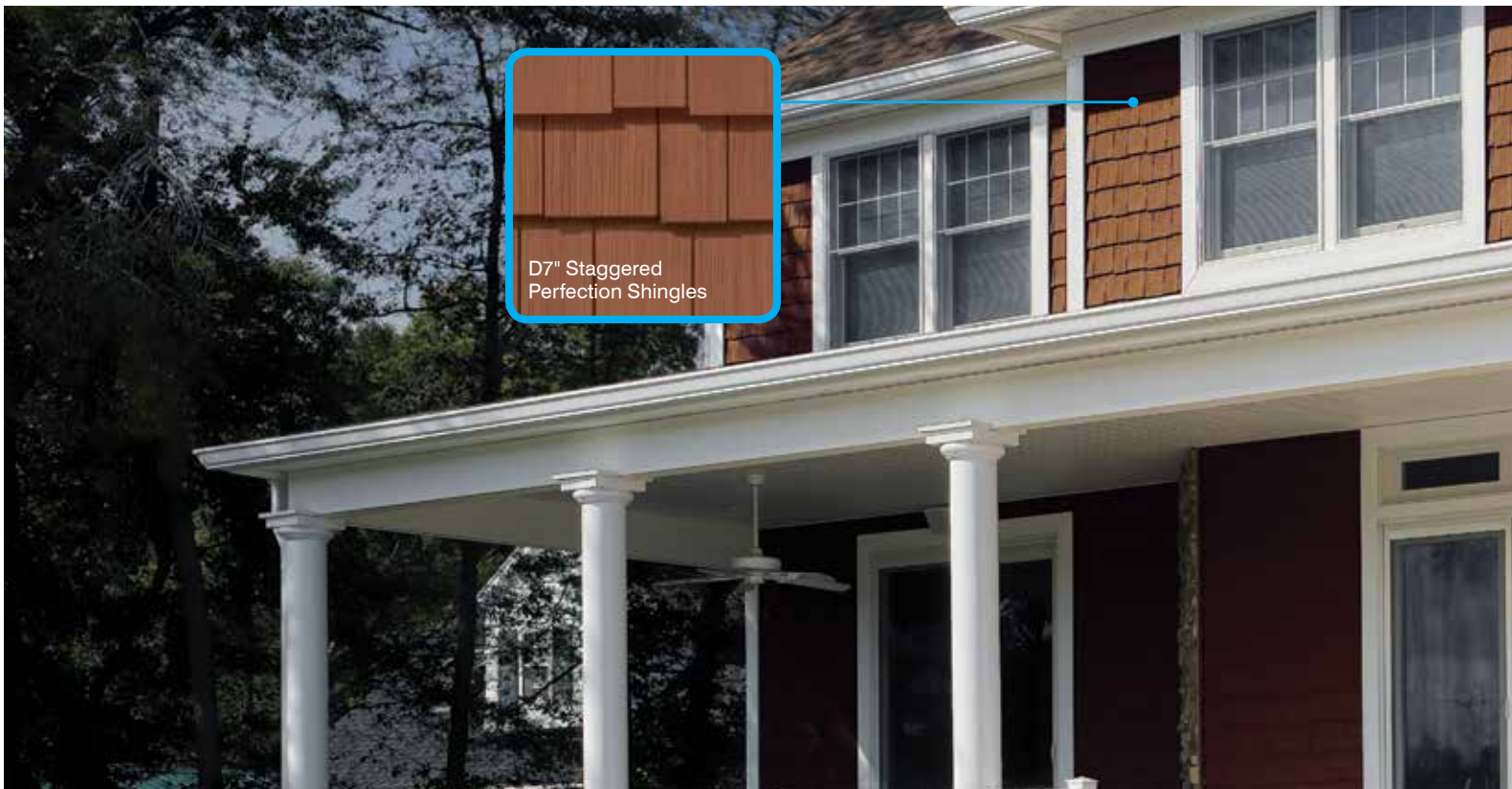

D7" Staggered
Perfection Shingles

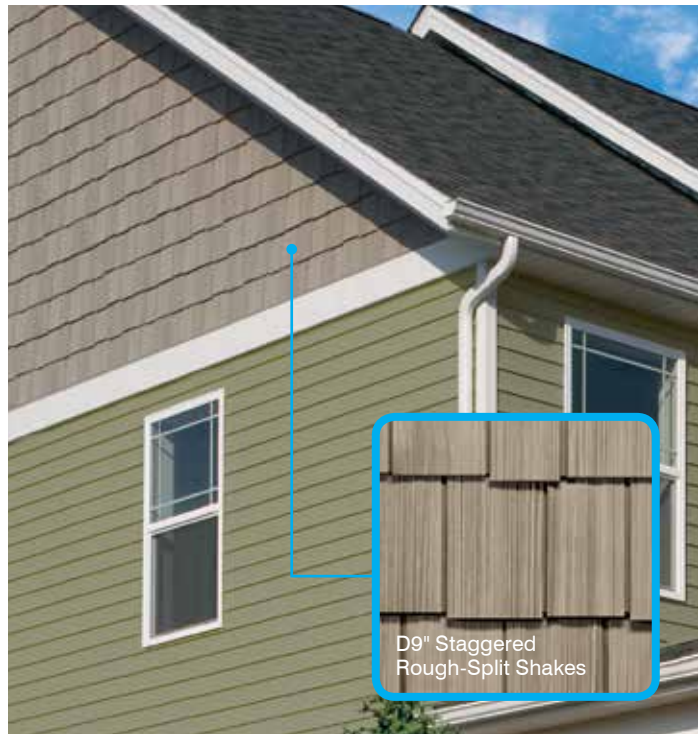
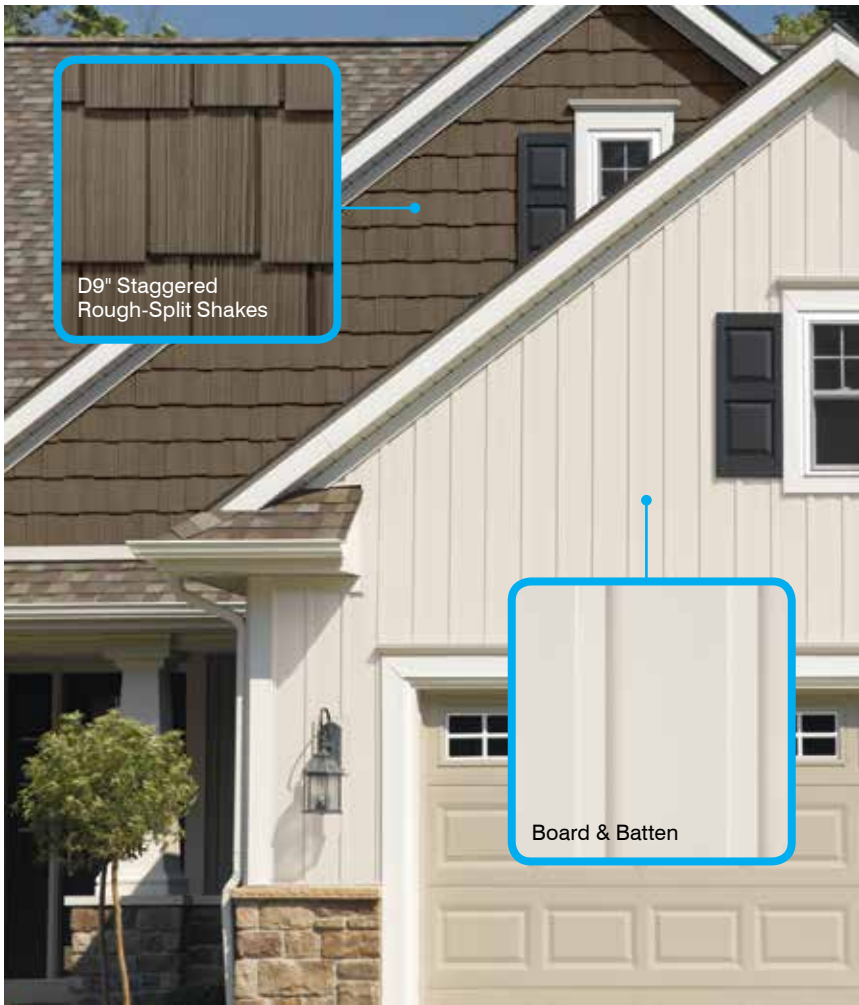

Accents

Select Your Products

Cedar Impressions® Triple 5" Straight Edge Perfection Shingles

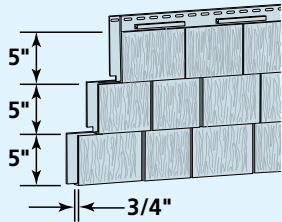

Product Code: 30130

Finish: Cedar Grain
Length: 60"
Thickness: .100"
Exposure: 15"
Projection: 3/4"
Panels/Ctn: 8
Squares/Ctn: .50
Cartons/Pallet: 20
lbs/Ctn: ≤ 43
Colors Available:

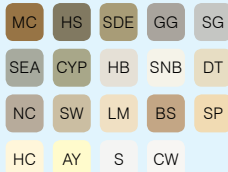

Cedar Impressions® Double 7" Staggered Perfection Shingles

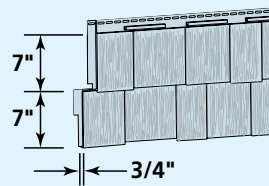

Product Code: 30143

Finish: Cedar Grain
Length: 48"
Thickness: .100"
Exposure: 14"
Projection: 3/4"
Panels/Ctn: 11
Squares/Ctn: .50
Cartons/Pallet: 16
lbs/Ctn: ≤ 44
Colors Available:



Cedar Impressions® Double 7" Straight Edge Perfection Shingles

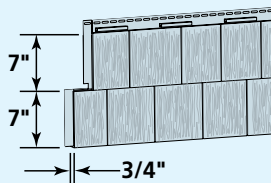

Product Code: 30138

Finish: Cedar Grain
Length: 48"
Thickness: .100"
Exposure: 14"
Projection: 3/4"
Panels/Ctn: 11
Squares/Ctn: .50
Cartons/Pallet: 16
lbs/Ctn: ≤ 42
Colors Available:



Cedar Impressions® Double 7" Straight Edge Rough-Split Shakes

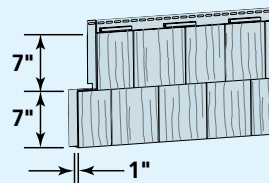

Product Code: 30141

Finish: Cedar Shake
Length: 57"
Thickness: .125"
Exposure: 14"
Projection: 1"
Panels/Ctn: 9
Squares/Ctn: .50
Cartons/Pallet: 16
lbs/Ctn: ≤ 47
Colors Available:



**Cedar Impressions®
Double 9" Staggered
Rough-Split Shakes'**

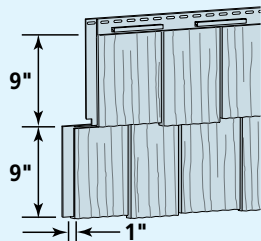

Product Code: 30136

Finish: Cedar Shake
Length: 57"
Thickness: .125"
Exposure: 18"
Projection: 1"
Panels/Ctn: 7
Squares/Ctn: .50
Cartons/Pallet: 16
lbs/Ctn: ≤ 50

Colors Available:



**Cedar Impressions® Double
6-1/4" Half-Round Shingles**

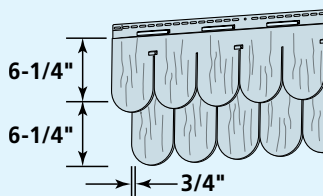

Product Code: 30128

Finish: Cedar Grain
Length: 32"
Thickness: .100"
Exposure: 12-1/2"
Projection: 3/4"
Panels/Ctn: 12
Squares/Ctn: .333
Cartons/Pallet: 16
lbs/Ctn: ≤ 27

Colors Available:



**Single 12" Insulated Vertical
Board & Batten - 10'**

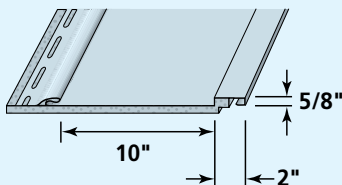

Product Code: 58153

Finish: Rough Cedar
Length: 10'
Thickness: .052"
Exposure: 12"
Projection: 1- 1/4" complete assembly
Panels/Ctn: 10
Squares/Ctn: 1
Cartons/Pallet: 9
lbs/Ctn: ≤ 59

Colors Available:



**Single 8" Vertical
Board & Batten - 10'**

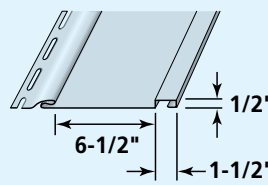

Product Code: 34138

Finish: Rough Cedar
Length: 10'
Thickness: .048"
Exposure: 8"
Projection: 1/2"
Panels/Ctn: 15
Squares/Ctn: 1
Cartons/Pallet: 24
lbs/Ctn: ≤ 55

Colors Available:



**Single 8" Vertical
Board & Batten - 12' 6"**

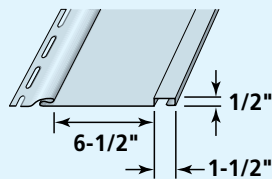

Product Code: 34137

Finish: Rough Cedar
Length: 12' 6"
Thickness: .048"
Exposure: 8"
Projection: 1/2"
Panels/Ctn: 12
Squares/Ctn: 1
Cartons/Pallet: 28
lbs/Ctn: ≤ 57

Colors Available:



**Chamfer Board™
Double 5" Solid Vertical**

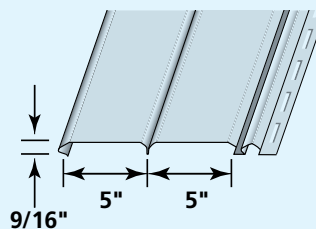

Code: 32100

Finish: Brushed
Length: 12'
Thickness: .044"
Exposure: 10"
Projection: 9/16"
Panels/Ctn: 20
Squares/Ctn: 2
Cartons/Pallet: 14
lbs/Ctn: ≤ 77

Colors Available:

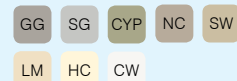

5" Double Channel Lineal



Band Board



Cornice Molding





Wall & Soffit Transitions

Band Board



Attractive transitions between styles, architectural elements and colors are the best way to ensure a uniform design on any home. CertainTeed offers a wide variety of wall and soffit transition options for you to create beautiful transitions, while providing protection from damaging moisture.

Explore Your Options

Trim provides a beautiful transition between two styles of siding. On long expanses of board & batten or soffit, a trim piece offers a way to add a signature outline or focal point. Also, consider a trim piece to transition from the wall up to the soffit.

Fast fact:

Band [Belly] Board:
Typically 5"- 6" reveal, can be used as a starter course for siding, a frieze board, a bold line separating levels of a house, or a transition piece in installations where siding alternates between horizontal, vertical and/or specialty profiles.
(Source: Vinyl Siding Institute)

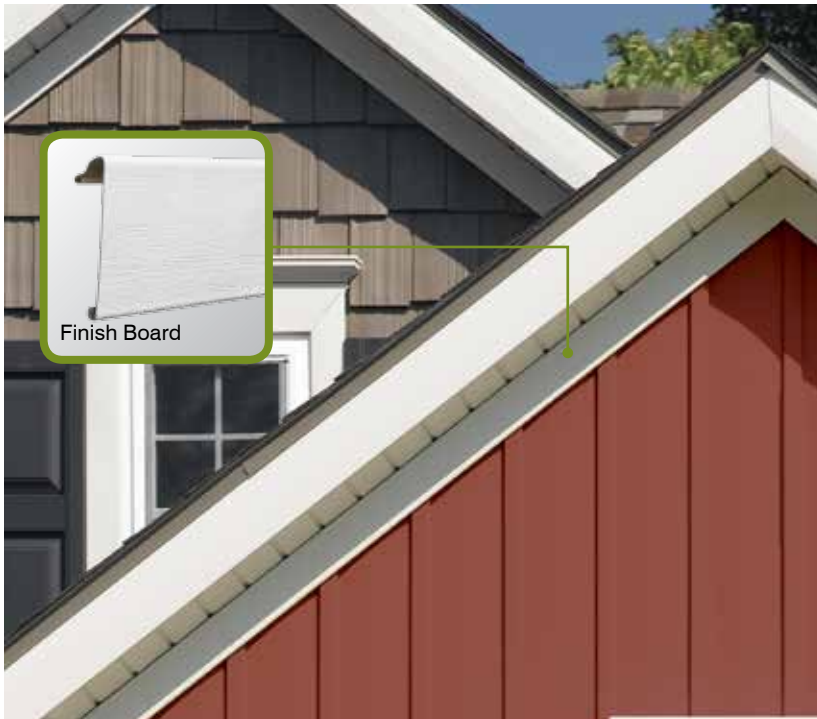



Create a transition using a band board with foam insert, or create your transition using a wide-faced lineal.

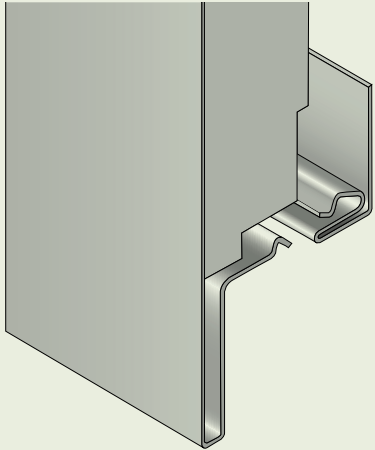

A **band board** makes an excellent wall transition.

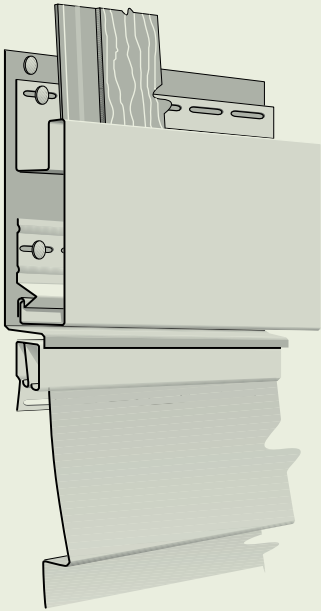

Lineals can transition lap siding to Cedar Impressions.



Select Your Products

Cornice Molding

Held in place by the Deluxe F-Channel or L-Receiver, this accessory hides the installation of the topmost siding panels.

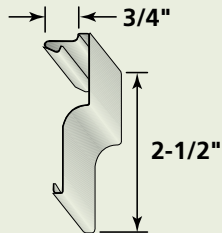

Product Code: 55817

Finish: Matte
 Length: 12' 6"
 Pieces/Ctn: 10
 Lin Ft/Ctn: 125
 Cartons/Pallet: 64
 lbs/Ctn: ≤ 16
 Colors Available:



Cornice Molding Cornerpost Cap

Used to cap Cornice Molding over Mitered Cornerposts.

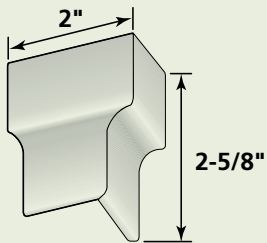

Product Code: 55808

Finish: Matte
 Pieces/Ctn: 20
 Cartons/Pallet: 120
 lbs/Ctn: ≤ 1
 Colors Available:



Cornice Receiver

Installed under the eaves to hold the Cornice Molding. Also receives Band Board and Finish Board.

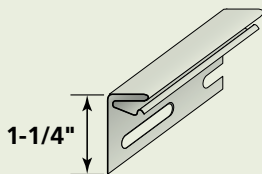

Product Code: 55812

Finish: Matte
 Length: 12' 6"
 Pieces/Ctn: 24
 Lin Ft/Ctn: 300
 Cartons/Pallet: 35
 lbs/Ctn: ≤ 28
 No Color

Finish Board

A 3-1/2" top molding piece with a 1-1/4" projection designed for use with CedarBoards Insulated Siding.

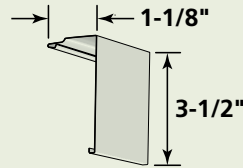

Product Code: 55815

Finish: Rough Cedar
 Length: 12' 6"
 Pieces/Ctn: 10
 Lin Ft/Ctn: 125
 Cartons/Pallet: 49
 lbs/Ctn: ≤ 19
 Colors Available:



Deluxe F-Channel

Installed under eaves to hold Cornice Molding in place. Also receives soffit panels.

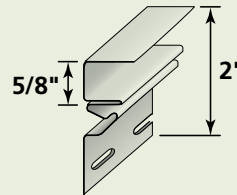

Product Code: 52503

Finish: Matte
 Length: 12' 6"
 Channel: 5/8"
 Pieces/Ctn: 24
 Lin Ft/Ctn: 300
 Cartons/Pallet: 32
 lbs/Ctn: ≤ 39
 Colors Available:



F-Channel

Receives soffit panels and helps hold 8" vinyl fascia in place. Available in 3/4" (52506) and 5/8" (52502)

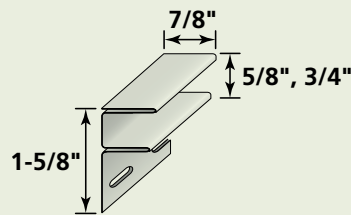

Finish: Matte
 Length: 12' 6"
 Pieces/Ctn: 24
 Lin Ft/Ctn: 300
 Cartons/Pallet: 35
 Colors Available:
 see page 36



Band Board with foam insert

A 7-1/4" wide insulated lineal that serves as a transition piece between two different styles of siding or other construction materials.

Note: Use the dual-undersill trim (56916) to accommodate the lap siding below.

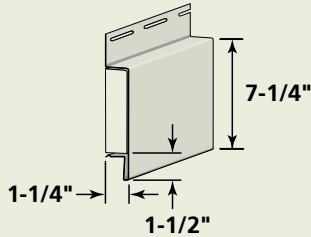

Product Code: 55814

Finish: Rough Cedar
Length: 16' 8"
Pieces/Ctn: 5
Lin Ft/Ctn: 82' 5"
Cartons/Pallet: 16
lbs/Ctn: ≤ 33
Colors Available:

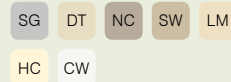

5" Double Channel Lineal

Exposure matches 5" window and door surround lineals.

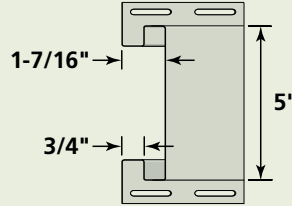

Product Code: 54714

Finish: Matte
Length: 18'
Pieces/Ctn: 10
Lin Ft/Ctn: 180
Cartons/Pallet: 15
lbs/Ctn: ≤ 66
Colors Available:



Soffit Cove Trim

A decorative soffit receiver.

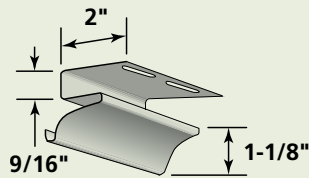

Product Code: 52501

Finish: Matte
Length: 12' 6"
Channel: 1/2"
Pieces/Ctn: 24
Lin Ft/Ctn: 300
Cartons/Pallet: 24
lbs/Ctn: ≤ 49
Colors Available:



1/2" H-Bar

Joins soffit panels. Particularly useful on porch ceilings and hip roof applications.

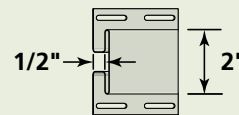

Product Code: 52504

Finish: Matte
Length: 12' 6"
Channel: 1/2"
Pieces/Ctn: 10
Lin Ft/Ctn: 125
Cartons/Pallet: 39
lbs/Ctn: ≤ 29
Colors Available:



3-1/2" Double Channel Lineal

Exposure matches 3-1/2" window and door surround lineals.

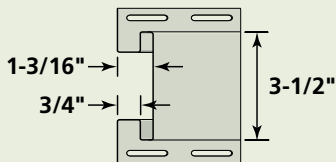

Product Code: 54713

Finish: Matte
Length: 18'
Pieces/Ctn: 10
Lin Ft/Ctn: 180
Cartons/Pallet: 30
lbs/Ctn: ≤ 55
Colors Available:



3/8" H-Bar

Joins soffit panels. Particularly useful on porch ceilings and hip roof applications.

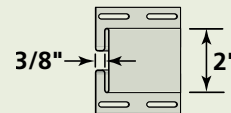

Product Code: 52505

Finish: Matte
Length: 12' 6"
Channel: 3/8"
Pieces/Ctn: 10
Lin Ft/Ctn: 125
Cartons/Pallet: 53
lbs/Ctn: ≤ 28
Colors Available:



3/4" H-Bar

Joins soffit panels. Particularly useful on porch ceilings and hip roof applications.

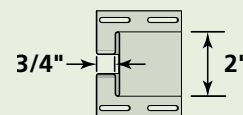

Product Code: 52507

Finish: Matte
Length: 12' 6"
Channel: 3/4"
Pieces/Ctn: 10
Lin Ft/Ctn: 125
Cartons/Pallet: 42
lbs/Ctn: ≤ 32
Colors Available:

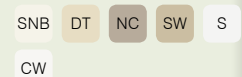

Look what you can achieve with color:



Find Your Perfect Color Mix

Designers are using every conceivable color combination to create distinctive exterior designs with a modern sensibility. You can do the same thing with your home. The optimum color blend has the power to bring out the best features of your home. Whatever your color goal is, CertainTeed can help you reach it.



This home has a cool theme (selection of cool grays), but it also has a subtle theme because these grays have similar color intensity and value.

Trim Color Combinations

Traditional white trim accentuates windows cleanly with any color siding, as shown below. Other options (left) include a more subtle combination, with trim and siding closer in hue and intensity; or a reversal of dark trim with light siding as a powerful way to frame your home.



This home has a warm theme with a cool accent (green), and the colors are stronger than a typical home.



CertainTeed Color Tools

Explore the possibilities



ColorView® offers users the ability to mix and match colors and styles on a wide variety of pre-populated home styles to get design ideas.

ColorView® DIY lets users who are short on time begin designing today – upload a picture of your home and in just a few minutes you can mix and match colors and styles on your own home.

ColorView® Pro gives users the opportunity to have a photo of their home professionally masked in just a few days for them to use in ColorView Online.

Visit the color tools page:
www.certainteed.com/colorview

What is Your Color Comfort?

Our user-friendly color tools are designed to help you every step of the way. This chart shows which tool will work best for your color comfort level.

Novice

You are not sure about colors and where to start.

Intermediate

You understand color and enjoy experimenting with color combinations but are not exactly sure which color direction you want to go.

Expert

You already know what colors you want to use, but would like to see how the products available in your color theme will look together on your home.

	ColorCoach	CertainTeed CurbAppeal	ColorView	ColorView DIY	ColorView Pro
Novice You are not sure about colors and where to start.	X	X			
Intermediate You understand color and enjoy experimenting with color combinations but are not exactly sure which color direction you want to go.		X	X		
Expert You already know what colors you want to use, but would like to see how the products available in your color theme will look together on your home.				X	X



CurbAppeal®

Make product selection a breeze with CertainTeed's new CurbAppeal app for the iPad®. Review and select colors, styles, textures for all of our siding, decking, railing and fence products, or browse our gallery of homes for ideas that inspire.

ColorCoach™

A simple web-based tool that acts as a virtual color swatch book. You can save different combinations, use them in ColorView and share them via social media for second opinions.



Trim-It

CertainTeed's "Trim-It" tool allows you to create distinction with the wide offering of accent and decorative trim products from both the vinyl and composite product lines.



CertainTeed products are designed to work together and complement each other in color and style to give your home a beautiful finished look.



Polymer Shakes & Shingles



Roofing and Ventilation



Fence



Insulated Siding



PVC Exterior Trim & Beadboard



Decking and Railing



Vinyl Siding



Vinyl Carpentry® Trim



Housewrap



Professional: [facebook.com/CertainTeedFreedomofChoice](https://www.facebook.com/CertainTeedFreedomofChoice)
Consumer: [facebook.com/CertainTeedLivingSpaces](https://www.facebook.com/CertainTeedLivingSpaces)

[**Be Certain**] Confidence worth building on.™

ASK ABOUT OUR OTHER CERTAINTEED® PRODUCTS AND SYSTEMS:

ROOFING • SIDING • TRIM • DECKING • RAILING • FENCE
 GYPSUM • CEILINGS • INSULATION

www.certainteed.com <http://blog.certainteed.com>

CertainTeed Corporation
 P.O. Box 860
 Valley Forge, PA 19482

Professional: 800-233-8990
Consumer: 800-782-8777

© 1/15 CertainTeed Corporation, Printed in U.S.A.
 Code No. CTS160



CertainTeed

RESTORATION CLASSIC™

Siding

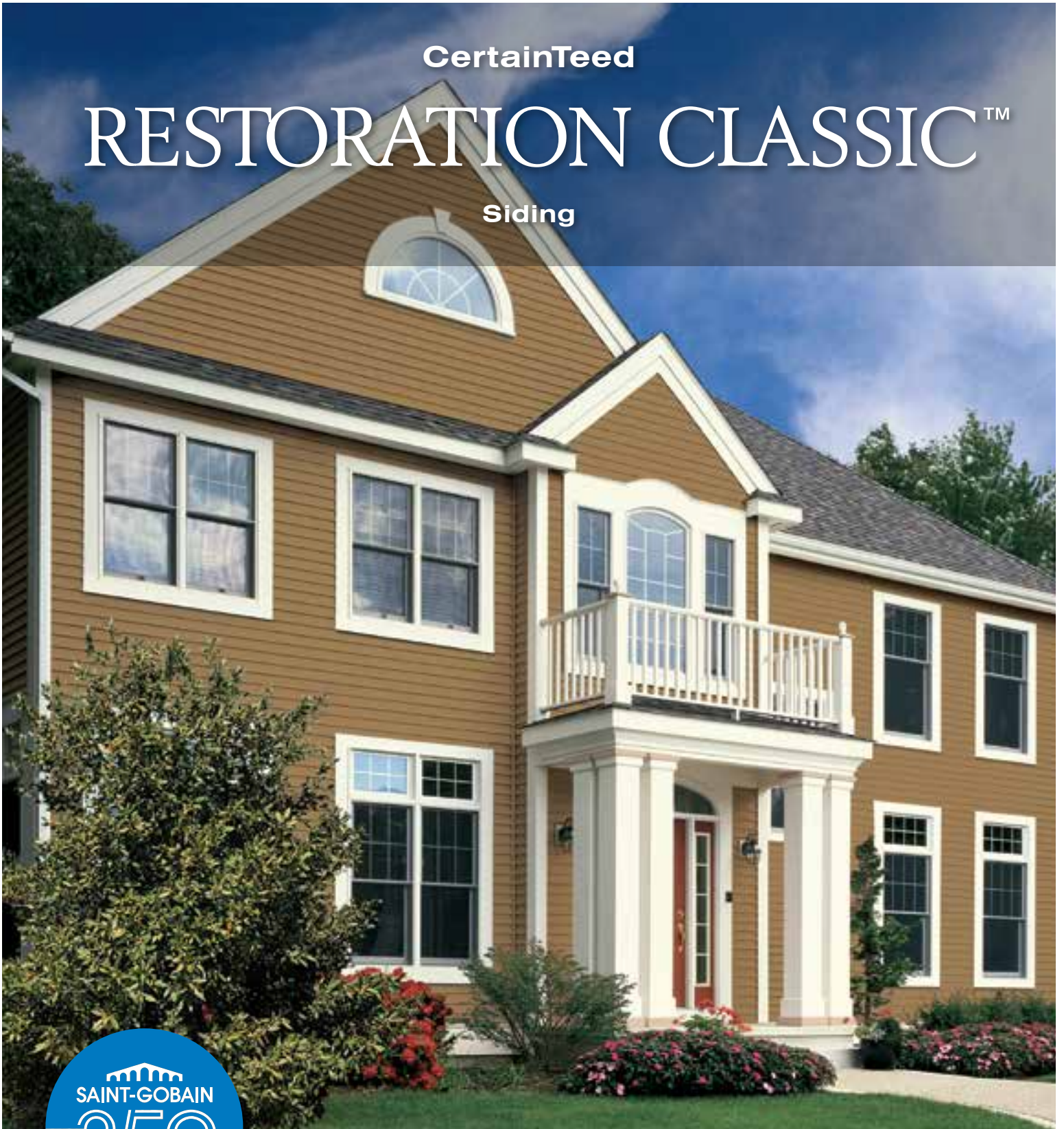

1665 – 2015

CertainTeed
SAINT-GOBAIN

**ARCHITECTURAL ACCURACY
AND BEAUTY, PERFORMANCE
AND DURABILITY**



RESTORATION CLASSIC™

Restoration Classic™ provides the premium features that make it a great choice for both remodeling and new construction.



◀ Front Cover

Siding: Restoration Classic Double 4" Select Cedar Clapboard in mountain cedar.

Trim: Vinyl Carpentry® & Restoration Millwork®.

◀ Shown Here

Siding: Restoration Classic Triple 3" Smooth Clapboard in heritage cream.

Trim: Vinyl Carpentry® & Restoration Millwork®.

FEATURES



RigidForm™ Technology

RigidForm 180 (rolled-over nail hem) technology stiffens siding for a straighter-on-the-wall appearance and has been tested* to withstand wind load pressures up to 180 mph.

* Wind load rating per VSI wind speed calculation guidelines.



DuraLock® features an oversized rigid tear-drop shape which is substantially larger than many competitors' locks, providing secure installation.

Available in Two Finishes

Double 4" Clapboard, Double 5" Clapboard and Double 4-1/2" Dutchlap are available in Select Cedar finish, which has a natural woodgrain appearance. Double 4-1/2" and Triple 3" Clapboard have a Smooth low-gloss finish which replicates sanded, sealed and painted wood.



Double 4"
Select Cedar
Clapboard
in terra cotta

Double 4-1/2"
Select Cedar
Dutchlap
in charcoal gray

The STUDfinder™ Installation System

STUDfinder combines precisely spaced nail slots with indicator letters, designed for accurate and secure installation.



STUDfinder for Accuracy

- Nail slots align with 16" on-center standards for stud spacing.
- Indicator letters help:
 - Determine location of studs
 - Ensure nails are positioned correctly
 - Ensure correct number of nails are used

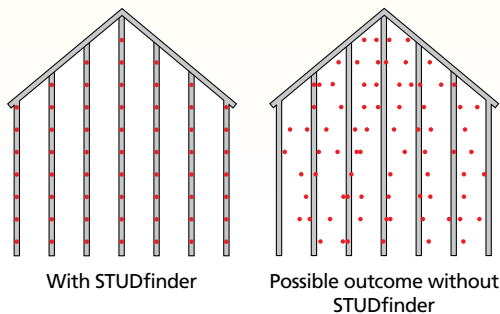

STUDfinder for Security and Performance

- Nailing to studs provides a strong and secure connection.
- Protects against blow offs from under nailing.
- Protects against buckling from over nailing.
- Helps avoid nailing into hazardous items between studs like plumbing or wiring.

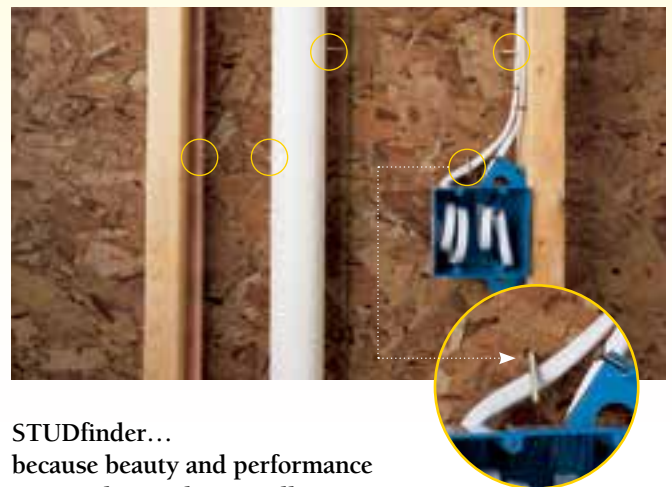

STUDfinder...
because beauty and performance
start with a quality installation.

16"



FAST FACTS	
STYLES & FINISHES	Double 4" Select Cedar Clapboard Double 4-1/2" Select Cedar Dutchlap Double 5" Select Cedar Clapboard Double 4-1/2" Smooth Clapboard Triple 3" Smooth Clapboard
LOW GLOSS COLORS	28 Low-Gloss Colors with Coordinating Trim Colors
THICKNESS	.044" Nominal
NAIL HEM AND LOCK	STUDfinder™ Installation System DuraLock® Post-Formed Lock
PANEL PROJECTION	5/8"
FIRE RATING	Class 1(A)
WARRANTY	Lifetime Limited with PermaColor™ Lifetime Fade Protection

Double 5" Select Cedar Clapboard in heritage cream

Double 4-1/2" Smooth Clapboard in natural clay

Triple 3" Smooth Clapboard in cypress



Color performance, impact resistance and durability are assured through our exclusive PermaColor™ System, a blend of our own Certavin™ resin, superior micro-ingredients and state-of-the-art pigment chemistry.

	Double 4" Clapboard, Select Cedar	Double 4-1/2" Dutchlap, Select Cedar	Double 5" Clapboard, Select Cedar	Double 4-1/2" Clapboard, Smooth	Triple 3" Clapboard, Smooth
* Autumn Red	●	●			
* Terra Cotta	●				
* Mountain Cedar	●				
* Sable Brown	●				
* Hearthstone	●				
Suede	●	●			
* Spruce	●				
* Forest	●	●			
* Pacific Blue	●				
* Flagstone	●				
* Charcoal Gray	●	●			
Granite Gray	●	●	●	●	●
Sterling Gray	●	●	●	●	●
Oxford Blue	●	●	●	●	●
Seagrass	●	●	●		
Cypress	●	●	●	●	●
Linen	●	●	●		
Herringbone	●	●	●	●	●
Sandstone Beige	●	●	●	●	●
Desert Tan	●	●	●	●	●
Natural Clay	●	●	●	●	●
Savannah Wicker	●	●	●	●	●
Light Maple	●	●	●	●	●
Buckskin	●	●			
Heritage Cream	●	●	●	●	●
Autumn Yellow	●	●	●		
Snow	●	●	●	●	●
Colonial White	●	●	●	●	●



Siding: Restoration Classic Double 5" Select Cedar Clapboard in linen.
Soffit: Beaded Vinyl Soffit in colonial white.
Trim: Vinyl Carpentry® and Restoration Millwork®.



Start exploring preset color combinations and create your own custom exterior with on-line, interactive tools, designed to help you "Visualize Your Home".
Start now at certainteed.com/colortools

NOTE: Colors throughout this brochure are simulated. Consult product samples before making final selection.

* DELUXE COLORS



CertainTeed products are designed to work together and complement each other in color and style to give your home a beautiful finished look.



Polymer Shakes & Shingles



Roofing and Ventilation



Fence



Insulated Siding



PVC Exterior Trim & Beadboard



Decking and Railing



Vinyl Siding



Vinyl Carpentry® Trim



Housewrap



Professional: [facebook.com/CertainTeedFreedomofChoice](https://www.facebook.com/CertainTeedFreedomofChoice)
Consumer: [facebook.com/CertainTeedLivingSpaces](https://www.facebook.com/CertainTeedLivingSpaces)

[**Be Certain**] Confidence worth building on.™

ASK ABOUT OUR OTHER CERTAINTEED® PRODUCTS AND SYSTEMS:

ROOFING • SIDING • TRIM • DECKING • RAILING • FENCE
 GYPSUM • CEILINGS • INSULATION

www.certainteed.com <http://blog.certainteed.com>

CertainTeed Corporation
 P.O. Box 860
 Valley Forge, PA 19482

Professional: 800-233-8990
Consumer: 800-782-8777

© 1/15 CertainTeed Corporation, Printed in U.S.A.
 Code No. CTS448



CertainTeed

Finishing Touches

Vinyl Carpentry® • Restoration Millwork®

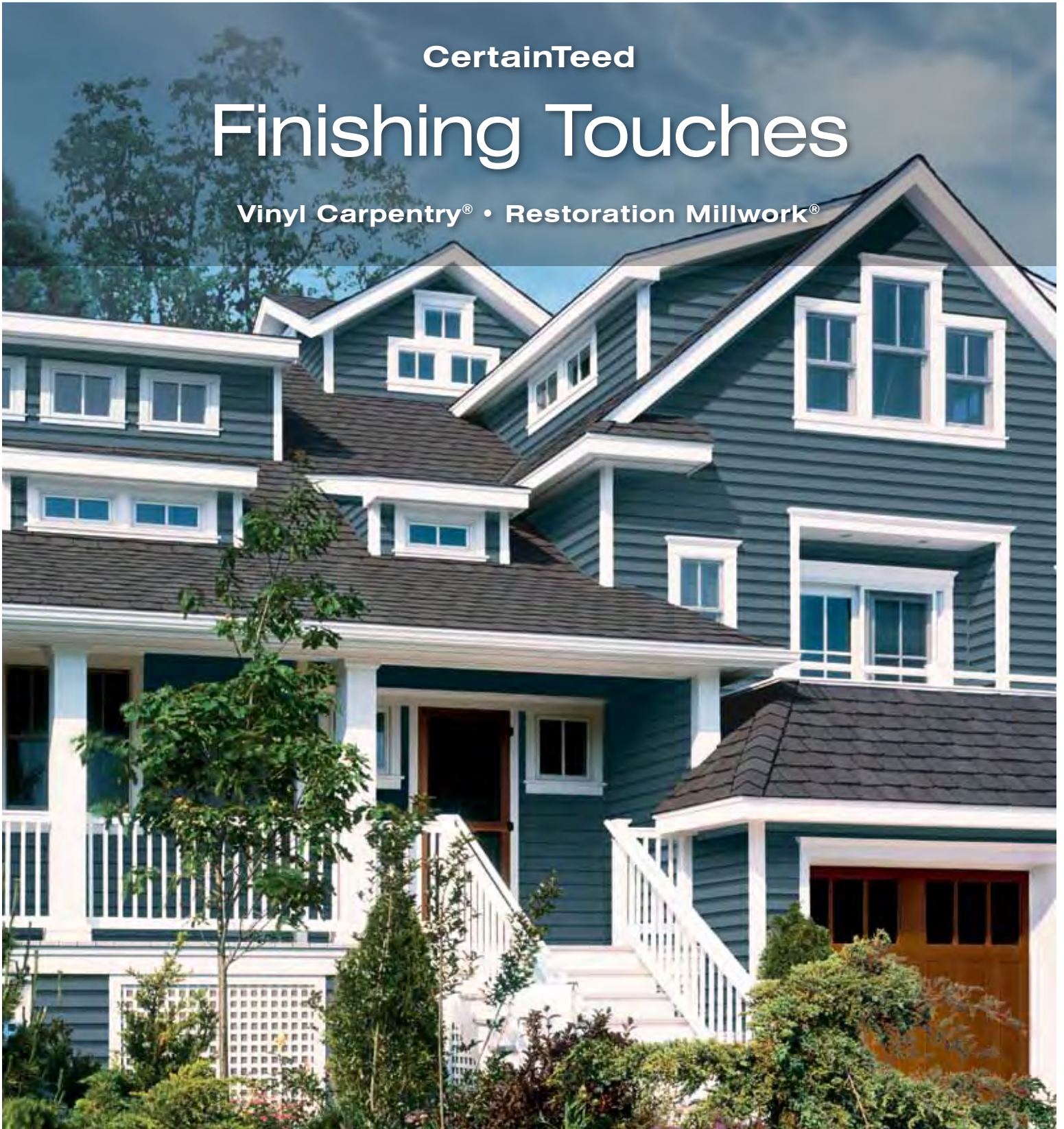

CertainTeed
SAINT-GOBAIN



Restoration Millwork sheets and trimboards combined with bed mould and base cap profiles.

Details Create The Personality.

New siding makes any house look better. But it's the unique details that truly reflect your personality. CertainTeed offers a complete selection of virtually maintenance-free exterior, accent and decorative trim products, in styles and colors designed to work seamlessly with CertainTeed's wide range of siding options.



Vinyl Carpentry Band Board transition from lap siding to gable accent.



Cedar Impressions Mitered Corner in heritage cream.



Federal Corner fabricated using 3-1/2" lineals in Colonial White.



Fluted SuperCorner in colonial white.



Beaded panel and Soffit Cove Trim in colonial white.



Crown Molding and 3-1/2" Lineals used to miter cut corners

Subtle

Basic trim and soft tones offer a design scheme that unifies the look of your home.



Certa-Snap® Wrap
Post Wrap System



3-1/2" Cornerpost

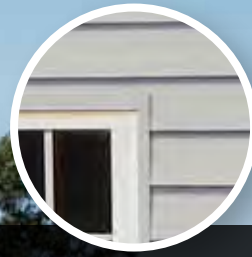

J-Channel

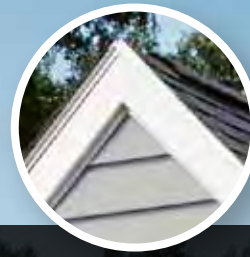

J-Channel with
Aluminum Rake



Siding: CedarBoards™ Single 7" in sterling gray.
Trim: Vinyl Carpentry® in white and sterling gray.
Roofing: Landmark™ Shingles in georgetown gray.



Siding in savannah wicker.



Siding in sandstone beige.

Bold

Strong trim lines with offsetting colors present distinct borders that highlight the architectural textures of your home.



Restoration Millwork®
trimboard*



Restoration Millwork
trimboard*



Vinyl Carpentry®
Cornice Molding with
Aluminum Rake

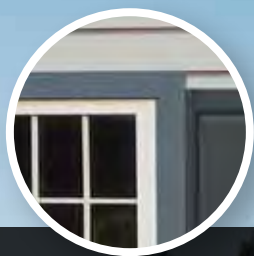

3-1/2" Lineal
with miter cut
corners

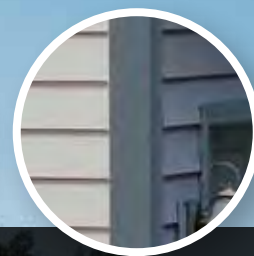

3-1/2" Cornerpost



Siding: CedarBoards Single 7" and
Cedar Impressions Double
7" Straight-Edge Perfection
Shingles in sterling gray.

Trim: Vinyl Carpentry & Restoration
Millwork in pacific blue.

Roofing: Landmark Shingles in
georgetown gray.



Siding in desert tan.
Trim in natural clay.



Siding in savannah wicker.
Trim in ivy green.

*Restoration Millwork painted with Sherwin-Williams ColorSafe Paint.

Contrasting

Definitive color differences on the various shapes and lines of your home convey eye-catching curb appeal.



Panorama®
capped composite
railing system with
Colonial balusters.



Restoration Millwork
Classic Column Wraps



Cedar Impressions
Perfection Mitered
Cornerpost

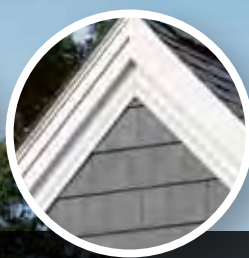

Vinyl Carpentry
Cornice Molding and
Restoration Millwork
Rake Profile

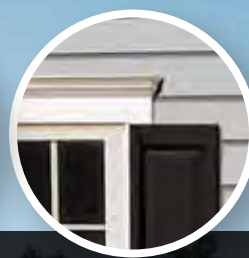

Restoration Millwork
Trimboard with
Rams Crown



Restoration Millwork
One-Piece Corner
with InvisiGrip Hidden
Fastening System



Siding: CedarBoards Single 7" in sterling gray and Cedar Impressions Double 7" Straight Edge Perfection Shingles in charcoal gray.

Trim: Vinyl Carpentry & Restoration Millwork in colonial white.

Roofing: Landmark Shingles in georgetown gray.



Siding in hearstone and savannah wicker.
Trim in colonial white.



Siding in sable brown and timber blend.
Trim in colonial white.

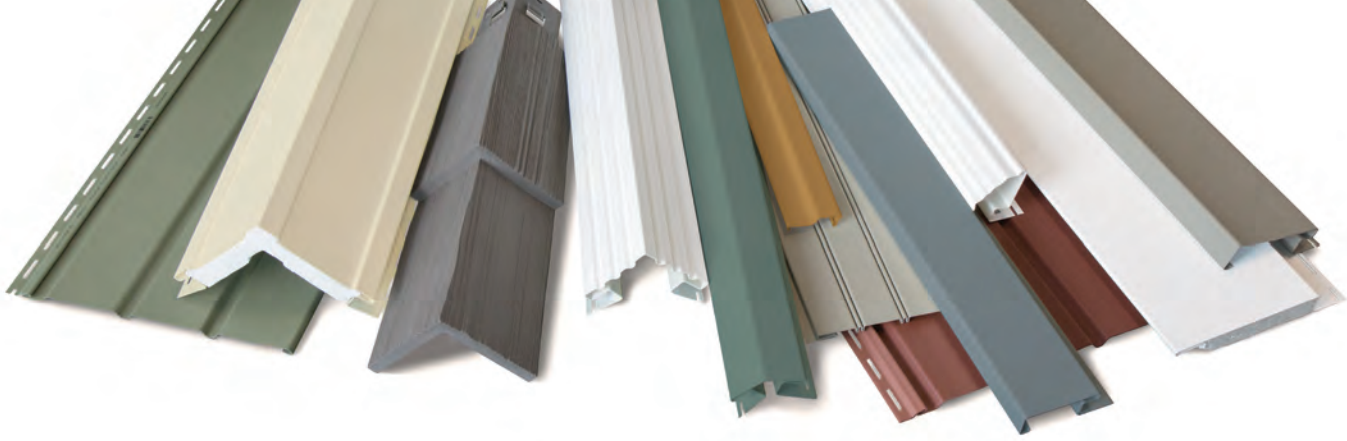

Find Your Perfect Color Mix

Designers are using every conceivable color combination to create distinctive exterior designs with a modern sensibility. You can do the same thing with your home. The optimum color blend has the power to bring out the best features of your home. Whatever your color goal is, CertainTeed can help you reach it.



ColorCoach™

A simple web-based tool that acts as a virtual color swatch book. You can save different combinations, use them in ColorView™ and share them via social media for second opinions.



Available on the App Store

CertainTeed CurbAppeal™

Make product selection a breeze with CertainTeed's new CurbAppeal app for the iPad®. Review and select colors, styles, textures for all of our roofing, siding, decking, railing and fence products, or browse our gallery of homes for ideas that inspire.

CertainTeed Color Tools

CertainTeed has created a number of user-friendly visualization tools to help you get a better idea of how well different colors and styles work together.



ColorView® offers users the ability to mix and match colors and styles on a wide variety of pre-populated home styles to get design ideas.

ColorView DIY lets users who are short on time begin designing today – upload a project picture and in just a few minutes you can mix and match colors and styles on your own project.

ColorView Pro gives users the opportunity to have a photo of their home professionally masked in just a few days for them to use in ColorView Online.

Explore the possibilities.

You'll find ColorView and ColorCoach at:

www.certainteed.com/colorview

- ARBOR BLEND
- ARTIC BLEND
- WEATHERED BLEND
- FRONTIER BLEND
- TIMBER BLEND
- CANYON BLEND
- MEADOW BLEND
- GLACIER BLEND
- AUTUMN RED
- TERRA COTTA
- MOUNTAIN CEDAR
- SABLE BROWN
- HEARTHSTONE
- SUEDE
- SPRUCE
- FOREST
- IVY GREEN
- PACIFIC BLUE
- FLAGSTONE
- CHARCOAL GRAY
- GRANITE GRAY
- STERLING GRAY
- BERMUDA BLUE
- OXFORD BLUE
- SEAGRASS
- CYPRESS
- GREEN TEA
- LINEN
- SILVER ASH
- HERRINGBONE
- SANDSTONE BEIGE
- DESERT TAN
- NATURAL CLAY
- SAVANNAH WICKER
- LIGHT MAPLE
- BUCKSKIN
- SANDPIPER
- HERITAGE CREAM
- AUTUMN YELLOW
- SNOW
- COLONIAL WHITE

Vinyl Carpentry®

Pre-formed decorative accents and trim pieces with the authentic look of painted wood add distinction to windows, doors, corners, gables and frieze boards.

- **Design:** styles range from functional trim to crown and cornice moldings to corner blocks, rosettes and lineals.
- **Performance:** solid construction for impact resistance and durability, with PermaColor™ lifetime fade protection.
- **Colors:** over 40 hues that match CertainTeed siding colors for maximum design flexibility.

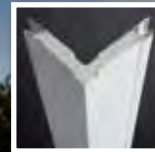

Outside Corners



Lineals



Inside Corners

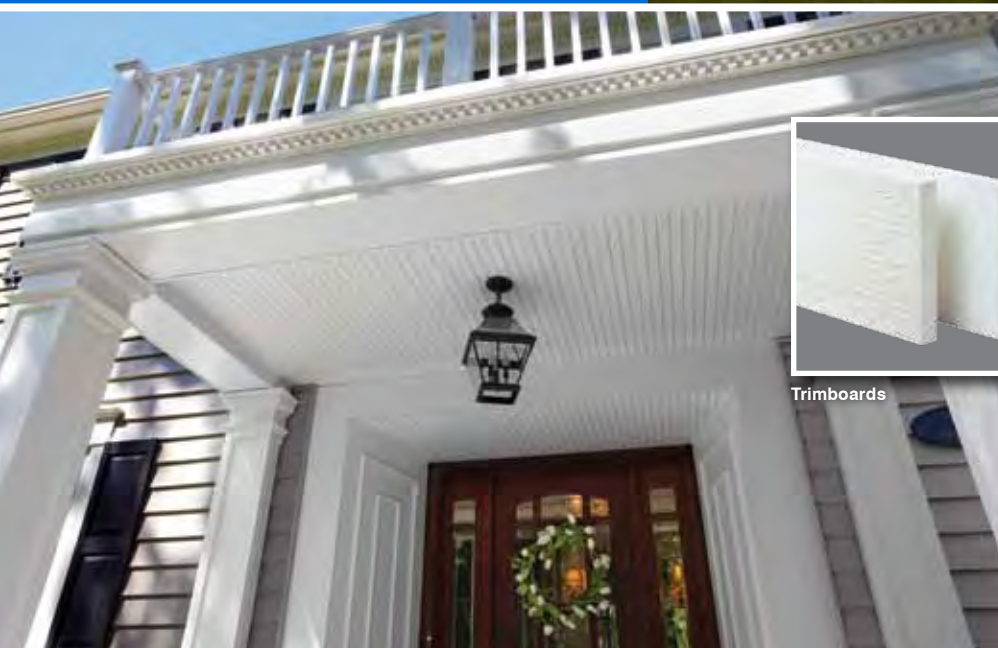

Trimboards

Restoration Millwork & Cellular PVC Trim

Cuts, mills, shapes and routes like the finest top-grade lumber.

- **Design:** products pre-engineered in all standard sizes; can also be cut and milled to create an unlimited range of unique design elements.
- **Performance:** long-lasting UV-resistant material with excellent dimensional accuracy and performance.
- **Colors:** natural white for a ready-to-install classic look or easily painted with vinyl-safe paint for maximum customizability.

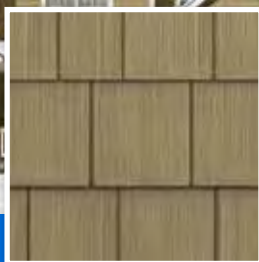

Double 7" Straight Edge Perfection Shingles

Cedar Impressions®

Shake- or shingle-style siding is an attractive accent option for your home's architectural features (like dormers and gables), and a great way to convey eye-catching curb appeal.

- **Design:** 6 style options with TrueTexture™ finish from classic perfection style to rustic rough split shakes.
- **Performance:** engineered and tested to withstand hurricane force winds.
- **Colors:** 30 low-gloss colors to complement or contrast with CertainTeed siding.

EverNew® Railing, Porch and Decking

A wide variety of materials, styles and colors to expand your home's Living Spaces beyond four walls.

- **Design:** stylish options for porches, balconies, stairs and walkways.
- **Performance:** Features heavy-duty construction for enduring strength and integrity.
- **Colors:** subtle earth tones harmonize with siding and landscaping.

EverNew Kingston railing





CertainTeed products are designed to work together and complement each other in color and style to give your home a beautiful finished look.



Polymer Shakes & Shingles



Roofing and Ventilation



Fence



Insulated Siding



PVC Exterior Trim & Beadboard



Decking and Railing



Vinyl Siding



Vinyl Carpentry® Trim



Housewrap



Professional: [facebook.com/CertainTeedFreedomofChoice](https://www.facebook.com/CertainTeedFreedomofChoice)
Consumer: [facebook.com/CertainTeedLivingSpaces](https://www.facebook.com/CertainTeedLivingSpaces)

[**Be Certain**] Confidence worth building on.™

ASK ABOUT OUR OTHER CERTAINTEED® PRODUCTS AND SYSTEMS:

ROOFING • SIDING • TRIM • DECKING • RAILING • FENCE
 GYPSUM • CEILINGS • INSULATION

www.certainteed.com <http://blog.certainteed.com>

CertainTeed Corporation
 P.O. Box 860
 Valley Forge, PA 19482

Professional: 800-233-8990
Consumer: 800-782-8777

© 4/14 CertainTeed Corporation, Printed in U.S.A.
 Code No. CTS373

