

WEST PLACE PHASE 1 LUMINAIRE SCHEDULE

QTY	TYPE	DESCRIPTION	CCT	NOMINAL DELIVERED LUMENS	NOMINAL WATTAGE	MFTR	MODEL #	NOTES
18	C1A	J-BOX MOUNT CEILING SURFACE DOWNLIGHT	3500	800	13W	HALO	SLD606-835-WH	
74	C1B	J-BOX MOUNT CEILING SURFACE DOWNLIGHT	3500	1215	15W	HALO	SLD612-835WH	
42	C2	SURFACE MOUNT DOWNLIGHT	3000	900	12W	HALO	ML4D-09-NFL-930-E-TL43R-MVVV-HS4R	
358	PG1	SURFACE MOUNT VAPOR TIGHT	3500	4000	38	METALUX	4VT2-LD4-4-DR-UNV-L835-CD1	
0	PG1A	SURFACE MOUNT VAPOR TIGHT	3500	4000	38	METALUX	4VT2-LD4-4-DR-UNV-L835-CD1	PERIMETER ON DAYLIGHT SENSORS VERIFY LOCATION AND TYPE OF DAYLIGHT SENSOR QUANTITIES TO BE DETERMINED AND DEDUCTED FROM PG1
2	PL1B	PARKING POLE MOUNTED LUMINAIRE PROVIDE WITH 18' ROUND STRAIGHT STEEL POLE. TYPE III DISTRIBUTION.	3000	10,782	113	MCGRW-EDISON	GALLEON GLEON-AF02-LED-E1-SL3-XX-7030 HAPCO RSS18B4-4-XX	SELECT FINISH CALCULATED ON 2'-6" RAISED BASE.
2	PL1C	DOUBLE HEADED PARKING POLE MOUNTED LUMINAIRE PROVIDE WITH 18' ROUND STRAIGHT STEEL POLE. TYPE IV DISTRIBUTION.	3000	10845 x 2	113	MCGRW-EDISON	GALLEON 2 HEAD GLEON-AF02-LED-E1-T4FT-XX-7030 HAPCO RSS18B4-4-XX	SELECT FINISH CALCULATED ON 2'-6" RAISED BASE.
15	PL1D	PARKING POLE MOUNTED LUMINAIRE PROVIDE WITH 18' ROUND STRAIGHT STEEL POLE. TYPE IV DISTRIBUTION.	3000	10,845	113	MCGRW-EDISON	GALLEON GLEON-AF02-LED-E1-5WQ-XX-7030 HAPCO RSS18B4-4-XX	SELECT FINISH CALCULATED ON 2'-6" RAISED BASE.
4	PL2B	PEDESTRIAN POLE MOUNTED LUMINAIRE. PROVIDE WITH 14' ROUND STRAIGHT STEEL POLE. TYPE III DISTRIBUTION.	3000	5,517	59	MCGRW-EDISON	GALLEON GLEON-AF01-LED-E1-SL3-XX-7030 HAPCO RSS14B4-4-XX	
4	PL2C	PEDESTRIAN POLE MOUNTED LUMINAIRE. PROVIDE WITH 14' ROUND STRAIGHT STEEL POLE. TYPE IV DISTRIBUTION.	3000	5,550	59	MCGRW-EDISON	GALLEON GLEON-AF01-LED-E1-T4FT-XX-7030 HAPCO RSS14B4-4-XX	
7	PL2CH	PEDESTRIAN POLE MOUNTED LUMINAIRE. PROVIDE WITH 14' ROUND STRAIGHT STEEL POLE. TYPE IV, INTEGRAL HOUSE SIDE SHIELD DISTRIBUTION.	3000	5,550	59	MCGRW-EDISON	GALLEON GLEON-AF01-LED-E1-SL4-XX-HSS-7030 HAPCO RSS14B4-4-XX	
2	PL2D	PEDESTRIAN POLE MOUNTED LUMINAIRE. PROVIDE WITH 14' ROUND STRAIGHT STEEL POLE. TYPE V DISTRIBUTION.	3000	11,355	59	MCGRW-EDISON	GALLEON GLEON-AF02-LED-E1-5WQ-XX-7030 HAPCO RSS14B4-4-XX	
336	S	TREE MOUNTED STRING LIGHTS	3000	33	0.5	TIVOLI	LIGHT SPHERE CLEAR	
127	SL1	RECESSED STEPLIGHT. MOUNT AT 24" AFG.	3000	44	6	FC LIGHTING	FCSL550-VOLTAGE-LED-3K-95-XX	SELECT FINISH
26	SL2	RAIL MOUNTED STEPLIGHT. MOUNT AT 24" AFG.	3000	26	3	COLE LIGHTING	C1392DW-LED-2	
33	W1	WALL MOUNTED EXTERIOR INDIRECT	3500	4051	55W	AMETRIX	ASYX-WM-S-1-OD-U-W-L35-UNV-XX-C-STD	SELECT FINISH
10	W2	WALL MOUNTED OVAL BULKHEAD. MOUNT HORIZONTALLY ABOVE DOOR.	3000	1140	13.5	LUMINAIRE LED	AOV13-3000K-120-277-OP-XX	SELECT FINISH
27	W3	WALL MOUNTED DOWNLIGHT	3000	1875	43	FC LIGHTING	FCCSQ410-XXX-LED-3K-1800-XX-WFL	SELECT FINISH
8	W4	WALL MOUNTED DOWNLIGHT	3000	49	2.5	MP LIGHTING	L91-2-W30S-W-C-0-A-MA	
20	W5	WALL MOUNTED SCONCE	3000	458	12	EUREKA	PLATE OUT 3450-2XLED.6.30-VOLT-FINISH	SELECT FINISH

DESCRIPTION

The Halo Surface LED Downlight (SLD) incorporates WaveStream™ technology to create an ultra-low profile surface mounting luminaire with the performance and look of a traditional downlight. SLD6 is designed for installation in many 3-1/2" and 4" square, octagon or round junction boxes. And may also retrofit in 5" and 6" IC and Non-IC recessed housings.* Suitable for residential or commercial installations. Ideal for closets, storage areas, attics and basements. Compliant with NFPA® 70, NEC® Section 410.16 (A)(3) and 410.16 (C)(5).

Catalog #		Type
Project		
Comments		Date
Prepared by		

SPECIFICATION FEATURES

CONSTRUCTION

- Die cast aluminum trim ring, and die formed aluminum frame

OPTICS

- WaveStream™ technology provides uniform luminance from a low profile flat lens
- AccuAim™ optics provide directional control for the "cone-of-light" beam distribution of a traditional downlight.
- Precision molded lens features high transmission polymer with UV stabilized protecting film

DESIGNER TRIMS

Accessories (sold separately)

SLD designer trims are accessory rings that attach to the SLD for a permanent finish. Refer to SLD accessories specification sheet for details.

- White (Paintable)
- Satin Nickel
- Tuscan Bronze

ELECTRICAL JUNCTION BOX MOUNTING

- SLD may be used in compatible electrical junction boxes in direct contact with insulation including spray foam insulation
- Suitable for installation in many 3-1/2" and 4" square, octagon, and round electrical junction boxes

Note: Driver consumes 3 cubic inches of junction box

- Surface mounting in a fire-rated ceiling using an appropriate electrical box offers a cost-effective alternative to fire-rated recessed housings

Note: Fire-rating is per the rating of the ceiling and applicable junction box, not the SLD.

- Installer must ensure compatibility of fit, wiring and proper mounting in the electrical junction box. This

includes all applicable national and local electrical and building codes

- Proprietary Slot-N-Lock quick installation system for junction box installation
- T-bracket with Slot-N-Lock mounting tabs included

RECESSED HOUSING MOUNTING

- May be installed in IC recessed housings in direct contact with insulation
- * **Note:** Not for use in recessed housings in direct contact with spray foam insulation. Refer to NEMA LSD 57-2013

Torsion Spring 5" & 6"

- Optional precision formed torsion spring bracket kit is included
- The torsion springs adjust on the frame to fit 5" or 6" compatible housings

Friction Blade 5" & 6"

- Optional precision formed friction blades included
- For retrofit in 5" and 6" housings without torsion spring mounting tabs
- Friction blade design allows the SLD to be installed in any position within the housing aperture (360 degrees)

LED

- Trilateral linear LED assembly is integrated in trim perimeter
- Color Temperature: 2700K, 3000K, 3500K, 4000K
- CRI options: 80 and 90
 - 90 CRI can be used for California Title 24 compliance/certified to Title 20
 - 80 CRI can be used to comply with California Title 24 Non-Residential Lighting Controls as a LED luminaire.
- L70 at 50,000 hours projected in accordance with TM-21

WARRANTY

Cooper Lighting provides a five year limited warranty on the SLD LED

LED CHROMATICITY

- A tight chromaticity specification ensures LED color uniformity, sustainable Color Rendering Index (CRI) and Correlated Color Temperature (CCT) over the useful life of the LED
- LED chromaticity of 3 SDCM exceeds ENERGY STAR® color standards per ANSI.
- 90 CRI model features high color performance with R9 greater than 50
- Every Halo LED is quality tested, measured, and serialized in a permanent record to register lumens, wattage, CRI and CCT.
- Halo LED serialized testing and measurement ensures color and lumen consistency on a per-unit basis, and validates long-term product consistency over time

ELECTRICAL CONNECTIONS
Junction Box

- Compatible with 3-1/2" x 2" and 4" x 1-1/2" deep round, square and octagon boxes (2-1/8" deep boxes recommended)
- Supply Wire Adapter with LED quick connector included

Recessed Housings

- LED connector is compatible with Halo 5" H550 Series and 6" H750 Series LED Housings
- LED Connector meets California Title-24 high-efficacy luminaire standard as a non-screw base
- The included E26 Edison screw-base adapter provides capability for retrofit
- LED connector is a non-screwbase luminaire disconnect for tool-less installation



SLD 600 Series

SLD6068xxWH

80CRI
2700K, 3000K, 3500K,
and 4000K

SLD6069xxWH

90CRI
2700K, 3000K, 3500K,
and 4000K

6" Surface LED Downlight

Suitable for ceiling or wall electrical junction boxes

Suitable for 5" & 6" recessed housing retrofit (IC, Non-IC & AIR-TITE™)

ENERGY DATA

	80 CRI	90 CRI
Lumens (4000K models)	800	780
Input Voltage	120V	120V
Frequency	50/60 Hz	50/60 Hz
Input Current	0.10 A	0.11 A
Input Power	12.2 W	13.2 W
Efficiency (4000K models)	66 lm/W	59 lm/W
THD	≤ 20%	
Power Factor	≥ 0.90	
T Ambient	-30 - +40°C	
Sound Rating	Class A	

NOMENCLATURE

SLD 606 8 30 WH
606 = 6" SLD 600 Series
8 = >80 CRI
30 = 3000K
WH = Matte White

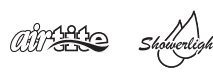
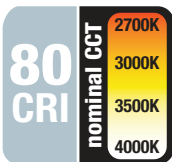

Refer to ENERGY STAR® Certified Products List. Can be used to comply with California Title 24 Non-Residential Lighting Controls requirements as a LED Luminaire.

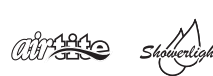

Refer to ENERGY STAR® Certified Products List. Can be used to comply with California Title 24 High Efficacy requirements. Certified to California Title 20 Appliance Efficiency Database.

LED DRIVER

- Driver is a 120V input, high efficiency, dimmable electronic power supply providing DC power to the LED array
- Driver features high power factor, low THD, and has integral thermal protection in the event of over temperature or internal failure
- Driver is replaceable if it should be required

DIMMING

- Designed for continuous dimming capability to nominally 5% with many 120V Leading Edge (LE) and Trailing Edge (TE) phase control dimmers. Dimming to 5% is best assured using dimmers with low end trim adjustment. Consult dimmer manufacturer for compatibility and conditions of use. (Note some dimmers require a neutral in the wallbox.)

COMPLIANCE

- cULus Listed ceiling and wall
- cULus Damp Location listed ceiling and wall
- cULus Wet Location Listed, ceiling only (shower rated)
- Suitable for use in closets, compliant with NFPA® 70, NEC® Section 410.16 (A)(3) and 410.16 (C)(5)
- SLD may be used in compatible electrical junction boxes in direct contact with insulation including spray foam insulation
- May be installed in IC recessed housings in direct contact with insulation (Not for use in recessed housings in direct contact with spray foam insulation. Refer to NEMA LSD 57-2013)
- UL Classified when used in retrofit with listed housings (See Housing Compatibility)
- EMI/RFI: meets FCC 47CFR Part 15 Class B limits, and is suitable for use in residential and commercial installations
- Airtight certified per ASTM E283 (not exceeding 2.0 CFM under 57 Pascals pressure difference)
- 90 CRI: Can be used to comply with California Title 24 High Efficacy requirements. Certified to California Title 20 Appliance Efficiency Database.
- 80 CRI: Can be used to comply with California Title 24 Non-Residential Lighting Controls requirements as a LED luminaire.
- Can be used for International Energy Conservation Code (IECC) and Washington State Energy Code high efficiency luminaire compliance
- ENERGY STAR® certified luminaire - consult ENERGY STAR® Certified Product List
- Contains no mercury or lead and RoHS compliant.
- Photometric testing in accordance with IES LM-79
- Lumen maintenance projections in accordance with IES LM-80 and TM-21



SLD 600 Series SLD6068xxWH

80CRI
2700K, 3000K, 3500K,
and 4000K

SLD6069xxWH

90CRI
2700K, 3000K, 3500K,
and 4000K

6" Surface LED Downlight

Suitable for
ceiling or wall
electrical junction boxes

Suitable for
5" & 6" recessed
housing retrofit
(IC, Non-IC & AIR-TITE™)

DIMENSIONS

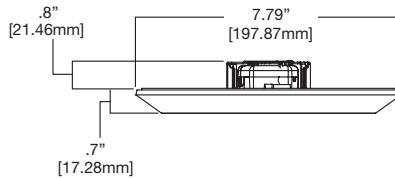
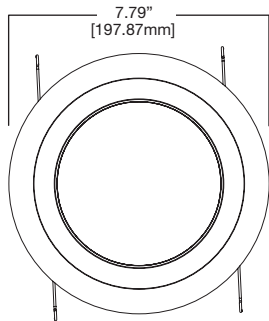

ORDERING INFORMATION

SAMPLE NUMBER: SLD606927WH SLD6TRMSN

Junction Box Installation: Order junction box separately, as supplied by others, to complete installation.

Recessed Installation: Order Halo recessed housing separately to complete installation.

Models	Color Rendering Index	Color Temperature (CCT)	Finish	Accessories
SLD606= 6" Surface LED Downlight, 120V 600 Series	8=80 CRI 9=90 CRI	27=2700K 30=3000K 35=3500K 40=4000K	WH=White	<p>Designer Trims Fit over the SLD for a designer finish SLD6TRMSN=6" SLD Satin Nickel SLD6TRMTBZ=6" SLD Tuscan Bronze SLD6TRMWH=6" SLD White (paintable)</p> <p>J-Box Spacer Extension Ring Add 15/16" depth when SLD driver cannot fit into installed junction box SLD6EXT=6" Surface LED J-Box Extender, 9.5" O.D.</p> <p>RAD Adapters When junction box is mounted flat on a ceiling or beam surface (not recessed in ceiling) SLD6RAD=6" SLD Round Surface J-Box Adapter, 7.92" O.D. (for 4-inch round or octagon junction boxes.) SLD6SADPLT=6" SLD Square Surface J-Box Adapter Plate (For 4-inch square junction boxes, use with SLD6RAD.)</p> <p>Spare Parts SLD6ACCKIT=6" Accessory Parts Replacement Kit (Screwbase adapter, torsion springs, friction blades) SLD6BRKT=6" Junction Box Bracket & Screws</p> <p>Refer to SLD Accessories specification sheet for further information.</p>



Photometric Report (Type C)

Filename: C1A_SLD606835WH.ies
 [TEST] P166799 TEST IS SCALED FROM IESNA LM-79-08 TEST DATA (P14660)
 [TESTLAB] INNOVATIONS CENTER-P1
 [ISSUE DATE] 3/31/2015
 [MANUFAC] EATON - HALO (FORMER COOPER LIGHTING)
 [LUMCAT] SLD606835WH
 [LUMINAIRE] HALO 6 INCH SURFACE LED DOWNLIGHT
 [LAMP] LED 80CRI / 3500K CCT

Maximum Candela = 266.3 at 0 H 20 V

Classification:

Road Classification: Type V, Very Short, N.A. (deprecated)
 Upward Waste Light Ratio: 0.00
 Luminaire Efficacy Rating (LER): 64
 Indoor Classification: Direct
 BUG Rating : B1-U0-G0

LCS Summary:

LCS Zone	Lumens	%Lamp	%Lum
FL (0-30)	110.1	N.A.	14.1
FM (30-60)	213.5	N.A.	27.4
FH (60-80)	59.1	N.A.	7.6
FVH (80-90)	7.3	N.A.	0.9
BL (0-30)	110.1	N.A.	14.1
BM (30-60)	213.5	N.A.	27.4
BH (60-80)	59.1	N.A.	7.6
BVH (80-90)	7.3	N.A.	0.9
UL (90-100)	0.0	N.A.	0.0
UH (100-180)	0.0	N.A.	0.0
Total	780.0	N.A.	100.0
BUG Rating	B1-U0-G0		

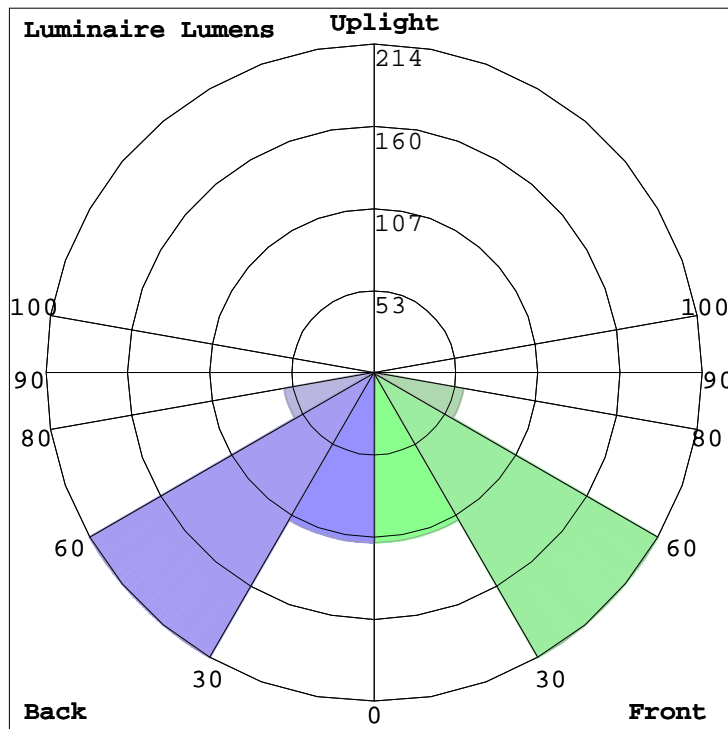

DESCRIPTION

The Halo Surface LED Downlight (SLD) incorporates WaveStream™ technology to create an ultra-low profile surface mounting luminaire with the performance and look of a traditional downlight. SLD6 is designed for installation in many 3-1/2" and 4" square, octagon or round junction boxes. And may also retrofit in 5" and 6" IC and Non-IC recessed housings.* Suitable for residential or commercial installations. Ideal for closets, storage areas, attics and basements. Compliant with NFPA® 70, NEC® Section 410.16 (A)(3) and 410.16 (C)(5).

Catalog #		Type
Project		
Comments		Date
Prepared by		

SPECIFICATION FEATURES

CONSTRUCTION

- Die cast aluminum trim ring, and die formed aluminum frame

OPTICS

- WaveStream™ technology provides uniform luminance from a low profile flat lens
- AccuAim™ optics provide directional control for the "cone-of-light" beam distribution of a traditional downlight.
- Precision molded lens features high transmission polymer with UV stabilized protecting film

DESIGNER TRIMS

Accessories (sold separately)

SLD designer trims are accessory rings that attach to the SLD for a permanent finish.* Refer to SLD accessories specification sheet for details.

- White (Paintable)
- Satin Nickel
- Tuscan Bronze

*SLD accessory trims attach with permanent adhesion and are not interchangeable after installation.

ELECTRICAL JUNCTION BOX MOUNTING

- SLD may be used in compatible electrical junction boxes in direct contact with insulation including spray foam insulation
- Suitable for installation in many 3-1/2" and 4" square, octagon, and round electrical junction boxes
- Note:** Driver consumes 3 cubic inches of junction box
- Surface mounting in a fire-rated ceiling using an appropriate electrical box offers a cost-effective alternative to fire-rated recessed housings
- Note:** Fire-rating is per the rating of the ceiling and applicable junction box, not the SLD.
- Installer must ensure compatibility of fit, wiring and

proper mounting in the electrical junction box. This includes all applicable national and local electrical and building codes.

- Proprietary Slot-N-Lock quick installation system for junction box installation
- T-bracket with Slot-N-Lock mounting tabs included

RECESSED HOUSING MOUNTING

- May be installed in IC recessed housings in direct contact with insulation

* **Note:** Not for use in recessed housings in direct contact with spray foam insulation. Refer to NEMA LSD 57-2013

Torsion Spring 5" & 6"

- Optional precision formed torsion spring bracket kit is included
- The torsion springs adjust on the frame to fit 5" or 6" compatible housings

Friction Blade 5" & 6"

- Optional precision formed friction blades included
- For retrofit in 5" and 6" housings without torsion spring mounting tabs
- Friction blade design allows the SLD to be installed in any position within the housing aperture (360 degrees)

LED

- Linear LED arrays are integrated in trim perimeter
- Color Temperature: 2700K, 3000K, 3500K, 4000K
- CRI options: 80 and 90
 - 90 CRI can be used for California Title 24 compliance/certified to Title 20
 - 80 CRI can be used to comply with California Title 24 Non-Residential Lighting Controls as a LED luminaire.

WARRANTY

Cooper Lighting provides a five year limited warranty on the SLD LED

LED CHROMATICITY

- A tight chromaticity specification ensures LED color uniformity, sustainable Color Rendering Index (CRI) and Correlated Color Temperature (CCT) over the useful life of the LED
- LED chromaticity of 3 SDCM exceeds ENERGY STAR® color standards per ANSI.
- 90 CRI model features high color performance with R9 greater than 50
- Every Halo LED is quality tested, measured, and serialized in a permanent record to register lumens, wattage, CRI and CCT.
- Halo LED serialized testing and measurement ensures color and lumen consistency on a per-unit basis, and validates long-term product consistency over time

ELECTRICAL CONNECTIONS Junction Box

- Compatible with 3-1/2" x 2" and 4" x 1-1/2" deep round, square and octagon boxes (2-1/8" deep boxes recommended)
- Supply Wire Adapter with LED quick connector included
- Recessed Housings**
 - LED connector is compatible with Halo 5" H550 Series and 6" H750 Series LED Housings
 - LED Connector meets California Title-24 high-efficacy luminaire standard as a non-screw base
 - The included E26 Edison screw-base adapter provides capability for retrofit
 - LED connector is a non-screwbase luminaire disconnect for tool-less installation



SLD 1200 Series

SLD6128xxWH

80CRI
2700K, 3000K, 3500K, and 4000K

SLD6129xxWH

90CRI
2700K, 3000K, 3500K, and 4000K

6" Surface LED Downlight

High Lumen 1200 Series

Suitable for ceiling or wall electrical junction boxes

Suitable for 5" & 6" recessed housing retrofit (IC, Non-IC & AIR-TITE™)

ENERGY DATA

	80 CRI	90 CRI
Lumens (4000K models)	1215	1000
Input Voltage	120V	120V
Frequency	50/60 Hz	50/60 Hz
Input Current	0.12 A	0.12 A
Input Power	14.8 W	14.8 W
Efficiency (4000K models)	82 lm/W	68 lm/W
THD	≤ 20%	
Power Factor	≥ 0.90	
T Ambient	-30 - +40°C	
Sound Rating	Class A	

NOMENCLATURE

SLD 612 8 30 WH
 612 = 6" SLD 1200 Series
 8 = >80 CRI
 30 = 3000K
 WH = Matte White

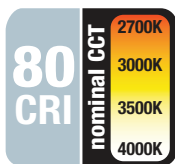

Refer to ENERGY STAR® Certified Products List. Can be used to comply with California Title 24 Non-Residential Lighting Controls requirements as a LED Luminaire.



Refer to ENERGY STAR® Certified Products List. Can be used to comply with California Title 24 High Efficacy requirements. Certified to California Title 20 Appliance Efficiency Database.

LED DRIVER

- Driver is a 120V input, high efficiency, dimmable electronic power supply providing DC power to the LED arrays
- Driver features high power factor, low THD, and has integral thermal protection in the event of over temperature or internal failure
- Driver is replaceable if it should be required

DIMMING

- Designed for continuous dimming capability to nominally 5% with many 120V Leading Edge (LE) and Trailing Edge (TE) phase control dimmers. Dimming to 5% is best assured using dimmers with low end trim adjustment. Consult dimmer manufacturer for compatibility and conditions of use. (Note some dimmers require a neutral in the wallbox.)

COMPLIANCE

- cULus Listed ceiling and wall
- cULus Damp Location listed ceiling and wall
- cULus Wet Location Listed, ceiling only (shower rated)
- Suitable for use in closets, compliant with NFPA® 70, NEC® Section 410.16 (A)(3) and 410.16 (C)(5)
- SLD may be used in compatible electrical junction boxes in direct contact with insulation including spray foam insulation
- May be installed in IC recessed housings in direct contact with insulation (Not for use in recessed housings in direct contact with spray foam insulation. Refer to NEMA LSD 57-2013)
- UL Classified when used in retrofit with listed housings (See Housing Compatibility)
- EMI/RFI: meets FCC 47CFR Part 15 Class B limits, and is suitable for use in residential and commercial installations
- Airtight certified per ASTM E283 (not exceeding 2.0 CFM under 57 Pascals pressure difference)
- 90 CRI: Can be used to comply with California Title 24 High Efficacy requirements. Certified to California Title 20 Appliance Efficiency Database.
- 80 CRI: Can be used to comply with California Title 24 Non-Residential Lighting Controls requirements as a LED luminaire.
- Can be used for International Energy Conservation Code (IECC) and Washington State Energy Code high efficiency luminaire compliance
- ENERGY STAR® certified luminaire - consult ENERGY STAR® Certified Product List
- Contains no mercury or lead and RoHS compliant.
- Photometric testing in accordance with IES LM-79
- Lumen maintenance projections in accordance with IES LM-80 and TM-21



SLD 1200 Series

SLD6128xxWH

80CRI

2700K, 3000K, 3500K,
and 4000K

SLD6129xxWH

90CRI

2700K, 3000K, 3500K,
and 4000K

6" Surface LED
Downlight

High Lumen 1200 Series

Suitable for
ceiling or wall
electrical junction boxes

Suitable for
5" & 6" recessed
housing retrofit
(IC, Non-IC & AIR-TITE™)

DIMENSIONS

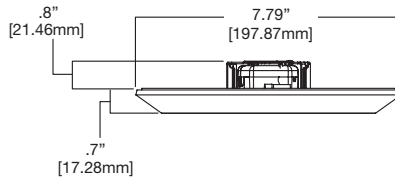
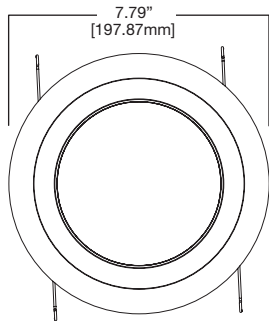

ORDERING INFORMATION

SAMPLE NUMBER: SLD612927WH SLD6TRMSN

Junction Box Installation: Order junction box separately, as supplied by others, to complete installation.

Recessed Installation: Order Halo recessed housing separately to complete installation.

Models	Color Rendering Index	Color Temperature (CCT)	Finish	Accessories
SLD612= 6" Surface LED Downlight, 120V 1200 Series	8=80 CRI 9=90 CRI	27=2700K 30=3000K 35=3500K 40=4000K	WH=White	<p>Designer Trims Fit over the SLD for a designer finish SLD6TRMSN=6" SLD Satin Nickel SLD6TRMTBZ=6" SLD Tuscan Bronze SLD6TRMWH=6" SLD White (paintable) *SLD accessory trims attach with permanent adhesion and are not interchangeable after installation</p> <p>J-Box Spacer Extension Ring Add 15/16" depth when SLD driver cannot fit into installed junction box SLD6EXT=6" Surface LED J-Box Extender, 9.5" O.D.</p> <p>RAD Adapters When junction box is mounted flat on a ceiling or beam surface (not recessed in ceiling) SLD6RAD=6" SLD Round Surface J-Box Adapter, 7.92" O.D. (for 4-inch round or octagon junction boxes.) SLD6SADPLT=6" SLD Square Surface J-Box Adapter Plate (For 4-inch square junction boxes, use with SLD6RAD.)</p> <p>Spare Parts SLD6ACCKIT=6" Accessory Parts Replacement Kit (Screwbase adapter, torsion springs, friction blades) SLD6BRKT=6" Junction Box Bracket & Screws</p> <p>Refer to SLD Accessories specification sheet for further information.</p>



Photometric Report (Type C)

Filename: C1B_SLD612835WH.ies
 [TEST] P177850 TEST IS SCALED FROM IESNA LM-79-08 TEST
 DATA (P26354)
 [TESTLAB] INNOVATIONS CENTER-P2
 [ISSUEDATE] 7/13/2015
 [MANUFAC] EATON - HALO (FORMER COOPER LIGHTING)
 [LUMCAT] SLD612835WH
 [LUMINAIRE] HALO 6 INCH SURFACE LED DOWNLIGHT
 [LAMP] LED 80CRI / 3500K CCT

Maximum Candela = 403.7 at 0 H 15 V

Classification:

Road Classification: Type V, Very Short, N.A. (deprecated)
 Upward Waste Light Ratio: 0.00
 Luminaire Efficacy Rating (LER): 81
 Indoor Classification: Direct
 BUG Rating : B1-U0-G1

LCS Summary:

LCS Zone	Lumens	%Lamp	%Lum
FL (0-30)	166.8	N.A.	13.9
FM (30-60)	330.1	N.A.	27.5
FH (60-80)	92.8	N.A.	7.7
FVH (80-90)	10.3	N.A.	0.9
BL (0-30)	166.8	N.A.	13.9
BM (30-60)	330.1	N.A.	27.5
BH (60-80)	92.8	N.A.	7.7
BVH (80-90)	10.3	N.A.	0.9
UL (90-100)	0.0	N.A.	0.0
UH (100-180)	0.0	N.A.	0.0
Total	1200.0	N.A.	100.0
BUG Rating	B1-U0-G1		

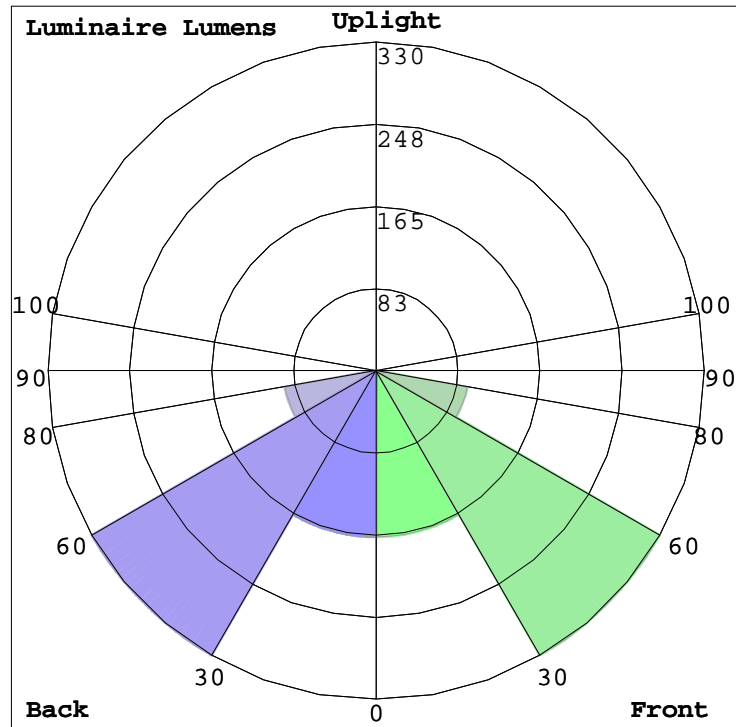

Description

Round or square housings adapt ML4 LED module and associated 2" aperture open, lens and lens wall wash trims to complete a surface mount luminaire. Installs to recessed or surface mounted junction boxes with hardware provided. Use with compatible Halo® LED integrated trims and modules providing general, task and accent lighting when energy savings, long life and optical control are required. Order LED module and trims separately.

Catalog #		Type
Project		
Comments		Date
Prepared by		

Specification Features

Housing

- Extruded aluminum round or square housing with die formed aperture accepts ML4 LED modules and trims.

Mounting

- Attaches directly to 3-1/2" and 4" round ceiling pans, 3-1/2" and 4" octagon boxes, 4" and 4-11/16" square fixture mud rings and single gang handy boxes with hardware provided.
- Spider plate allows for ±45° rotation to align square with architecture.

Gasket

- Provided with die cut white and black gasket for use in wet locations, covered ceilings only

Connector

- Two-conductor wire mount connector is rated for 120 - 277V and mates with ML4 LED integrated module.
- CAUTION – verify LED module input voltage is compatible with the input voltage of the housing. If uncertain, consult a qualified electrician.

Compliance

- cULus damp location listed with open trims, wet location listed, covered ceilings only and IP66 certified when used with supplied gasket and lens trims.
- Suitable for use in clothes closets when installed in accordance with the NEC 410.16 spacing requirements.
- Can be used for State of California Title 24 high efficacy luminaire compliance, reference the California Energy Commission Title 20 Appliance Efficiency Database for current listing

Warranty

One year limited warranty, consult website for details.
www.eaton.com/lighting/Legal



Dimensions

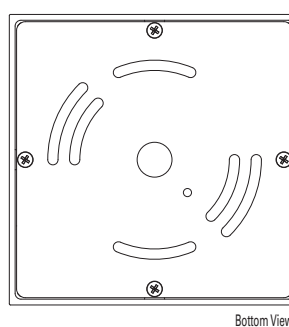
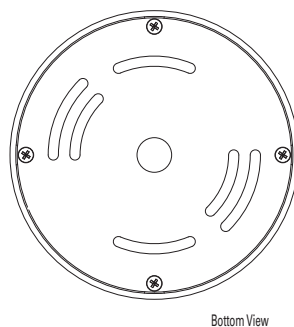
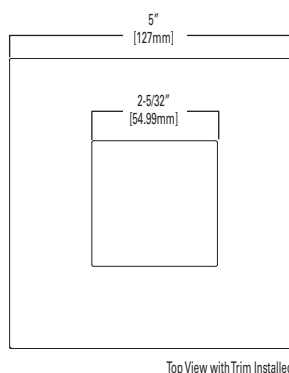
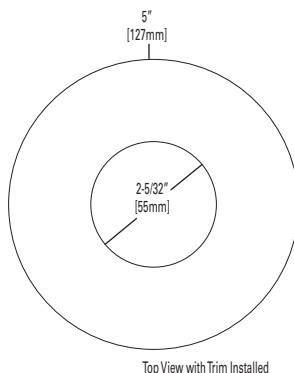
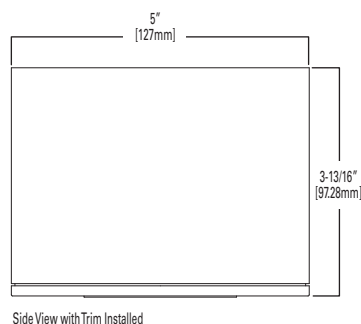

**HS4R
HS4S**
Round and Square
Surface Mount Housings

Use with ML4 LED module and 2" aperture open, lens and lens wall wash trims

Ordering Information

SAMPLE NUMBER: HS4RMW

A complete luminaire consists of a housing, LED module and trim, order separately.

Housing	Finish	Accessories
HS4R= Surface round, 120-277V HS4S= Surface square, 120-277V	MW=Matte white MB=Matte black	

Description

Recessed LED module with interchangeable 2-inch round or square lens pinhole apertures are available in various finishes to suit any décor. Use with 4-inch nominal recessed housings suitable for residential and shallow plenum commercial construction or can be used to retrofit existing installations. Field interchangeable primary optics provide various distribution patterns and spacing to mounting height ratios. Use for general and task lighting in low to medium height ceilings where energy savings, long life and optical control are required.

Specification Features

Module

- Field interchangeable and upgradable LED module consists of LED array, primary optic and driver.
- Integral die cast aluminum heat sink provides passive thermal cooling achieving L70 at 50,000 hours in IC and non-IC applications.

Retention

- Heat treated compression springs hold module securely in the housing, can be removed thru the aperture for service or replacement

LED Array

- Proximity phosphors over chip on board LEDs provide a uniform source with high efficiency and no pixilation.
- Available in 90 CRI minimum, R9 greater than 50 and color accuracy within 3 SDCM provide color accuracy and uniformity.
- Compatible with Zhaga book 12 standards for interchangeability and can be replaced in the field

Gaskets

- Closed cell gaskets achieve restrictive airflow requirements without additional caulking

Primary Optic

- Precision molded TIR optic organizes source flux into useful beams without stray lumens in the field.
- Two-piece construction with matte black mounting ring and polarized turn and lock mounting aligns optic to source and minimizes backlight in the housing.
- Exceeds ENERGY STAR® color angular uniformity requirements, color deviation is typically less than 0.002 u' v'.

- Available in narrow flood, flood and wide flood distributions, ordered separately, ships with narrow flood installed.
- Also available in asymmetric distribution providing vertical illumination

Trims

- Die formed steel trims are available in 2-inch round or square pinhole apertures and can be interchanged in the field.
- Available in a broad range of painted or plated finishes, can be painted in the field to match any décor.
- Magnetic attachment holds trim tightly to ceiling and eliminates light leaks.

Shielding

- Diffuse clear lens provides light control and source shielding.

Driver

- Integral UNV 120 - 277V 50/60 Hz constant current driver provides noise free operation.
- Continuous, flicker-free dimming from 100% to 5% with select leading or trailing edge 120V phase cut dimmers.
- Inline electrical quick connect and E26 adapter (provided) provides mains connection.
- Driver can be replaced in the field.

Compliance

- cULus listed / certified for use with Halo housings, classified for use with other's housings, see instruction sheet for conditions of acceptability.
- Wet location listed in covered ceilings and IP65 certified.
- Airtight per ASTM-E283.
- Suitable for use in clothes closets when installed in accordance with the NEC 410.16 spacing requirements
- EMI/RFI emissions per FCC 47CFR Part 15 B.
- Contains no mercury or lead and RoHS compliant.
- Photometric testing in accordance with IES LM-79-08.
- Lumen maintenance projections in accordance with IES LM-80-08 and TM-21-11.
- Can be used for State of California Title 24 high efficacy luminaire compliance, reference the California Energy Commission Title 20 Appliance Efficiency Database for current listings.
- ENERGY STAR® listed, reference qualified product listings.
- Meets State of California voluntary lamp standards.
- Zhaga book 12 compatible.

Warranty

Five year limited warranty, consult website for details.
www.eaton.com/lighting/Legal

Catalog #		Type
Project		
Comments		Date
Prepared by		



ML4D

TL43R

TL44S

900 Lumen Series

LED

2-Inch Round and Square Lens Pinhole Downlight



Refer to ENERGY STAR® Certified Products List. Can be used to comply with California Title 24 High Efficacy requirements. Certified to California Title 20 Appliance Efficiency Database.



Eaton is a founding member of the Zhaga Consortium

Dimensions

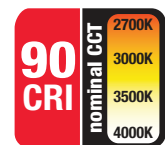
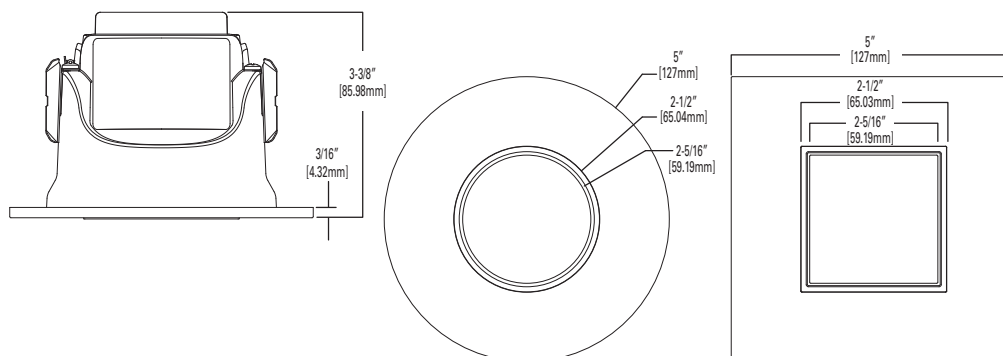

ENERGY DATA		
Lumens	900 Series	
Input Voltage	120V	277V
Input Current	101.6 (mA)	45.7 (mA)
Input Power	12.1 (W)	11.9 (W)
Efficiency	84.93 %	83.45 %
Inrush (A)	1.3	4.7
THD: ≤ 20%		
PF: ≥ 0.90		
T Ambient -40 - +40°C		
Sound Rating ≤ 20dba		

Ordering Information

SAMPLE NUMBER: ML4D09NFL927E - TL43R2GMWWB

A complete luminaire consists of a housing, LED module and trim, order separately.

Models	Lumens	Distribution	CRI/CCT	Driver	Accessories
ML4D = 4" LED module	09 =900 lumens (nominal)	NFL =25 degree narrow flood	927 =90 CRI , 2700K 930 =90 CRI , 3000K 935 =90 CRI , 3500K 940 =90 CRI , 4000K	E =UNV 120 - 277V 50-60Hz, LE & TE phase cut 5% dimming at 120V only	TIR50AWW25 =asymmetric wall wash TIR50NFL25 =25° narrow flood TIR50FL40 =40° flood TIR50WFL55 =55° wide flood LH501MB12PK =Media holder for (1) 50mm lens, matte black, 12 pack

Trims	Shielding	Flange Finish	Accessories
TL43R = 2" round lens pinhole TL44S = 2" square lens pinhole	2G =Diffuse clear	MWWB =Matte white flange, white lens frame MWBB =Matte white flange, black lens frame MBBB =Matte black flange, black lens frame BNBB =Brushed nickel flange, black lens frame ORBBB =Oil rubbed bronze flange, black lens frame GBBB =German bronze flange, black lens frame BCuBB =Brushed copper, black lens frame	T24HWKIT =Title 24 hard wire kit, converts incandescent, low voltage and compact fluorescent housings to LED

Housings
<p>H245RICAT=4" IC, airtight ultra-shallow remodeler housing, LED, 120 - 277V H99TAT=4" non-IC, airtight shallow new construction housing, E26, 120V H99RTAT=4" non-IC, airtight shallow remodeler housing, E26, 120V H99ICAT=4" IC, airtight shallow new construction housing, E26, 120V H995ICAT=4" IC, airtight shallow new construction housing, LED, 120 - 277V H995RICAT=4" IC, airtight shallow remodeler housing, LED, 120 - 277V E4TATSB=4" non-IC, airtight shallow new construction housing, adjustable socket bracket, E26, 120V E4RTATSB=4" non-IC, airtight shallow remodeler housing, adjustable socket bracket, E26, 120V E4ICATSB=4" non-IC, airtight shallow new construction housing, adjustable socket bracket, E26, 120V H4NCMF=4" new construction mounting frame HS4R=Surface round, 120-277V HS4S=Surface square, 120-277V</p>

Photometry

ML4D09NFL930-TIR50NFL25-TL43R2G_X_TL44S2GX

Description	Halo 2 Inch ML4 Round And Square Lensed Downlight-Narrow Flood Distribution
Test Number	P189395
Module	900 Series, 90CRI, Narrow Flood optic
Trim	2" Aperture, Open Round DL
Lumens	916 Lm
Efficacy	79.83
Spacing Criteria	0.39
CPCB	4688.3
Beam Angle (FWHM)	26.6

Color Metric Summary

TM-30-15	R _f = 91.5
	R _g = 97.7
CRI/CIE	R _a = 92.8
	R ₉ = 57.4



Candlepower Distribution

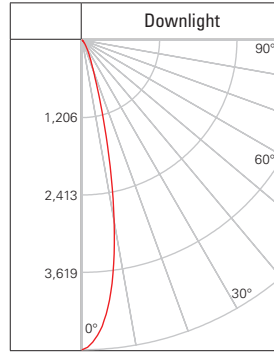

Candelas at Nadir

Angle	0-deg
0	4688
5	4166
10	2790
20	504
30	139
40	39
50	11
60	5
70	3
80	2
90	0

Foot-candle Values at Nadir

0 deg Aiming Angle		
DD	FC	DIA
5.5'	155	2
7'	95.7	2.6
8'	73.3	3
9'	57.9	3.4
10'	46.9	3.8
12'	32.6	4.6

DD = distance down to illuminated work plane
FC = initial foot-candles at nadir
DIA = diameter

ML4D09NFL930-TIR50FL40-TL43R2G_X_TL44S2GX

Description	Halo 2 Inch ML4 Round And Square Lensed Downlight- Flood Distribution
Test Number	P189401
Module	900 Series, 90CRI, Flood optic
Trim	2" Aperture, Open Round DL
Lumens	919 Lm
Efficacy	78.94
Spacing Criteria	0.64
CPCB	1868
Beam Angle (FWHM)	39.3

Color Metric Summary

TM-30-15	R _f = 91.4
	R _g = 97.7
CRI/CIE	R _a = 92.7
	R ₉ = 57.2

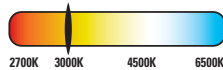

Candlepower Distribution

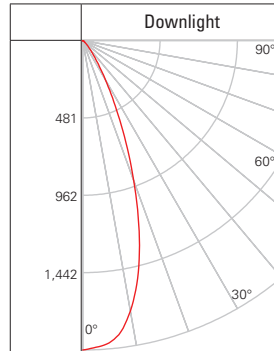

Candelas at Nadir

Angle	0-deg
0	1868
5	1832
10	1658
20	903
30	278
40	70
50	21
60	8
70	4
80	2
90	0

Foot-candle Values at Nadir

0 deg Aiming Angle		
DD	FC	DIA
5.5'	61.8	3.4
7'	38.1	4.4
8'	29.2	5
9'	23.1	5.8
10'	18.7	6.4
12'	13	7.6

DD = distance down to illuminated work plane
FC = initial foot-candles at nadir
DIA = diameter

ML4D09NFL930-TIR50WFL55-TL43R2G_X_TL44S2GX

Description	Halo 2 Inch ML4 Round And Square Lensed Downlight-Wide Flood Distribution
Test Number	P189407
Module	900 Series, 90CRI, Wide Flood optic
Trim	2" Aperture, Open Round DL
Lumens	857 Lm
Efficacy	74.41
Spacing Criteria	0.78
CPCB	1032.3
Beam Angle (FWHM)	52.1

Color Metric Summary

TM-30-15	R _f = 91.4
	R _g = 97.6
CRI/CIE	R _a = 92.7
	R ₉ = 57.1

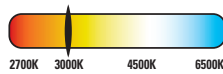

Candlepower Distribution

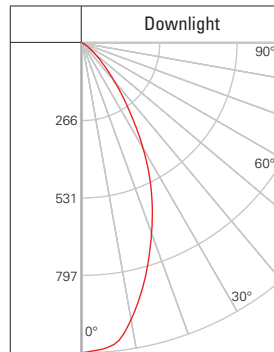

Candelas at Nadir

Angle	0-deg
0	1032
5	1017
10	936
20	675
30	406
40	166
50	54
60	16
70	5
80	1
90	0

Foot-candle Values at Nadir

0 deg Aiming Angle		
DD	FC	DIA
5.5'	34.1	4.2
7'	21.1	5.4
8'	16.1	6.2
9'	12.7	7
10'	10.3	7.8
12'	7.2	9.2

DD = distance down to illuminated work plane
FC = initial foot-candles at nadir
DIA = diameter

ML4D09NFL930-TIR50AWW25-TL43R2GMWWB_TL44S2GMWWB

Description	Halo 2 Inch ML4 Round And Square Lensed Downlight-Asymmetric
Test Number	P189448
Module	900 Series, 90CRI, Asymmetric
Trim	2" Aperture, Open Round DL
Lumens	683 Lm
Efficacy	61.03
Spacing Criteria	1.51
Peak intensity	2070
Peak angle	23

Color Metric Summary

TM-30-15	R _f = 91.4
	R _g = 97.6
CRI/CIE	R _a = 92.7
	R ₉ = 57.0

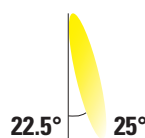
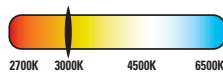

Candlepower Distribution

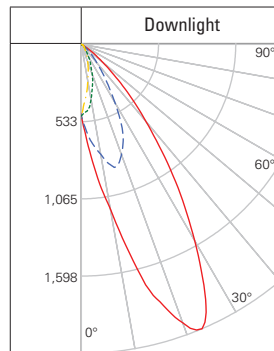

Candelas at Nadir

Angle	0-deg
0	479
5	751
10	1115
20	1986
30	1520
40	675
50	190
60	27
70	2
80	2
90	0

Single Unit Footcandles
2.5' from wall
(distance from fixture along wall)

DD	•
1'	0.4
2'	12.2
3'	28.9
4'	31.8
5'	26.5
6'	18.8
7'	12
8'	7.8
9'	5.2
10'	3.6

Multiplier Table

CCT Option	2700K	3000K	3500K	4000K
CCT Multiplier	0.946	1.000	1.020	1.042

Representative photometric test report for 3000K color temperature, 90CRI.
Multipliers may be used to determine relative lumen values with other color temperatures.



Photometric Report (Type C)

Filename: C2_ML4D09NFL930-TIR50NFL25-TL43R2G_X_TL44S2GX.ies
 [TEST] P189395 TEST IS SCALED FROM IESNA LM-79-08 TEST DATA (P27633)
 [TESTLAB] INNOVATION CENTER-P2
 [ISSUEDATE] 5/13/2016
 [MANUFAC] EATON - MCGRAW-EDISON (FORMER COOPER LIGHTING)
 [LUMCAT] ML4D09NFL930-TIR50NFL25-TL43R2G_X_TL44S2GX
 [LUMINAIRE] ML4 RECESSED DOWNLIGHT WITH 25° NARROW FLOOD OPTIC WITH LENSED ROUND WHITE TRIM (OR SQUARE)
 [LAMPCAT] CLU711
 [LAMP] CITIZEN 3000K

Maximum Candela = 4688.3 at 0 H 0 V

Classification:

Road Classification: Type V, Very Short, N.A. (deprecated)
 Upward Waste Light Ratio: 0.00
 Luminaire Efficacy Rating (LER): 80
 Indoor Classification: Direct
 BUG Rating : B1-U0-G0

LCS Summary:

LCS Zone	Lumens	%Lamp	%Lum
FL (0-30)	419.0	N.A.	45.7
FM (30-60)	35.4	N.A.	3.9
FH (60-80)	3.1	N.A.	0.3
FVH (80-90)	0.7	N.A.	0.1
BL (0-30)	419.0	N.A.	45.7
BM (30-60)	35.4	N.A.	3.9
BH (60-80)	3.1	N.A.	0.3
BVH (80-90)	0.7	N.A.	0.1
UL (90-100)	0.0	N.A.	0.0
UH (100-180)	0.0	N.A.	0.0
Total	916.4	N.A.	100.0
BUG Rating	B1-U0-G0		

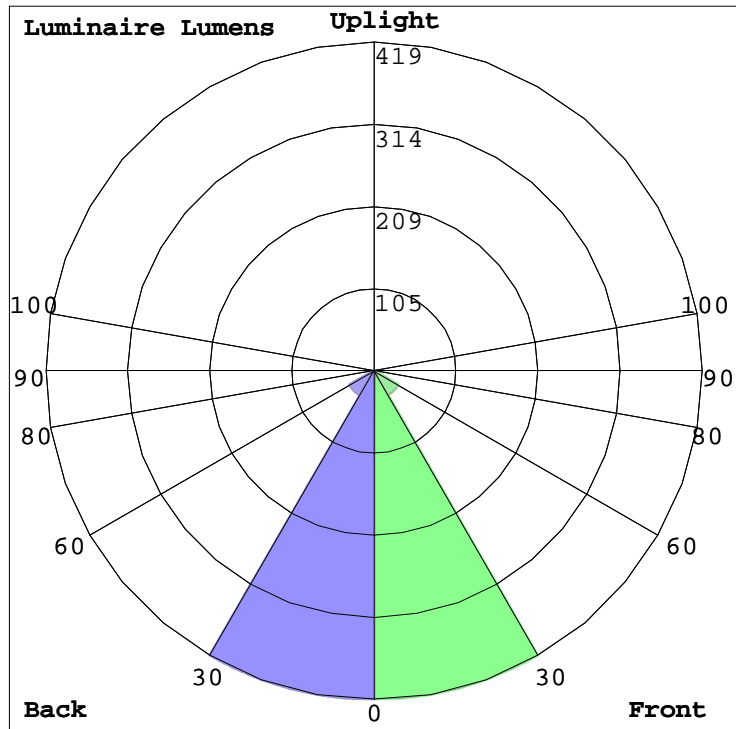

DESCRIPTION

The Vaportite LED Series is an energy efficient industrial Vaportite fixture that features rugged and durable construction. The Vaportite LED incorporates a full metal fixture liner inside a reinforced fiberglass housing with a high impact diffuser. This Vaportite series is suitable for interior and exterior applications and can be surface or chain mounted.

The Vaportite LED Series has been designed for maximum operation in commercial institutional and industrial environments and can operate in a wide range of temperatures (-20°C to 25°C) and is ideal for cold storage environments.

SPECIFICATION FEATURES

Construction

Fiberglass housing is reinforced polyester and self-extinguishing (ASTM-D635-74) plastic of a permanent pearl gray color. A watertite hub for 1/2" conduit entry is provided at each end of housing (standard) for continuous feed. Polyurethane gasketing is formed in the housing providing a continuous seamless seal for the diffuser. Four sturdy cam latches clamp diffuser tightly for a positive seal between housing, gasketing and diffuser. Electrical components and fixtures are UL/ cUL listed for Wet Locations.

Electrical

Long-Life LED system coupled with electrical driver to deliver optimal performance. LED's available in 3500, 4000 and 5000K with a CRI ≥ 85. Projected life is 60,000 hours at 91% lumen output. cULus listed. Electronic drivers are available for 120-277V applications. A 0-10V dimming control is available (standard). IP65 rated and NSF certified (4' only).

Lens

DR=Internal Prismatic Lens/15% DR High Impact Additive.
DR100=Internal Prismatic Lens/100% DR High Impact Additive.

Warranty

Vaportite LED features a five year limited warranty.

Compliance

DesignLights Consortium™ Qualified and classified for DLC Standard (some models are not DLC qualified), refer to www.designlights.org for details.



VAPORTITE LED

4' INDUSTRIAL LED LAMP

Vaportite Industrial Refrigerated Case

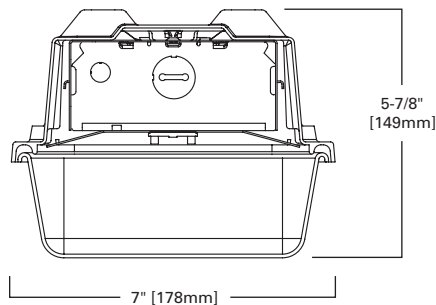

MOUNTING DATA

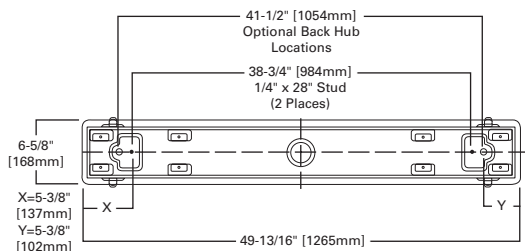

INSTALLATION DATA

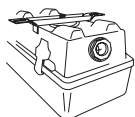

MOUNTING BRACKETS
Furnished
Two per 2' and 4' Unit
Four per 8' Unit



OPTIONAL CHAN HANGING SET
(VT2-CHAIN/SETU)
Includes 6 ft. of chain, 4 large S-Hooks and 4 small S-Hooks
Order One (1) Kit for each 2' or 4' Fixture

ENERGY DATA

Input Watts:
4VT2-LD4-4 (4,000 lumens)=38W
4VT2-LD4-6 (6,000 lumens)=57.3W
4VT2-LD4-8 (8,000 lumens)=81.1W

LINEAR DISCONNECT
Safe and convenient means of disconnecting power



PHOTOMETRICS

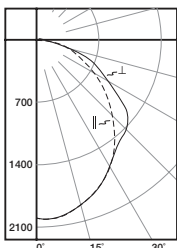

4VT2-LD4-6-DR-UNV-L835-CD1-U

Electronic Driver
 Linear LED 3500K
 Spacing criterion:
 (H) 1.2 x mounting
 height, (L) 1.2 x
 mounting height
 Lumens: 5882
 Input Watts: 56W
 Efficacy: 104.7 lm/W
 Test Report:
 4VT2-LD4-6-DR-
 UNV-L835-CD1-U.
 IES

Candlepower

Angle	Along H	45°	Across L
0	2000	2000	2000
5	2007	1979	1980
10	1981	1951	1956
15	1930	1900	1903
20	1857	1836	1844
25	1764	1748	1765
30	1645	1646	1660
35	1511	1522	1534
40	1375	1393	1468
45	1221	1271	1438
50	1062	1207	1343
55	903	1175	1148
60	749	1048	933
65	600	1151	771
70	461	591	600
75	332	398	426
80	206	249	255
85	94	137	127
90	34	75	63

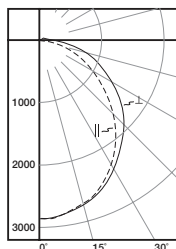

4VT2-LD4-8-FR50-UNV-L835-CD1-WL-U

Electronic Driver
 Linear LED 3500K
 Spacing criterion:
 (H) 1.2 x mounting
 height, (L) 1.3 x
 mounting height
 Lumens: 8553
 Input Watts: 81W
 Efficacy: 105.5 lm/W
 Test Report:
 4VT2-LD4-8-FR50-
 UNV-L835-CD1-WL-
 U.IES

Candlepower

Angle	Along H	45°	Across L
0	2854	2854	2854
5	2857	2829	2842
10	2811	2790	2804
15	2733	2723	2742
20	2626	2629	2658
25	2484	2508	2545
30	2316	2365	2408
35	2120	2195	2253
40	1904	2011	2086
45	1678	1819	1914
50	1451	1622	1736
55	1222	1422	1558
60	1009	1229	1368
65	810	1034	1171
70	622	843	959
75	446	659	748
80	287	487	555
85	148	341	392
90	45	228	271

Coefficients of Utilization

rc rw RCR	Effective floor cavity reflectance 20%																	
	80%			70%			50%			30%			10%			0%		
	70	50	30	70	50	30	70	50	30	70	50	30	70	50	30	0		
0	119	119	119	116	116	116	116	110	110	110	105	105	105	101	101	101	99	
1	108	103	98	94	105	101	96	93	96	93	90	92	89	87	88	86	84	82
2	98	89	82	76	95	87	81	75	84	78	73	80	75	71	77	73	70	67
3	89	78	70	63	86	76	69	62	73	67	61	70	65	60	68	63	59	56
4	81	69	60	53	79	68	59	53	65	58	52	62	56	51	60	55	50	48
5	75	62	52	46	73	60	52	45	58	51	45	56	49	44	54	48	44	41
6	69	55	46	40	67	54	46	40	52	45	39	51	44	39	49	43	38	36
7	64	50	41	35	62	49	41	35	48	40	35	46	39	34	45	38	34	32
8	59	46	37	31	58	45	37	31	44	36	31	42	35	31	41	35	30	28
9	56	42	34	28	54	41	33	28	40	33	28	39	32	28	38	32	27	25
10	52	39	31	25	51	38	31	25	37	30	25	36	30	25	35	29	25	23

Zonal Lumen Summary

Zone	Lumens	% Fixture
0-30	1536	26.1
0-40	2490	42.3
0-60	4463	75.9
0-90	5804	98.7
0-180	5882	100.0

Coefficients of Utilization

rc rw RCR	Effective floor cavity reflectance 20%																	
	80%			70%			50%			30%			10%			0%		
	70	50	30	70	50	30	70	50	30	70	50	30	70	50	30	0		
0	118	118	118	115	115	115	115	109	109	109	104	104	104	99	99	99	96	
1	107	102	97	93	104	99	95	91	94	91	87	90	87	84	85	83	81	79
2	97	88	81	75	94	86	79	74	82	76	72	78	73	69	74	71	67	65
3	88	77	69	62	85	75	68	61	72	65	60	69	63	58	66	61	57	54
4	81	68	59	53	78	67	58	52	64	57	51	61	55	50	59	53	49	46
5	74	61	52	45	72	60	51	45	57	50	44	55	48	43	53	47	42	40
6	69	55	46	39	66	54	45	39	52	44	38	50	43	38	48	42	37	35
7	64	50	41	35	62	49	41	35	47	40	34	45	39	34	44	38	33	31
8	59	46	37	31	57	45	37	31	43	36	30	42	35	30	40	34	30	28
9	55	42	34	28	54	41	33	28	40	32	27	38	32	27	37	31	27	25
10	52	39	31	25	50	38	30	25	37	30	25	36	29	25	34	29	24	23

Zonal Lumen Summary

Zone	Lumens	% Fixture
0-30	2200	25.7
0-40	3573	41.8
0-60	6232	96.4
0-90	8248	100.0
0-180	8553	100.0

LUMEN MAINTENANCE

Ambient Temperature	TM-21 Lumen Maintenance (60,000 hours)	Theoretical L70 (Hours)
25°C	> 91%	> 247,000

ORDERING INFORMATION

SAMPLE NUMBER: 4VT2-LD4-4-DR-UNV-L840-CD1-WL-U

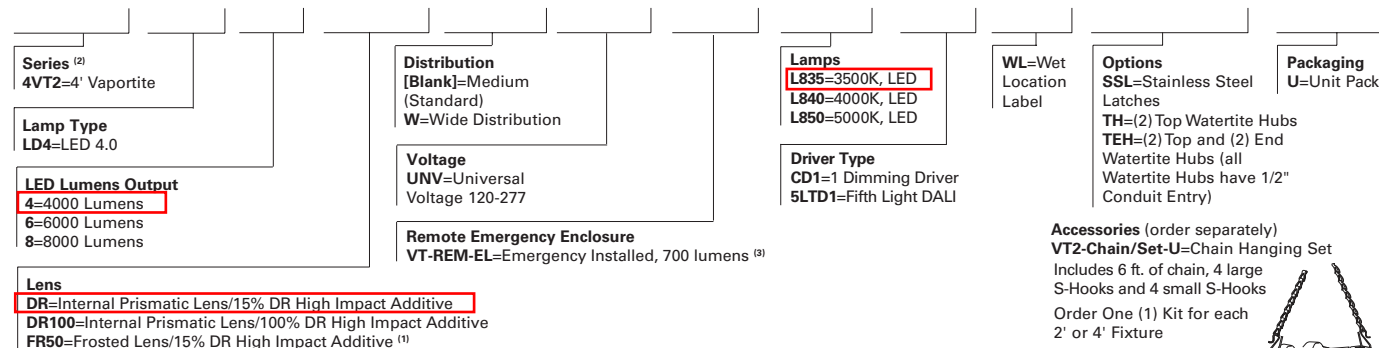

NOTES: ⁽¹⁾ Not available in wide distribution. ⁽²⁾ DesignLights Consortium™ Qualified and classified for DLC Standard (some models are not DLC qualified), refer to www.designlights.org for details. ⁽³⁾ EL must specify 120 or 277V only.

Specifications & dimensions subject to change without notice. Consult your Eaton Representative for availability and ordering information.

Accessories (order separately)
VT2-Chain/Set-U=Chain Hanging Set
 Includes 6 ft. of chain, 4 large S-Hooks and 4 small S-Hooks
 Order One (1) Kit for each 2' or 4' Fixture
VT2-SS-MBK=Stainless Steel Mounting Bracket

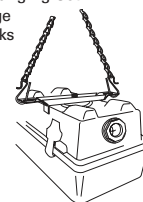

SHIPPING DATA

Catalog No.	Wt.
4VT2-LD4	18 lbs.



Photometric Report (Type C)

Filename: PG1_4VT2-LD4-4-DR-UNV-L840-CD1-U.ies
 [TEST] P131682
 [TESTLAB] INNOVATIONS CENTER-P3
 [ISSUEDATE] 11/13/14
 [MANUFAC] EATON - METALUX (FORMER COOPER LIGHTING)
 [LUMCAT] 4VT2-LD4-4-DR-UNV-L840-CD1-U
 [LUMINAIRE] METALUX 4' INDUSTRIAL VAPOR LIGHT WITH CLEAR CREPE LENS. TEST IS SCALED FROM IESNA LM-79-08 TEST DATA (P33622)

Maximum Candela = 1553.9 at 0 H 2.5 V

Classification:

Road Classification: Type VS, Very Short, N.A. (deprecated)
 Upward Waste Light Ratio: 0.01
 Luminaire Efficacy Rating (LER): 119
 Indoor Classification: Direct
 BUG Rating : B2-U2-G1

LCS Summary:

LCS Zone	Lumens	%Lamp	%Lum
FL (0-30)	591.2	N.A.	13.1
FM (30-60)	1127.2	N.A.	24.9
FH (60-80)	456.0	N.A.	10.1
FVH (80-90)	60.2	N.A.	1.3
BL (0-30)	591.2	N.A.	13.1
BM (30-60)	1127.2	N.A.	24.9
BH (60-80)	456.0	N.A.	10.1
BVH (80-90)	60.2	N.A.	1.3
UL (90-100)	40.6	N.A.	0.9
UH (100-180)	19.3	N.A.	0.4
Total	4529.1	N.A.	100.0
BUG Rating	B2-U2-G1		

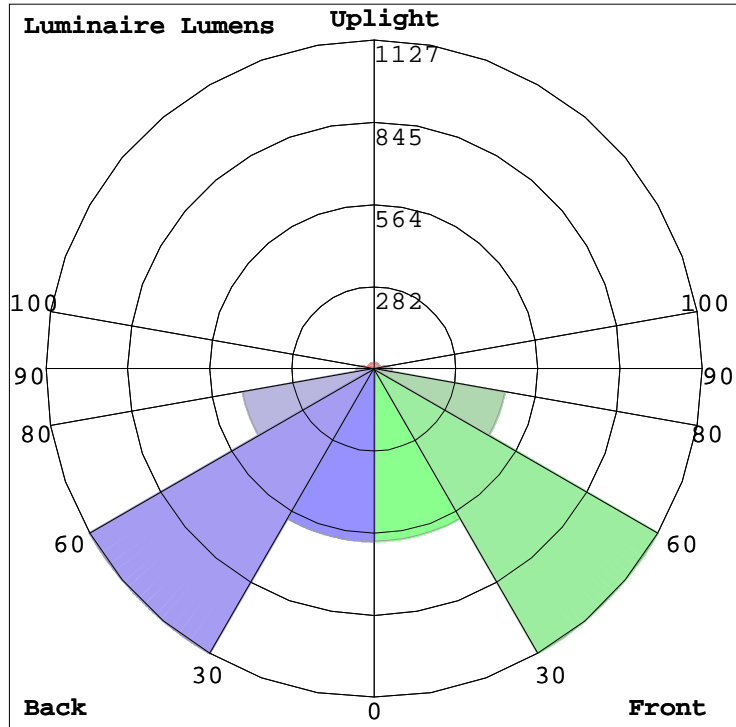

DESCRIPTION

The Galleon™ LED luminaire delivers exceptional performance in a highly scalable, low-profile design. Patented, high-efficiency AccuLED Optics™ system provides uniform and energy conscious illumination to walkways, parking lots, roadways, building areas and security lighting applications. IP66 rated and UL/cUL Listed for wet locations.

Catalog #		Type
Project		
Comments		Date
Prepared by		

SPECIFICATION FEATURES

Construction

Extruded aluminum driver enclosure thermally isolated from Light Squares for optimal thermal performance. Heavy-wall, die-cast aluminum end caps enclose housing and die-cast aluminum heat sinks. A unique, patent pending interlocking housing and heat sink provides scalability with superior structural rigidity. 3G vibration tested and rated. Optional tool-less hardware available for ease of entry into electrical chamber. Housing is IP66 rated.

Optics

Patented, high-efficiency injection-molded AccuLED Optics technology. Optics are precisely designed to shape the distribution maximizing efficiency and application spacing. AccuLED Optics create consistent distributions with the scalability to meet customized application requirements. Offered standard in 4000K (+/- 275K) CCT 70 CRI. Optional 3000K, 5000K and 6000K CCT.

Electrical

LED drivers are mounted to removable tray assembly for ease of maintenance. 120-277V 50/60Hz, 347V 60Hz or 480V 60Hz operation. 480V is compatible for use with 480V Wye systems only. Standard with 0-10V dimming. Shipped standard with Eaton proprietary circuit module designed to withstand 10kV of transient line surge. The Galleon LED luminaire is suitable for operation in -40°C to 40°C ambient environments. For applications with ambient temperatures exceeding 40°C, specify the HA (High Ambient) option. Light Squares are IP66 rated. Greater than 90% lumen maintenance expected at 60,000 hours. Available in standard 1A drive current and optional 600mA, 800mA and 1200mA drive currents (nominal).

Mounting

STANDARD ARM MOUNT: Extruded aluminum arm includes internal bolt guides allowing for easy positioning of fixture during mounting. When mounting two or more luminaires at 90° and 120° apart, the EA extended arm may be required. Refer to the

arm mounting requirement table. Round pole adapter included. For wall mounting, specify wall mount bracket option. **QUICK MOUNT ARM:** Adapter is bolted directly to the pole. Quick mount arm slide into place on the adapter and is secured via two screws, facilitating quick and easy installation. The versatile, patent pending, quick mount arm accommodates multiple drill patterns ranging from 1-1/2" to 4-7/8". Removal of the door on the quick mount arm enables wiring of the fixture without having to access the driver compartment. A knock-out enables round pole mounting.

Finish

Housing finished in super durable TGIC polyester powder coat paint, 2.5 mil nominal thickness for superior protection against fade and wear. Heat sink is powder coated black. Standard housing colors include black, bronze, grey, white, dark platinum and graphite metallic. RAL and custom color matches available.

Warranty

Five-year warranty.



GLEON GALLEON LED

1-10 Light Squares Solid State LED

AREA/SITE LUMINAIRE

DIMENSIONS

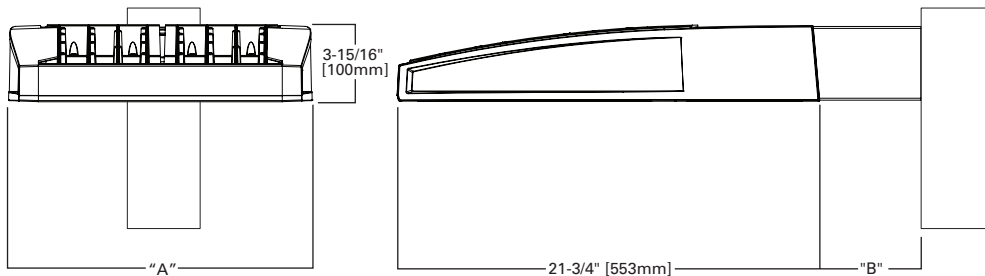

DIMENSION DATA

Number of Light Squares	"A" Width	"B" Standard Arm Length	"B" Optional Arm Length ¹	Weight with Arm (lbs.)	EPA with Arm ² (Sq. Ft.)
1-4	15-1/2" (394mm)	7" (178mm)	10" (254mm)	33 (15.0 kgs.)	0.96
5-6	21-5/8" (549mm)	7" (178mm)	10" (254mm)	44 (20.0 kgs.)	1.00
7-8	27-5/8" (702mm)	7" (178mm)	13" (330mm)	54 (24.5 kgs.)	1.07
9-10	33-3/4" (857mm)	7" (178mm)	16" (406mm)	63 (28.6 kgs.)	1.12

NOTES: 1. Optional arm length to be used when mounting two fixtures at 90° on a single pole. 2. EPA calculated with optional arm length.

DRILLING PATTERN

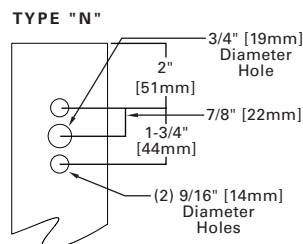

CERTIFICATION DATA

UL/cUL Wet Location Listed
ISO 9001
LM79 / LM80 Compliant
3G Vibration Rated
IP66 Rated
DesignLights Consortium™ Qualified*

ENERGY DATA

Electronic LED Driver
>0.9 Power Factor
<20% Total Harmonic Distortion
120V-277V 50/60Hz
347V & 480V 60Hz
-40°C Min. Temperature
40°C Max. Temperature
50°C Max. Temperature (HA Option)



ARM MOUNTING REQUIREMENTS

Configuration	90° Apart	120° Apart
GLEON-AF-01	7" Arm (Standard)	7" Arm (Standard)
GLEON-AF-02	7" Arm (Standard)	7" Arm (Standard)
GLEON-AF-03	7" Arm (Standard)	7" Arm (Standard)
GLEON-AF-04	7" Arm (Standard)	7" Arm (Standard)
GLEON-AF-05	10" Extended Arm (Required)	7" Arm (Standard)
GLEON-AF-06	10" Extended Arm (Required)	7" Arm (Standard)
GLEON-AF-07	13" Extended Arm (Required)	13" Extended Arm (Required)
GLEON-AF-08	13" Extended Arm (Required)	13" Extended Arm (Required)
GLEON-AF-09	16" Extended Arm (Required)	16" Extended Arm (Required)
GLEON-AF-10	16" Extended Arm (Required)	16" Extended Arm (Required)

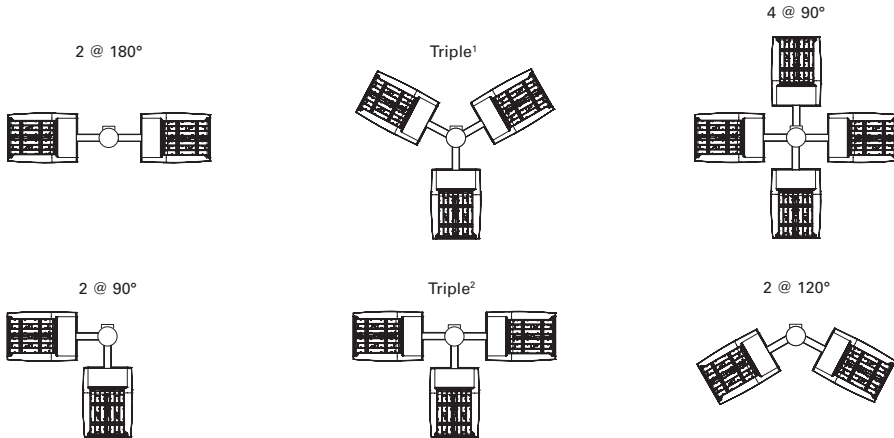

NOTES: 1 Round poles are 3 @ 120°. Square poles are 3 @ 90°. 2 Round poles are 3 @ 90°.

STANDARD WALL MOUNT

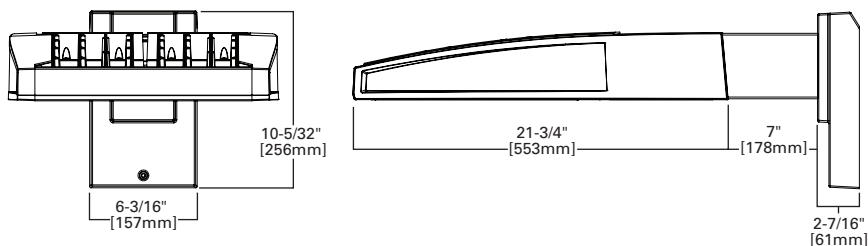

MAST ARM MOUNT

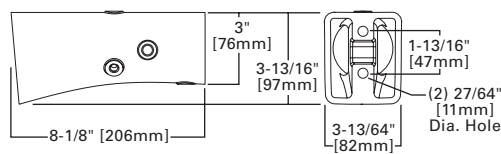

QUICK MOUNT ARM (INCLUDES FIXTURE ADAPTER)

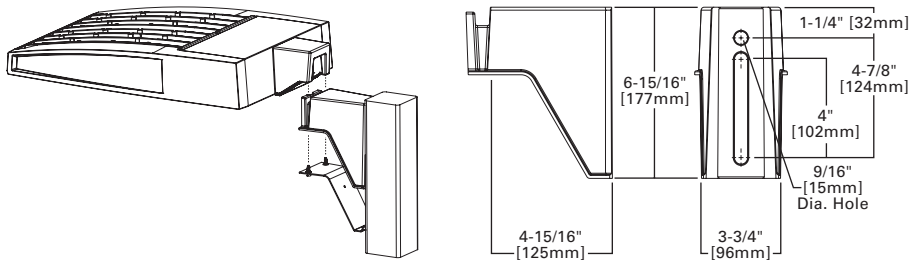

QM Quick Mount Arm (Standard)

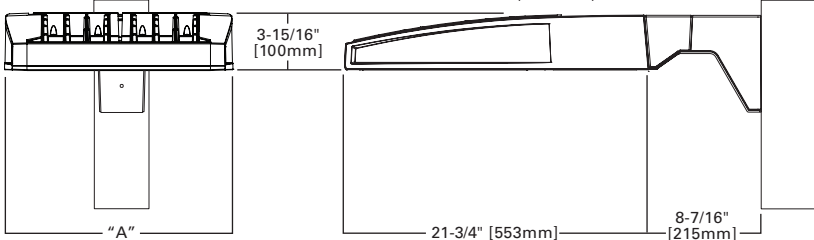

QMEA Quick Mount Arm (Extended)

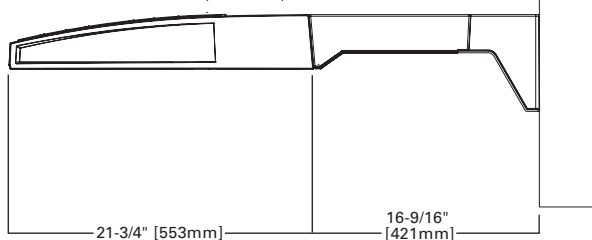

QUICK MOUNT ARM DATA

Number of Light Squares ^{1,2}	"A" Width	Weight with QM Arm (lbs.)	Weight with QMEA Arm (lbs.)	EPA (Sq. Ft.)
1-4	15-1/2" (394mm)	35 (15.91 kgs.)	38 (17.27 kgs.)	1.11
5-6 ³	21-5/8" (549mm)	46 (20.91 kgs.)	49 (22.27 kgs.)	
7-8	27-5/8" (702mm)	56 (25.45 kgs.)	59 (26.82 kgs.)	

NOTES: 1 QM option available with 1-8 light square configurations. 2 QMEA option available with 1-6 light square configurations. 3 QMEA arm to be used when mounting two fixtures at 90° on a single pole.

OPTIC ORIENTATION

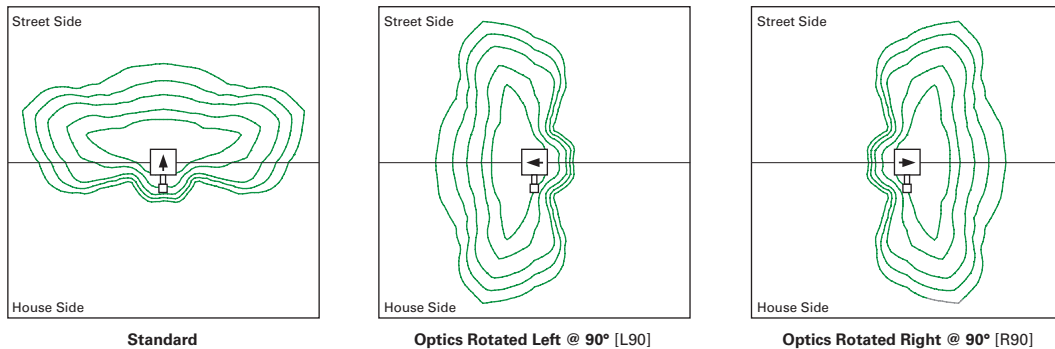

OPTICAL DISTRIBUTIONS

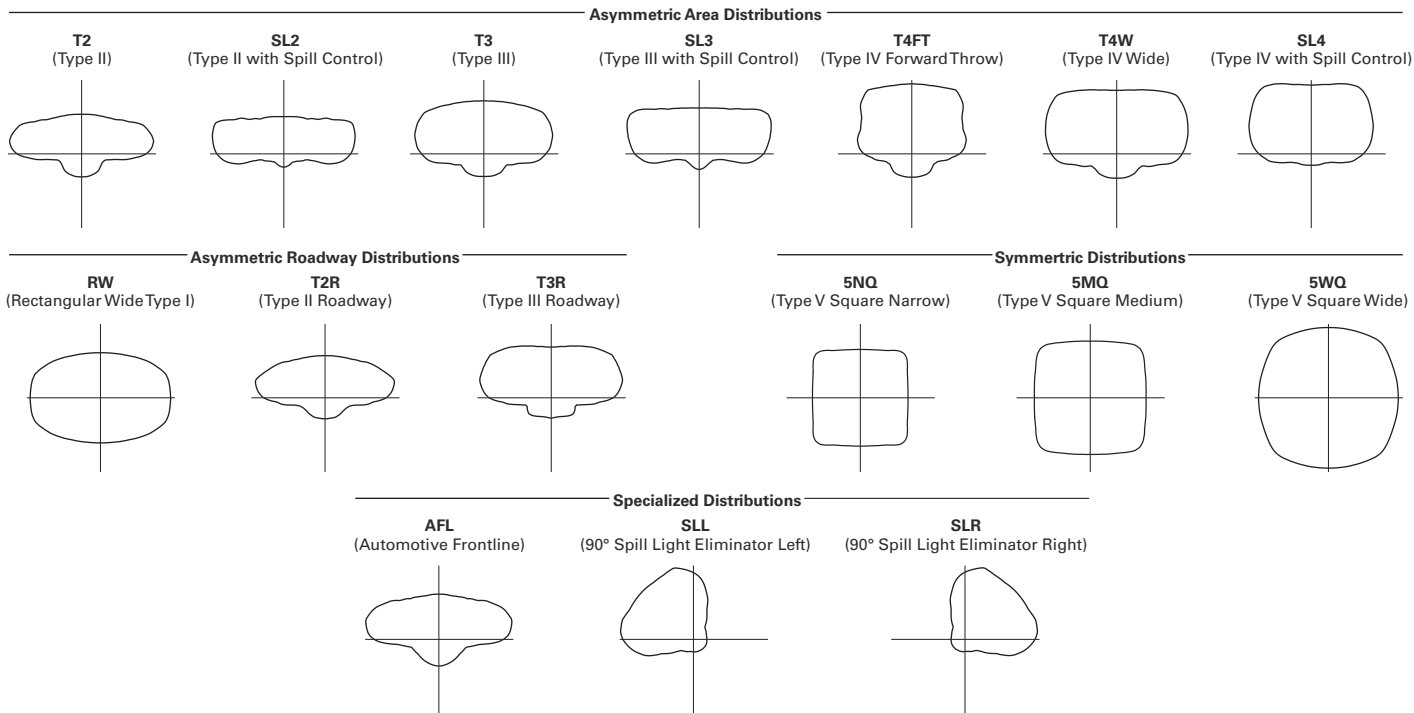

LUMEN MAINTENANCE

Drive Current	Ambient Temperature	TM-21 Lumen Maintenance (60,000 Hours)	Projected L70 (Hours)
Up to 1A	Up to 50°C	> 95%	416,000
1.2A	Up to 40°C	> 90%	205,000

LUMEN MULTIPLIER

Ambient Temperature	Lumen Multiplier
0°C	1.02
10°C	1.01
25°C	1.00
40°C	0.99
50°C	0.97

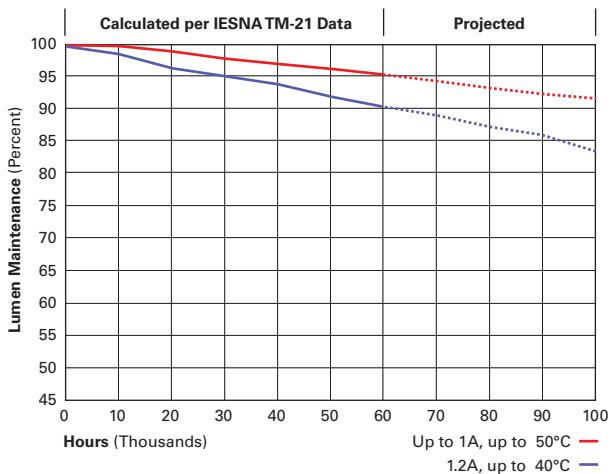



Excellence in Illumination Engineering Software since 1984



sample banner copyright 2013 Lighting Analysts, Inc.

PL1A

Photometric Report (Type C)

Filename: GLEON-AE-02-LED-E1-SL2-7030.ies
 [TEST] P126501 TEST IS SCALED FROM IESNA LM-79-08 TEST DATA (P24286)
 [TESTLAB] Innovations Center P2
 [ISSUEDATE] 2/17/2014
 [MANUFAC] EATON - MCGRAW-EDISON (FORMER COOPER LIGHTING)
 [LUMCAT] GLEON-AE-02-LED-E1-SL2-7030
 [LUMINAIRE] GALLEON LED AREA AND ROADWAY LUMINAIRE (2)
 70 CRI, 3000K, 1A LIGHTSQUARES WITH 16 LEDS EACH AND TYPE II SPILL LIGHT ELIMINATOR OPTICS

Maximum Candela = 11468.2 at 67 H 67.5 V

Classification:

Road Classification: Type II, Short, N.A. (deprecated)
 Upward Waste Light Ratio: 0.00
 Luminaire Efficacy Rating (LER): 85
 Indoor Classification: Direct
 BUG Rating : B2-U0-G2

LCS Summary:

LCS Zone	Lumens	%Lamp	%Lum
FL (0-30)	658.7	N.A.	7.3
FM (30-60)	3446.8	N.A.	38.1
FH (60-80)	3260.9	N.A.	36.0
FVH (80-90)	185.0	N.A.	2.0
BL (0-30)	415.7	N.A.	4.6
BM (30-60)	503.9	N.A.	5.6
BH (60-80)	554.7	N.A.	6.1
BVH (80-90)	25.4	N.A.	0.3
UL (90-100)	0.0	N.A.	0.0
UH (100-180)	0.0	N.A.	0.0
Total	9051.1	N.A.	100.0
BUG Rating	B2-U0-G2		

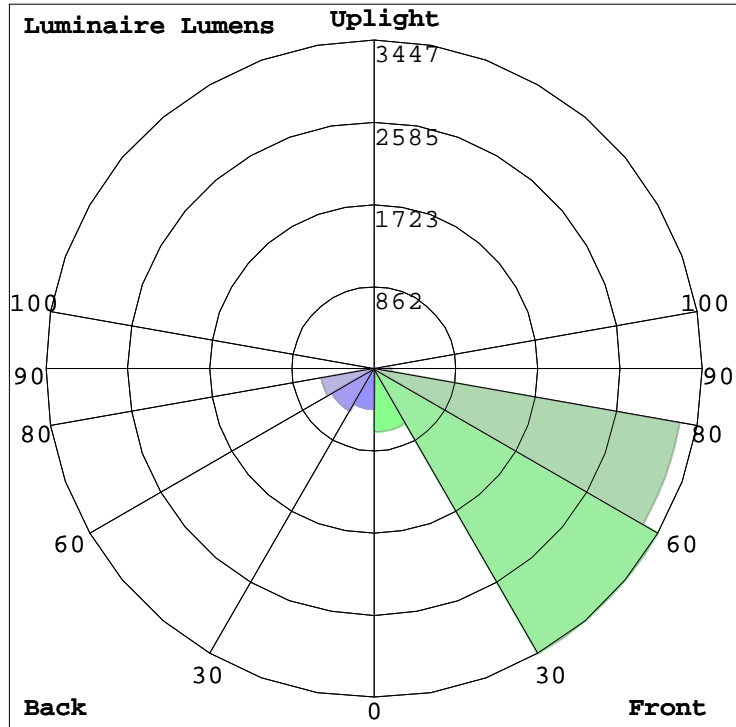



Excellence in Illumination Engineering Software since 1984



sample banner copyright 2013 Lighting Analysts, Inc.

PL1B

Photometric Report (Type C)

Filename: GLEON-AF-02-LED-E1-SL3-7030.ies
 [TEST] P192910 TEST IS SCALED FROM IESNA LM-79-08 TEST DATA (P24288)
 [TESTLAB] Innovations Center P2
 [ISSUE DATE] 7/21/2016
 [MANUFAC] EATON - MCGRAW-EDISON (FORMER COOPER LIGHTING)
 [LUMCAT] GLEON-AF-02-LED-E1-SL3-7030
 [LUMINAIRE] GALLEON AREA AND ROADWAY LUMINAIRE (2) 70 CRI, 3000K, 1050mA LIGHTSQUARES WITH 16 LEDS EACH AND TYPE III SPILL LIGHT ELIMINATOR OPTICS

Maximum Candela = 11795.4 at 60 H 69 V

Classification:

Road Classification: Type III, Medium, N.A. (deprecated)
 Upward Waste Light Ratio: 0.00
 Luminaire Efficacy Rating (LER): 95
 Indoor Classification: Direct
 BUG Rating : B2-U0-G3

LCS Summary:

LCS Zone	Lumens	%Lamp	%Lum
FL (0-30)	910.4	N.A.	8.4
FM (30-60)	3990.9	N.A.	37.0
FH (60-80)	4102.3	N.A.	38.0
FVH (80-90)	244.5	N.A.	2.3
BL (0-30)	447.5	N.A.	4.2
BM (30-60)	538.9	N.A.	5.0
BH (60-80)	521.5	N.A.	4.8
BVH (80-90)	26.0	N.A.	0.2
UL (90-100)	0.0	N.A.	0.0
UH (100-180)	0.0	N.A.	0.0
Total	10782.0	N.A.	100.0
BUG Rating	B2-U0-G3		

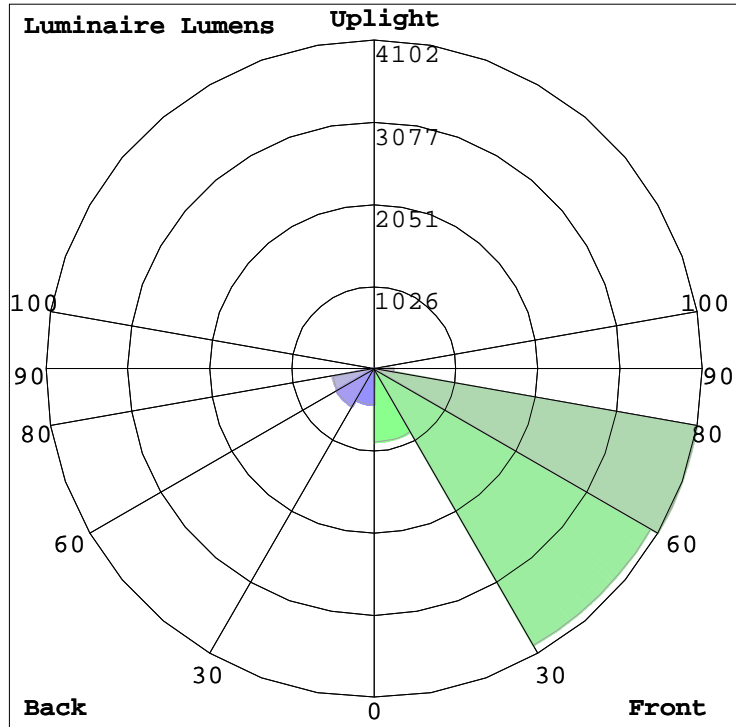



Excellence in Illumination Engineering Software
since 1984



sample banner copyright 2013 Lighting Analysts, Inc.

PL1C

Photometric Report (Type C)

Filename: PL1C_GLEON-AF-02-LED-E1-T4FT-7030.ies
 [TEST] P193270 TEST IS SCALED FROM IESNA LM-79-08 TEST
 DATA (P24295)
 [TESTLAB] Innovations Center P2
 [ISSUE DATE] 7/21/2016
 [MANUFAC] EATON - MCGRAW-EDISON (FORMER COOPER
 LIGHTING)
 [LUMCAT] GLEON-AF-02-LED-E1-T4FT-7030
 [LUMINAIRE] GALLEON AREA AND ROADWAY LUMINAIRE (2) 70
 CRI, 3000K, 1050mA LIGHTSQUARES WITH 16 LEDS EACH AND
 TYPE IV FORWARD THROW OPTICS

Maximum Candela = 9924.7 at 35 H 73 V

Classification:

Road Classification: Type IV, Short, N.A. (deprecated)
 Upward Waste Light Ratio: 0.00
 Luminaire Efficacy Rating (LER): 96
 Indoor Classification: Direct
 BUG Rating : B2-U0-G2

LCS Summary:

LCS Zone	Lumens	%Lamp	%Lum
FL (0-30)	592.5	N.A.	5.5
FM (30-60)	3628.8	N.A.	33.5
FH (60-80)	4400.9	N.A.	40.6
FVH (80-90)	154.3	N.A.	1.4
BL (0-30)	523.4	N.A.	4.8
BM (30-60)	992.6	N.A.	9.2
BH (60-80)	468.0	N.A.	4.3
BVH (80-90)	84.4	N.A.	0.8
UL (90-100)	0.0	N.A.	0.0
UH (100-180)	0.0	N.A.	0.0
Total	10844.9	N.A.	100.0
BUG Rating	B2-U0-G2		

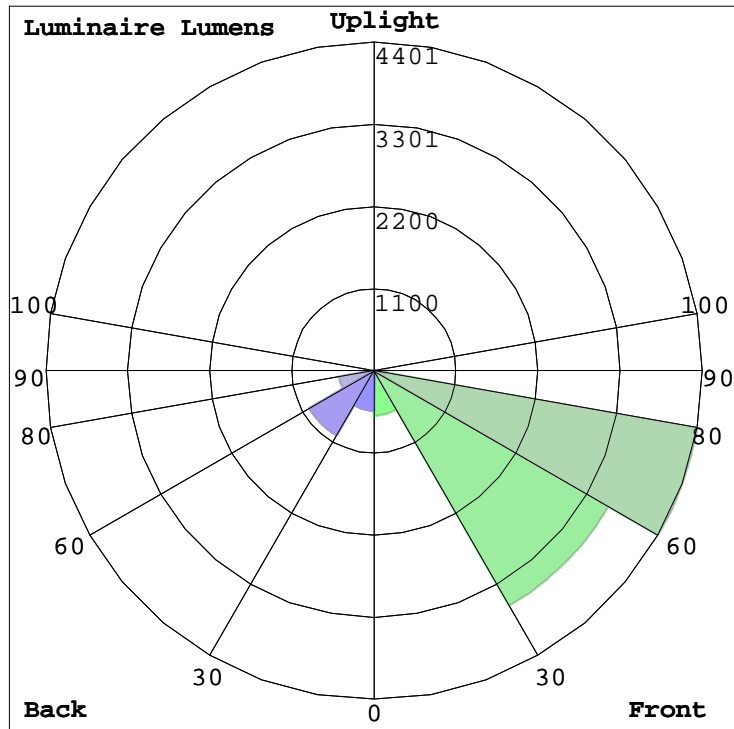



Excellence in Illumination Engineering Software
since 1984



sample banner copyright 2013 Lighting Analysts, Inc.

PL1D

Photometric Report (Type C)

Filename: GLEON-AF-02-LED-E1-5WQ-7030.ies
 [TEST] P192630 TEST IS SCALED FROM IESNA LM-79-08 TEST DATA (P24143)
 [TESTLAB] Innovations Center P2
 [ISSUE DATE] 7/21/2016
 [MANUFAC] EATON - MCGRAW-EDISON (FORMER COOPER LIGHTING)
 [LUMCAT] GLEON-AF-02-LED-E1-5WQ-7030
 [LUMINAIRE] GALLEON AREA AND ROADWAY LUMINAIRE (2) 70 CRI, 3000K, 1050mA LIGHTSQUARES WITH 16 LEDS EACH AND TYPE V WIDE OPTICS

Maximum Candela = 4547.1 at 45 H 72.5 V

Classification:

Road Classification: Type VS, Short, N.A. (deprecated)
 Upward Waste Light Ratio: 0.00
 Luminaire Efficacy Rating (LER): 100
 Indoor Classification: Direct
 BUG Rating : B4-U0-G2

LCS Summary:

LCS Zone	Lumens	%Lamp	%Lum
FL (0-30)	368.1	N.A.	3.2
FM (30-60)	2013.4	N.A.	17.7
FH (60-80)	3176.1	N.A.	28.0
FVH (80-90)	119.9	N.A.	1.1
BL (0-30)	368.1	N.A.	3.2
BM (30-60)	2013.4	N.A.	17.7
BH (60-80)	3176.1	N.A.	28.0
BVH (80-90)	119.9	N.A.	1.1
UL (90-100)	0.0	N.A.	0.0
UH (100-180)	0.0	N.A.	0.0
Total	11355.0	N.A.	100.0
BUG Rating	B4-U0-G2		

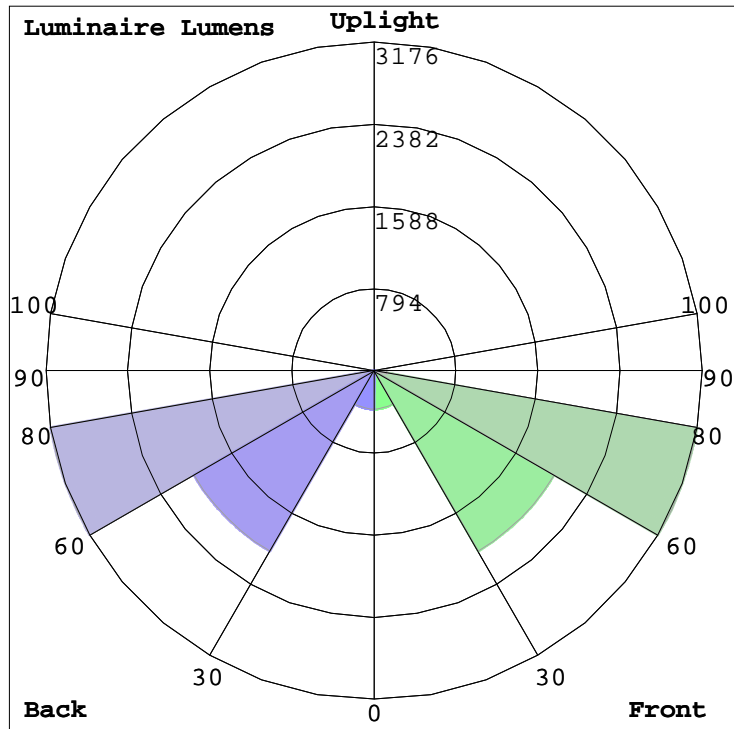



Excellence in Illumination Engineering Software since 1984



sample banner copyright 2013 Lighting Analysts, Inc.

PL2B

Photometric Report (Type C)

Filename: PL2B_GLEON-AF-01-LED-E1-SL3-7030.ies
 [TEST] P192909 TEST IS SCALED FROM IESNA LM-79-08 TEST DATA (P24288)
 [TESTLAB] Innovations Center P2
 [ISSUE DATE] 7/21/2016
 [MANUFAC] EATON - MCGRAW-EDISON (FORMER COOPER LIGHTING)
 [LUMCAT] GLEON-AF-01-LED-E1-SL3-7030
 [LUMINAIRE] GALLEON AREA AND ROADWAY LUMINAIRE (1) 70 CRI, 3000K, 1050mA LIGHTSQUARE WITH 16 LEDS EACH AND TYPE III SPILL LIGHT ELIMINATOR OPTICS

Maximum Candela = 6035.5 at 60 H 69 V

Classification:

Road Classification: Type III, Medium, N.A. (deprecated)
 Upward Waste Light Ratio: 0.00
 Luminaire Efficacy Rating (LER): 94
 Indoor Classification: Direct
 BUG Rating : B1-U0-G2

LCS Summary:

LCS Zone	Lumens	%Lamp	%Lum
FL (0-30)	465.8	N.A.	8.4
FM (30-60)	2042.1	N.A.	37.0
FH (60-80)	2099.1	N.A.	38.0
FVH (80-90)	125.1	N.A.	2.3
BL (0-30)	229.0	N.A.	4.2
BM (30-60)	275.7	N.A.	5.0
BH (60-80)	266.8	N.A.	4.8
BVH (80-90)	13.3	N.A.	0.2
UL (90-100)	0.0	N.A.	0.0
UH (100-180)	0.0	N.A.	0.0
Total	5516.9	N.A.	100.0
BUG Rating	B1-U0-G2		

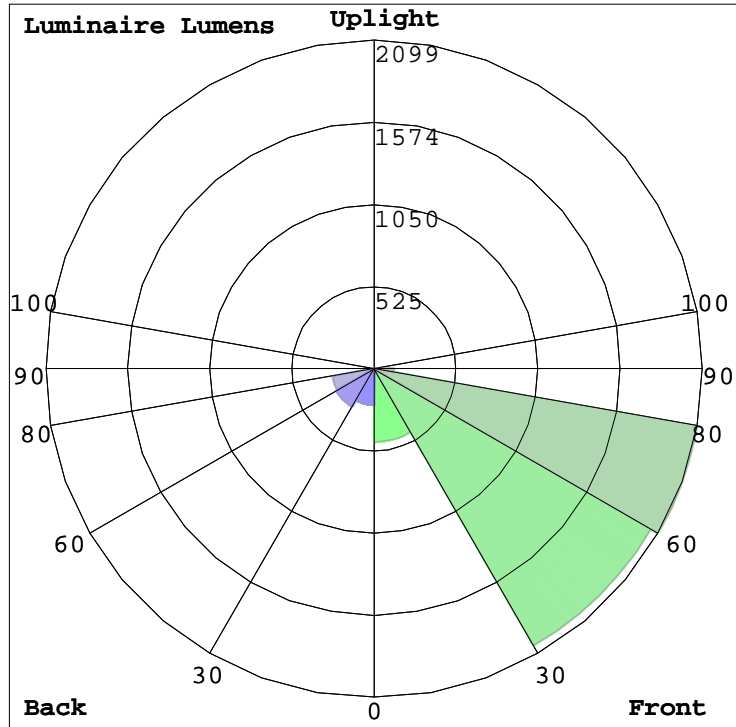



Excellence in Illumination Engineering Software
since 1984



sample banner copyright 2013 Lighting Analysts, Inc.

PL2C

Photometric Report (Type C)

Filename: PL2C_GLEON-AF-01-LED-E1-T4FT-7030.ies
 [TEST] P193269 TEST IS SCALED FROM IESNA LM-79-08 TEST
 DATA (P24295)
 [TESTLAB] Innovations Center P2
 [ISSUE DATE] 7/21/2016
 [MANUFAC] EATON - MCGRAW-EDISON (FORMER COOPER
 LIGHTING)
 [LUMCAT] GLEON-AF-01-LED-E1-T4FT-7030
 [LUMINAIRE] GALLEON AREA AND ROADWAY LUMINAIRE (1) 70
 CRI, 3000K, 1050mA LIGHTSQUARE WITH 16 LEDS EACH AND
 TYPE IV FORWARD THROW OPTICS

Maximum Candela = 5079 at 35 H 73 V

Classification:

Road Classification: Type IV, Short, N.A. (deprecated)
 Upward Waste Light Ratio: 0.00
 Luminaire Efficacy Rating (LER): 94
 Indoor Classification: Direct
 BUG Rating : B1-U0-G2

LCS Summary:

LCS Zone	Lumens	%Lamp	%Lum
FL (0-30)	303.2	N.A.	5.5
FM (30-60)	1857.1	N.A.	33.5
FH (60-80)	2252.2	N.A.	40.6
FVH (80-90)	79.0	N.A.	1.4
BL (0-30)	267.9	N.A.	4.8
BM (30-60)	508.0	N.A.	9.2
BH (60-80)	239.5	N.A.	4.3
BVH (80-90)	43.2	N.A.	0.8
UL (90-100)	0.0	N.A.	0.0
UH (100-180)	0.0	N.A.	0.0
Total	5550.1	N.A.	100.0
BUG Rating	B1-U0-G2		

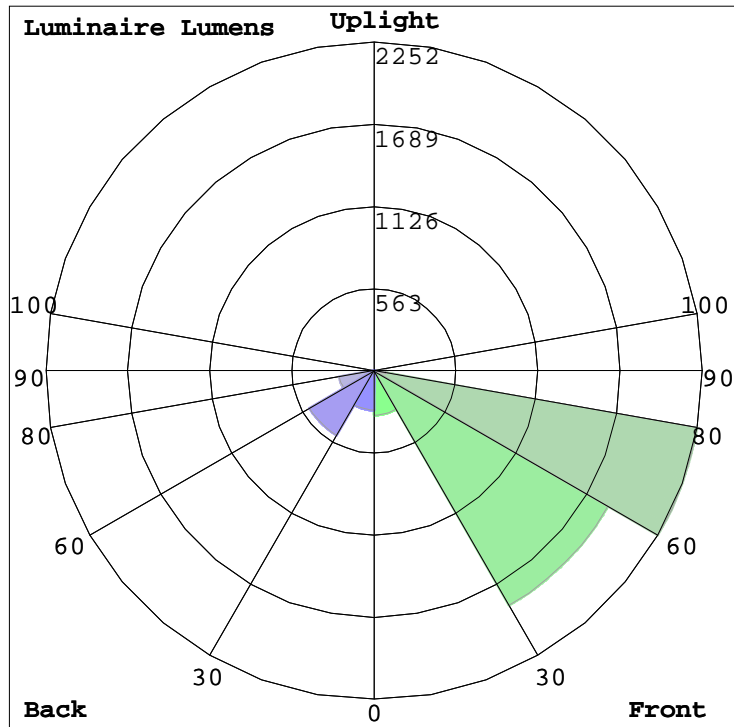



Photometric Report (Type C)

Filename: PL2CH_GLEON-AF-01-LED-E1-SL4-7030-HSS.ies
 [TEST] P192949 TEST IS SCALED FROM IESNA LM-79-08 TEST DATA (P24301)
 [TESTLAB] Innovations Center P2
 [ISSUE DATE] 7/21/2016
 [MANUFAC] EATON - MCGRAW-EDISON (FORMER COOPER LIGHTING)
 [LUMCAT] GLEON-AF-01-LED-E1-SL4-7030-HSS
 [LUMINAIRE] GALLEON AREA AND ROADWAY LUMINAIRE (1) 70 CRI, 3000K, 1050mA LIGHTSQUARE WITH 16 LEDS EACH AND TYPE IV SPILL LIGHT ELIMINATOR OPTICS WITH HOUSE SIDE SHIELD

Maximum Candela = 3679.7 at 40 H 69 V

Classification:

Road Classification: Type IV, Short, N.A. (deprecated)
 Upward Waste Light Ratio: 0.00
 Luminaire Efficacy Rating (LER): 76
 Indoor Classification: Direct
 BUG Rating : B0-U0-G2

LCS Summary:

LCS Zone	Lumens	%Lamp	%Lum
FL (0-30)	327.5	N.A.	7.3
FM (30-60)	1867.0	N.A.	41.7
FH (60-80)	1950.8	N.A.	43.6
FVH (80-90)	70.7	N.A.	1.6
BL (0-30)	84.9	N.A.	1.9
BM (30-60)	140.8	N.A.	3.1
BH (60-80)	34.0	N.A.	0.8
BVH (80-90)	2.3	N.A.	0.1
UL (90-100)	0.0	N.A.	0.0
UH (100-180)	0.0	N.A.	0.0
Total	4478.0	N.A.	100.0
BUG Rating	B0-U0-G2		

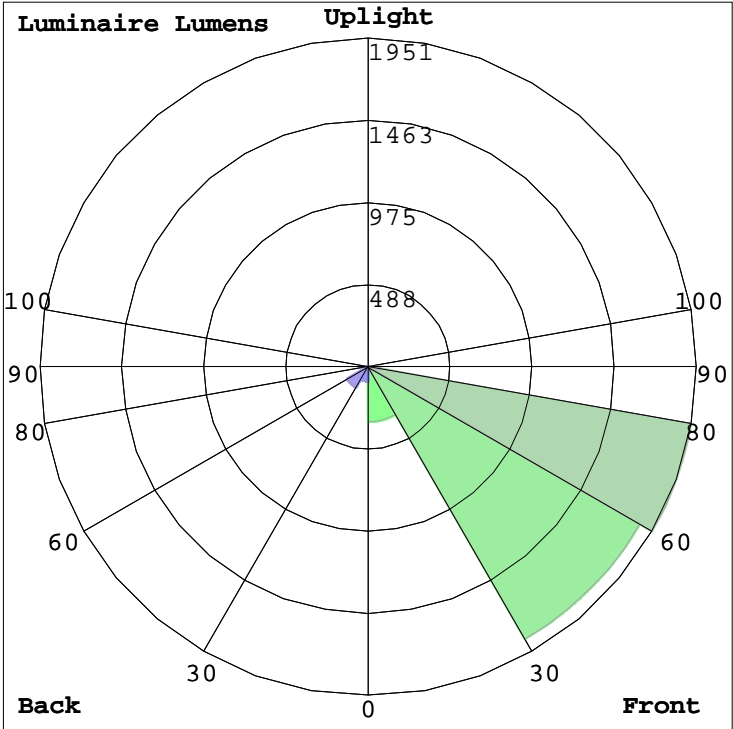



Excellence in Illumination Engineering Software
since 1984



sample banner copyright 2013 Lighting Analysts, Inc.

PL2D

Photometric Report (Type C)

Filename: PL2D_GLEON-AF-02-LED-E1-5WQ-7030.ies
 [TEST] P192630 TEST IS SCALED FROM IESNA LM-79-08 TEST DATA (P24143)
 [TESTLAB] Innovations Center P2
 [ISSUE DATE] 7/21/2016
 [MANUFAC] EATON - MCGRAW-EDISON (FORMER COOPER LIGHTING)
 [LUMCAT] GLEON-AF-02-LED-E1-5WQ-7030
 [LUMINAIRE] GALLEON AREA AND ROADWAY LUMINAIRE (2) 70 CRI, 3000K, 1050mA LIGHTSQUARES WITH 16 LEDS EACH AND TYPE V WIDE OPTICS

Maximum Candela = 4547.1 at 45 H 72.5 V

Classification:

Road Classification: Type VS, Short, N.A. (deprecated)
 Upward Waste Light Ratio: 0.00
 Luminaire Efficacy Rating (LER): 100
 Indoor Classification: Direct
 BUG Rating : B4-U0-G2

LCS Summary:

LCS Zone	Lumens	%Lamp	%Lum
FL (0-30)	368.1	N.A.	3.2
FM (30-60)	2013.4	N.A.	17.7
FH (60-80)	3176.1	N.A.	28.0
FVH (80-90)	119.9	N.A.	1.1
BL (0-30)	368.1	N.A.	3.2
BM (30-60)	2013.4	N.A.	17.7
BH (60-80)	3176.1	N.A.	28.0
BVH (80-90)	119.9	N.A.	1.1
UL (90-100)	0.0	N.A.	0.0
UH (100-180)	0.0	N.A.	0.0
Total	11355.0	N.A.	100.0
BUG Rating	B4-U0-G2		

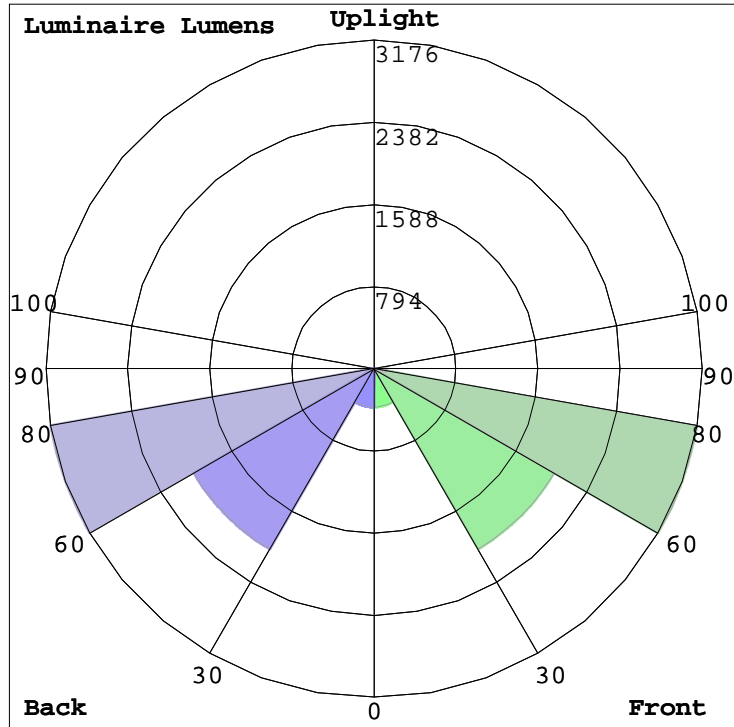

12V | Litesphere™ LED Strand

CAT: FEET:

TYPE: PROJECT:



Energy-efficient, low voltage strand lighting using wedge-base LED lamps protected by clear, frosted or colored polycarbonate globes.

Features

- Flexible 16AWG. cord available in Black or White with matching socket.
- Shatterproof, polycarbonate, O-ring fitted globes protect lamps with clarity and seamless appearance.
- Socket is parallel wired and permanently fixed to cord.
- Field cuttable.

Mounting

Each Socket has mounting holes for screw attachment in under-eave applications. Use 1/8" stainless steel wire cable (by others) and included hanger clips for festoon applications.

Applications

Ideal for indoor and outdoor applications.

Warranty

5 years



Technical Information

Lamp Spacing	6" O.C.	12" O.C.	18" O.C.	24" O.C.
*Lumens/ft (STD)	11	5.5	3.67	2.75
*Lumens/ft (HO)	30	15	10	7.5
*Watts/ft (STD)	0.17	0.085	0.057	0.0425
*Watts/ft (HO)	0.46	0.23	0.153	0.115
Lumens/watt (STD)	65.34			
*Lumens/watt (HO)	63.51			
CRI	> 80/TYP83			
LED Colors	1900°K, 2700°K, 3000°K, 3500°K, 4000°K (+/- 80°K) 3SDCM			
Rated Life	75,000 hr.			
Ordering Increment	1'			
Operating Voltage	12V DC			
Power Supply	Class 2			
Dimming	Yes			

* 3000°K Sample

Profile Dimensions

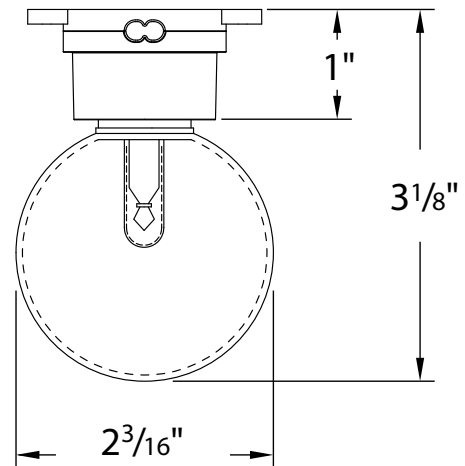



Excellence in Illumination Engineering Software
since 1984



sample banner copyright 2013 Lighting Analysts, Inc.

S - STRING
LIGHTS

Photometric Report (Type C)

Filename: S1_TIVOLI_LSLB06S39C12.ies

[TEST] BSR1604200101-9

[ISSUE DATE] 2016-4-20

[MANUFAC] TIVOLI,LLC

[LUMCAT] LSLB06S39C12

[LUMINAIRE] Litesphere

[LAMP] unidentified

Maximum Candela = 12.14 at 270 H 15 V

Classification:

Road Classification: Type VS, Very Short, Non-Cutoff (deprecated)

Upward Wast Light Ratio: 0.12

Luminaire Efficacy Rating (LER): 65

Indoor Classification: Semi-Direct

BUG Rating : B0-U1-G0

Polar Candela Curves:

Vertical Plane Through:

1) 270 - 90 Horizontal

Horizontal Cone Through:

2) 15 Vertical

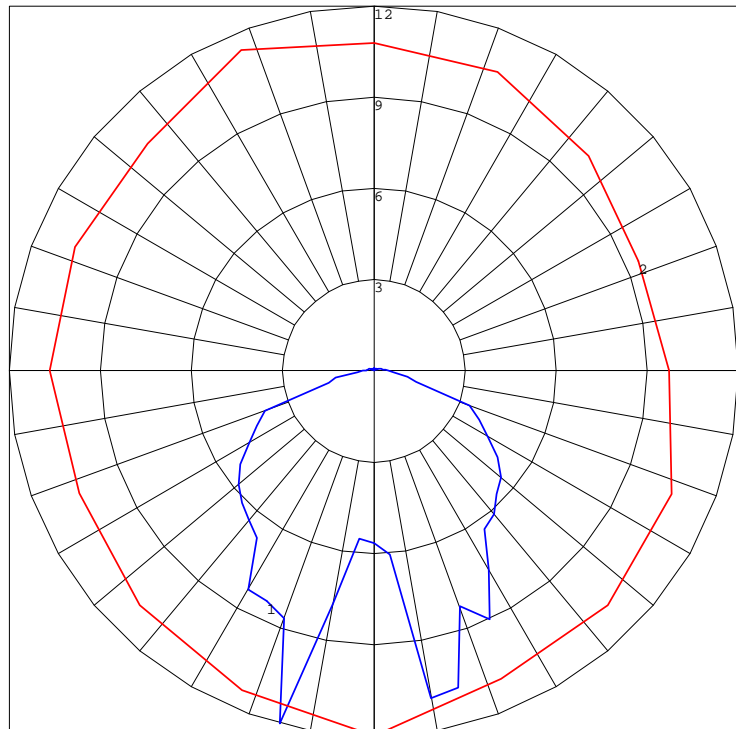



Excellence in Illumination Engineering Software
since 1984



sample banner copyright 2013 Lighting Analysts, Inc.

S - STRING
LIGHTS

Photometric Report (Type C)

Filename: S1_TIVOLI_LSLB06S39C12.ies
[TEST] BSR1604200101-9
[ISSUEDATE] 2016-4-20
[MANUFAC] TIVOLI,LLC
[LUMCAT] LSLB06S39C12
[LUMINAIRE] Litesphere
[LAMP] unidentified

Maximum Candela = 12.14 at 270 H 15 V

Classification:

Road Classification: Type VS, Very Short, Non-Cutoff (deprecated)
Upward Waste Light Ratio: 0.12
Luminaire Efficacy Rating (LER): 65
Indoor Classification: Semi-Direct
BUG Rating : B0-U1-G0

LCS Summary:

LCS Zone	Lumens	%Lamp	%Lum
FL (0-30)	3.7	11.1	11.1
FM (30-60)	6.5	19.5	19.5
FH (60-80)	3.1	9.4	9.4
FVH (80-90)	0.9	2.7	2.7
BL (0-30)	3.7	11.1	11.1
BM (30-60)	6.9	20.7	20.7
BH (60-80)	3.5	10.6	10.6
BVH (80-90)	1.0	3.0	3.0
UL (90-100)	1.4	4.1	4.1
UH (100-180)	2.6	7.9	7.9
Total	33.3	100.1	100.0
BUG Rating	B0-U1-G0		

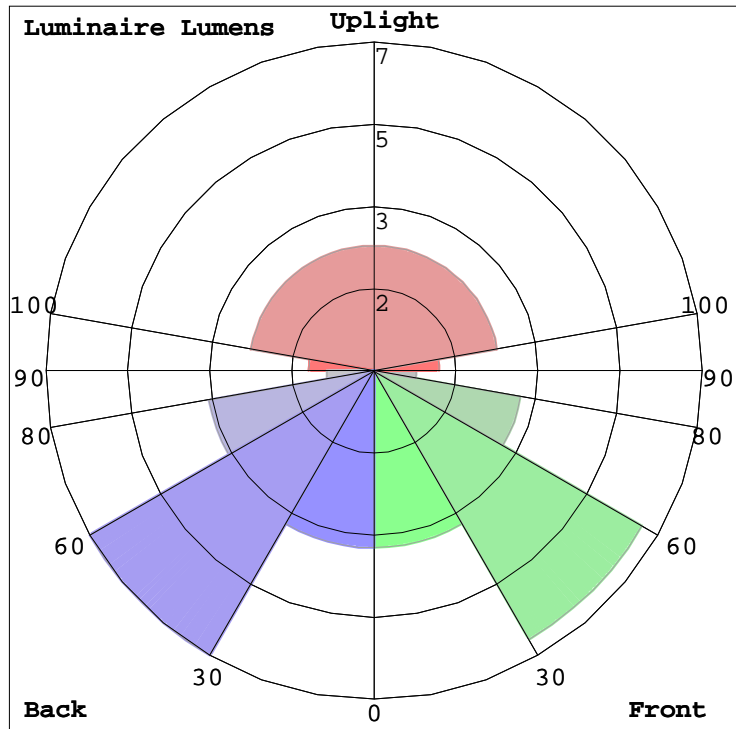



Date:		Approved:
Type:	SL1	
Fixture:		
Project:		

FCSL550 Series

Exterior Die-Cast Mini Step Light with Die-Cast or 316 Stainless Steel Faceplate.



ORDERING



75 pcs or Less / ships in 2 weeks

EXAMPLE: FC SL550-120V-4K-95-SL

SERIES	VOLTAGE	SOURCE/TEMPERATURE/LAMP	FINISH	ACCESSORIES
FC SL550	120V	LED 3K 95 Lumens min (2W)	BK Black	EC E-Coat (on SL550 only)
FC SL552	277V	4K 190 Lumens min (3W)	BZ Bronze	
FC SL553	347V [△]		CC Custom Color	
			SL Silver	
			WH White	
			SS Stainless Steel [▲]	

[△] contact factory

[▲] SL552 & SL553 only

SPECIFICATION

MOUNTING

- Concrete pour standard.

CONSTRUCTION

- Marine grade, corrosion resistant, heavy walled, high pressure die-cast aluminum construction.
- Clear (FC SL550) or opal, tempered lens.
- 316 stainless steel (FC SL552, FC SL553 - opal lens standard).
- Precision formed semi-specular aluminum reflector.
- Neoprene continuous closed cell urethane 'O' ring gasket. Captive stainless steel, tamper resistant hex socket screws.

LED

- Lumens stated are the minimum delivered out of the luminaire. LED lifetime is greater than or equal to 70,000 hours with the lumen depreciation greater than L70. All of our luminaires are tested to LM 80 with a minimum CRI of 80 and color consistency of step 4 MacAdam Ellipse. Integral power supply standard. Input voltage 120V or 277V. Consult factory for non-white static color LED options; Red, Green, Blue or Amber.

FINISH

- Six stage chemical pre-treatment process that includes iron phosphate, to prepare the substrate for a UV stable, super durable standard polyester powder coat. Optional e-coat process is added to the standard finish including zinc phosphate for a 5 year limited warranty on the finish. Brushed 316 stainless steel faceplate (FC SL552, FC SL553 only).

ELECTRICAL

- **Ballast** UL listed electronic driver standard with 5 year manufacturers warranty.

LISTING

- UL & cUL listed for interior and exterior wet locations. IP65 rating.



Excellence in Illumination Engineering Software
since 1984



sample banner copyright 2013 Lighting Analysts, Inc.

SL1

Photometric Report (Type C)

Filename: SL1_FCSSL550-LED.IES
[ISSUEDATE] 6-5-2009
[MANUFAC] FC LIGHTING
[LUMCAT] FCSSL550 LED-5W
[LUMINAIRE] FCSSL550 STEP LIGHT

Maximum Candela = 81.647998175025 at 0 H 45 V

Classification:

Road Classification: Type II, Very Short, Cutoff (deprecated)
Upward Waste Light Ratio: 0.01
Luminaire Efficacy Rating (LER): 7
Indoor Classification: Direct
BUG Rating : B0-U1-G0

LCS Summary:

LCS Zone	Lumens	%Lamp	%Lum
FL (0-30)	5.7	2.4	12.9
FM (30-60)	29.0	12.1	65.3
FH (60-80)	8.4	3.5	18.9
FVH (80-90)	0.7	0.3	1.7
BL (0-30)	< 0.05	0.0	0.0
BM (30-60)	< 0.05	0.0	0.0
BH (60-80)	< 0.05	0.0	0.0
BVH (80-90)	< 0.05	0.0	0.0
UL (90-100)	0.2	0.1	0.4
UH (100-180)	0.4	0.2	0.8
Total	44.4	18.6	100.0
BUG Rating	B0-U1-G0		

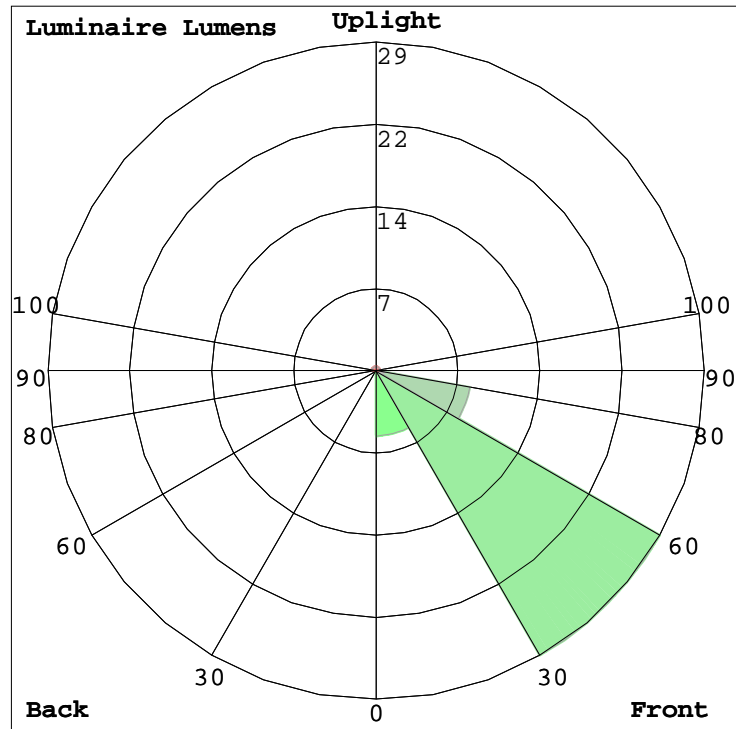

JOB NAME _____

Type _____

CATALOG NUMBER _____

Steplites **SL2**

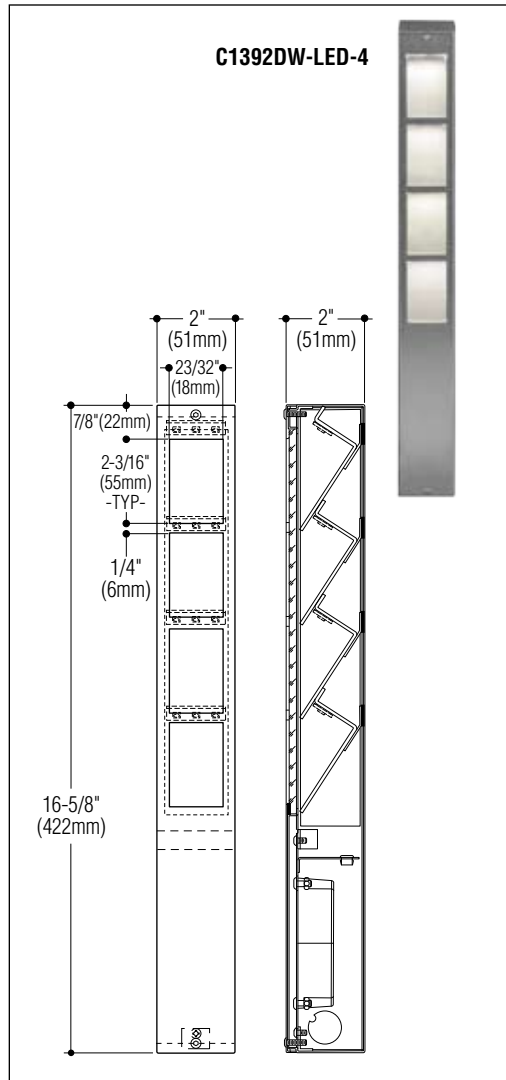
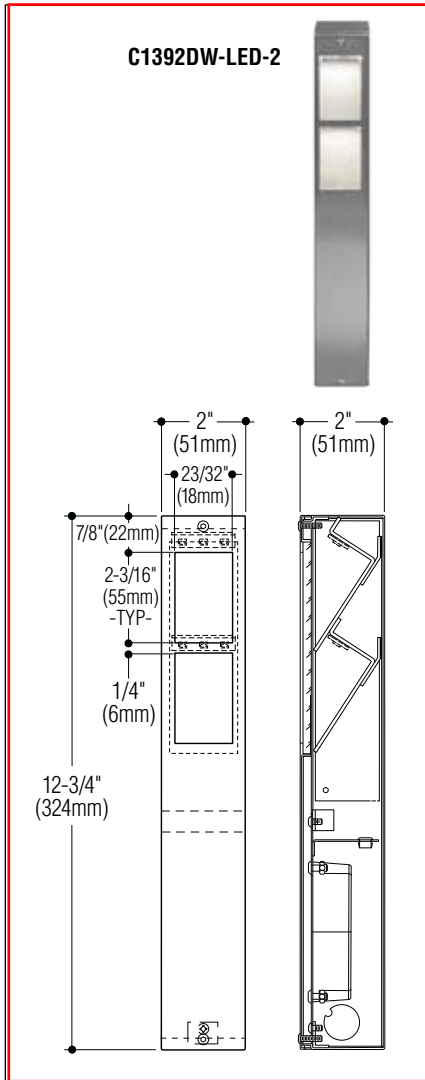

C1392D SERIES Railite

SPECIFICATIONS

Construction

- Housing is constructed from 20 gauge stainless steel or .050" aluminum
- Satin finish with passivation on exterior stainless steel surfaces or powder coat on aluminum surfaces
- Diffuser is 1/8" clear tempered glass
- Tamperproof screws provided
- cETLus listed for use in wet locations, in any wall construction
- Intended for mounting between pairs of vertical support posts via field-drilled mounting holes. Other mounting methods are available on request.

Electrical

- Fixture is wired for high performance LEDs
- Driver is universal voltage
- Provided with 1/2" knockout on either side

Mounting

Intended for mounting between pairs of vertical support posts via field-drilled mounting holes. Other mounting methods are available on request.

How to Specify

Select catalog number and add suffix(s) for desired options.

Catalog Number Lamp		Housing W & D	Housing Length	*OPTIONAL 1/2" KO'S AT BOTTOM
LED 1.5W, (126 lm @ 3000°K)	<input type="checkbox"/> C1392DW-LED-2	<input type="checkbox"/> 2" x 2"	<input type="checkbox"/> 12 3/4"	<input type="checkbox"/> 1
LED 3.6W, (215 lm @ 3000°K)	<input type="checkbox"/> C1392DW-LED-2-HO	<input type="checkbox"/> 2" x 2"	<input type="checkbox"/> 12 3/4"	<input type="checkbox"/> 1
LED 3.0W, (252 lm @ 3000°K)	<input type="checkbox"/> C1392DW-LED-4	<input type="checkbox"/> 2" x 2"	<input type="checkbox"/> 16 5/8"	<input type="checkbox"/> 1
LED 7.2W, (430 lm @ 3000°K)	<input type="checkbox"/> C1392DW-LED-4-HO	<input type="checkbox"/> 2" x 2"	<input type="checkbox"/> 16 5/8"	<input type="checkbox"/> 1

*Optional 1/2" KO's at bottom assumes standard locknuts and side by side spacing

Options

Alternate housing dimensions:

Add suffix -SP/ _____
(dimensions).

Alternate shielding: Contact factory for options.

Add suffix -OS.

Painted finish: Add suffix -CC/ _____
(color).

Frosted glass diffuser: Tempered. Add suffix -FG

LED color: 4000°. Add suffix -4K

Tamperproof screws: Socket head faceplate screws.

Add suffix -TP

Bottom knockout: 1/2" knockout at bottom in lieu of standard side knockouts (3" wide housing suitable for two knockouts). Add suffix -BKO



C.W. Cole & Company, Inc.
2560 N. Rosemead Boulevard
South El Monte, CA 91733-1593

Tel. (626) 443-2473
Fax (626) 443-9253
info@colelighting.com
www.colelighting.com



Excellence in Illumination Engineering Software
since 1984



sample banner copyright 2013 Lighting Analysts, Inc.

SL2

Photometric Report (Type C)

Filename: SL2_COLE 1392D_L11136307.IES
 [TEST] L11136307
 [TESTLAB] LIGHT LABORATORY, INC.
 [ISSUEDATE] 12/05/2013
 [MANUFAC] C.W. COLE & CO., INC.
 [LUMCAT] C1392D-LED-2
 [LUMINAIRE] 12-3/4"L. X 2"W. X 2"H. LED FIXTURE CLEAR
 LENS
 [LAMPCAT] N/A
 [BALLAST] INPUT: 100-277VAC, 50/60HZ, 0.15A OUTPUT:
 12VDC, 250-1000mA

Maximum Candela = 33.04 at 0 H 45 V

Classification:

Road Classification: Type IV, Very Short, N.A. (deprecated)
 Upward Waste Light Ratio: 0.00
 Luminaire Efficacy Rating (LER): 10
 Indoor Classification: Direct
 BUG Rating : B0-U0-G0

LCS Summary:

LCS Zone	Lumens	%Lamp	%Lum
FL (0-30)	3.8	N.A.	14.6
FM (30-60)	16.6	N.A.	63.3
FH (60-80)	5.3	N.A.	20.0
FVH (80-90)	0.0	N.A.	0.0
BL (0-30)	0.2	N.A.	0.8
BM (30-60)	0.2	N.A.	0.8
BH (60-80)	0.1	N.A.	0.5
BVH (80-90)	0.0	N.A.	0.0
UL (90-100)	0.0	N.A.	0.0
UH (100-180)	0.0	N.A.	0.0
Total	26.2	N.A.	100.0
BUG Rating	B0-U0-G0		

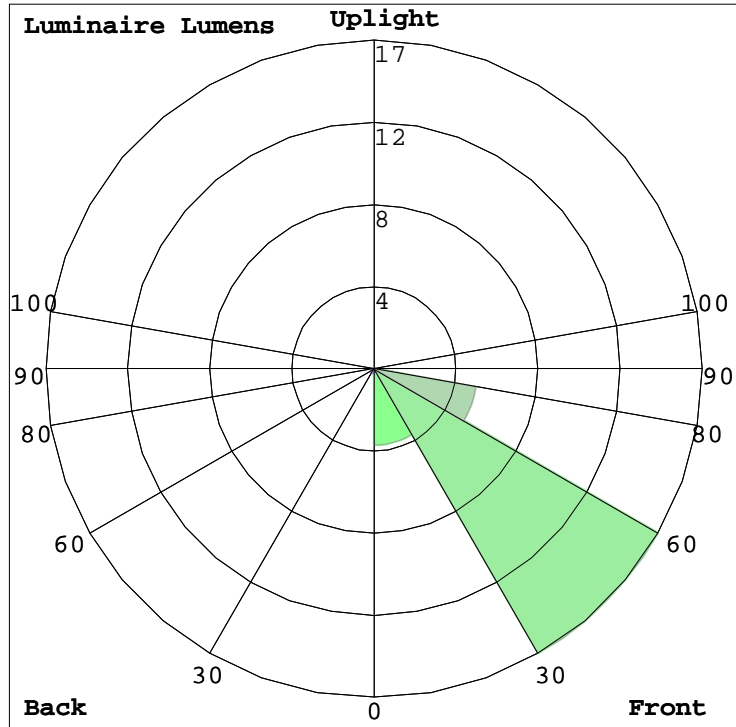

DESCRIPTION

The ASYX 2.0 second generation of asymmetric lighting is designed for general ambient illumination and accenting architectural features. The luminaire allows for both forward and wide distributions as well four different color temperatures to accommodate any space. The ASYX 2.0 utilizes the patented and highly efficient AccuLED Optics™ system for industry leading performance. IP66 rated and optional natorium finish.

Catalog #		Type
Project		
Comments		Date
Prepared by		

SPECIFICATION FEATURES

Construction

Heavy-wall die cast aluminum end caps with extruded aluminum housing. Housing fins allow for air flow and thermal management. Fixture is rated to 40°C. Weight: 12 lbs

Electrical

Standard drivers feature electronic universal voltage (120-277V/ 50-60 Hz), greater than 0.9 power factor, less than 20% harmonic distortion, and ambient temperature range of 40°C (104°F) to minimum starting temp of -30°C (-22°F). 0-10V dimming standard with DALI option available. Max amp draw @120V is 1.5 Amps.

LED Optics

ASYX 2.0 luminaire utilizes patented, high efficiency AccuLED Optics with specific optical distributions. Each lens is injection molded for precision, arranged and sealed onto a board substrate. LEDs are industry leading high output with standard product at 93% lumen maintenance at 60,000 hours. Offered in 80+ CRI for 2700K, 3000K, and 3500K

CCT, and 70+ CRI for 4000K CCT. The ASYX 2.0 also offers +/- 90°, or 180° rotated optics.

Mounting

Die cast adjustable knuckle, bolts to housing. Fixture mounts to recessed junction box (by others) using wall plate, or surface mount box with conduit entry option. Fixture has continuous adjustability, 20° up to 20° down with locking mechanism, as well as upward facing or downward facing.

Finish

Fixture housing is coated using electrostatically charged polyester powder coat paint for superior protection against fade and wear. Mounting plate and all accessories to match specified color of luminaire housing. Standard colors include white, silver, black, bronze, and custom RAL color match available.

Compliance

Components are UL recognized and luminaires are cULus listed for 40°C

ambient environments, wet location listed, and RoHS compliant. IP66 Rated.

Environment

Suited for indoor, outdoor (wet location listed, IP66 rated)

Natorium

Construction consists of specialized protective coating on all metal components, stainless steel hardware, and sealed LEDs. 80% lumen maintenance at 60,000 hours. Salt Fog testing per ASTM B117-73.

Control

Standard offering is 0-10V dimming and energy saving integral sensor device available. 0-10V dimming current draw is 0.2 mA per driver. Digital Addressable Lighting Interface (DALI) driver option can be used with Fifth Light Technology.

Life and Warranty

Standard five-year limited warranty on all parts.



ASYX-WM S1

LED

Wall Mount
Asymmetric Direct
Asymmetric Indirect

CERTIFICATION DATA
UL/cUL Wet Location Listed
LM79 / LM80 Compliant
IP66 Rated

ENERGY DATA
>0.9 Power Factor
<20% Total Harmonic Distortion
120V - 277V 50/60 Hz
-30°C Min Temperature
40°C Max Temperature

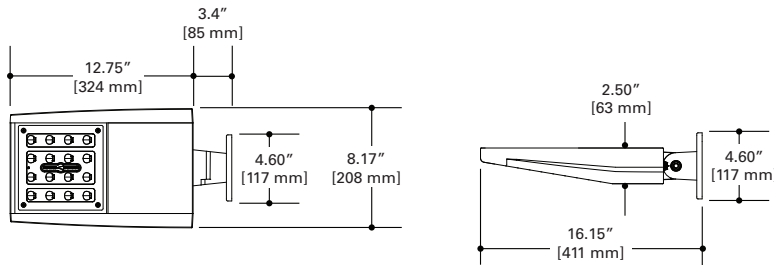

ORDERING INFORMATION

Sample Number: ASYX-WM-S1-ID-U-F-L35-1-UNV-W-R-STD-SV-R90

Series ⁽²⁾	Mounting	Size	Light Level	Environment	Orientation ⁽¹⁾	Distribution	Color Temperature	# of Circuits
ASYX = Asymmetric LED Luminaire	WM = Wall Mount	S = Small	1 = 1 Light Square (see Color Temp for CCT, lumen output, and wattage)	ID = Indoor OD = Outdoor NT = Natorium	U = Uplight D = Downlight	F = Forward Throw W = Wide Throw	L27 = 3805 lumens 55 watts forward throw L30 = 4003 lumens 55 watts forward throw L35 = 4200 lumens 55 watts forward throw L40 = 4740 lumens 55 watts forward throw <hr/> L27 = 3851 lumens 55 watts wide throw L30 = 4051 lumens 55 watts wide throw L35 = 4251 lumens 55 watts wide throw L40 = 4797 lumens 55 watts wide throw	1
Input Voltage	Finish	Mounting Surface	Extension Length ⁽³⁾ (Optional)	Driver Options	Integral Control ⁽¹⁾ (Optional)	Optical Orientation (Optional)	Options (Optional)	Accessories ⁽⁴⁾ (Optional)
UNV	W = White S = Silver B = Black Z = Bronze C = Custom Color	R = Mounting Plate (recessed j-box) C = Canopy Box (surface j-box)	12 = 12" Stem Length 18 = 18" Stem Length 24 = 24" Stem Length 30 = 30" Stem Length 36 = 36" Arm Length - Custom Length (specify to the inch between 10" to 36")	STD = Standard 0-10V 5LT-DAC = Fifth Light DALI DAC	SV = Integral Occupancy Sensor/Day light Sensor	R90 = Optics Rotated 90° right from standard L90 = Optics Rotated 90° left from standard 180 = Optics Rotated 180° from standard	RM = Rigid Fixed Knuckle FM = Flush Mount	ISHH-01-A = Programming Remote for integrated sensor ISHH-02-A = Personal Control Remote for integrated sensor

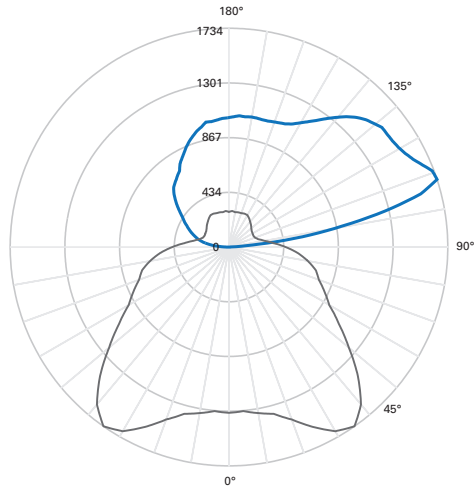

Vertical Distribution through peak candela

Horizontal Distribution through peak candela

FILE NAME: ASYX-S-1-F-X-X-L40-1-STD-UNV

LAMP: 4000K LEDs

LUMENS: 4740

INPUT WATTS: 54.7 W

EFFICACY: 86.7 LPW

TEST REPORT: P166562

ZONAL LUMEN SUMMARY

Zone	Lumens	% Fixture
90°-100°	151.5	3.2
100°-110°	637	13.4
110°-120°	867.3	18.3
120°-130°	851.4	18.0
130°-140°	770.4	16.3
140°-150°	620.6	13.1
150°-160°	457.7	9.7
160°-170°	286.5	6.0
170°-180°	97.6	2.1
0°-180°	4739.8	100

LUMEN MAINTENANCE

Ambient Temperature	TM-21 Lumen Maintenance (60,000 Hours)	Theoretical L90 (Hours)
25°C	> 96%	130,000
35°C	> 93%	91,000
40°C	> 95%	117,000

DISTRIBUTION

F - Forward Throw Distribution

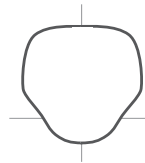

W - Wide Throw Distribution

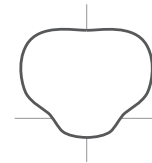

MOUNTING AND AIMING

R - Recessed junction box option: 8.4" x 5" wall plate mounts to standard junction box.

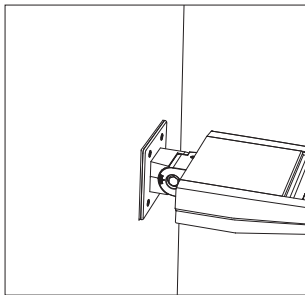

C - Conduit Entry option: Surface metal box fits over standard junction box with conduit entry option on all sides.

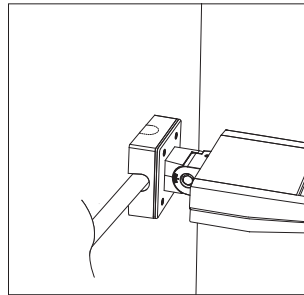

Mounting Plate

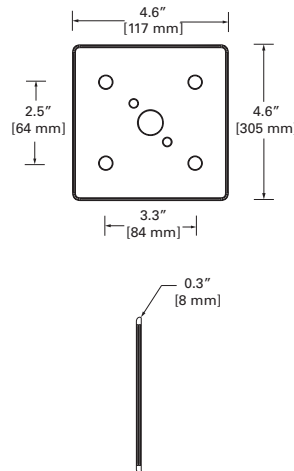

The ASYX 2.0 features +/-20° adjustable aiming as standard

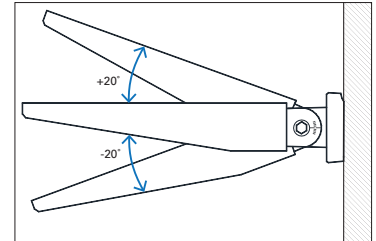

REFERENCE

ASYX 2.0 SUMMARY TABLE

PRODUCT NAME:	SL	S1	S2	S3	S4	L3	L4	L5	L6
NUMBER OF LIGHT SQUARES:	1	1	2	3	4	3	4	5	6
LUMENS:	2970	4797	9812	14745	19761	15304	19929	25565	30162
WATTAGE:	27.5	55	107	158	214	158	214	268	319
LPW:	108	87	92	93	92	97	93	95	95
HID EQUIVALENT:	39W	70W	150W	250W	320W	250W	320W	400W	2 x 250W

Note: Based on 4000K, Wide Throw Distribution

CONTROL

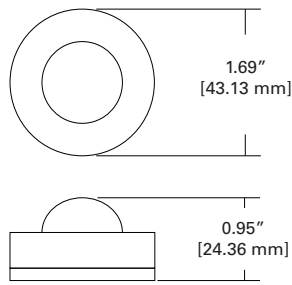
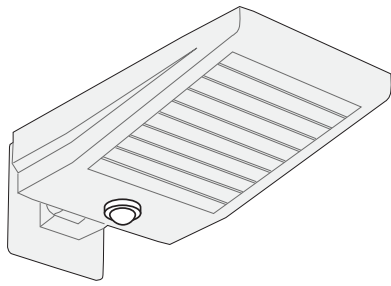

SV - The integral sensor is a fully integrated sensor with no additional wiring or special installation required. Passive infrared occupancy detection is the technology used and the light sensor uses a closed-loop daylight harvester with day, twilight and night settings. Energy Saver setting dims to a lower light level when unoccupied. An infrared receiver is used for programming with a remote control. Indicator light is used for occupancy status and programming confirmation. Integral sensor only controls one fixture unit.

ISHH-01-A - Programming Remote for Integrated Sensor
ISHH-02-A - Personal Control Remote for Integrated Sensor

OPTIC ORIENTATION

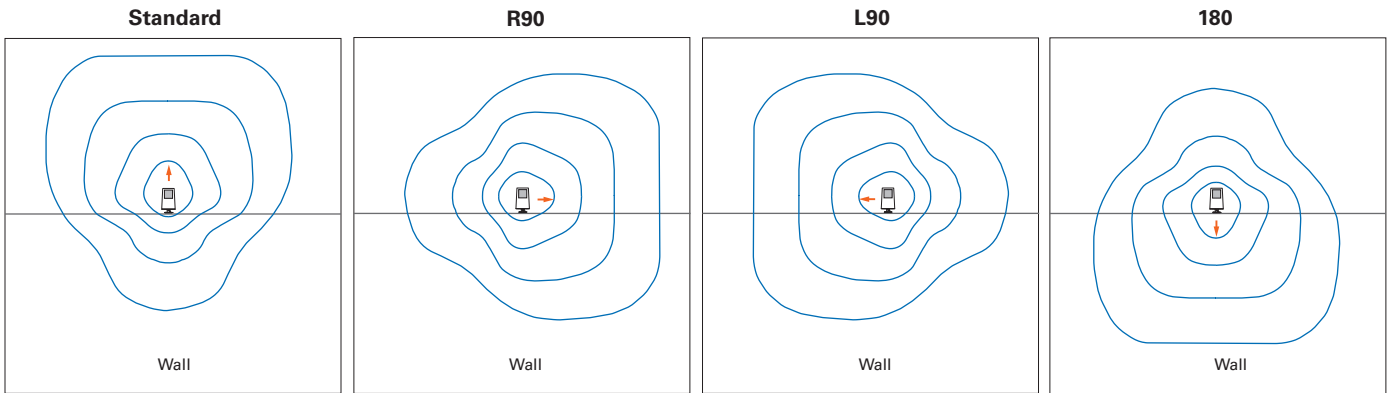

OPTIONS

FM - Optional flush mount option for minimized affect. FM option is not adjustable.

RM - Optional rigid knuckle mount for downward facing, fixed applications. Available in standard optic orientation only.

Extension Arm Length:
Specify to the inch between min and max length

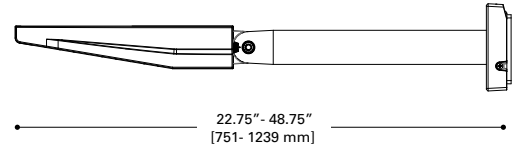
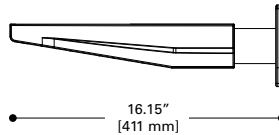
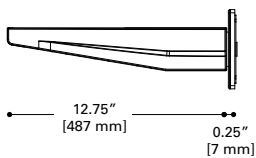
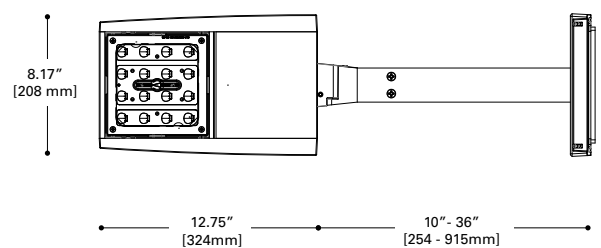
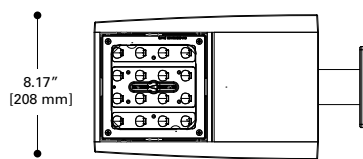
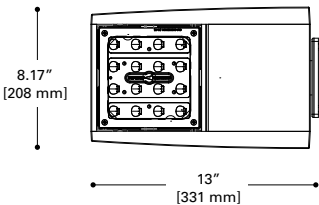

TECHNICAL NOTES

1. Integral Sensor cannot be selected in "D", downlight orientation. Integral sensor available in single circuit option only and is not available with DALI option. Integral sensor optimum coverage height: 8ft for SL/S1/S2 and 40ft for S3/S4/L3/L4/L5/L6. Integral sensor color is white for "White" finish selection and brown for "silver, bronze, or black" finish selections.
2. DesignLights Consortium™ Qualified, and classified for DLC Standard. Refer to www.designlights.org for details on exact qualified ASYX 2.0 product as not all configurations are DLC classified. Extension Arms are not DLC classified.
3. Not available with "C" surface mount junction box option.
4. See "Control" section for explanation.



Excellence in Illumination Engineering Software
since 1984



sample banner copyright 2013 Lighting Analysts, Inc.

W1

Photometric Report (Type C)

Filename: W1_AMETRIX_ASYX-S-1-W-X-X-L35-1-STD-UNV.ies
[TEST] P166672 TEST IS SCALED FROM IESNA LM-79-08 TEST
DATA (P25394)
[TESTLAB] INNOVATIONS CENTER-P2
[ISSUE DATE] 3/17/2015
[MANUFAC] EATON - AMETRIX (FORMER COOPER LIGHTING)
[LUMCAT] ASYX-S-1-W-X-X-L35-1-STD-UNV
[LUMINAIRE] AMETRIX ASYMMETRIC INDIRECT LED LUMINAIRE,
SMALL HOUSING. (1) LIGHTSQUARE WITH 16 LEDS EACH AND
TYPE IV WIDE OPTICS
[LAMP] (16) 3500K CCT, 80 CRI LEDS

Maximum Candela = 1549.8 at 45 H 110 V

Classification:

Upward Wast Light Ratio: 1.00
Luminaire Efficacy Rating (LER): 78
Indoor Classification: Indirect
BUG Rating : B0-U5-G0

Polar Candela Curves:

Vertical Plane Through:
1) 45 - 225 Horizontal

Horizontal Cone Through:
2) 110 Vertical

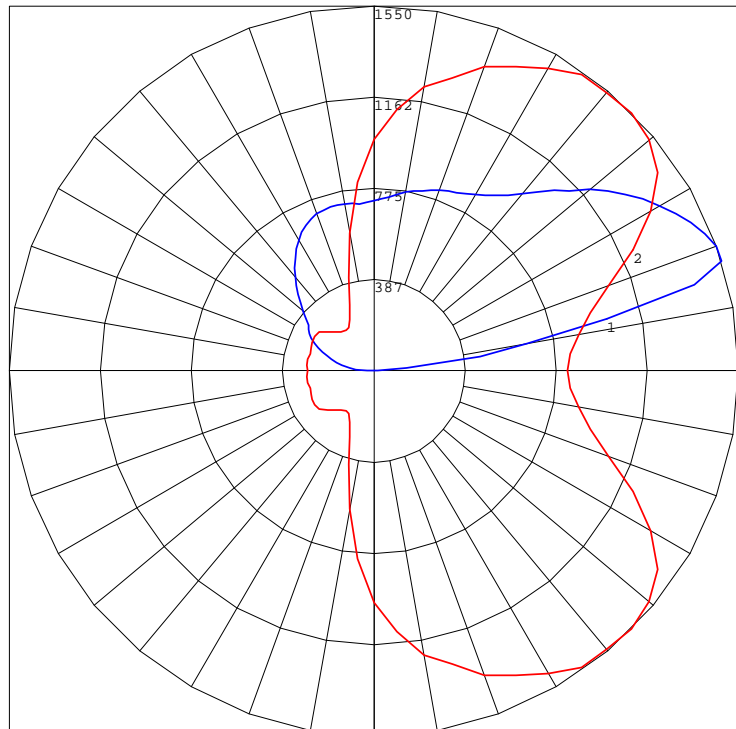



Excellence in Illumination Engineering Software
since 1984



sample banner copyright 2013 Lighting Analysts, Inc.

W1

Photometric Report (Type C)

Filename: W1_AMETRIX_ASYX-S-1-W-X-X-L35-1-STD-UNV.ies
 [TEST] P166672 TEST IS SCALED FROM IESNA LM-79-08 TEST
 DATA (P25394)
 [TESTLAB] INNOVATIONS CENTER-P2
 [ISSUEDATE] 3/17/2015
 [MANUFAC] EATON - AMETRIX (FORMER COOPER LIGHTING)
 [LUMCAT] ASYX-S-1-W-X-X-L35-1-STD-UNV
 [LUMINAIRE] AMETRIX ASYMMETRIC INDIRECT LED LUMINAIRE,
 SMALL HOUSING. (1) LIGHTSQUARE WITH 16 LEDS EACH AND
 TYPE IV WIDE OPTICS
 [LAMP] (16) 3500K CCT, 80 CRI LEDS

Maximum Candela = 1549.8 at 45 H 110 V

Classification:

Upward Waste Light Ratio: 1.00
 Luminaire Efficacy Rating (LER): 78
 Indoor Classification: Indirect
 BUG Rating : B0-U5-G0

LCS Summary:

LCS Zone	Lumens	%Lamp	%Lum
FL (0-30)	0.0	N.A.	0.0
FM (30-60)	0.0	N.A.	0.0
FH (60-80)	0.0	N.A.	0.0
FVH (80-90)	0.0	N.A.	0.0
BL (0-30)	0.0	N.A.	0.0
BM (30-60)	0.0	N.A.	0.0
BH (60-80)	0.0	N.A.	0.0
BVH (80-90)	0.0	N.A.	0.0
UL (90-100)	132.3	N.A.	3.1
UH (100-180)	4118.7	N.A.	96.9
Total	4251.0	N.A.	100.0
BUG Rating	B0-U5-G0		

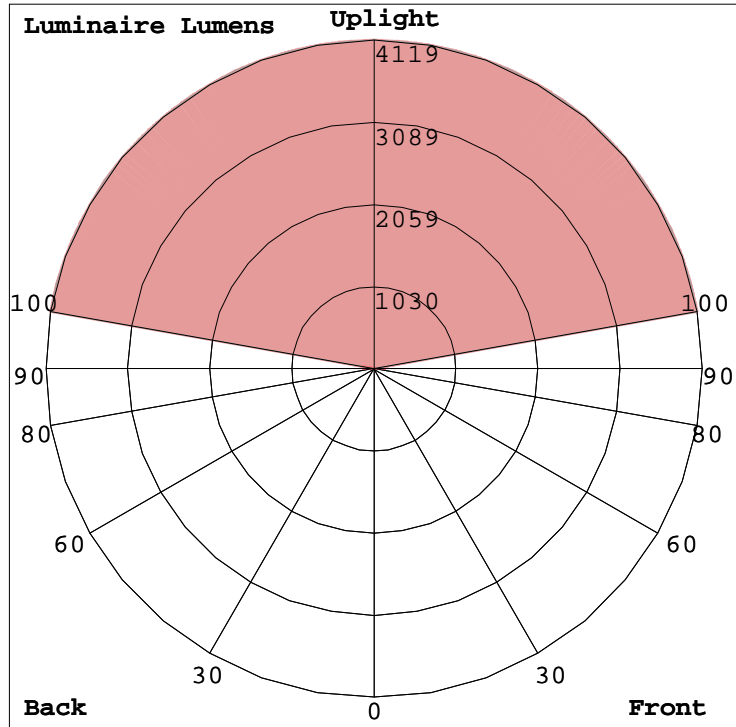



WALL / CEILING MOUNT
LED

Fixture Type	Date
Job Name	Approved By
Catalog Number	

SPECIFICATIONS

ADA Compliant



- Description** The Aria series features a durable, color-impregnated polycarbonate housing supported by a marine grade, die cast aluminum base plate to provide a lighting fixture that will survive in the harshest environments. The fixture has been installed successfully in large scale projects such as dorm rooms, unsecured hallways, transportation stations and public schools. Additionally, multiple colors and trim options are available to compliment nearly any architecture.
- Trim** One piece injection molded UV stabilized polycarbonate secured to base plate with (2) stainless steel TORX® head screws and sealed against moisture and contaminants with two high temperature silicone O-rings. Color is molded through entire part for scratch resistant finish.
- Lens** One piece injection molded UV stabilized prismatic polycarbonate with minimum 0.130" wall thickness. Available in Clear or Opal and secured to base plate by trim and silicone O-rings.
- Reflector** Die formed heavy gauge specular aluminum, shaped for maximum efficiency.
- Base Plate** Pressure die cast marine grade aluminum. Chemically primed and finished with electrostatically applied polyester powder coat.
- LED** Samsung LM561B series @ 3000K, 3500K or 4000K and 82 CRI wired in parallel-series. L₇₀ projected life of over 130,000 hours at 50°C. Ten year warranty on LED boards against operational defects.
- Gasket** Closed cell die cut neoprene gasket provided between fixture base plate and mounting surface. High temperature silicone O-ring between lens and base plate.
- UL Listing** U.L., C.U.L., Wet standard. 1598a Marine Listed.
- Lifetime Warranty** Luminaire LED Incorporated will repair or replace any fixture damaged due to vandalism for the lifetime of the installation.

DIMENSIONAL DATA

	A	B	C
AOV 13	8.75	13.13	3.85
BOVH 13	8.75	13.13	4.00
BOW 13	8.75	13.13	4.00
XOV 13	8.75	13.13	4.00
YOVB13	8.75	13.13	4.00
YOVW 13	8.75	13.13	4.00

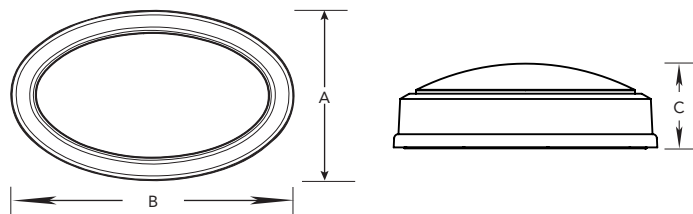

ORDERING INFORMATION

SERIES	LED	CCT	VOLTS	LENS	COLOR	OPTIONS		TX/SD
AOV 13	15W	3000K	120-277	CP	BLK	PC	EMB310	
BOVH 13		3500K		OP	WHT	GLR	EMB20R	
BOV 13		4000K			BRZ	CAB	EMB125R	
XOV 13					GRY	WMB	EMB250R	
YOVB 13					CUST		EMB375R	
YOV 13							ST/SC	

OPTIONS

LENS	CP = Clear Prismatic Standard	OP = Opal Optional			
COLORS	BLK = Black	WHT = White	BRZ = Bronze	GRY = Gray	CUST = Custom Color (Consult Factory)
PC	Photoelectric switch. (requires CAB option).				
GLR	Fuse and fuse holder.				
CAB	Cast aluminum back box. Provided with (5) 1/2" i.p.t. holes for conduit entry and (4) threaded plugs. Chemically primed and finished with electrostatically applied polyester powder coat. (CAB height 3.74")				
WMB	Cast aluminum 700 series wiremold adapter.				
EMB310	650 lumen self contained, 90 minute emergency battery pack. 0°C (32°F) to 55°C (131°F). Not available in 347V. CAB required.				
EMB20R	Stand-alone inverter that will operate a 25W maximum load for 90 minutes. Select ceiling grid, recessed wall or surface mount. 20°C (68°F) to 30°C (86°F).				
EMB125R	Stand-alone inverter that will operate a 125W maximum load for 90 minutes. 20°C (68°F) to 30°C (86°F). Not available in 347V.				
EMB250R	Stand-alone inverter that will operate a 250W maximum load for 90 minutes. 20°C(68°F) to 30°C (86°F). Not available in 347V.				
EMB375R	Stand-alone inverter that will operate a 375W maximum load for 90 minutes. 20°C(68°F) to 30°C (86°F). Not available in 347V.				
ST/SC	Slotted screws instead of TORX® head.				
TX/SD	TORX® head bit.				

TRIM OPTIONS





Photometric Report (Type C)

Filename: W2_Luminaire LED_AOV13-15W-4000K-CP.ies

[TEST] LLI-14258-1

[TESTLAB] LightLab International (www.LightLabInt.com)

[ISSUEDATE] Thursday, 23 October 2014 11:35:47 AM

[MANUFAC] Luminaire LED, Inc., Edison, New Jersey, 08817

[LUMCAT] AOV13-15W 4000K CP

[LUMINAIRE] Luminaire LED surface mount/canopy oval

luminaire. Cat No:AOV13-15W 4000K CP Cast alum. base, plastic wall retains a convex oval diffuser. Luminaire extents ~13-1/8x8-3/4x3-1/2" deep. Diffu

Maximum Candela = 445.33 at 90 H 6.5 V

Classification:

Road Classification: Type VS, Very Short, N.A. (deprecated)

Upward Waste Light Ratio: 0.01

Luminaire Efficacy Rating (LER): 84

Indoor Classification: Direct

BUG Rating : B1-U1-G0

LCS Summary:

LCS Zone	Lumens	%Lamp	%Lum
FL (0-30)	177.2	N.A.	15.5
FM (30-60)	301.1	N.A.	26.4
FH (60-80)	77.8	N.A.	6.8
FVH (80-90)	9.8	N.A.	0.9
BL (0-30)	177.2	N.A.	15.5
BM (30-60)	301.1	N.A.	26.4
BH (60-80)	77.8	N.A.	6.8
BVH (80-90)	9.8	N.A.	0.9
UL (90-100)	6.0	N.A.	0.5
UH (100-180)	2.0	N.A.	0.2
Total	1139.8	N.A.	100.0
BUG Rating	B1-U1-G0		

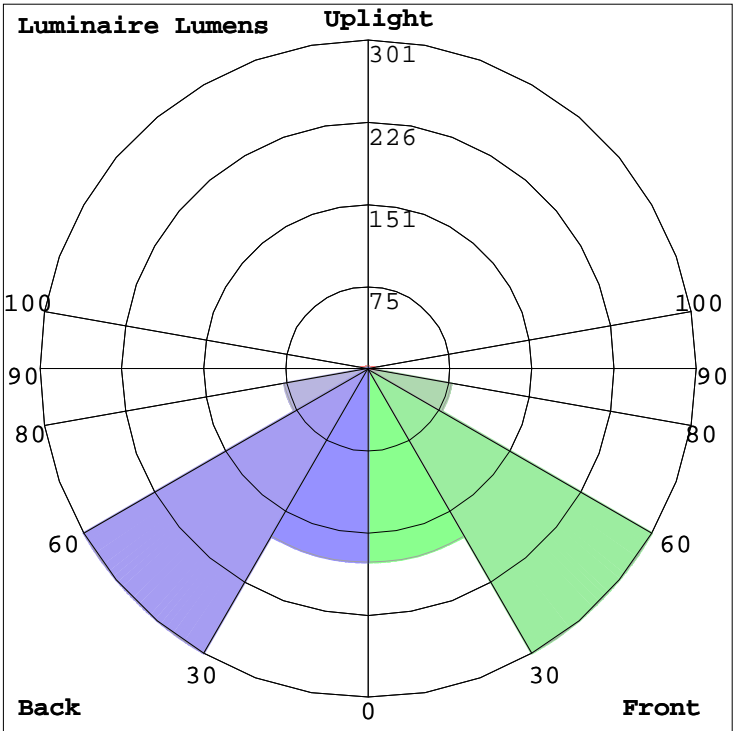



Date:	Approved:
Type:	
Fixture:	
Project:	

FCQS410

4" Square Wall, Pendant or Surface Mounted Die-Cast Aluminum Cylinder for Single Direction Lighting Only.



W3

ORDERING

EXAMPLE: FCQS410W-120V-3K-1200-BK-NFL

SERIES	VOLTAGE	SOURCE	TEMPERATURE	LAMP	FINISH	BEAM OPTICS	ACCESSORIES
FCQS410	120V	LED	3K	600 Lumens (10W)	BK Black	SP Spot	LD LED Dimming (0-10V)
FCQS410P	277V		35K	1800 Lumens (43W) (1 direction only)	BZ Bronze	NFL Narrow Flood	APL Additional Pendant Length
	347VΔ		4K		SL Silver	FL Flood	EMR Emergency Backup, Remote
					WH White	WFL Wide Flood	
					CC Custom Color		

SPECIFICATION

MOUNTING

- Mounts directly to standard recessed junction box. Additional mounting holes allow unit to be attached directly to mounting surface.
- Pendant (18 in, standard length) with swivel canopy. Consult factory for additional pendant lengths.

CONSTRUCTION

- Marine grade, corrosion resistant, heavy walled, high pressure die-cast aluminum with die-cast back mounting plate.
- Lens is 1/4" thick clear, tempered glass. Precision formed semi-specular aluminum for maximum reflectance.
- Continuous silicone gasket to seal out contaminants. Hidden fasteners allow for cover removal to facilitate installation and service.

LED

- Lumens stated are the minimum delivered out of the luminaire. LED lifetime is 70,000+ hours with the lumen depreciation greater than L70. All of our luminaires are LM-80 tested, are \geq CRI 80 and have a 4-step MacAdam Ellipse color consistency. Integral power supply standard. Input voltage 120V or 277V standard. Consult factory for other voltages and any single color options.

FINISH

- Six stage chemical pre-treatment process that includes iron phosphate, to prepare the substrate for a UV stable, super durable standard polyester powder coat.

ELECTRICAL

- Ballast** UL listed ballast standard. Ballast has a manufacturer issued 5 year warranty. Please consult factory for other voltage options.

LISTING

- UL & cUL/ETL, U.S. and CA listed for wet location in down position. IP65 Rating.

DIMENSIONS

FCCSQ410

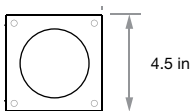
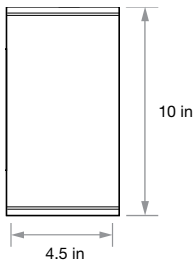

FCCSQ410P

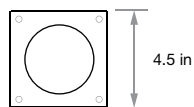
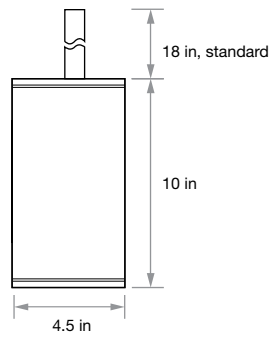

FCCSQ410W

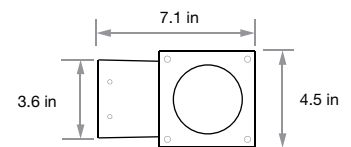
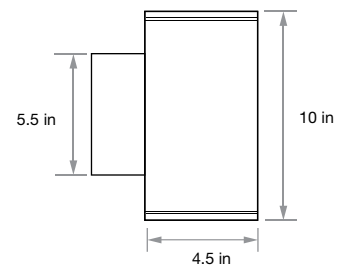



Excellence in Illumination Engineering Software
since 1984



sample banner copyright 2013 Lighting Analysts, Inc.

W3

Photometric Report (Type C)

Filename: FCC410W-D-90.IES
[TEST] TypeC Intensity
[TESTLAB] FC/SSL Lab
[MANUFAC] FC/SSL Lighting
[LUMINAIRE] 4" Round Wall, Pendant or Surface Mounted
Die-Cast Aluminum Cylinder.
[LAMP] LED

Maximum Candela = 1489.6 at 0 H 0 V

Classification:

Road Classification: Type V, Very Short, N.A. (deprecated)
Luminaire Efficacy Rating (LER): 44
Indoor Classification: Direct
BUG Rating : B1-U1-G0

Polar Candela Curves:

Vertical Plane Through:
1) 0 - 180 Horizontal

Horizontal Cone Through:
2) 0 Vertical

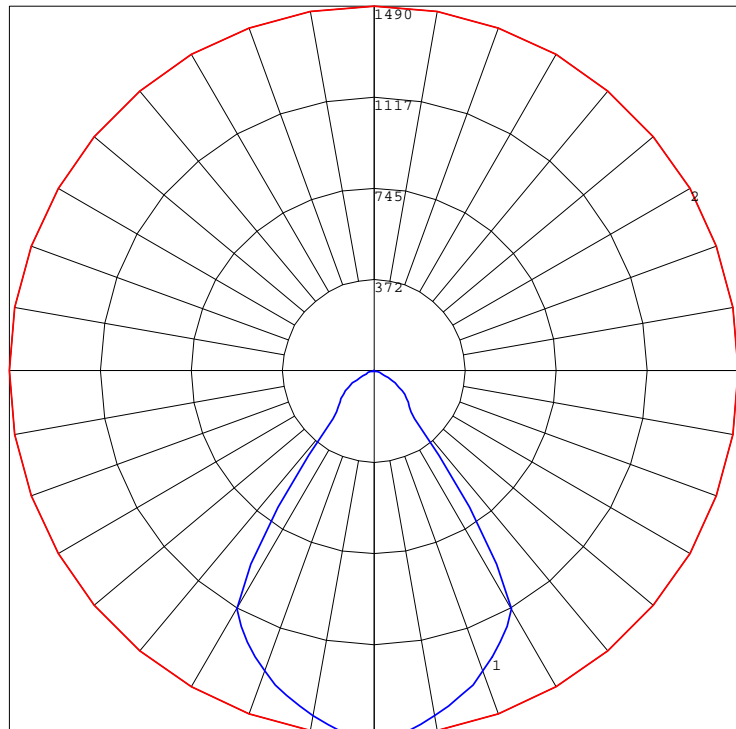



Type:

Project:

Modified:

Quantity:

Notes: **PLEASE READ** - When using a control system, consult dimming system manufacturer with minimum load before installing 12V AC transformer. Malfunction and damage to product due to improper dimming system installation or misuse will not be covered under warranty. Only DC Drivers are recommended for dimming systems. Consult MP Lighting for recommended drivers

L91

- Application** Exterior/interior wall mounted for up or down illumination.
- IP Rating** -
- Mounting** Mounts to standard 4" (102mm) octagonal box (1-1/2" / 38mm minimum depth). Can be positioned facing up or down.
- Electrical** 2.5W, 700mA LED. Powered by integral 120V primary, 3W 700mA non-dimmable driver.
DC - Powered by integral 120V primary, 3W 700mA non-dimmable driver. Recommended LED3W700 (included). Dimmable with dimming controller, 0-10V dimming (not included).
AC - Recommended TLW120MT050-01 magnetic transformer (not included). Consult factory for dimming option.
- Power Consumption** 3 Watt (700 mA, 2.5Watt)
- Light Output** 2.5 Watt, 33~86lm
*For photometric data, see page 02
- Warranty** 5 years limited warranty
Estimated useful life of LED is 50,000 hours.
- Material** Anodized aluminum, insert trim with 1/4"(6mm) thick tempered glass lens. RoHS compliant
- Weight** 2.02lbs (0.914kg)
- Approval** 



Note: Can be used as emergency backup lighting in conjunction with Bodine emergency 20W micro inverter (ELI-S-20). *Remote

Order Guide

Example: L91-2-W20S-S-C-0-A-MA

Code	Wattage	Color	Beam	Lens	Angle Bracket	Input Voltage	Finish
L91	- 2						
	2=2.5W	W20S = 2000L, std CRI W27S = 2700K, std CRI W30S = 3000K, std CRI W35S = 3500K, std CRI W41S = 4100K, std CRI W27H = 2000K, high CRI W30H = 3000K, high CRI W35H = 3500K, high CRI	S = spot (12°) N = narrow flood (30°) W = wide flood (120°)	C = clear F = frosted	0 = no angle 30 = 30° angle X = custom (30° max.)	A = 12V AC D = DC	MA = matte clear anodized WH = white



DIMENSION:

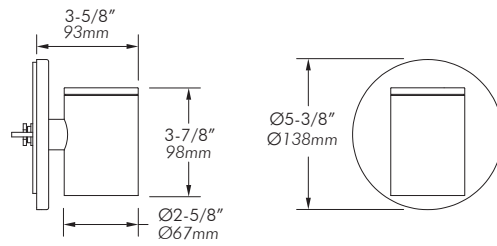

Shown with angle bracket

Shown with no angle bracket

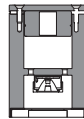
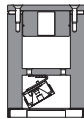

PHOTOMETRIC DATA:

2W, 3000k, 30°

2W, 3000k, 120°

Polar Candela Distribution

Illuminance at a Distance

Polar Candela Distribution

Illuminance at a Distance

Lumen: 86lm

Lumen: 33lm

Polar Candela Distribution

Isofootcandle Plot

Polar Candela Distribution

Isofootcandle Plot

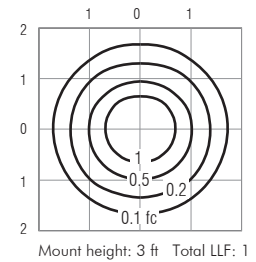
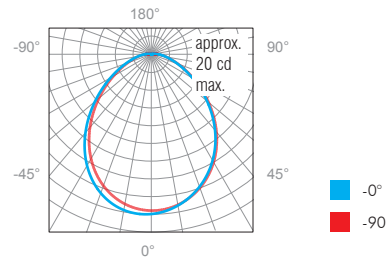
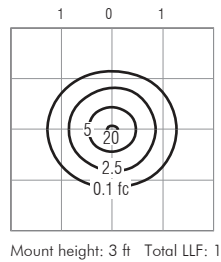
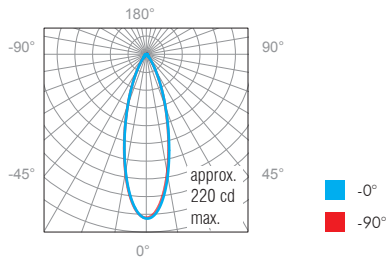

Note: Various operating factors may cause differences between lab and field results. As specifications may change without notice, please refer to the LED Lamp Index located in the "Downloads" section of each product webpage for the most current information.



Excellence in Illumination Engineering Software
since 1984



sample banner copyright 2013 Lighting Analysts, Inc.

W4

Photometric Report (Type C)

Filename: W4_MP Lighting_L91-2W30S120C0.ies
[TEST] MP LIGHTING
[ISSUEDATE] 24/06/2013 L92-2W30S120C0
[MANUFAC] MP LIGHTING
[LUMCAT] L92-2W30S120C0

Maximum Candela = 20 at 0 H 0 V

Classification:

Road Classification: Type VS, Very Short, Cutoff (deprecated)
Upward Waste Light Ratio: 0.01
Luminaire Efficacy Rating (LER): 49
Indoor Classification: Direct
BUG Rating : B0-U1-G0

LCS Summary:

LCS Zone	Lumens	%Lamp	%Lum
FL (0-30)	7.5	6.5	15.2
FM (30-60)	12.1	10.5	24.5
FH (60-80)	3.9	3.4	8.0
FVH (80-90)	0.8	0.7	1.7
BL (0-30)	7.6	6.6	15.4
BM (30-60)	12.1	10.5	24.5
BH (60-80)	3.9	3.4	8.0
BVH (80-90)	0.8	0.7	1.7
UL (90-100)	0.5	0.5	1.1
UH (100-180)	0.0	0.0	0.0
Total	49.2	42.8	100.0
BUG Rating	B0-U1-G0		

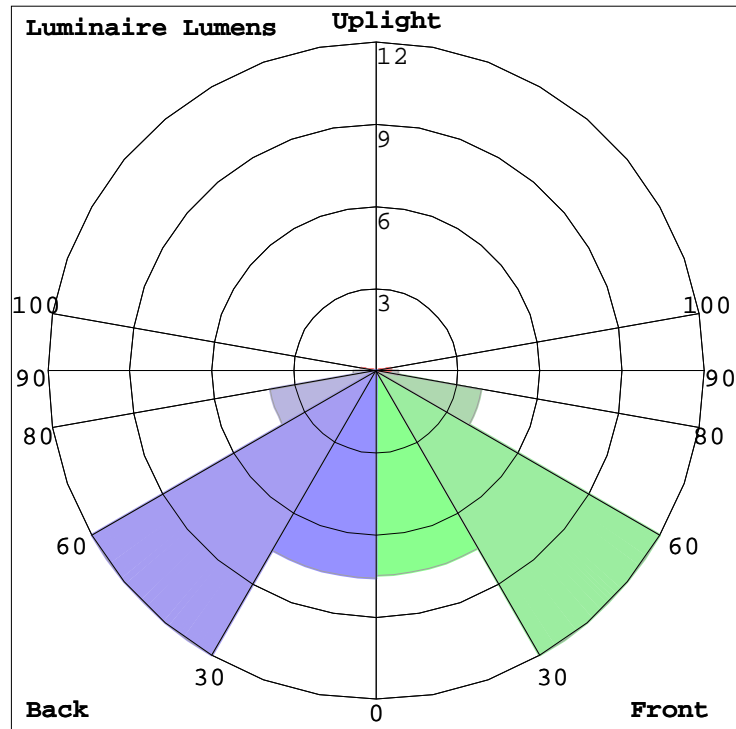

PLATE OUT 3450

W5

PROJECT PROJÉT
SPEC TYPE
NOTES



OPTIONS



WHE

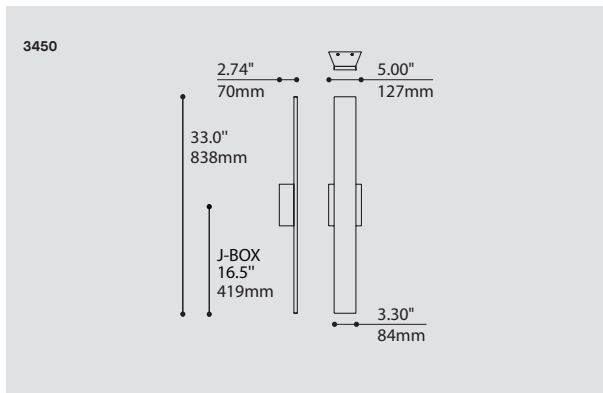

ORDERING SPECIFICATION	SPÉCIFICATION DE COMMANDE	CODE
MODEL MODÈLE		3450
3450	PLATE OUT	
LIGHT SOURCE SOURCE LUMINEUSE		
<small>(WATTAGE, LAMP TYPE, OTHER INFO)</small>		
2XLED.5.30	5W X 2, LED 3000K (WARM)	
2XLED.5.40	5W X 2, LED 4000K (NEUTRAL)	
2XLED.6.30	6W X 2, LED HO 3000K (WARM)	
2XLED.6.40	6W X 2, LED HO 4000K (NEUTRAL)	
VOLTAGE VOLTAGE		
120V	120 VOLT	
277V	277 VOLT	
STRUCTURE FINISH FINI STRUCTURE		
WHE	WHITE FINE TEXTURE	
ANTE	ANTHRACITE FINE TEXTURE	

PRODUCT CHARACTERISTICS CARACTÉRISTIQUES DU PRODUIT



DESIGN:	Designed for use in outdoor corridors and public areas. This wall mounted indirect luminaire is an extended version of the Plate interior.
LIGHT SOURCE:	5W X 2 and 6W X 2 LED in 3000K (Warm white) or 4000K (Neutral white) with self-modulating temperature control for maximum performance.
STRUCTURE:	CNC machined aluminum, die-stamped galvanized steel and die-cut silicone gasket.
DIFFUSER:	Translucent frosted acrylic.
CERTIFIED:	c-CSA-us Wet Locations designed for IP64 – Suitable for interior and exterior projects
CONCEPTION:	Conçue pour être utilisée dans les couloirs extérieurs et espaces publics. Cette applique murale à éclairage indirect représente la version étendue du Plate intérieur.
SOURCE LUMINEUSE:	5W X 2 et 6W X 2 DEL disponible en 3000K (blanc chaud) ou 4000K (blanc neutre) avec autocontrôle de température pour une performance maximum.
STRUCTURE:	Aluminium usiné par contrôle numérique, acier galvanisé découpé et plié et joints d'étanchéité en silicone comprimé pour résister aux intempéries.
DIFFUSEUR:	Acrylique givré translucide.
CERTIFIÉ:	c-CSA-us Emplacement mouillé conçu pour IP64 – Convient aux projets intérieurs et extérieurs



Excellence in Illumination Engineering Software
since 1984



sample banner copyright 2013 Lighting Analysts, Inc.

W5

Photometric Report (Type C)

Filename: W5_3450-2XLED.6.ies

[TEST] EURTH

[LUMCAT] PLATE OUT 3450 2XLED.6

[LUMINAIRE] White textured painted structure and housing, White translucent diffuser

[LAMP] 18x0.3W LED Chip Type white SMD

[BALLAST] One SAGE LIGHTING 12W 12CV

Maximum Candela = 169.27 at 180 H 90 V

Classification:

Road Classification: Type I, Very Short, Non-Cutoff (deprecated)

Upward Waste Light Ratio: 0.50

Luminaire Efficacy Rating (LER): 42

Indoor Classification: General Diffuse

BUG Rating : B0-U3-G1

LCS Summary:

LCS Zone	Lumens	%Lamp	%Lum
FL (0-30)	0.4	0.1	0.1
FM (30-60)	0.6	0.1	0.1
FH (60-80)	0.2	0.0	0.0
FVH (80-90)	< 0.05	0.0	0.0
BL (0-30)	9.0	1.3	2.0
BM (30-60)	73.0	10.4	15.9
BH (60-80)	92.8	13.3	20.3
BVH (80-90)	52.9	7.6	11.6
UL (90-100)	53.0	7.6	11.6
UH (100-180)	176.1	25.2	38.4
Total	458.0	65.6	100.0
BUG Rating	B0-U3-G1		

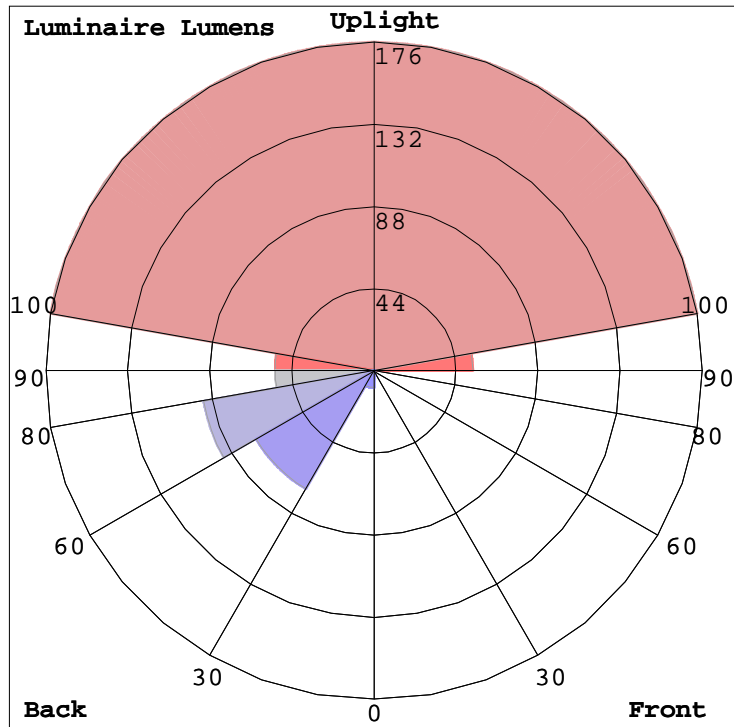

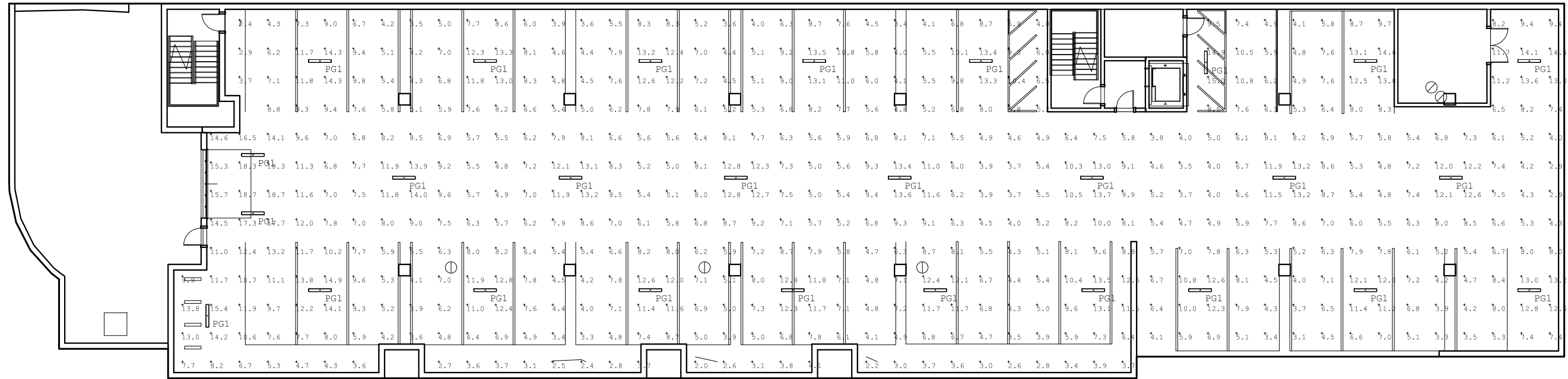

Luminaire Schedule						
Symbol	Qty	Tag	Label	Description	LLF	Lum. Watts
	27	PG1	PG1_4VT2-LD4-4-DR-UNV-L8	Surface Mount Parking Garage Luminaire	0.900	38.1

Calculation Summary						
Label	CalcType	Units	Avg	Max	Min	Avg/Min
P1_Bldgs 1 & 2_Floor	Illuminance	Fc	7.65	18.7	2.0	3.83

P1 Bldgs 1 & 2 LPD
 Area = 14052 Sq.ft
 Total Watts = 1028.7
 Lighting Power Density = 0.073 Watts/Sq.ft

Scale: 1" = 20'-0"

ENTERPRISE
Lighting & Control

imcmasters@enterpriselighting.com
 2007 Pewaukee Road
 Waukesha, WI 53188
 262-953-2700

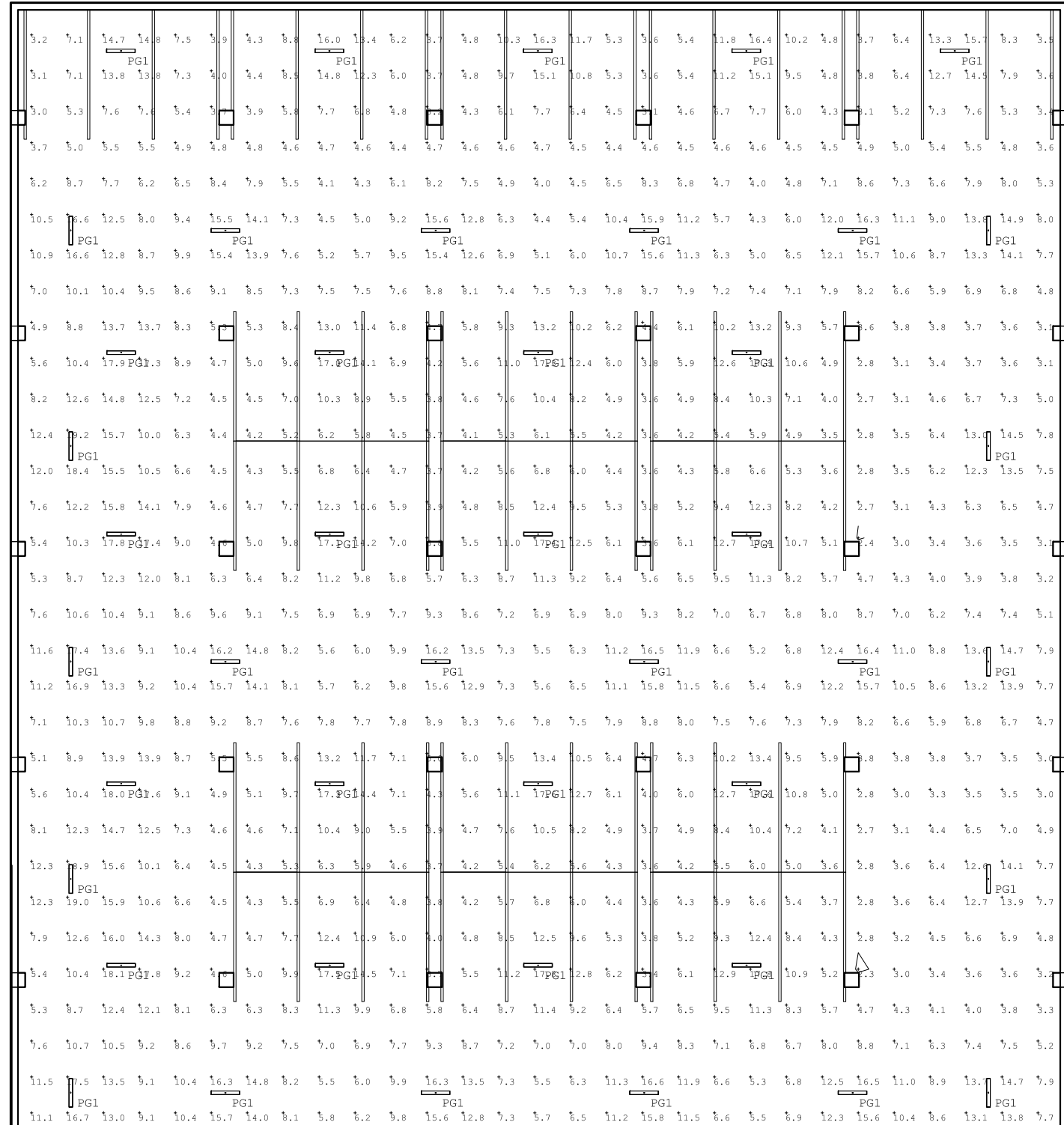

Symbol	Qty	Tag	Label	Description	LF	Lum. Watts
PG1	88		PG1_4V72-L04-4-DR-WW-L6	Surface Mount Parking Garage Luminaire	9,900	38.1

Label	CalcType	Units	Avg	Max	Min	Avg/Min
Level P1 Bldg 5 Bicycle Parking Illuminance	Fc		3.74	13.24	4.20	3.09
Level P1 Bldg 5 Transition Zone Illuminance	Fc		12.33	22.11	4.23	2.93
Level P1 Bldg 5 Floor Illuminance	Fc		4.96	19.27	2.28	3.46
P1 Bldg 5 Elevator Threshold Illuminance	Fc		11.70	12.27	10.6	1.10

P1 Bldg 5 Lighting Power Density

Area = 35817 Sq.ft
 Total Watts = 2590.801
 Lighting Power Density = 0.072 Watts/Sq.ft

Scale: 1" = 20'-0"



imcmasters@enterpriselighting.com

2007 Pewaukee Road

Waukesha, WI 53188

262-953-2700

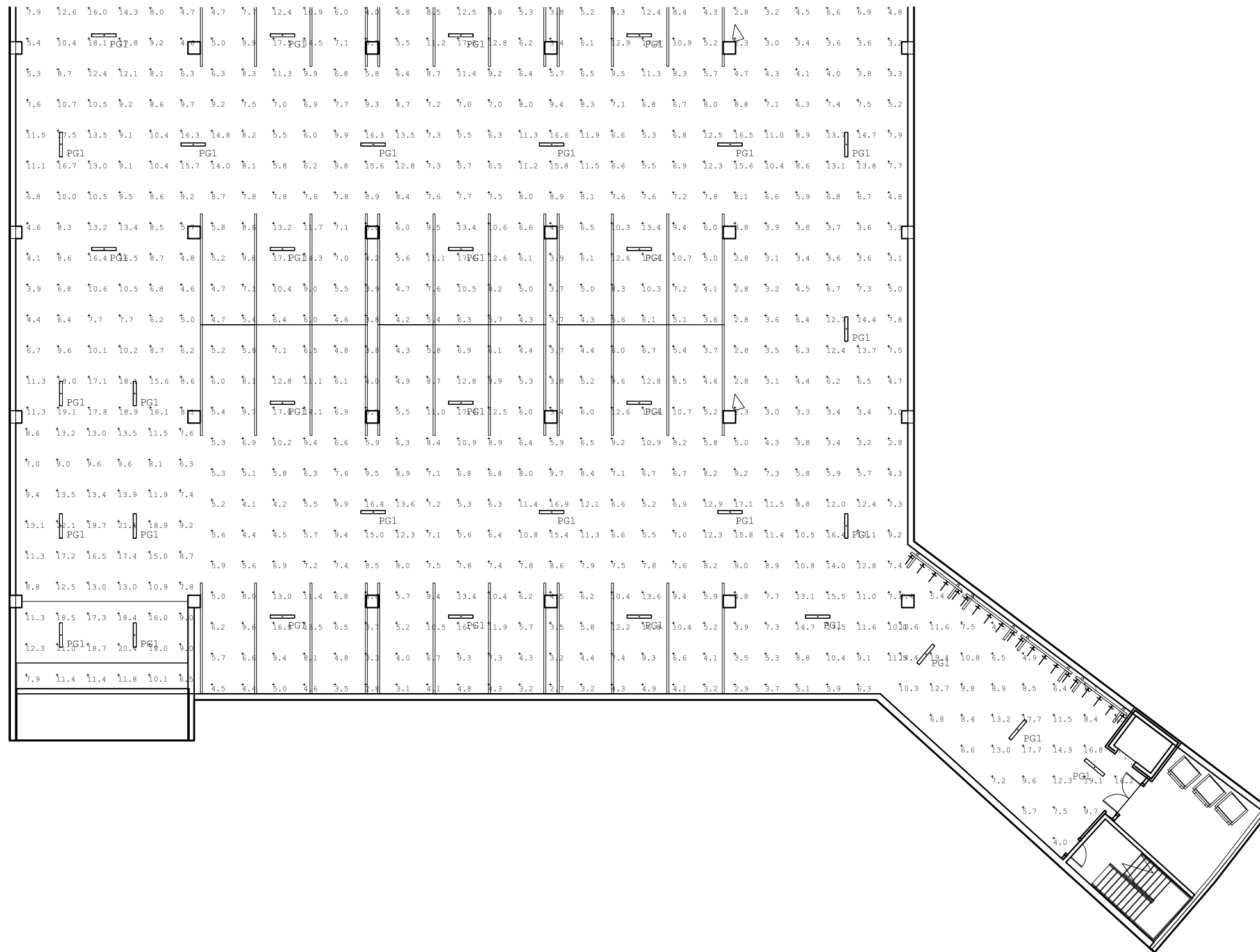

Luminaire Schedule						
Symbol	Qty	Tag	Label	Description	LLF	Lum. Watts
○	10	C1A	C1A SLD606835WH	SURFACE MOUNT DOWNLIGHT	0.900	12.2
○	62	C1B	C1B SLD612835WH	SURFACE MOUNT DOWNLIGHT	0.900	14.8
□	42	C2	C2 ML4D09NFL930-TIR50NFL	ML4D09NFL930-TIR50NFL25-TL43R2G X TL44S2GX	0.900	11.5
□	1	PL1B	GLEON-AF-02-LED-E1-SL3-7	TYPE III AREA LIGHT, 18' POLE ON RAISED BASE	0.900	113
□	18	PL2B	PL2B GLEON-AF-01-LED-E1-	GLEON-AF-01-LED-E1-SL3-7030	0.900	59
□	4	PL2C	PL2C GLEON-AF-01-LED-E1-	GLEON-AF-01-LED-E1-T4FT-7030	0.900	59
□	4	SL1	SL1 FCSL550-LED	RECESSED WALL STEPLIGHT	0.900	6
□	16	SL2	SL2 COLE 1392D L11136307	C1392D-LED-2	0.900	2.61
□	25	W1	W1 AMETRIX ASYX-S-1-W-X-	WALL MOUNTED INDIRECT	0.900	54.7
○	10	W2	W2 Luminaire LED AOV13-1	AOV13-15W 4000K CP	0.900	13.5
□	27	W3	W3 FCC410W-D-90	WALL MOUNTED DOWNLIGHT	0.900	42.8

Calculation Summary						
Label	CalcType	Units	Avg	Max	Min	Avg/Min
Bldg 5 Sidewalk	Illuminance	Fc	2.48	8.2	0.2	12.40
Bldgs 1 & 2 Pkg Ramp 1 Planar	Illuminance	Fc	4.03	6.7	1.7	2.37
Bldgs 1 & 2 Pkg Ramp Side 2	Illuminance	Fc	2.56	3.8	1.7	1.51
Bldgs 3 & 4 Pkg Ramp Side 2	Illuminance	Fc	2.12	6.4	0.9	2.36
L1 Bldgs 3 & 4 Parking entry	Illuminance	Fc	2.00	3.7	1.0	2.00
Memorial Drive	Illuminance	Fc	1.02	4.0	0.3	3.40
Memorial Drive NE Parking	Illuminance	Fc	1.38	2.5	0.5	2.76
Memorial Drive NW Parking	Illuminance	Fc	1.84	3.8	0.5	3.68
Memorial Drive Parking Bldg 5	Illuminance	Fc	1.89	5.3	0.8	2.36
Memorial Drive Parking Retail	Illuminance	Fc	1.50	3.0	0.6	2.50
Memorial Drive Retail Sidewalk	Illuminance	Fc	1.70	13.8	0.2	8.50
Reference for ramp 1 Side 3	Illuminance	Fc	1.29	4.3	0.3	4.30

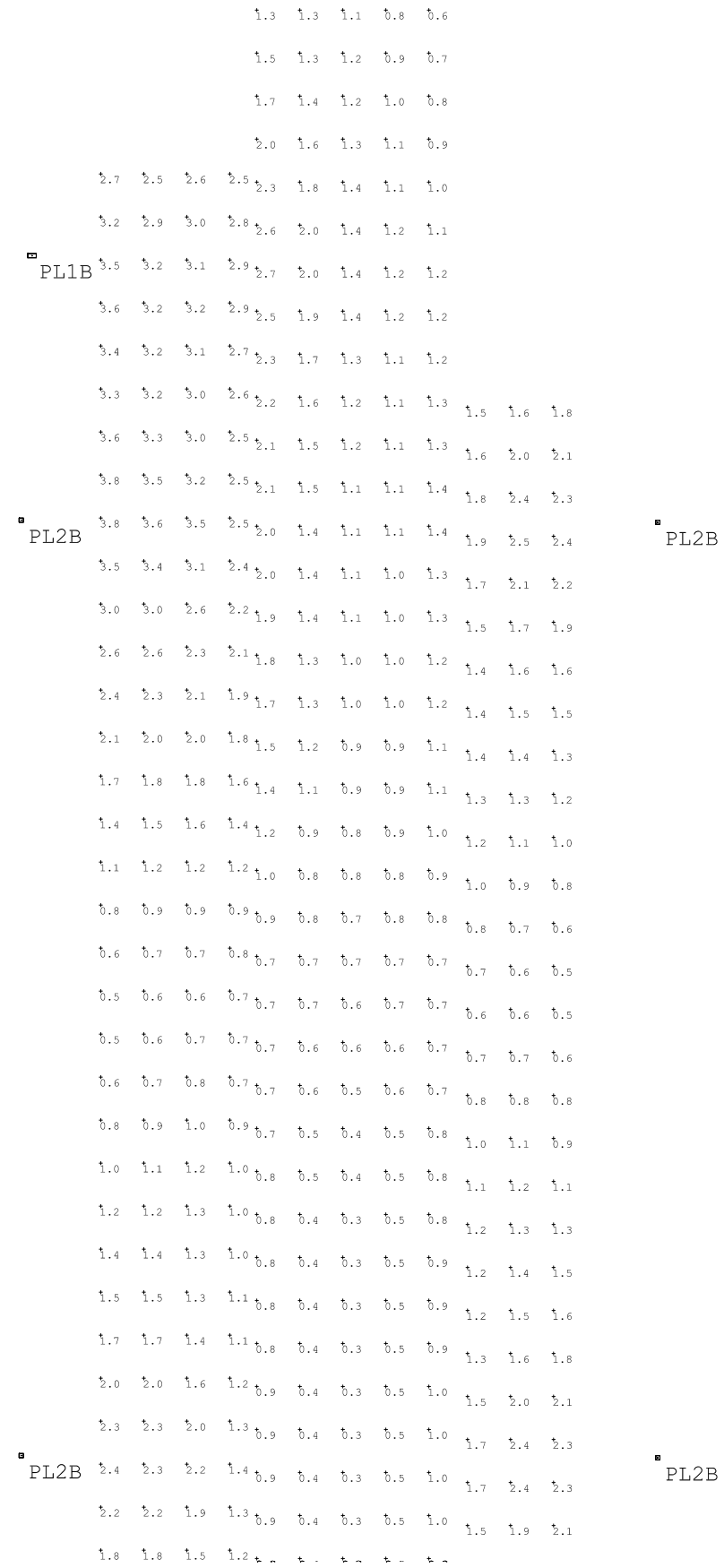

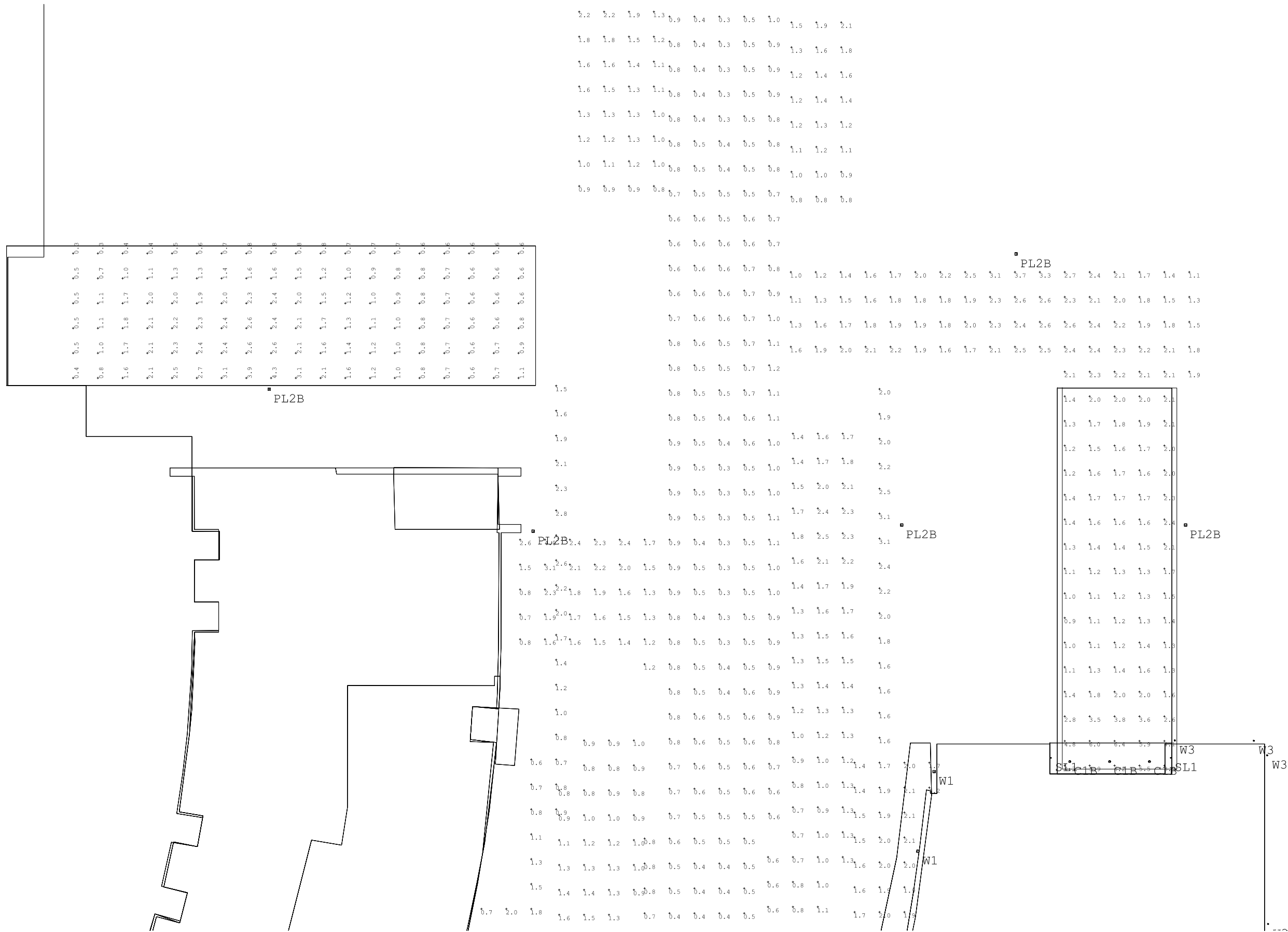

LEVEL 1

MEMORIAL DRIVE

WEST PLACE
Madison, WI

11/21/2016

Scale: 1" = 20'-0"

ENTERPRISE
Lighting & Control

imcmasters@enterpriselighting.com
2007 Pewaukee Road
Waukesha, WI 53188
262-953-2700

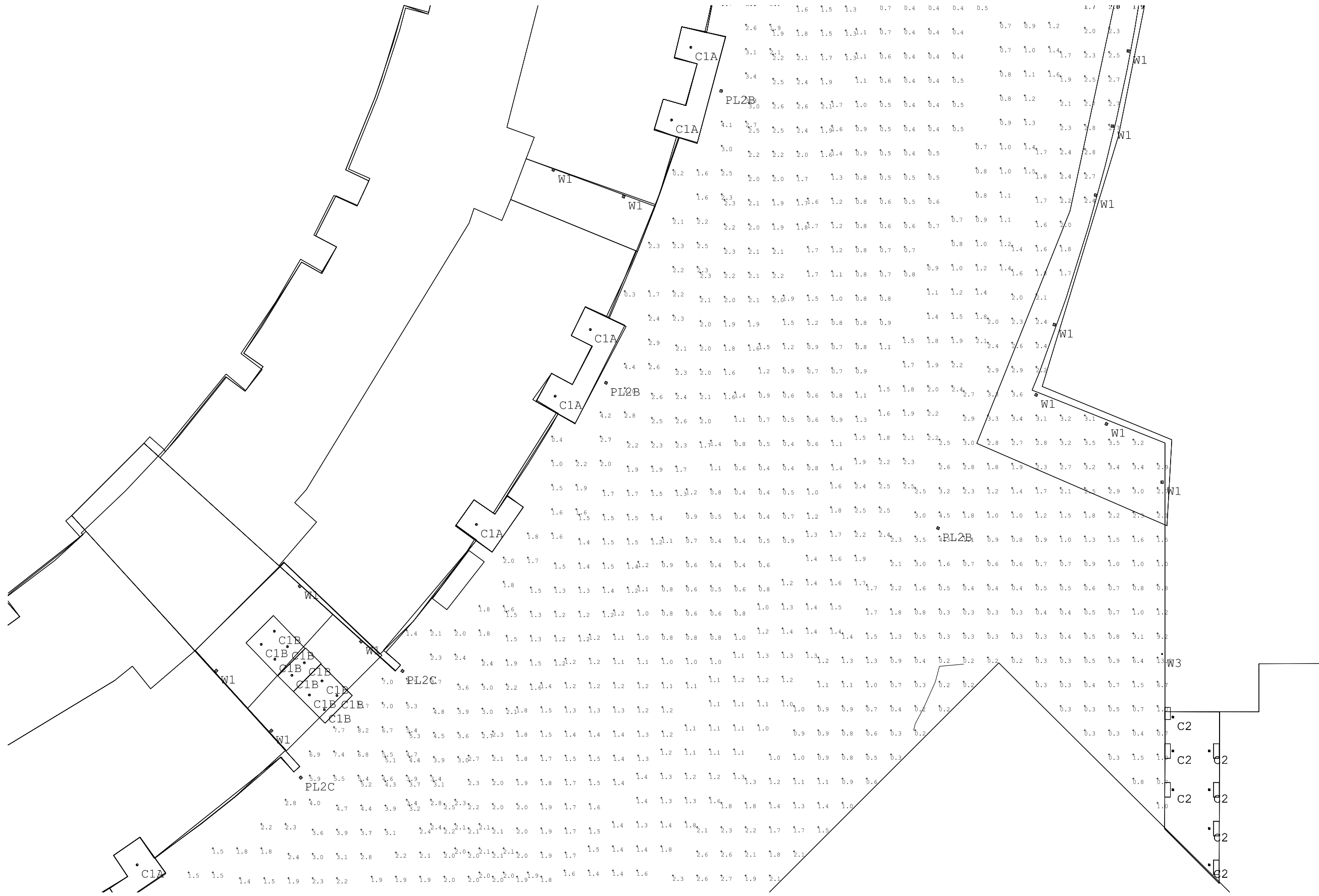

LEVEL 1

MEMORIAL DRIVE

WEST PLACE
Madison, WI

11/21/2016

Scale: 1" = 20'-0"

ENTERPRISE
Lighting & Control

imcmasters@enterpriselighting.com
2007 Pewaukee Road
Waukesha, WI 53188
262-953-2700

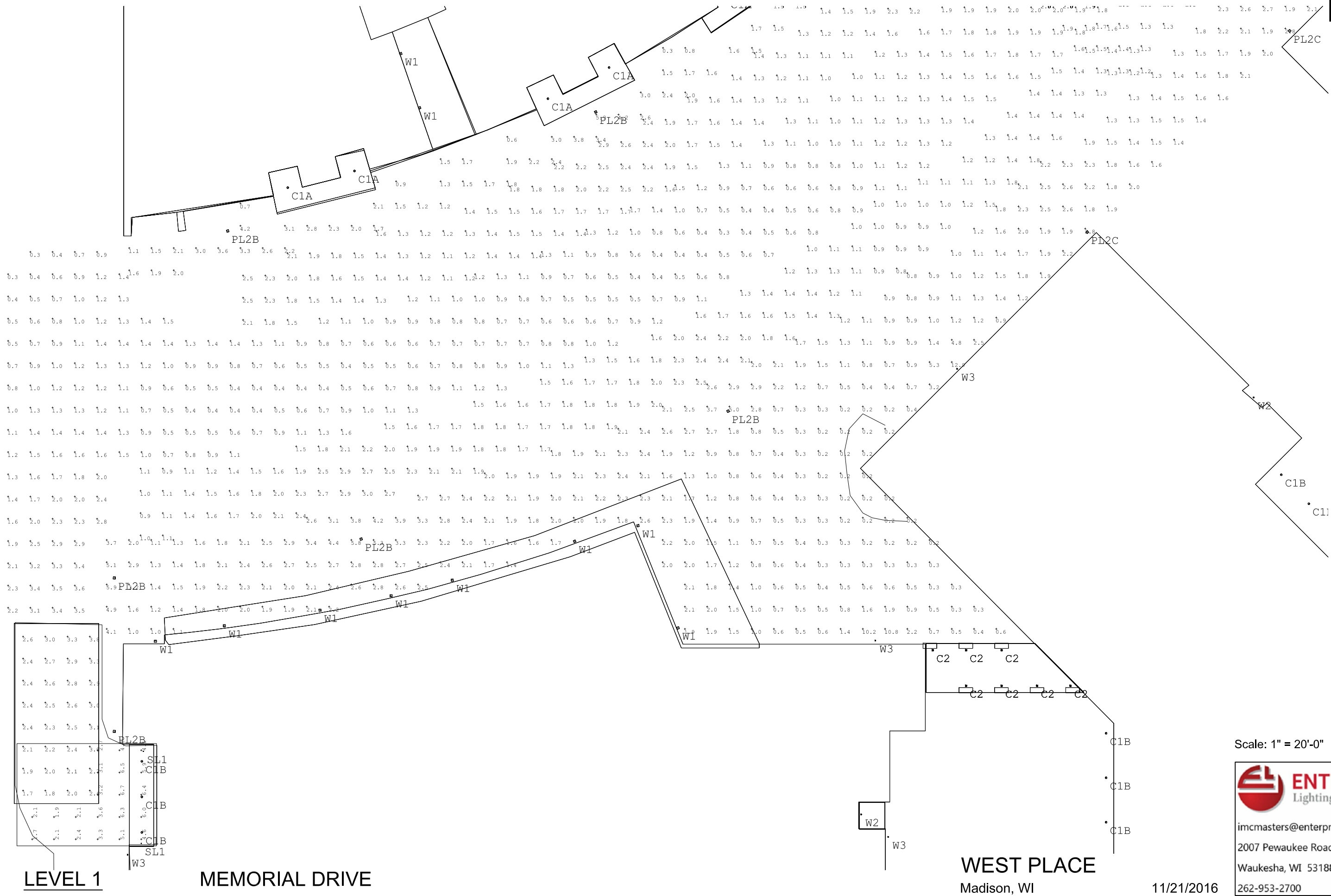

LEVEL 1

MEMORIAL DRIVE

WEST PLACE
Madison, WI

11/21/2016

Scale: 1" = 20'-0"

ENTERPRISE
Lighting & Control

imcmasters@enterpriselighting.com
2007 Pewaukee Road
Waukesha, WI 53188
262-953-2700

Luminaire Schedule						
Symbol	Qty	Tag	Label	Description	LLF	Lum. Watts
⊙	10	C1A	C1A SLD606835WH	SURFACE MOUNT DOWNLIGHT	0.900	12.2
⊙	2	PL1B	GLEON-AF-02-LED-E1-SL3-7	TYPE III AREA LIGHT, 18' POLE ON RAISED BASE	0.900	113
⊙	2	PL1C	PL1C GLEON-AF-02-LED-E1-	GLEON-AF-02-LED-E1-T4FT-7030	0.900	113
⊙	9	PL1D	GLEON-AF-02-LED-E1-5WQ-7	TYPE V AREA LIGHT, 18' POLE ON RAISED BASE	0.900	113
⊙	17	PL2B	PL2B GLEON-AF-01-LED-E1-	GLEON-AF-01-LED-E1-SL3-7030	0.900	59
⊙	4	PL2C	PL2C GLEON-AF-01-LED-E1-	GLEON-AF-01-LED-E1-T4FT-7030	0.900	59
⊙	8	W1	W1 AMETRIX ASYX-S-1-W-X-	WALL MOUNTED INDIRECT	0.900	54.7

Calculation Summary						
Label	CalcType	Units	Avg	Max	Min	Avg/Min
North East Sidewalk	Illuminance	Fc	0.32	0.9	0.1	3.20
North Open Parking	Illuminance	Fc	1.19	7.4	0.3	3.97

North Open Parking LPD

Area = 82242 Sq.ft
 Total Watts = 1130
 Lighting Power Density = 0.014 Watts/Sq.ft

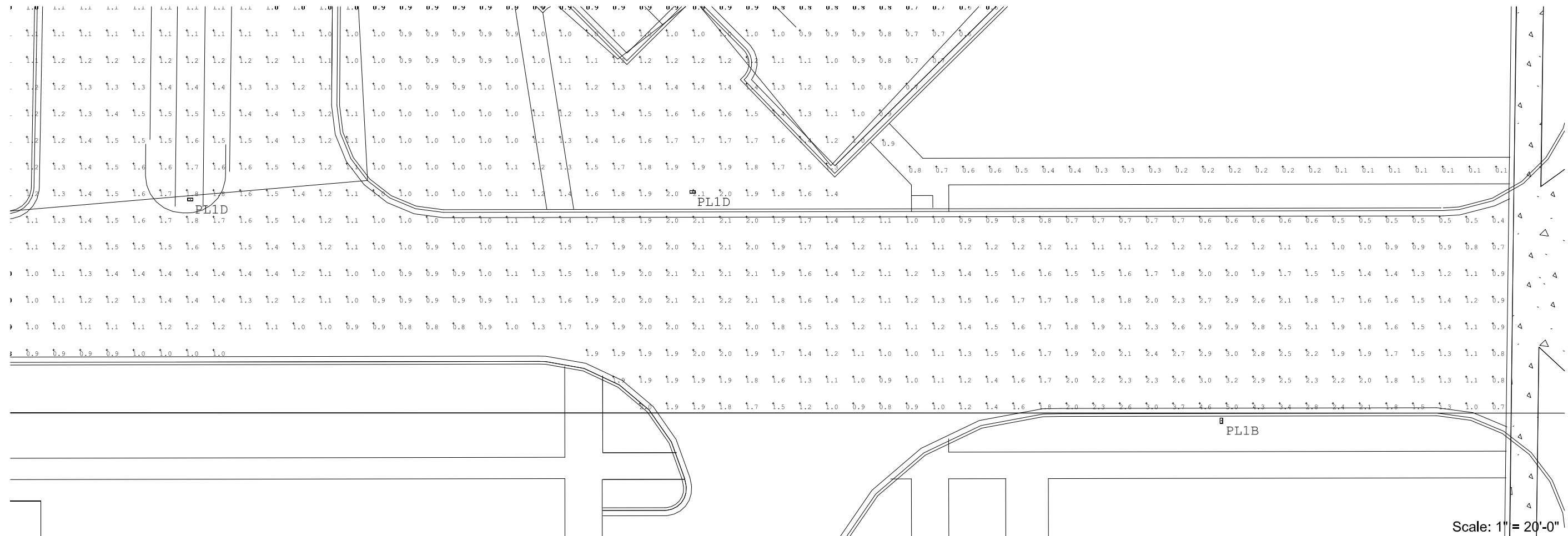

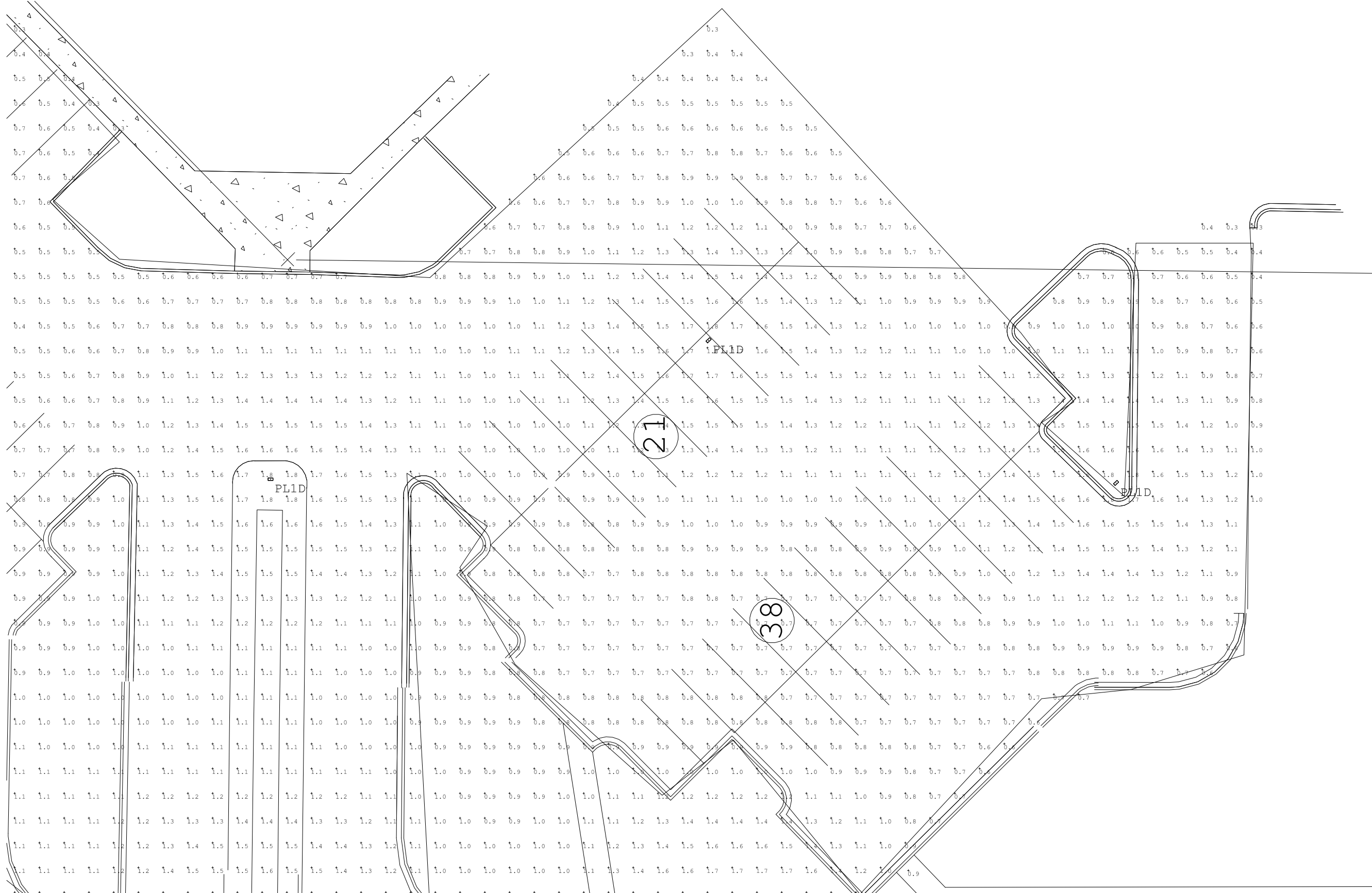

LEVEL 1

EXISTING NORTH PARKING LOT

WEST PLACE
Madison, WI

11/21/2016

Scale: 1" = 20'-0"



ENTERPRISE
Lighting & Control

imcmasters@enterpriselighting.com
2007 Pewaukee Road
Waukesha, WI 53188
262-953-2700

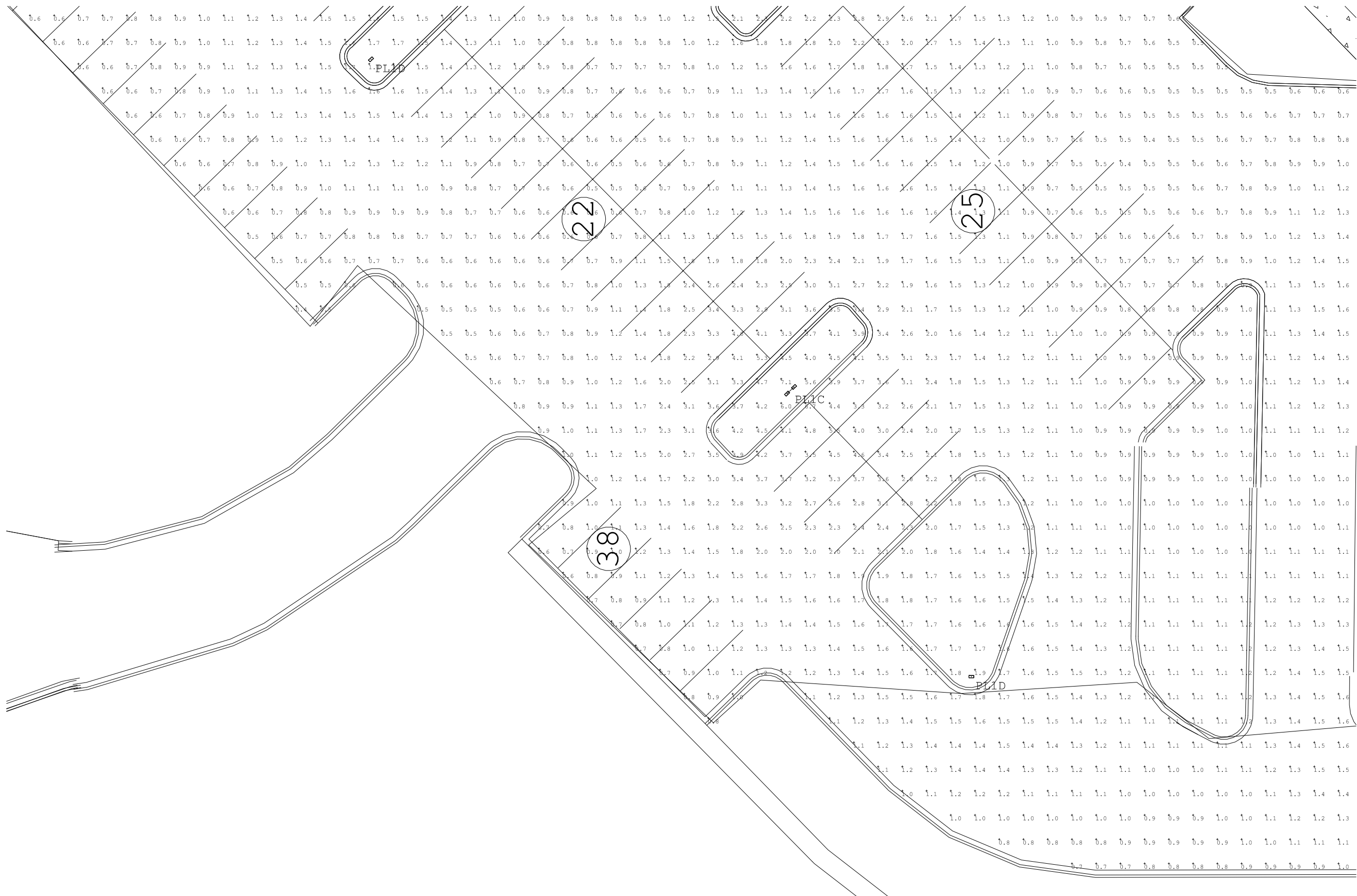

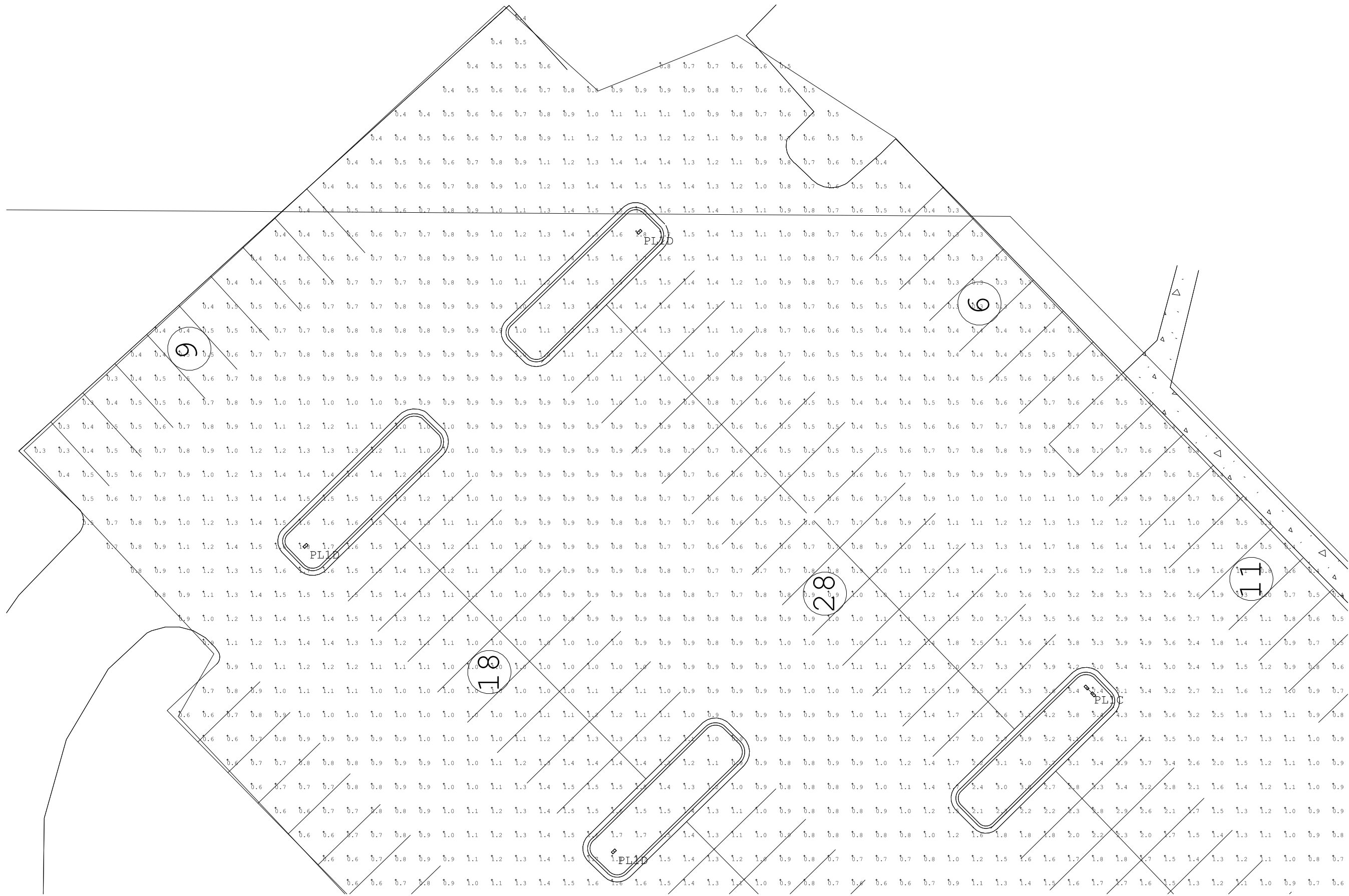

LEVEL 1

EXISTING NORTH PARKING LOT

WEST PLACE
Madison, WI

11/21/2016

Scale: 1" = 20'-0"



ENTERPRISE
Lighting & Control

imcmasters@enterpriselighting.com
2007 Pewaukee Road
Waukesha, WI 53188
262-953-2700

ILLUMINATION AT SIDEWALK PROVIDED FROM EXISTING BUILDING LUMINAIRES

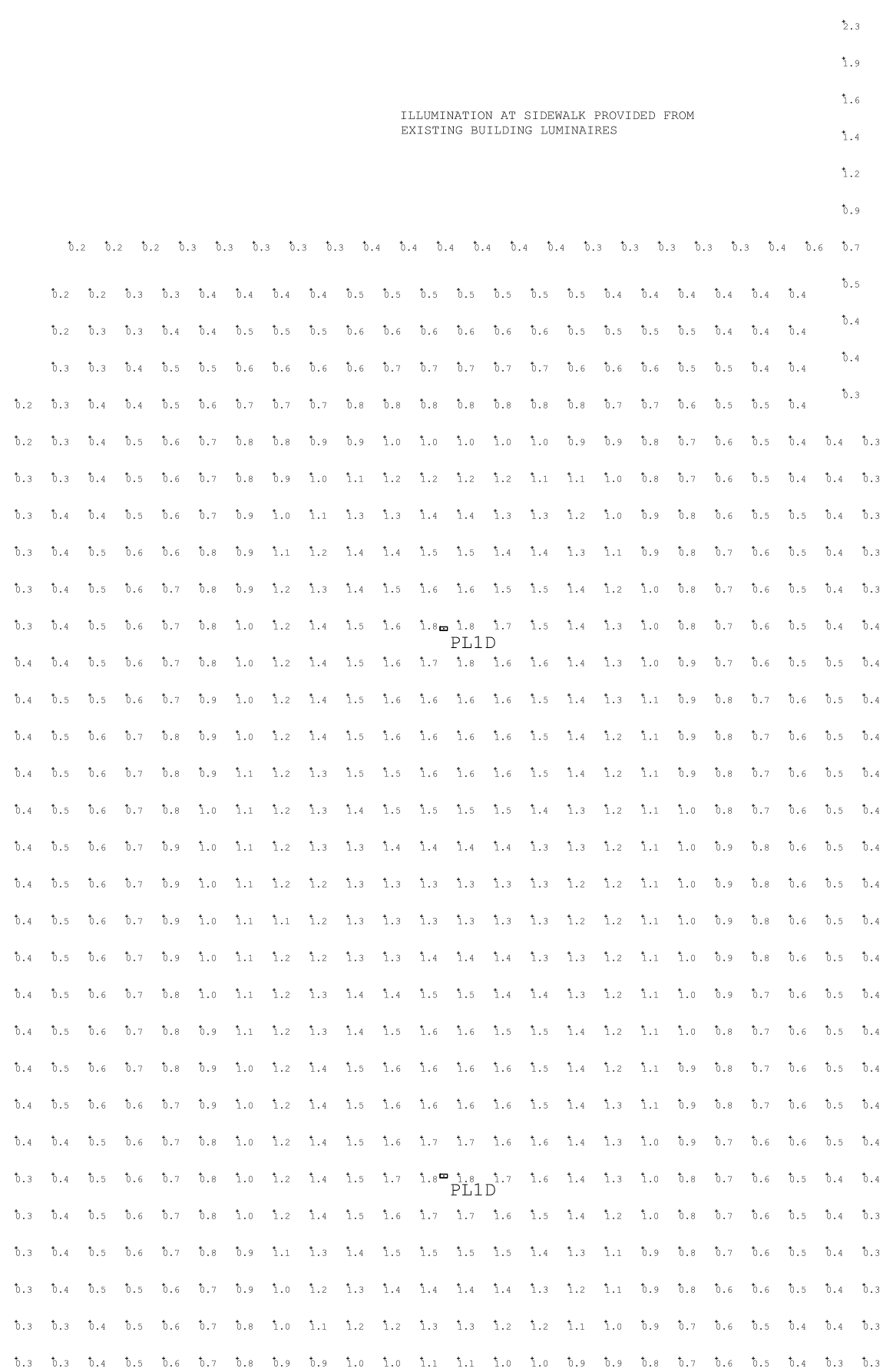

2.3
1.9
1.6
1.4
1.2
1.0
0.9

Symbol	Qty	Tag	Label	Arrangement	LLF	Lum. Watts
□	125	PG1	PG1 4VT2-LD4-4-DR-UNV-L8	SINGLE	0.900	38.1
□	6	PL1D	GLEON-AF-02-LED-E1-5WQ-7	SINGLE	0.900	113
□	2	PL2B	PL2B GLEON-AF-01-LED-E1-	SINGLE	0.900	59

Label	CalcType	Units	Avg	Max	Min	Avg/Min
Level 1 Open Parking	Illuminance	Fc	1.04	4.8	0.3	3.47
Level 1 Open Parking Drive	Illuminance	Fc	1.98	6.4	0.3	6.60
Level 1 Open Parking Sidewalk	Illuminance	Fc	1.11	3.8	0.2	5.55
Level 1 Open Parking South	Illuminance	Fc	0.89	1.8	0.2	4.45

Open Parking LPD
 Area = 34373 Sq.ft
 Total Watts = 452
 Lighting Power Density = 0.013 Watts/Sq.ft

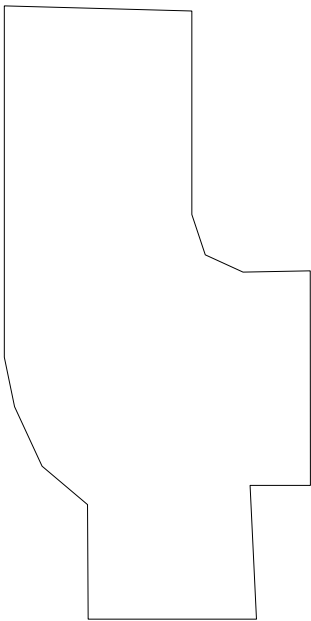

ENTERPRISE
Lighting & Control

imcmasters@enterpriselighting.com
 2007 Pewaukee Road
 Waukesha, WI 53188
 262-953-2700

1.2	1.3	1.4	1.6	1.7	1.7	1.6	1.5	1.4	1.3	1.1	1.1	1.0	1.0	1.0	1.1	1.1	1.2	1.4	1.5	1.6	1.7	1.8	1.8	1.7	1.6	1.6	1.6	1.6
1.2	1.3	1.5	1.6	1.7	1.7	1.6	1.5	1.4	1.3	1.1	1.1	1.0	1.0	1.0	1.1	1.1	1.2	1.4	1.5	1.6	1.7	1.8	1.8	1.7	1.6	1.7	1.6	1.7
1.1	1.3	1.4	1.5	1.6	1.6	1.5	1.5	1.4	1.3	1.1	1.0	1.0	1.0	1.0	1.1	1.2	1.4	1.5	1.6	1.6	1.7	1.7	1.6	1.6	1.6	1.6	1.6	1.7
1.1	1.2	1.3	1.4	1.4	1.4	1.4	1.4	1.3	1.2	1.1	1.0	1.0	1.0	1.0	1.1	1.2	1.3	1.4	1.5	1.5	1.5	1.5	1.6	1.6	1.6	1.6	1.6	1.9
1.0	1.1	1.2	1.3	1.4	1.4	1.3	1.3	1.2	1.1	1.0	1.0	1.0	1.0	1.0	1.1	1.2	1.3	1.4	1.5	1.5	1.5	1.5	1.5	1.5	1.6	1.7	2.0	2.0
0.9	1.0	1.1	1.2	1.2	1.2	1.2	1.1	1.1	1.1	1.0	0.9	0.9	0.9	0.9	1.0	1.1	1.1	1.2	1.3	1.4	1.4	1.4	1.4	1.5	1.8	2.3	3.4	3.4
0.8	0.9	0.9	1.0	1.0	1.0	1.0	1.0	1.0	1.0	0.9	0.9	0.9	0.9	0.9	1.0	1.0	1.0	1.1	1.2	1.3	1.3	1.4	1.5	1.7	2.4	4.3	4.3	4.3
0.7	0.7	0.8	0.8	0.8	0.8	0.8	0.8	0.8	0.8	0.8	0.8	0.8	0.8	0.8	0.9	0.9	0.9	1.0	1.1	1.2	1.3	1.4	1.5	1.7	2.4	4.8	4.8	4.8
0.6	0.6	0.6	0.7	0.7	0.7	0.7	0.7	0.7	0.7	0.7	0.7	0.7	0.7	0.7	0.7	0.7	0.8	0.8	0.9	1.1	1.3	1.4	1.5	1.6	1.8	2.2	4.1	4.1
0.5	0.5	0.6	0.6	0.6	0.6	0.6	0.6	0.6	0.6	0.6	0.6	0.6	0.6	0.6	0.6	0.6	0.7	0.7	0.7	0.9	1.2	1.5	1.5	1.6	1.9	2.1	2.3	2.6
0.4	0.4	0.5	0.5	0.5	0.5	0.5	0.5	0.5	0.5	0.5	0.5	0.5	0.5	0.5	0.5	0.6	0.6	0.6	0.6	0.9	1.3	1.6	1.7	1.8	2.0	2.1	2.4	3.8
0.3	0.4	0.4	0.4	0.4	0.4	0.4	0.4	0.4	0.4	0.4	0.4	0.4	0.4	0.4	0.5	0.5	0.5	0.5	0.5	0.7	1.3	1.8	1.8	1.8	2.0	2.1	2.4	3.9
0.3	0.3	0.3	0.3	0.3	0.3	0.3	0.3	0.3	0.3	0.3	0.3	0.4	0.4	0.4	0.4	0.4	0.4	0.5	0.6	1.3	1.9	1.9	1.9	2.0	2.1	2.3	3.6	3.6

ILLUMINATION AT SIDEWALK PROVIDED FROM EXISTING BUILDING LUMINAIRES

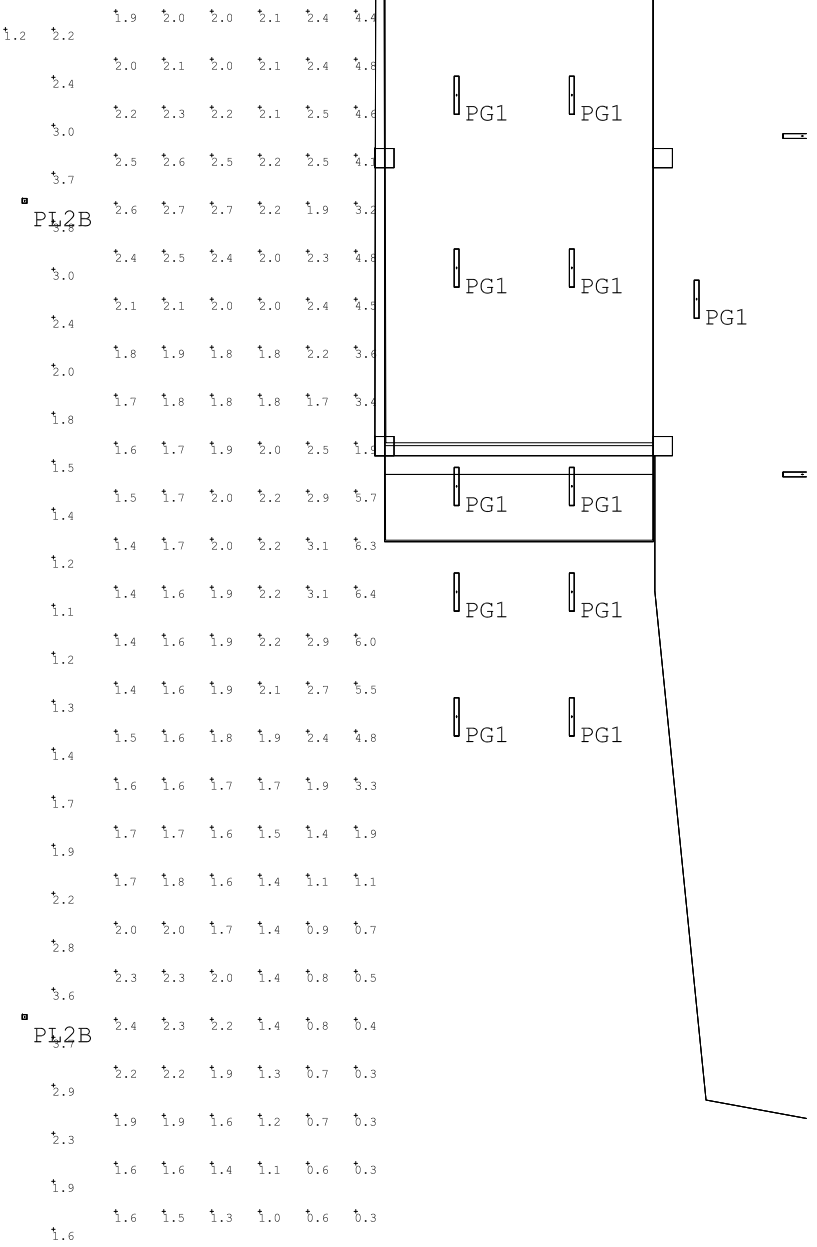

ENTERPRISE
Lighting & Control

imcmasters@enterpriselighting.com
2007 Pewaukee Road
Waukesha, WI 53188
262-953-2700

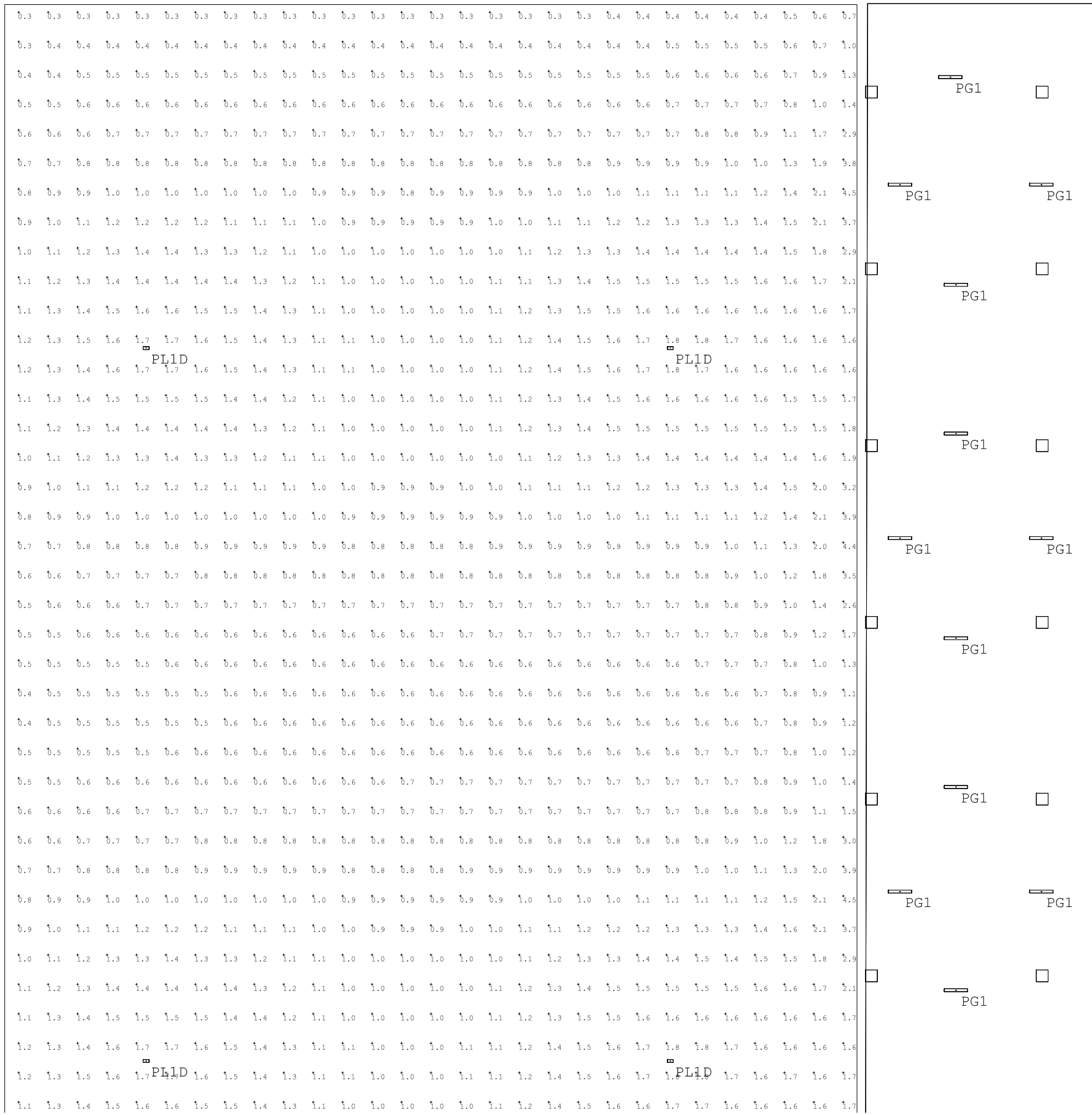

LEVEL 1

EXISTING WEST PARKING LOTS

WEST PLACE
Madison, WI

11/21/2016

Scale: 1" = 20'-0"



ENTERPRISE
Lighting & Control

imcmasters@enterpriselighting.com
2007 Pewaukee Road
Waukesha, WI 53188
262-953-2700

Luminaire Schedule						
Symbol	Qty	Tag	Label	Description	LLF	Lum. Watts
○	10	C1A	C1A_SLD606835WH	SURFACE MOUNT DOWNLIGHT	0.900	12.2
○	10	C1B	C1B_SLD612835WH	SURFACE MOUNT DOWNLIGHT	0.900	14.8
□	125	PG1	PG1_4VT2-LD4-4-DR-UNV-L8	SURFACE MOUNT VAPOR TIGHT	0.900	38.1
□	1	PL1B	GLEON-AF-02-LED-E1-SL3-7	TYPE III AREA LIGHT, 18' POLE ON RAISED BASE	0.900	113
□	2	PL1D	GLEON-AF-02-LED-E1-5WQ-7	TYPE V AREA LIGHT, 18' POLE ON RAISED BASE	0.900	113
□	17	PL2B	PL2B_GLEON-AF-01-LED-E1-	GLEON-AF-01-LED-E1-SL3-7030	0.900	59
□	4	PL2C	PL2C_GLEON-AF-01-LED-E1-	GLEON-AF-01-LED-E1-T4FT-7030	0.900	59
□	8	W1	W1_AMETRIX_ASYX-S-1-W-X-	WALL MOUNTED INDIRECT	0.900	54.7

Calculation Summary							
Label	CalcType	Units	Avg	Max	Min	Avg/Min	
Bldg 5 Center Stair landing Top	ILLUMINANCE	Fc	14.96	15.4	14.5	1.03	
Bldg 5 Center Stair Lower Side	ILLUMINANCE	Fc	7.37	10.7	4.7	1.57	
Bldg 5 Center Stair Upper Side	ILLUMINANCE	Fc	16.53	19.1	13.8	1.20	
Bldg 5 stoop 1 Top	ILLUMINANCE	Fc	3.50	4.3	0.7	5.00	
Bldg 5 stoop 2 Top	ILLUMINANCE	Fc	3.09	4.3	0.7	4.41	
Bldg 5 stoop 4 Top	ILLUMINANCE	Fc	0.83	1.6	0.3	2.77	
Bldg 5 stoop 5 Top	ILLUMINANCE	Fc	3.02	4.5	0.1	30.20	
Bldg 5 stoop 6 Top	ILLUMINANCE	Fc	3.41	4.6	0.1	34.10	
Bldg 5 stoop 7 Top	ILLUMINANCE	Fc	3.44	4.7	0.5	6.88	
Bldg 5 stoop Top	ILLUMINANCE	Fc	3.43	4.4	0.8	4.29	
Bldge 5 Parking Passage Center	ILLUMINANCE	Fc	7.93	10.2	5.3	1.50	
Bldge 5 Parking Passage North	ILLUMINANCE	Fc	5.93	7.3	3.7	1.60	
Bldge 5 Parking Passage South	ILLUMINANCE	Fc	5.09	8.4	2.1	2.42	
G1 Parking Bldg 5 Floor	ILLUMINANCE	Fc	7.44	16.9	2.0	3.72	
Ramp to P1 Parking Bldge 5 Side	ILLUMINANCE	Fc	9.71	16.4	5.2	1.87	

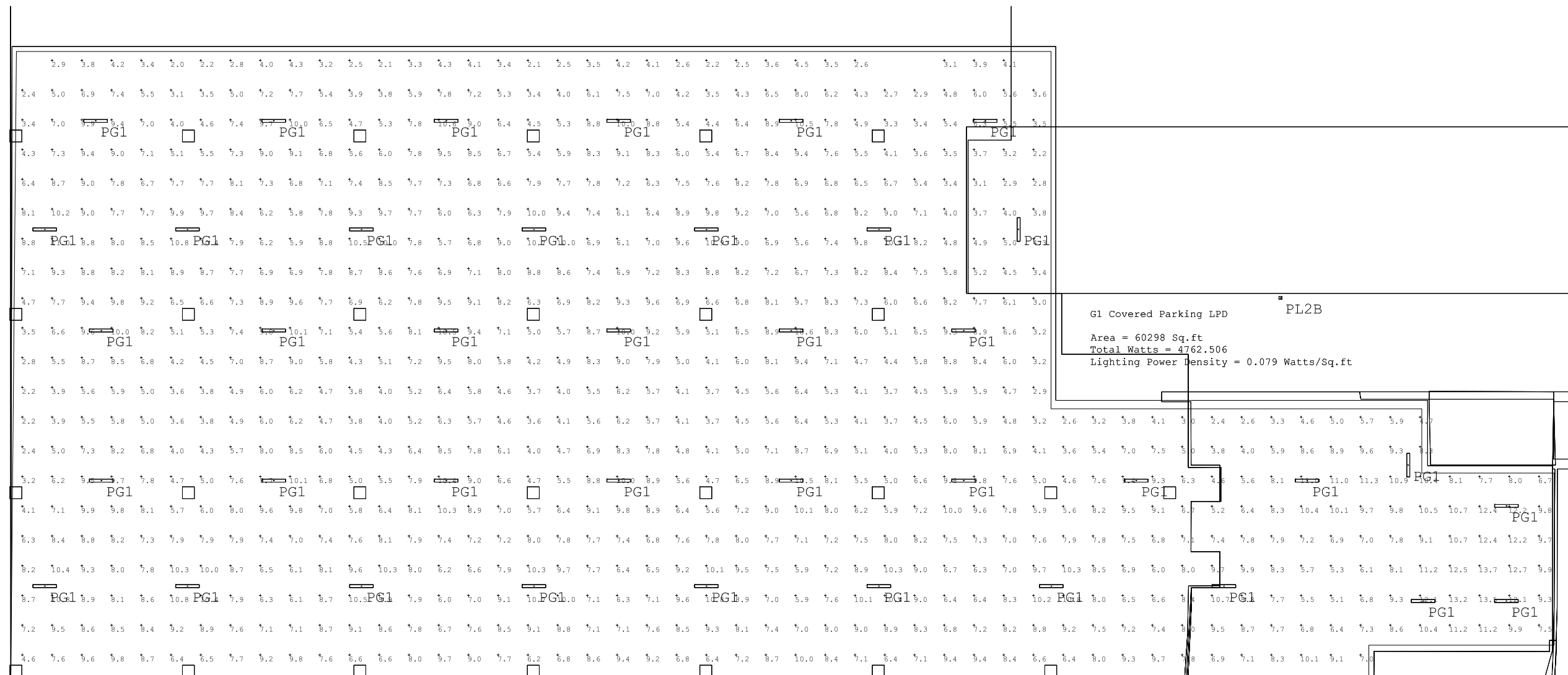

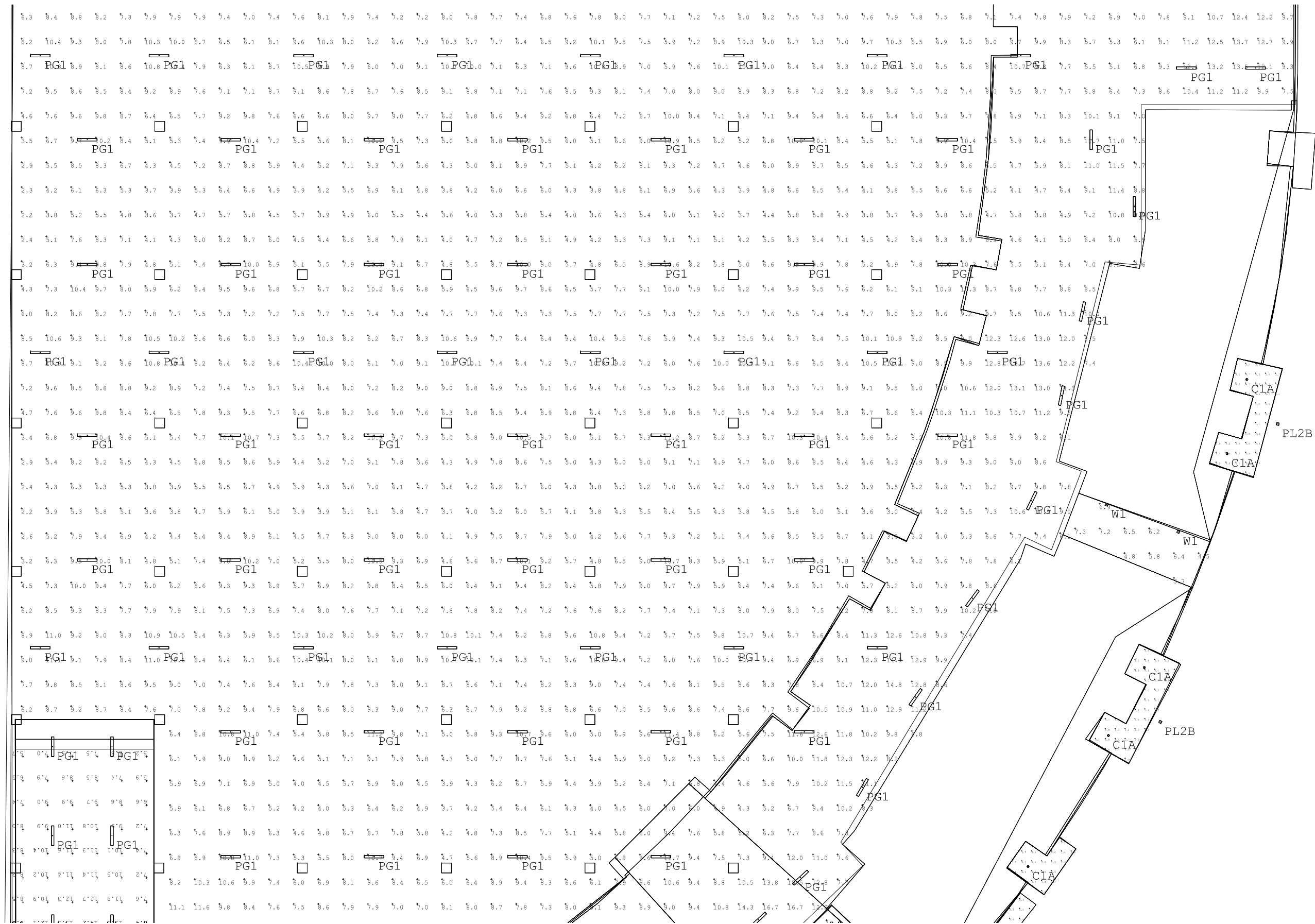

LEVEL 1

BLDG. 5

WEST PLACE
Madison, WI

11/21/2016

Scale: 1" = 20'-0"



ENTERPRISE
Lighting & Control

imcmasters@enterpriselighting.com
2007 Pewaukee Road
Waukesha, WI 53188
262-953-2700

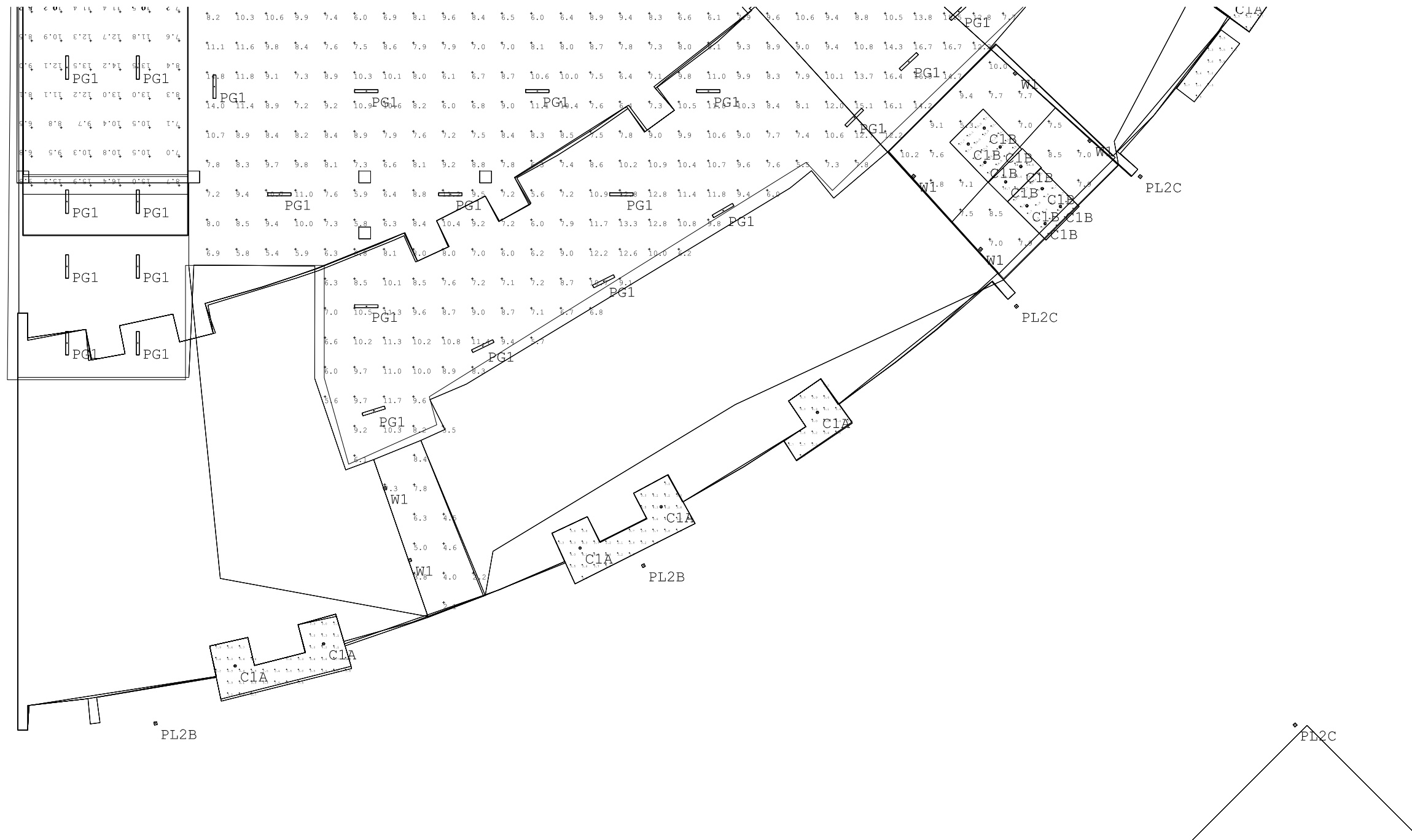

LEVEL 1

BLDG. 5

WEST PLACE
Madison, WI

11/21/2016

Scale: 1" = 20'-0"



ENTERPRISE
Lighting & Control

imcmasters@enterpriselighting.com
2007 Pewaukee Road
Waukesha, WI 53188
262-953-2700

Luminaire Schedule						
Symbol	Qty	Tag	Label	Description	LLF	Lum. Watts
○	10	C1A	C1A SLD606835WH	SURFACE MOUNT DOWNLIGHT	0.900	12.2
○	62	C1B	C1B SLD612835WH	SURFACE MOUNT DOWNLIGHT	0.900	14.8
○	42	C2	C2 ML4D09NFL930-TIR50NFL	ML4D09NFL930-TIR50NFL25-TL43R2G X TL44S2GX	0.900	11.5
□	1	PL1B	GLEON-AF-02-LED-E1-SL3-7	TYPE III AREA LIGHT, 18' POLE ON RAISED BASE	0.900	113
□	18	PL2B	PL2B GLEON-AF-01-LED-E1-	GLEON-AF-01-LED-E1-SL3-7030	0.900	59
□	4	PL2C	PL2C GLEON-AF-01-LED-E1-	GLEON-AF-01-LED-E1-T4FT-7030	0.900	59
□	336	S	S TIVOLI LSLB06S39C12	LSLB06S39C12	0.900	0.51
□	4	SL1	SL1 FC5L550-LED	RECESSED WALL STEPLIGHT	0.900	6
□	26	SL2	SL2 COLE I392D L11136307	C1392D-LED-2	0.900	2.61
□	25	W1	W1 AMETRIX ASYX-S-1-W-X-	WALL MOUNTED INDIRECT	0.900	54.7
□	10	W2	W2 Luminaire LED AOV13-1	AOV13-15W 4000K CP	0.900	13.5
□	27	W3	W3 FCC410W-D-90	WALL MOUNTED DOWNLIGHT	0.900	42.8

Calculation Summary						
Label	CalcType	Units	Avg	Max	Min	Avg/Min
Bike Parking	Illuminance	Fc	0.70	0.9	0.5	1.40
Bike Parking 1	Illuminance	Fc	1.08	1.4	0.7	1.54
Gammon Road Sidewalk	Illuminance	Fc	0.24	0.9	0.0	N.A.
Ll Bldgs 1 & 2 Dining	Illuminance	Fc	2.09	4.7	0.5	4.18
Ll Bldgs 3 & 4 Dining	Illuminance	Fc	2.04	6.0	0.5	4.08
Ll Central Plaza	Illuminance	Fc	0.70	5.5	0.0	N.A.
Lighting Beyond Public Sidewalk	Illuminance	Fc	0.11	0.8	0.0	N.A.
Mineral Point Road Sidewalk	Illuminance	Fc	0.37	1.1	0.0	N.A.
Terrace Stairs	Illuminance	Fc	1.65	1.9	1.4	1.18
Terrace Stairs 1	Illuminance	Fc	1.93	2.2	1.7	1.14
Terrace Stairs 2	Illuminance	Fc	1.20	1.2	1.2	1.00
Terrace Stairs 3	Illuminance	Fc	1.15	3.2	0.2	5.75
Terrace Stairs 4	Illuminance	Fc	1.24	2.1	0.3	4.13
Terrace Stairs 5	Illuminance	Fc	1.57	2.3	1.1	1.43
Terrace Stairs 6	Illuminance	Fc	1.33	3.2	0.8	1.66

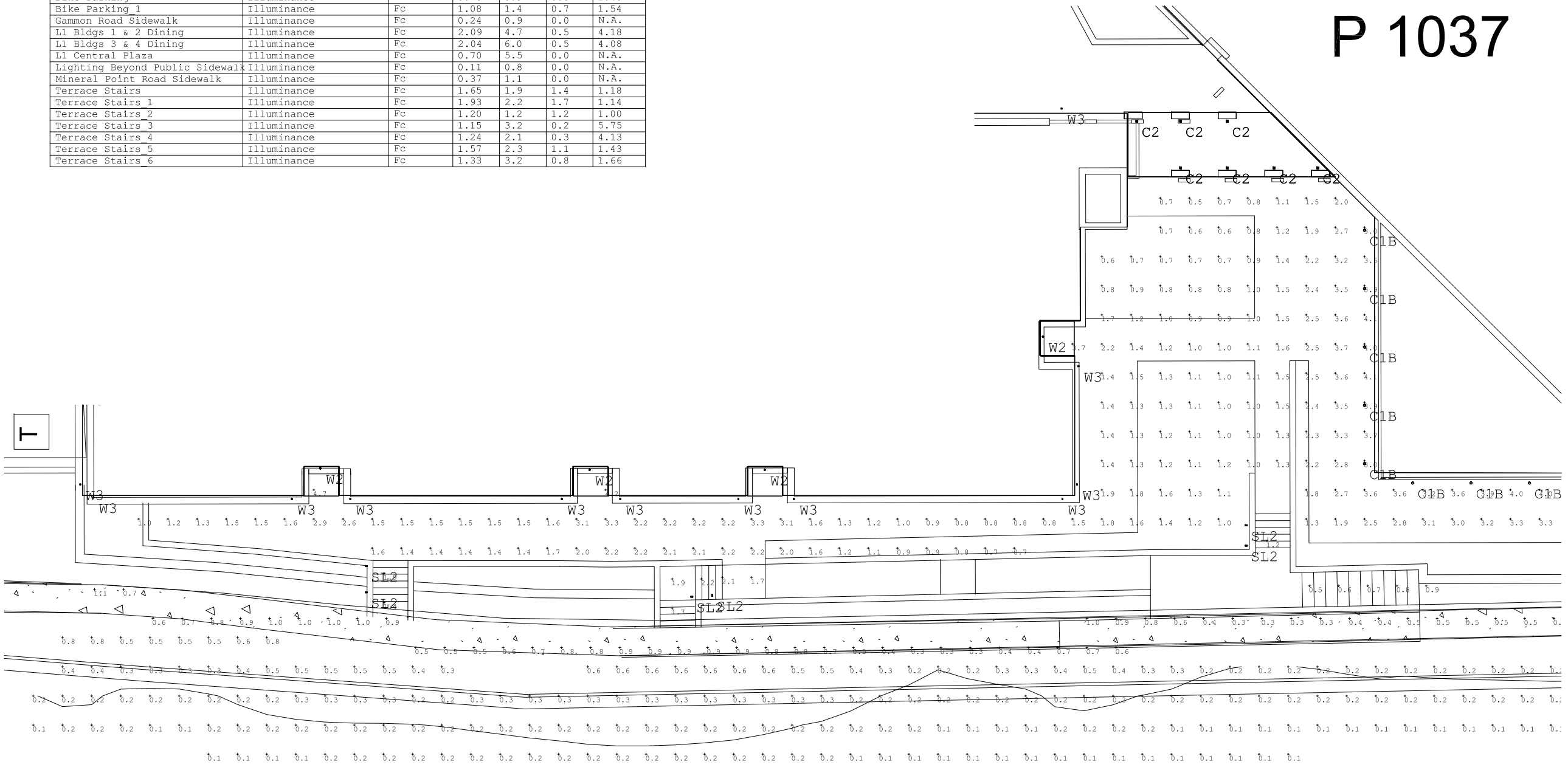

LEVEL 1

BLDGS. 1 TO 4 & TERRACE

WEST PLACE
Madison, WI

11/21/2016

Scale: 1" = 20'-0"

ENTERPRISE
Lighting & Control

imcmasters@enterpriselighting.com
2007 Pewaukee Road
Waukesha, WI 53188
262-953-2700

FL 1048 P 1037

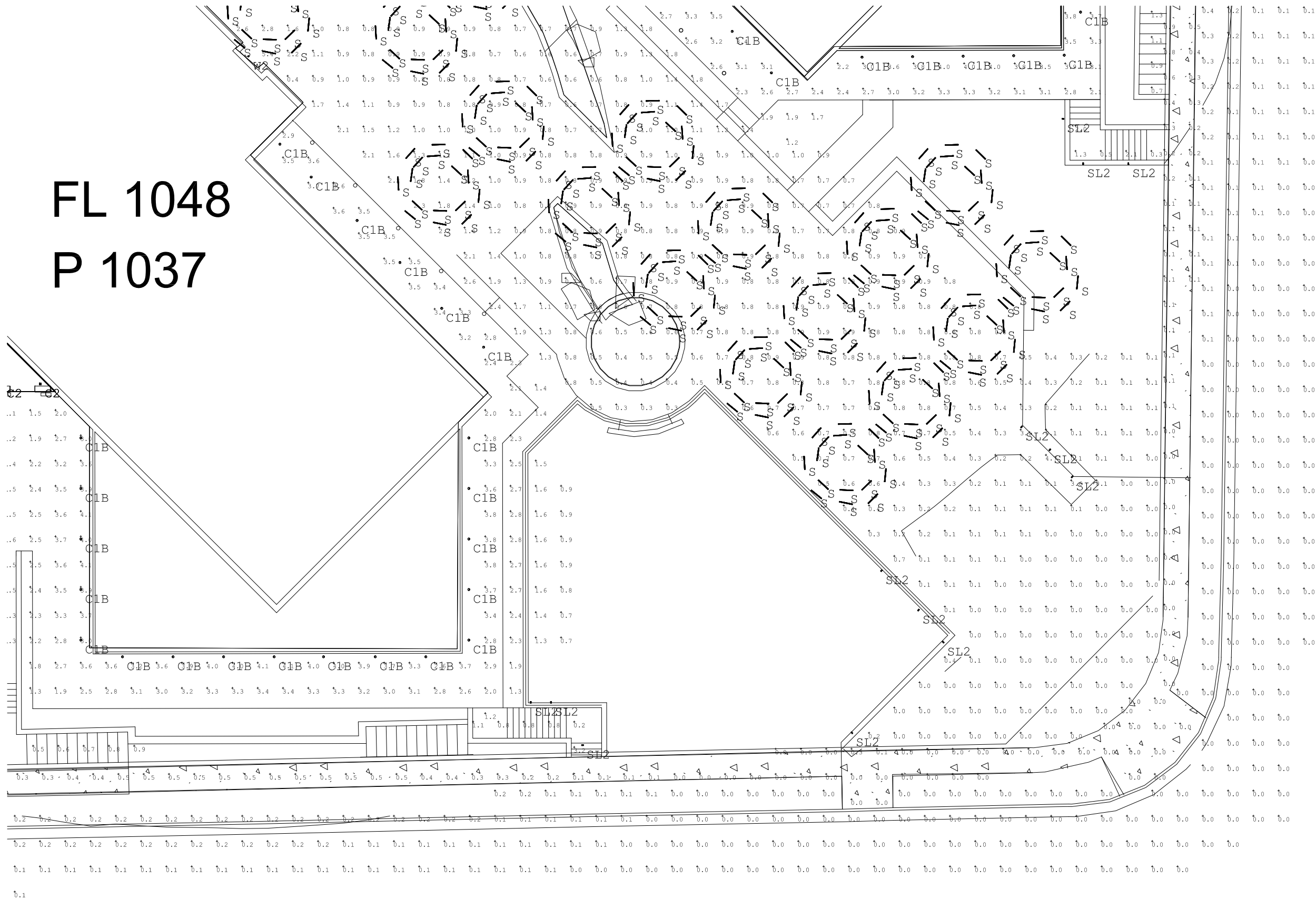

LEVEL 1

BLDGS. 1 TO 4 & TERRACE

WEST PLACE
Madison, WI

11/21/2016

Scale: 1" = 20'-0"



ENTERPRISE
Lighting & Control

imcmasters@enterpriselighting.com

2007 Pewaukee Road
Waukesha, WI 53188
262-953-2700

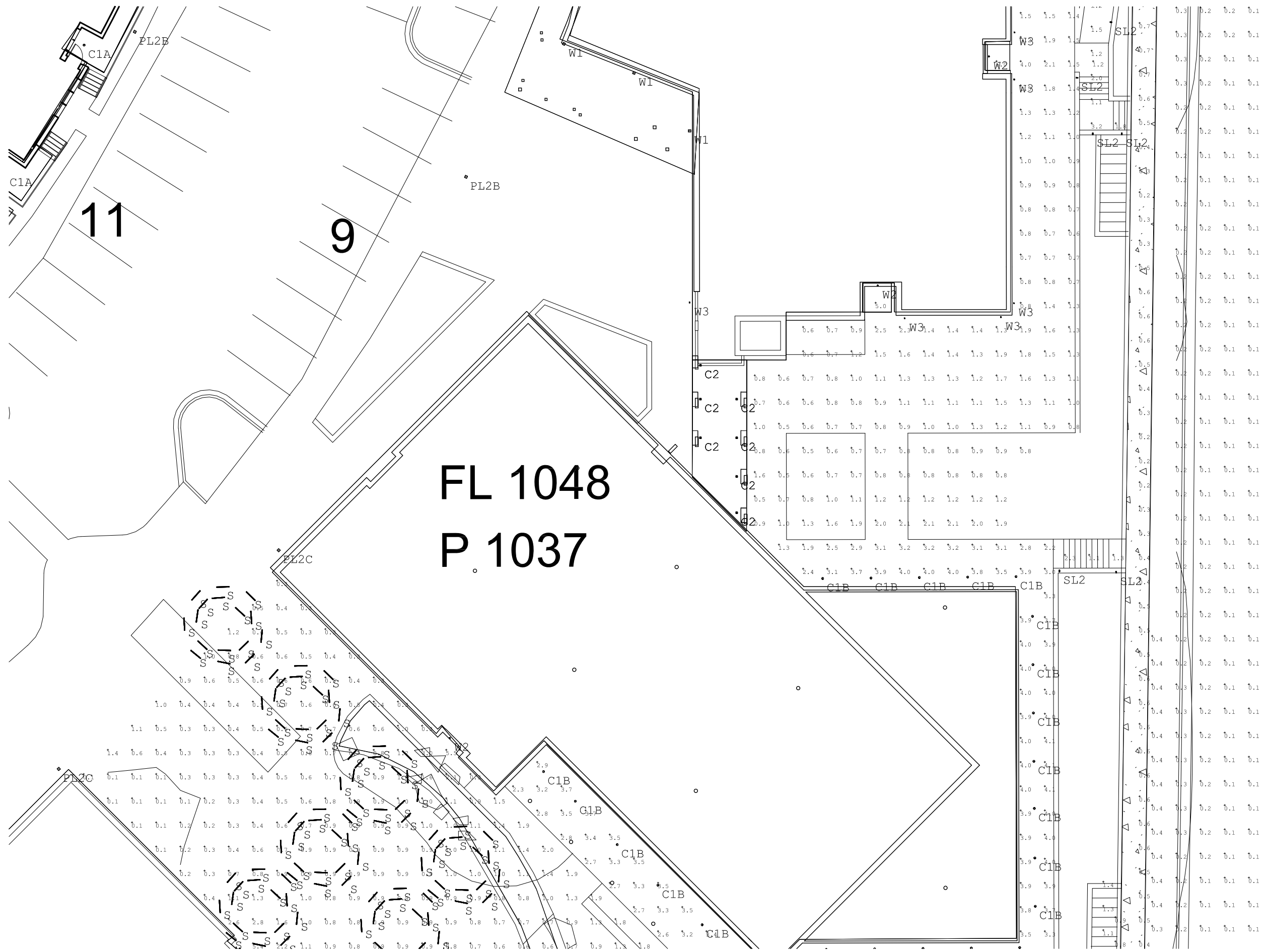

LEVEL 1

BLDGS. 1 TO 4 & TERRACE

WEST PLACE
Madison, WI

11/21/2016

Scale: 1" = 20'-0"



ENTERPRISE
Lighting & Control

imcmasters@enterpriselighting.com

2007 Pewaukee Road
Waukesha, WI 53188
262-953-2700

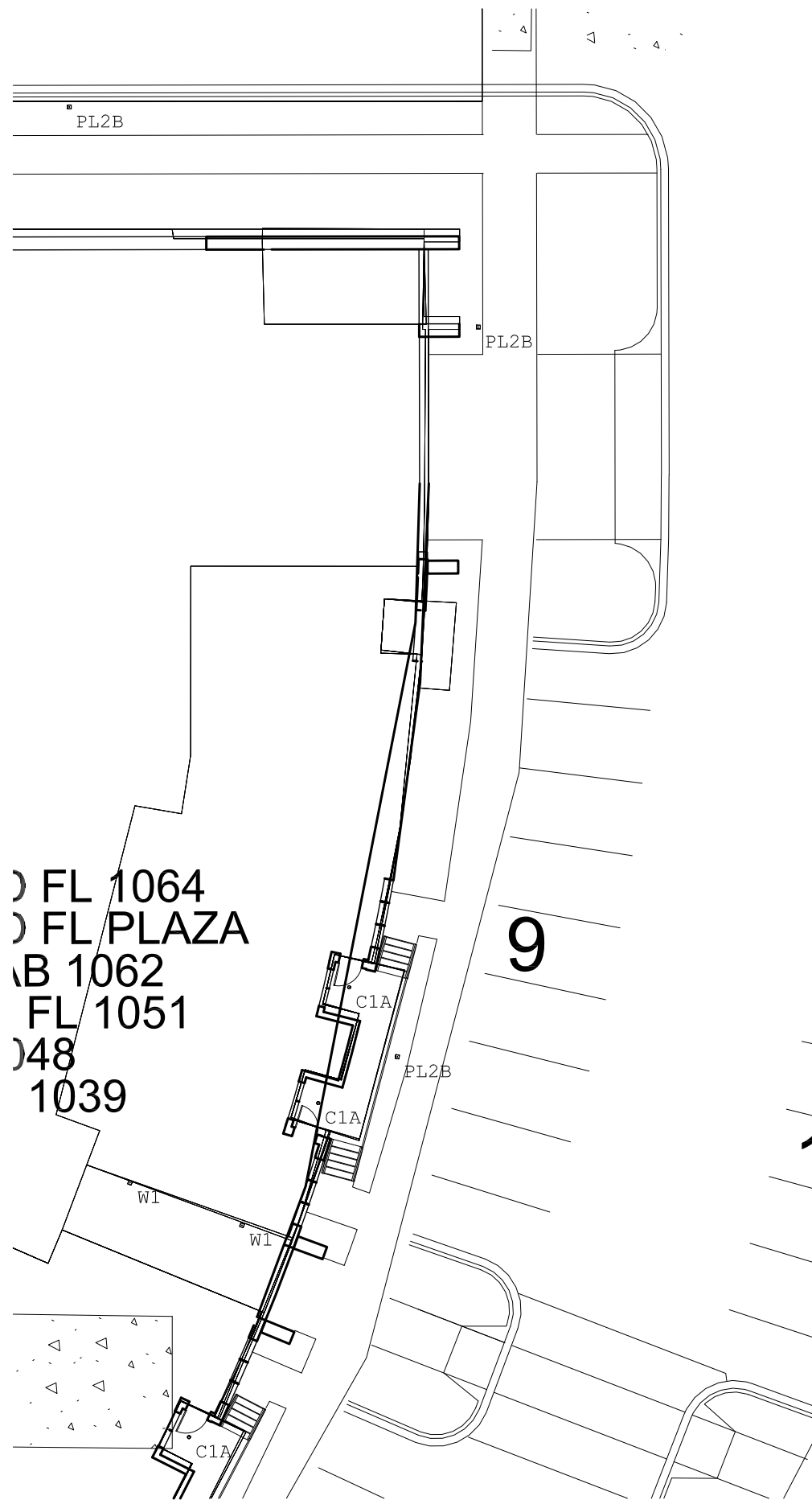

LEVEL 1

BLDGS. 1 TO 4 & TERRACE

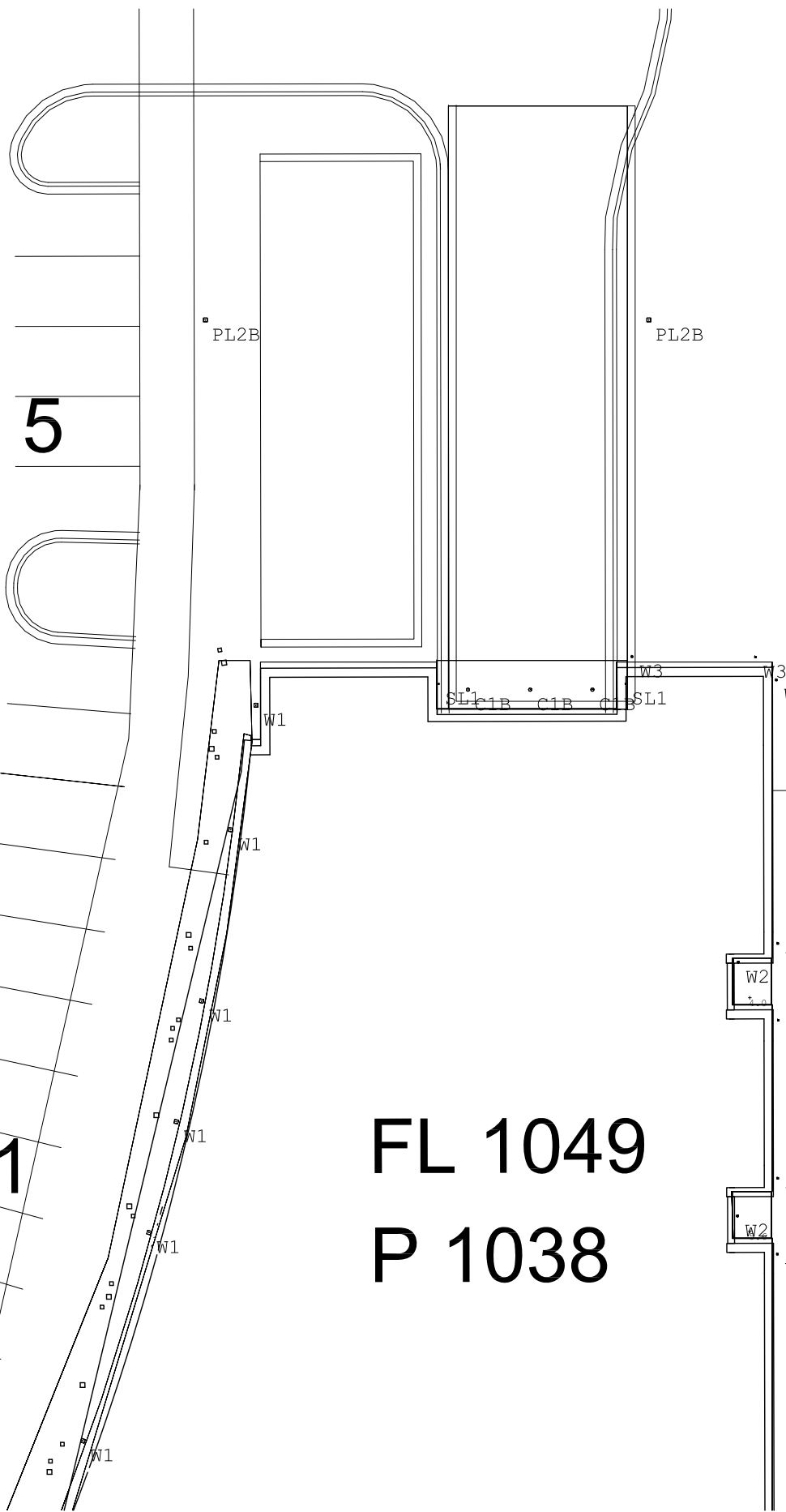

FL 1049
P 1038

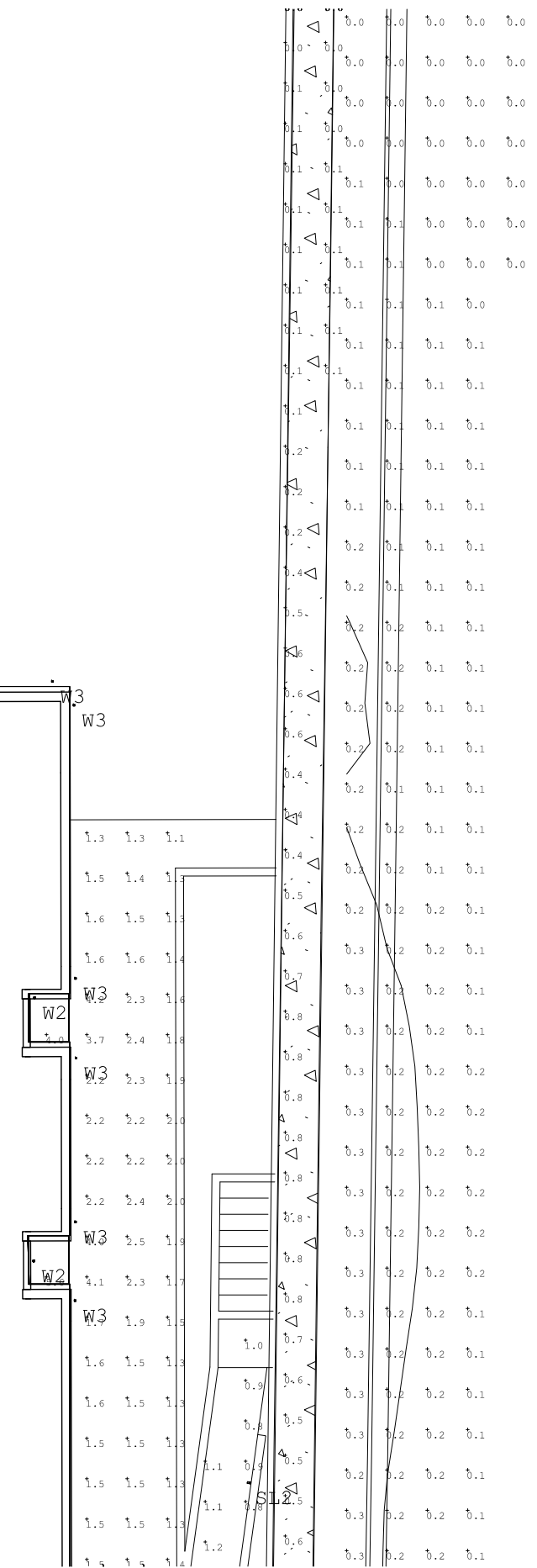

WEST PLACE
Madison, WI

11/21/2016

Scale: 1" = 20'-0"



imcmasters@enterpriselighting.com

2007 Pewaukee Road

Waukesha, WI 53188

262-953-2700

Luminaire Schedule						
Symbol	Qty	Tag	Label	Description	LLF	Lum. Watts
⊙	8	C1A	C1A_SLD606835WH	SURFACE MOUNT DOWNLIGHT	0.900	12.2
⊙	12	C1B	C1B_SLD612835WH	SURFACE MOUNT DOWNLIGHT	0.900	14.8
⊙	14	C2	C2_ML4D09NFL930-TIR50NFL	ML4D09NFL930-TIR50NFL25-TL43R2G X TL44S2GX	0.900	11.5
⊙	336	S	S_TIVOLI_LSLB06S39C12	LSLB06S39C12	0.900	0.51
⊙	24	W3	W3_FCC410W-D-90	WALL MOUNTED DOWNLIGHT	0.900	42.8
⊙	20	W5	W5_3450-2XLED_6	PLATE OUT 3450 2XLED.6	0.900	10.89

Calculation Summary						
Label	CalcType	Units	Avg	Max	Min	Avg/Min
Bldg 1-2 catwalk Top	Illuminance	Fc	13.57	21.9	2.6	5.22
Bldg 3-4 catwalk 1 Top	Illuminance	Fc	14.54	25.2	2.8	5.19
Level 2 Balcony 1 1 Top 1	Illuminance	Fc	2.30	2.8	1.6	1.44
Level 2 Balcony 1 2 Top 1	Illuminance	Fc	2.33	2.6	2.0	1.17
Level 2 Balcony 1 3 Top 1	Illuminance	Fc	2.43	2.9	1.8	1.35
Level 2 Balcony 1 Top 1	Illuminance	Fc	2.30	2.5	2.1	1.10
lPl Bldg 2 1 Top	Illuminance	Fc	0.13	0.3	0.0	N.A.
lPl Bldg 2 Top	Illuminance	Fc	0.19	0.6	0.0	N.A.

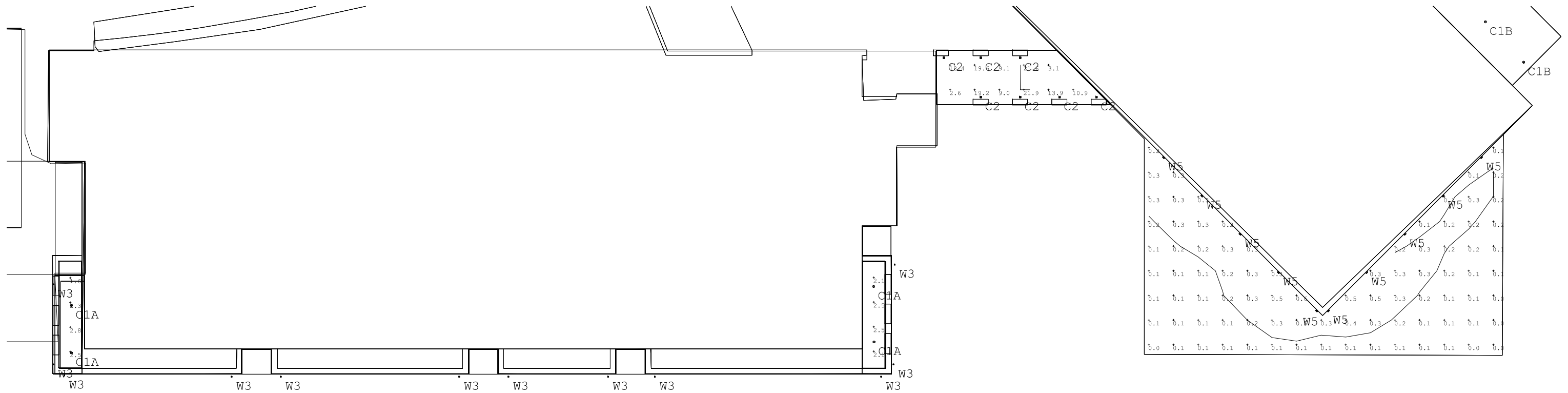

LEVEL 2

BLDG. 1 TO 4

WEST PLACE
Madison, WI

11/21/2016

Scale: 1" = 20'-0"



ENTERPRISE
Lighting & Control

imcmasters@enterpriselighting.com
2007 Pewaukee Road
Waukesha, WI 53188
262-953-2700

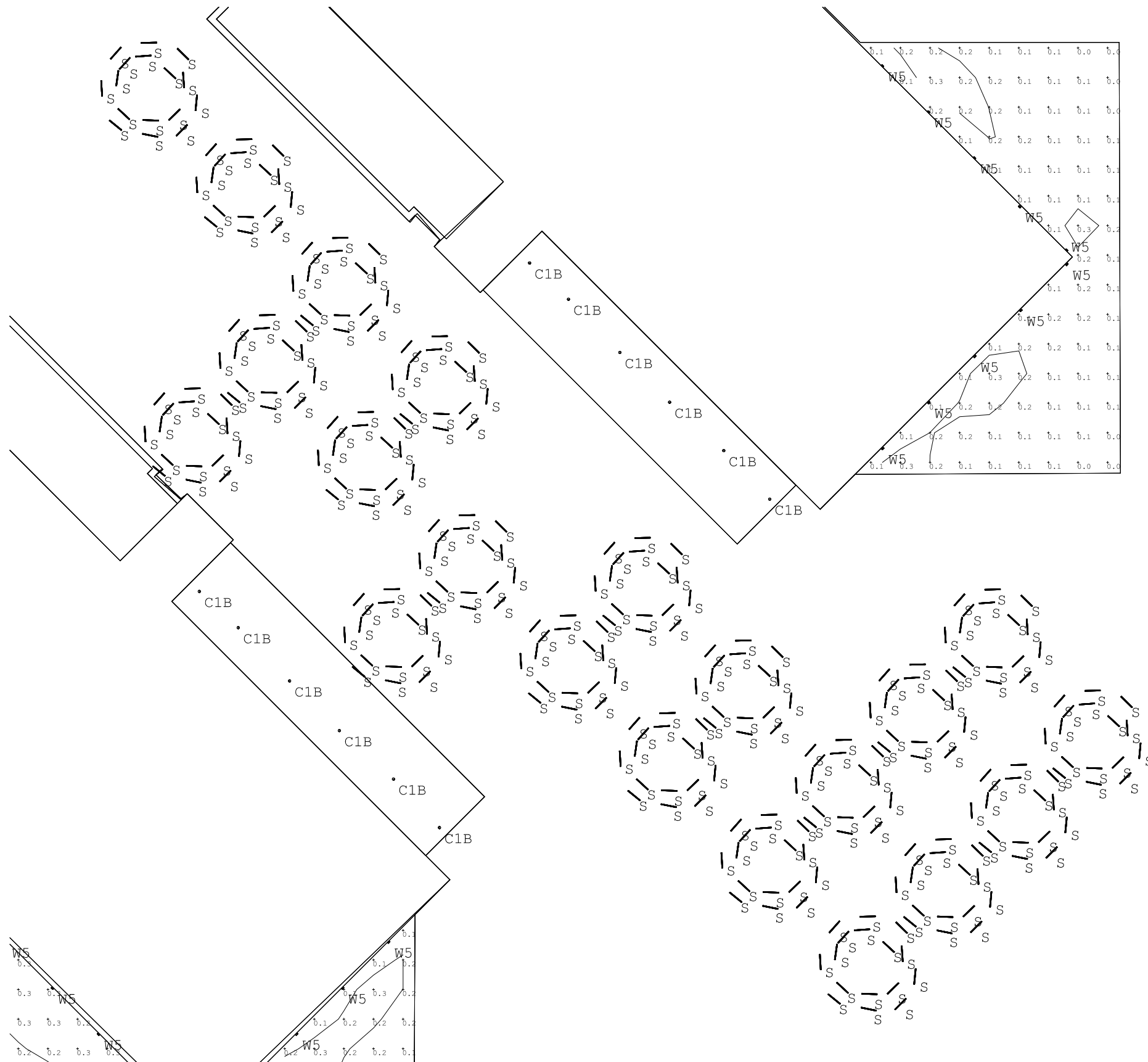

LEVEL 2

BLDGS. 1 TO 4

WEST PLACE
Madison, WI

11/21/2016

Scale: 1" = 20'-0"



ENTERPRISE
Lighting & Control

imcmasters@enterpriselighting.com
2007 Pewaukee Road
Waukesha, WI 53188
262-953-2700

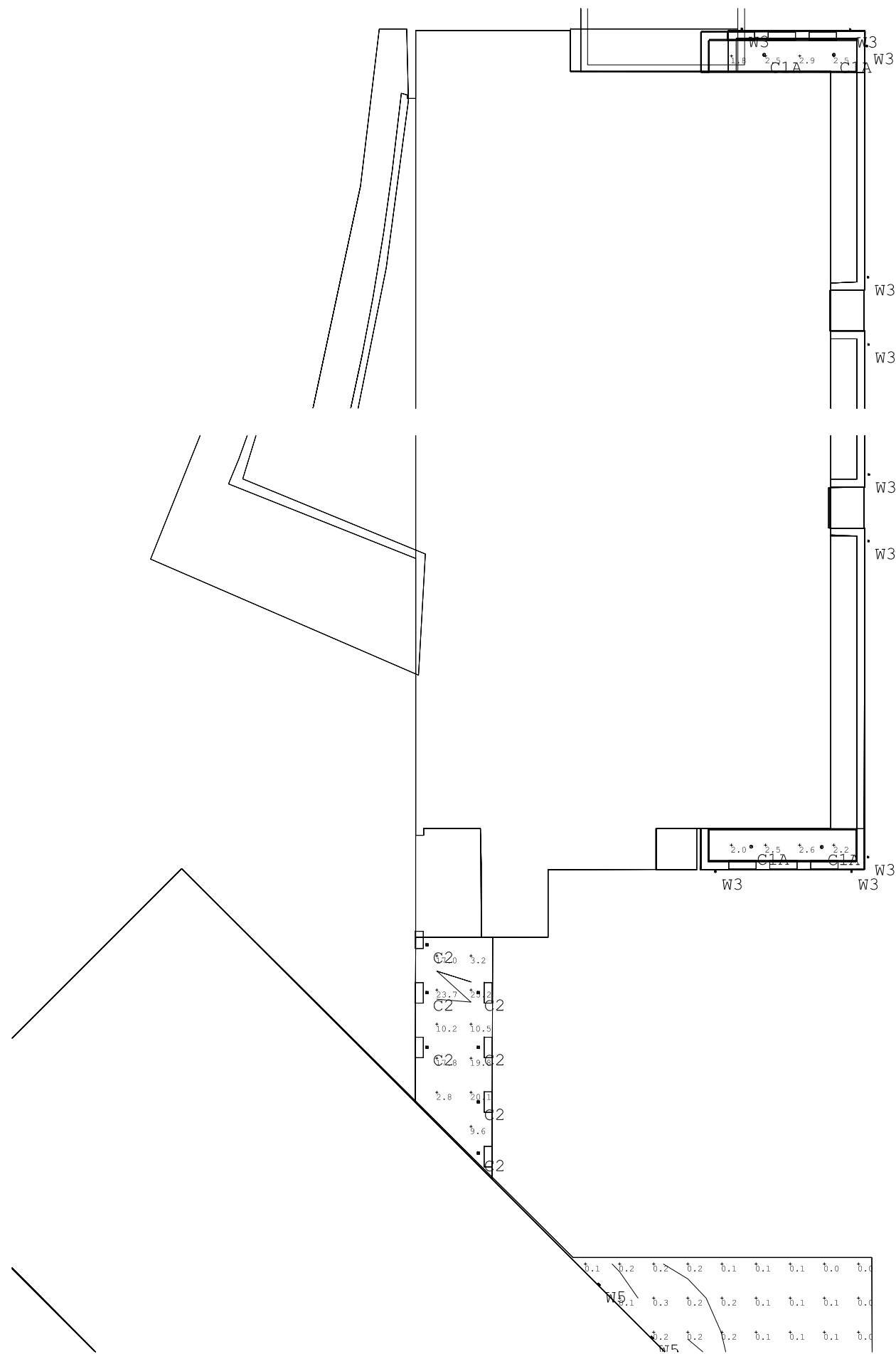

LEVEL 2

BLDGS. 1 TO 4

WEST PLACE
Madison, WI

11/21/2016

Scale: 1" = 20'-0"



imcmasters@enterpriselighting.com
 2007 Pewaukee Road
 Waukesha, WI 53188
 262-953-2700

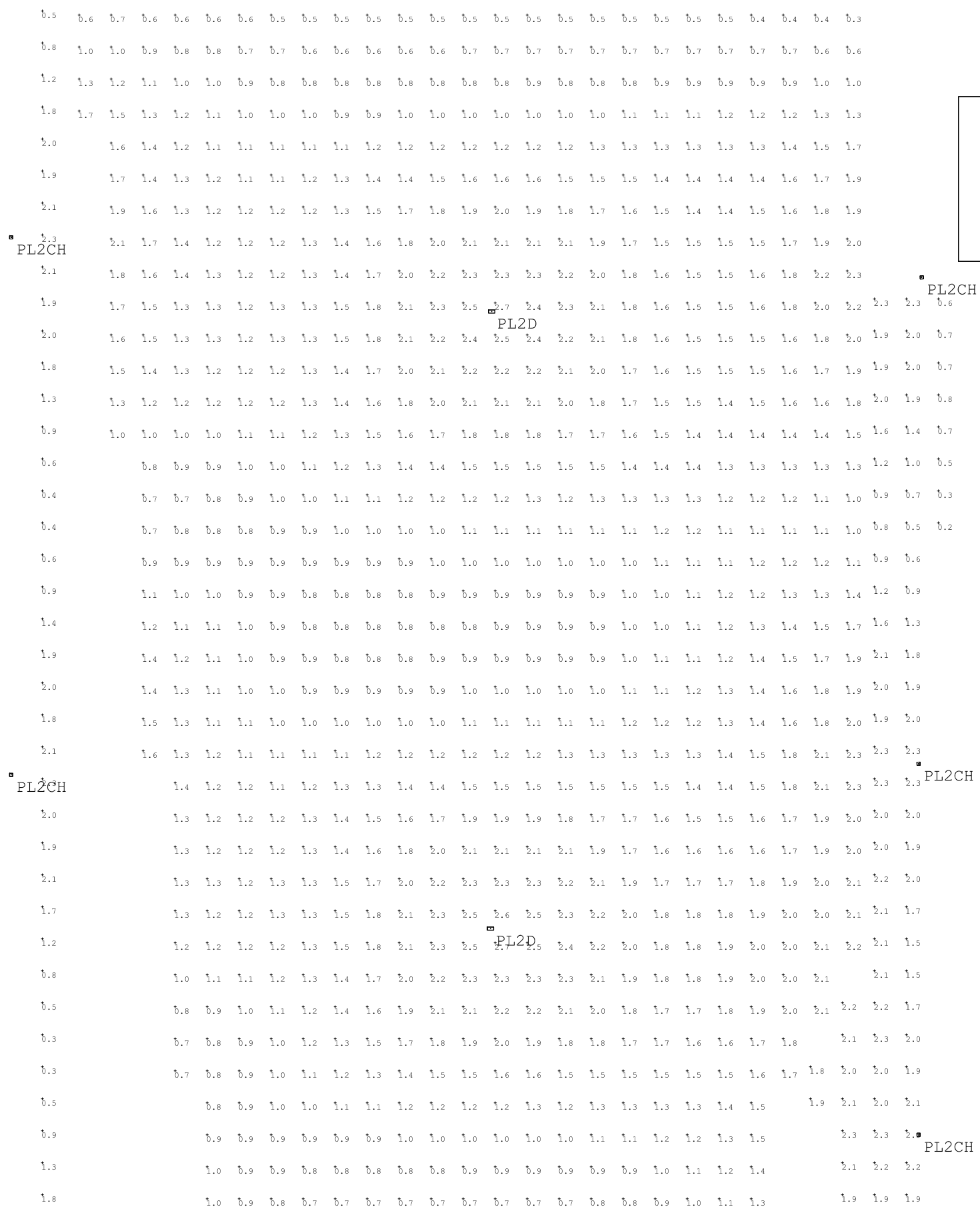

Luminaire Schedule						
Symbol	Qty	Tag	Label	Description	LLF	Lum. Watts
□	7	PL2CH	PL2CH GLEON-AF-01-LED-E1	GLEON-AF-01-LED-E1-SL4-7030-HSS	0.900	59
□	2	PL2D	PL2D GLEON-AF-02-LED-E1-	GLEON-AF-02-LED-E1-5WQ-7030	0.900	113
□	23	SL1	SL1 FC SL550-LED	RECESSED WALL STEPLIGHT	0.900	6
□	8	W1	W1 AMETRIX ASYX-S-1-W-X-	WALL MOUNTED INDIRECT	0.900	54.7

Calculation Summary							
Label	CalcType	Units	Avg	Max	Min	Avg/Min	
Center Passage Second Floor	Illuminance	Fc	6.15	8.2	1.7	3.62	
Level 2 Building 5 balconies 1	Illuminance	Fc	0.47	5.7	0.0	N.A.	
Level 2 Building 5 balconies 2	Illuminance	Fc	0.42	3.6	0.0	N.A.	
Level 2 Building 5 balconies 3	Illuminance	Fc	0.40	3.1	0.0	N.A.	
Level 2 Building 5 balconies 4	Illuminance	Fc	0.51	5.4	0.0	N.A.	
Level 2 Building 5 balconies 5	Illuminance	Fc	0.45	6.6	0.0	N.A.	
Level 2 Building 5 Balconies Top	Illuminance	Fc	0.40	3.7	0.0	N.A.	
Level 2 Building 5 balconies Top	Illuminance	Fc	0.37	4.6	0.0	N.A.	
Level 2 Open Parking	Illuminance	Fc	1.35	2.7	0.3	4.50	
Level 2 Patios	Illuminance	Fc	0.58	5.2	0.0	N.A.	
Level 2 Patios 1	Illuminance	Fc	0.24	1.8	0.0	N.A.	
Level 2 Patios 2	Illuminance	Fc	0.38	1.3	0.0	N.A.	
Level 2 Patios 3	Illuminance	Fc	0.48	1.0	0.2	2.40	
Level 2 Patios 4	Illuminance	Fc	0.25	1.4	0.0	N.A.	
Level 2 Patios 5	Illuminance	Fc	0.50	4.9	0.0	N.A.	
Level 2 Patios 6	Illuminance	Fc	0.20	1.0	0.0	N.A.	
Level 2 walkways	Illuminance	Fc	1.20	2.5	0.2	6.00	

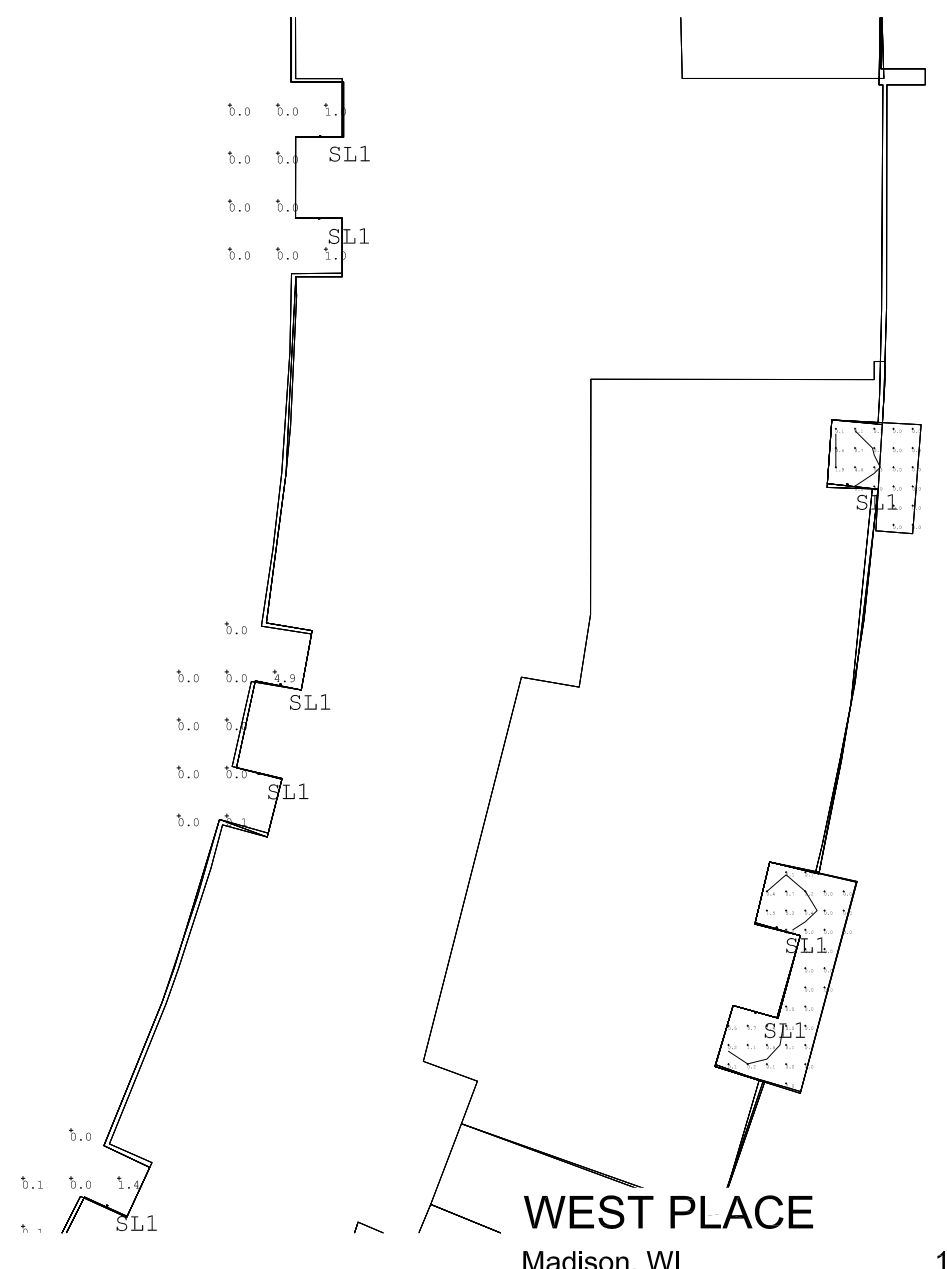

Scale: 1" = 20'-0"

ENTERPRISE
Lighting & Control

imcmasters@enterpriselighting.com

2007 Pewaukee Road
Waukesha, WI 53188
262-953-2700

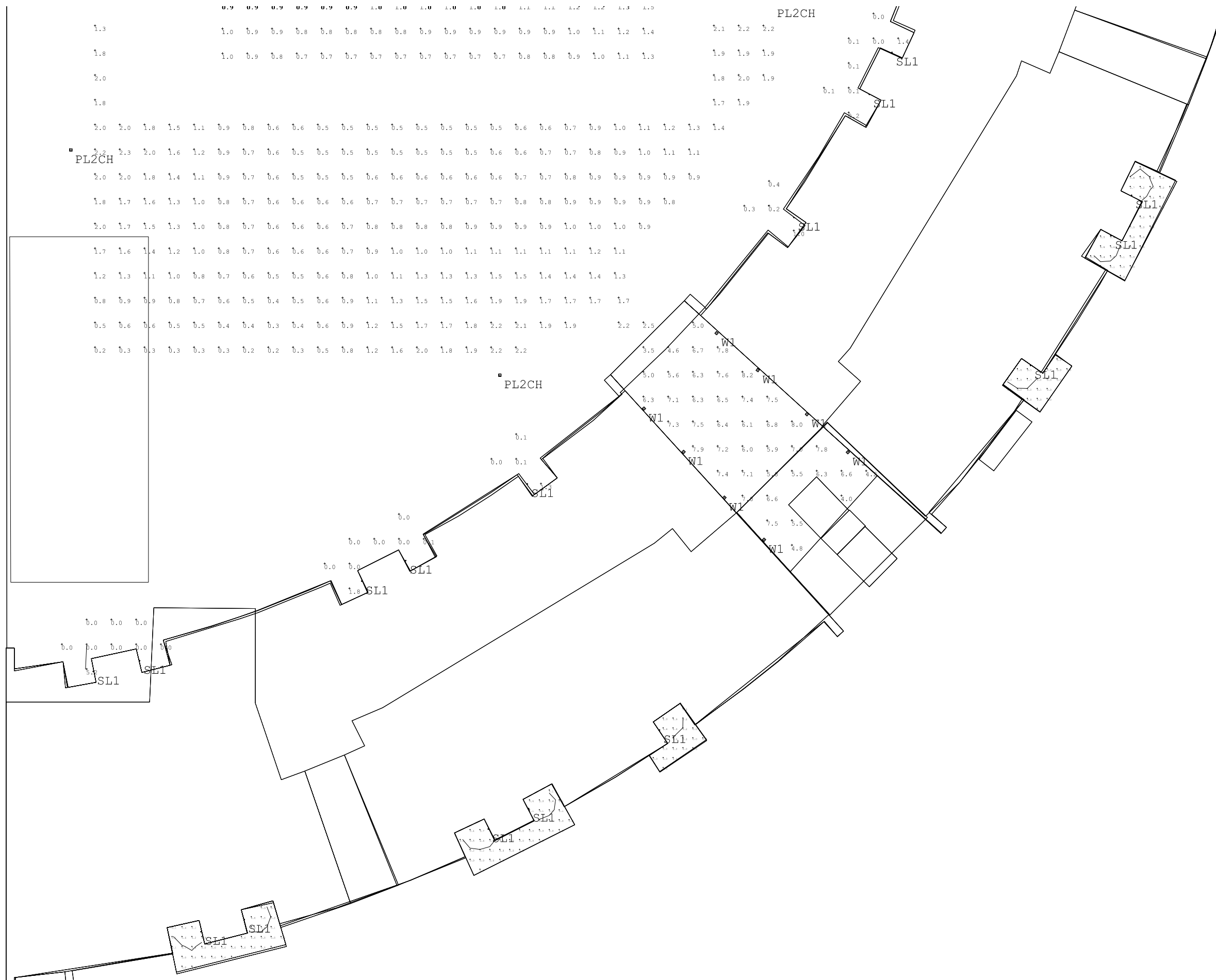

LEVEL 2

BLDG. 5

WEST PLACE
Madison, WI

11/21/2016

Scale: 1" = 20'-0"

 **ENTERPRISE**
Lighting & Control

imcmasters@enterpriselighting.com
2007 Pewaukee Road
Waukesha, WI 53188
262-953-2700

Luminaire Schedule						
Symbol	Qty	Tag	Label	Description	LLF	Lum. Watts
□	14	C2	C2 ML4D09NFL930-TIR50NFL	ML4D09NFL930-TIR50NFL25-TL43R2G X TL44S2GX	0.900	11.5
□	54	SL1	SL1 FCSL550-LED	RECESSED WALL STEPLIGHT	0.900	6
□	24	W3	W3 FCC410W-D-90	WALL MOUNTED DOWNLIGHT	0.900	42.8

Calculation Summary						
Label	CalcType	Units	Avg	Max	Min	Avg/Min
Bldg 1-2 catwalk 1 Top	Illuminance	Fc	13.32	25.2	1.2	11.10
Bldg 3-4 catwalk 1 1 Top	Illuminance	Fc	14.75	30.4	1.5	9.83
Building 1 balconies 1 Top	Illuminance	Fc	1.79	3.6	0.0	N.A.
Building 1 balconies 2 Top	Illuminance	Fc	0.98	2.2	0.0	N.A.
Building 1 balconies 3 Top	Illuminance	Fc	0.88	2.7	0.0	N.A.
Building 1 balconies Top	Illuminance	Fc	1.20	3.4	0.0	N.A.
Building 2 balcony Top	Illuminance	Fc	0.00	0.0	0.0	N.A.
Building 2 balcony Top	Illuminance	Fc	0.50	2.2	0.0	N.A.
Building 3 balcony Top	Illuminance	Fc	0.58	2.5	0.0	N.A.
Building 4 balconies 1 Top	Illuminance	Fc	1.58	3.6	0.0	N.A.
Building 4 balconies 2 Top	Illuminance	Fc	0.80	1.8	0.0	N.A.
Building 4 balconies 3 Top	Illuminance	Fc	1.31	3.6	0.0	N.A.
Building 4 balconies Top	Illuminance	Fc	0.79	2.6	0.0	N.A.

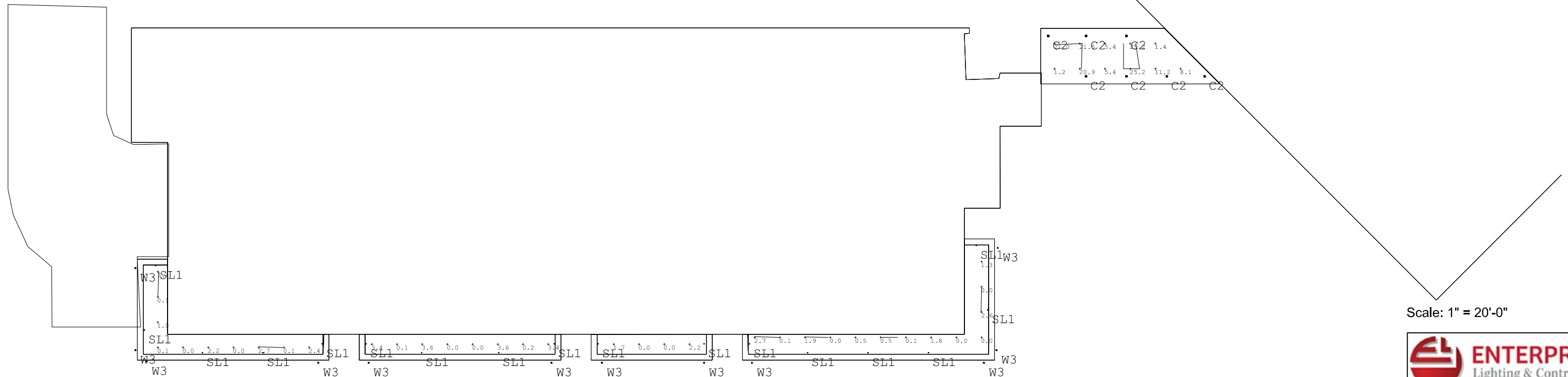

Scale: 1" = 20'-0"

LEVEL 3

BLDG. 1 TO 4

WEST PLACE
Madison, WI

11/21/2016



ENTERPRISE
Lighting & Control

imcmasters@enterpriselighting.com
2007 Pewaukee Road
Waukesha, WI 53188
262-953-2700

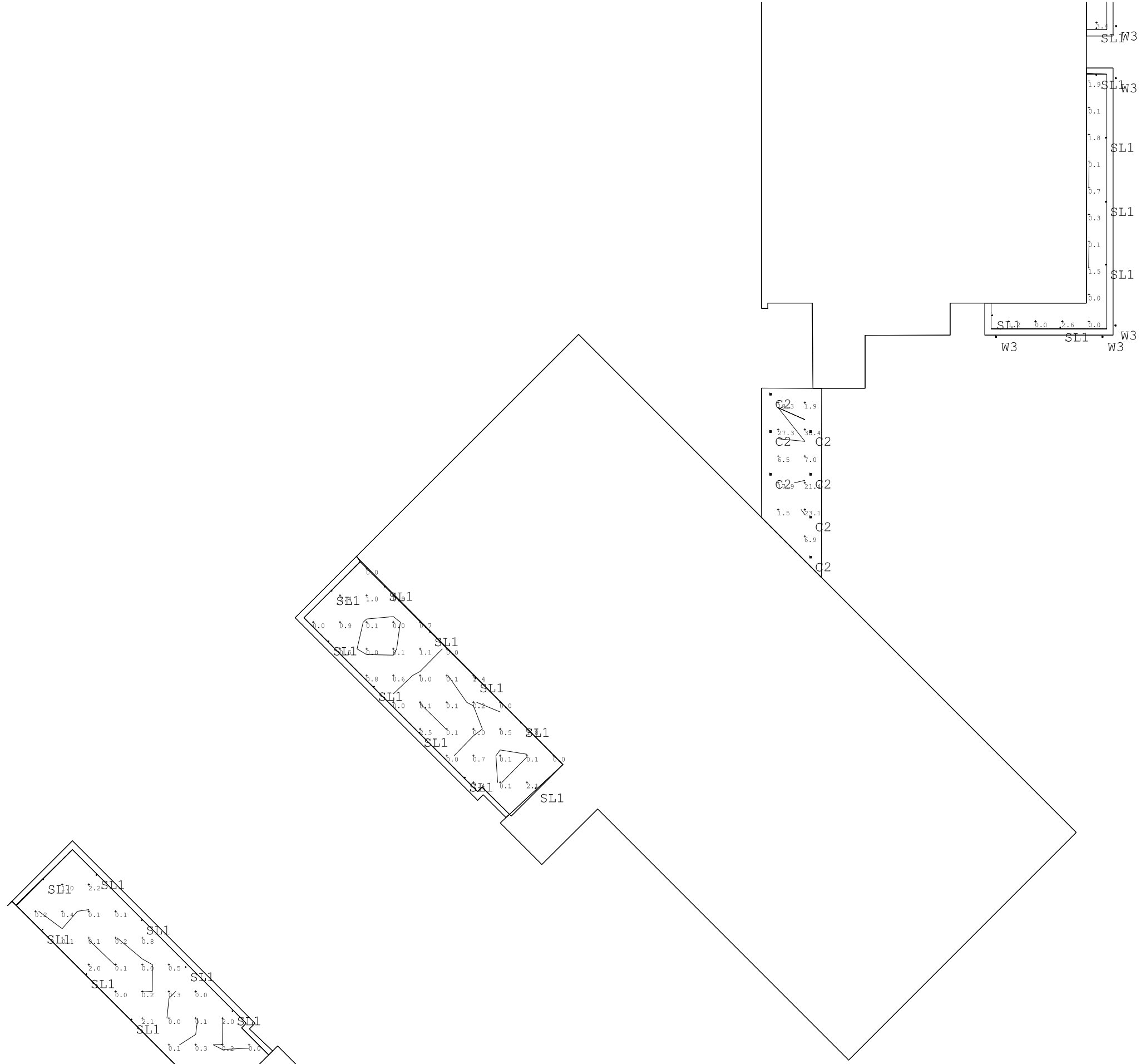

LEVEL 3

BLDGS. 1 TO 4

WEST PLACE
Madison, WI

11/21/2016

Scale: 1" = 20'-0"



ENTERPRISE
Lighting & Control

imcmasters@enterpriselighting.com
2007 Pewaukee Road
Waukesha, WI 53188
262-953-2700

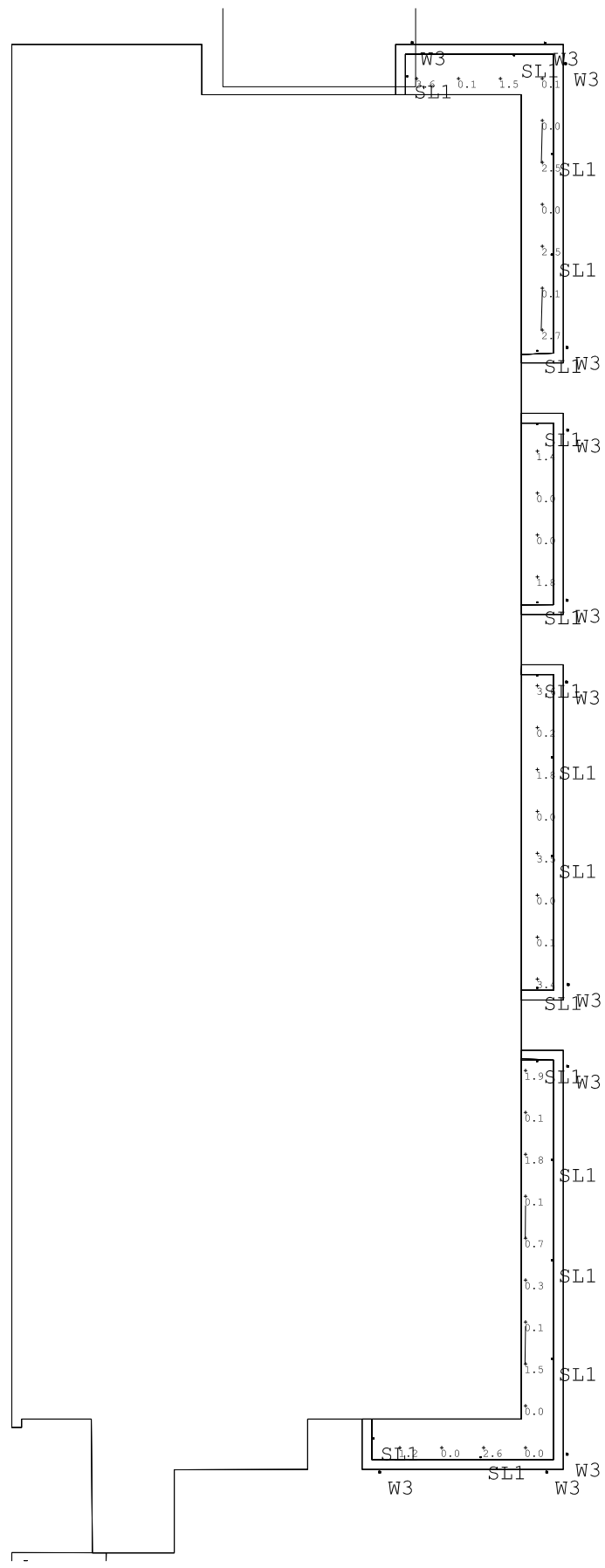

LEVEL 3

BLDGS. 1 TO 4

WEST PLACE
Madison, WI

11/21/2016

Scale: 1" = 20'-0"



ENTERPRISE
Lighting & Control

imcmasters@enterpriselighting.com
2007 Pewaukee Road
Waukesha, WI 53188
262-953-2700

Luminaire Schedule						
Symbol	Qty	Tag	Label	Description	LLF	Lum. Watts
□	23	SL1	SL1 FC SL550-LED	RECESSED WALL STEPLIGHT	0.900	6

Calculation Summary						
Label	CalcType	Units	Avg	Max	Min	Avg/Min
Building 5 Balconies 1 Top	Illuminance	Fc	0.14	0.7	0.0	N.A.
Building 5 Balconies 10 Top	Illuminance	Fc	0.28	0.6	0.0	N.A.
Building 5 Balconies 11 Top	Illuminance	Fc	0.00	0.0	0.0	N.A.
Building 5 Balconies 12 Top	Illuminance	Fc	0.14	0.4	0.0	N.A.
Building 5 Balconies 13 Top	Illuminance	Fc	0.39	2.2	0.0	N.A.
Building 5 Balconies 2 Top	Illuminance	Fc	0.03	0.1	0.0	N.A.
Building 5 Balconies 3 Top	Illuminance	Fc	0.00	0.0	0.0	N.A.
Building 5 Balconies 4 Top	Illuminance	Fc	0.10	0.7	0.0	N.A.
Building 5 Balconies 5 Top	Illuminance	Fc	0.50	3.1	0.0	N.A.
Building 5 Balconies 6 Top	Illuminance	Fc	0.58	1.9	0.0	N.A.
Building 5 Balconies 7 Top	Illuminance	Fc	0.53	1.6	0.0	N.A.
Building 5 Balconies 8 Top	Illuminance	Fc	0.29	1.8	0.0	N.A.
Building 5 Balconies 9 Top	Illuminance	Fc	0.13	0.4	0.0	N.A.
Building 5 Balconies Top	Illuminance	Fc	0.36	1.9	0.0	N.A.

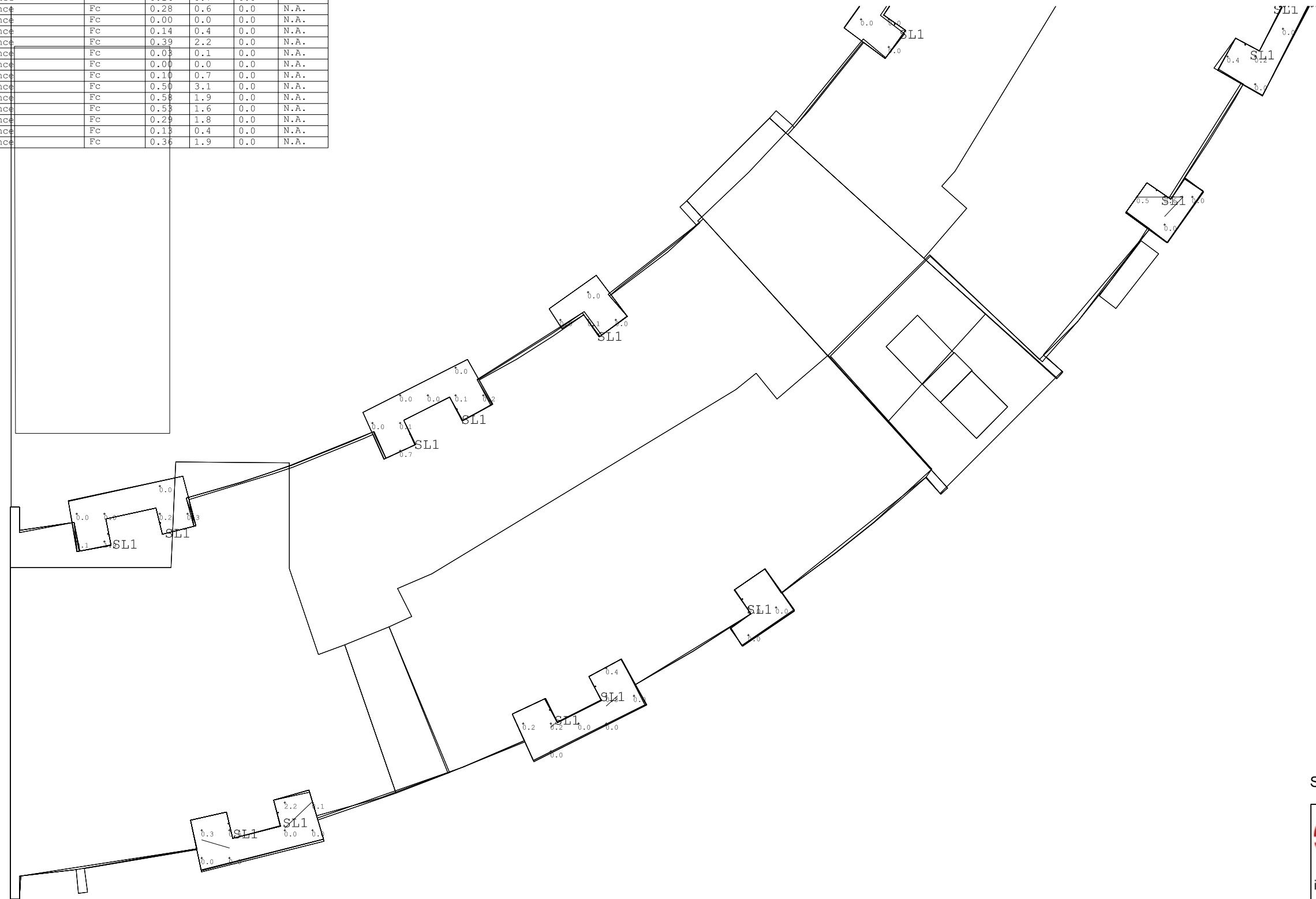

LEVEL 3

BLDG. 5

WEST PLACE
Madison, WI

11/21/2016

Scale: 1" = 20'-0"



ENTERPRISE
Lighting & Control

imcmasters@enterpriselighting.com

2007 Pewaukee Road
Waukesha, WI 53188
262-953-2700

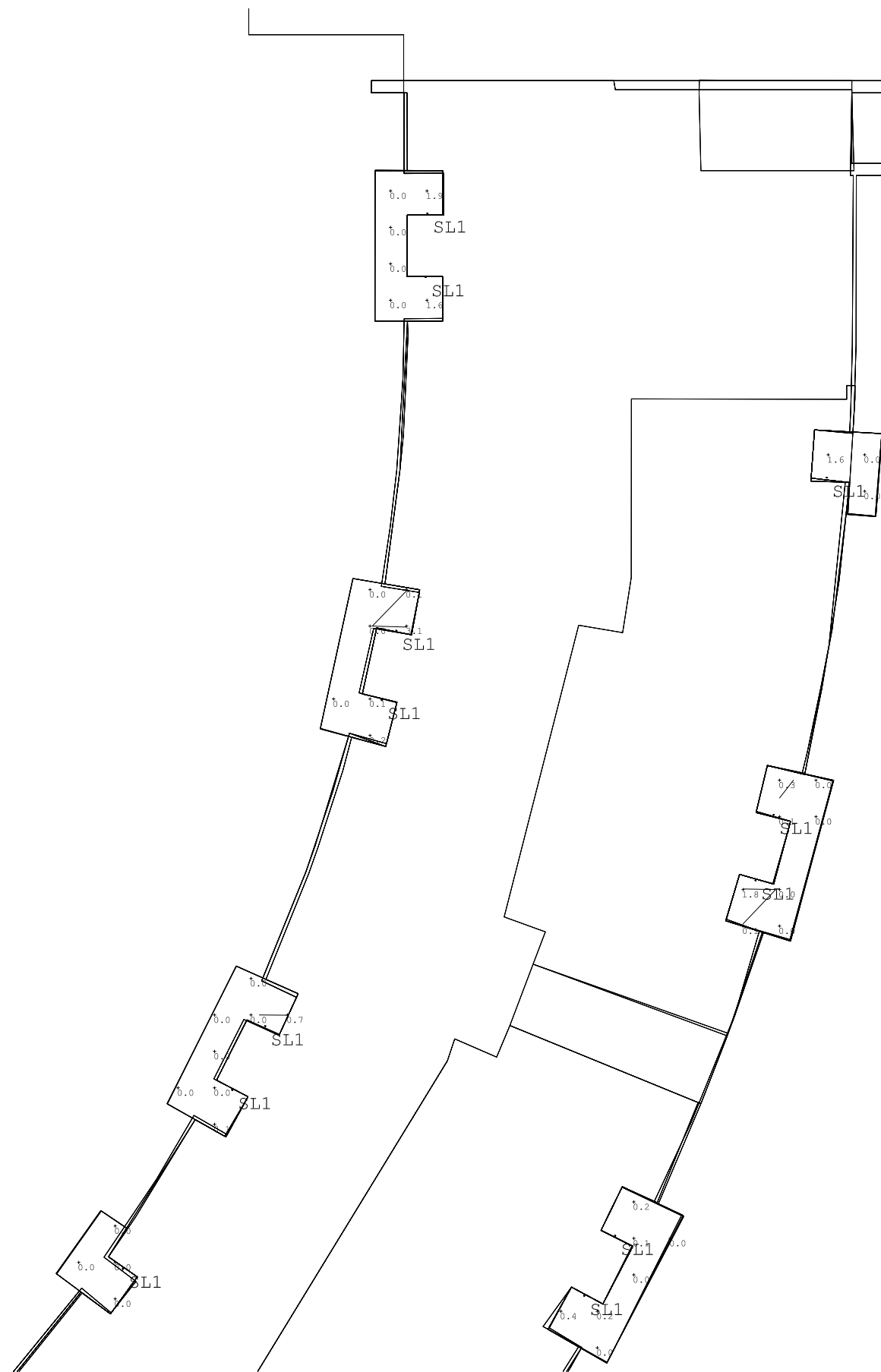

LEVEL 3

BLDG.5

WEST PLACE
Madison, WI

11/21/2016

Scale: 1" = 20'-0"



imcmasters@enterpriselighting.com

2007 Pewaukee Road

Waukesha, WI 53188

262-953-2700

Luminaire Schedule						
Symbol	Qty	Tag	Label	Description	LLF	Lum. Watts
□	23	SL1	SL1 FCSL550-LED	RECESSED WALL STEPLIGHT	0.900	6
○	8	W4	W4 MF Lighting L91-2W30S	L92-2W30S120C0	0.900	1

Calculation Summary						
Label	CalcType	Units	Avg	Max	Min	Avg/Min
Building 5 Balconies 14 Top	Illuminance	Fc	0.13	0.7	0.0	N.A.
Building 5 Balconies 15 Top	Illuminance	Fc	0.09	0.5	0.0	N.A.
Building 5 Balconies 16 Top	Illuminance	Fc	0.05	0.2	0.0	N.A.
Building 5 Balconies 17 Top	Illuminance	Fc	0.13	0.5	0.0	N.A.
Building 5 Balconies 18 Top	Illuminance	Fc	0.08	0.5	0.0	N.A.
Building 5 Balconies 19 Top	Illuminance	Fc	0.47	3.1	0.0	N.A.
Building 5 Balconies 20 Top	Illuminance	Fc	0.50	1.7	0.0	N.A.
Building 5 Balconies 21 Top	Illuminance	Fc	0.47	1.4	0.0	N.A.
Building 5 Balconies 22 Top	Illuminance	Fc	0.20	1.3	0.0	N.A.
Building 5 Balconies 23 Top	Illuminance	Fc	0.09	0.3	0.0	N.A.
Building 5 Balconies 24 Top	Illuminance	Fc	0.00	0.0	0.0	N.A.
Building 5 Balconies 25 Top	Illuminance	Fc	0.23	0.5	0.0	N.A.
Building 5 Balconies 26 Top	Illuminance	Fc	0.00	0.0	0.0	N.A.
Building 5 Balconies 27 Top	Illuminance	Fc	0.09	0.3	0.0	N.A.
Building 5 Balconies 28 Top	Illuminance	Fc	0.28	1.8	0.0	N.A.

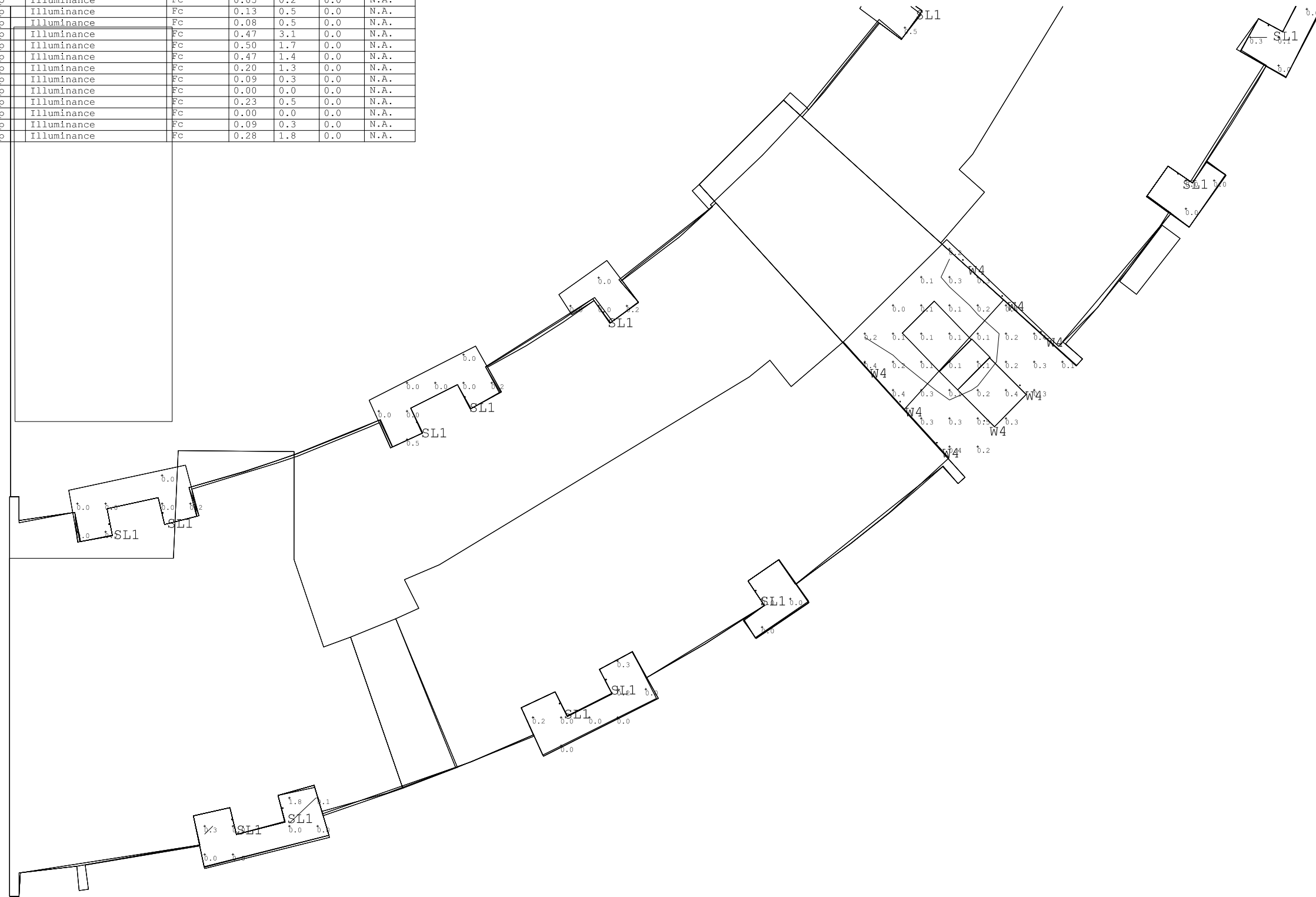

LEVEL 4

BLDG. 5

WEST PLACE
Madison, WI

11/21/2016

Scale: 1" = 20'-0"



ENTERPRISE
Lighting & Control

imcmasters@enterpriselighting.com

2007 Pewaukee Road
Waukesha, WI 53188
262-953-2700

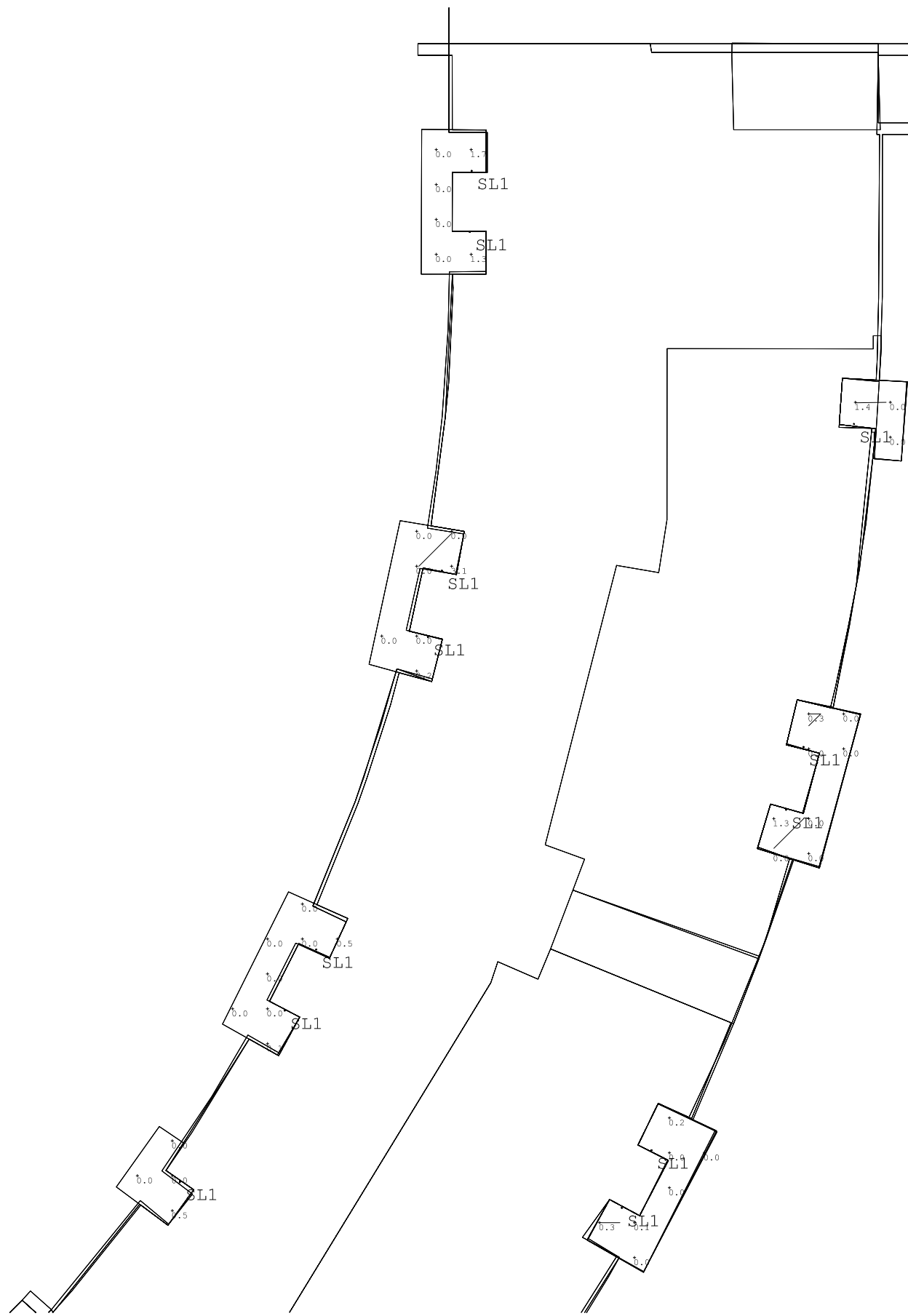

LEVEL 4

BLDG. 5

WEST PLACE
Madison, WI

11/21/2016

Scale: 1" = 20'-0"



imcmasters@enterpriselighting.com

2007 Pewaukee Road

Waukesha, WI 53188

262-953-2700