28J. General Regulations

Introduction

This section includes a variety of requirements that apply to some or all zoning districts, including parking and landscaping standards, height and area exceptions, standards for telecommunications facilities, and environmental and performance standards that apply to all uses and sites.

28J.0801 Accessory Buildings and Structures

(1) In All Districts

- A. Time of construction. No accessory building or structure shall be constructed on any lot prior to the time of construction of the principal building to which it is accessory.
- B. Maximum percentage of rear yard setback. Accessory buildings may occupy a maximum of fifty percent (50%) of the area of the rear yard setback.
- C. Maximum height. The height of the principal building or fifteen (15) feet, whichever is lower. Accessory dwelling units are exempt from this requirement; see Section ___.

(2) In Residential Districts

- A. Maximum area per lot: Total area of accessory buildings measured at ground floor: ten percent (10%) of lot area but no more than one thousand (1,000) square feet. A larger total building area may be allowed by conditional use permit.
- B. Maximum size of accessory building: No individual structure shall exceed five hundred seventy-six (576) square feet in TR districts and eight hundred (800) square feet in other districts at ground level except by conditional use permit. Accessory buildings shall not exceed the size of the principal building.
- C. Placement. Accessory buildings may be located in the following locations:
 - 1. In a rear yard a minimum of three (3) feet from any property line;
 - 2. In a side yard if located behind the rear plane of the principal building, a minimum of three (3) feet from any property line;
 - 3. In the side or rear yard of a corner lot, a minimum distance from the street side lot line equal to the setback required for a principal building in the district;
 - 4. In the rear yard of a reversed corner lot, no closer to the street side lot line than the front yard setback of the adjacent property, for the first twenty-five (25) feet from the common property line. Beyond this distance, the minimum setback shall be equal to the setback required for a principal building in the district.
- D. Shared garages. A detached garage may be constructed across a lot

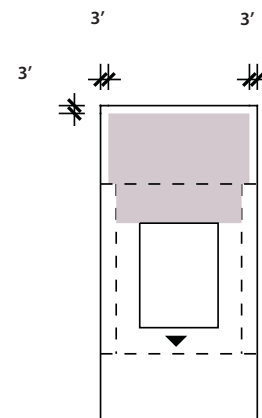

Accessory building on interior lot may be placed within shaded area

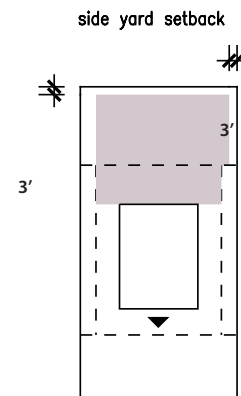

Accessory building on corner lot may be placed within shaded area

line by abutting property owners, anywhere a garage is permitted within three (3) feet of the lot line, if: 1) there is a joint driveway leading to it; and 2) the property owners have a joint access and maintenance agreement approved and recorded by the Director, relating to the shared garage.

- E. Side and rear yard garage replacement. A detached garage located in a side or rear yard may be replaced within the existing setbacks, if: the replacement is within one year of demolition; the Zoning Department has verified the location and size of the existing or demolished garage; the enlarged structure does not exceed twenty-four (24) feet in length or width; and neither the width or length is increased by more than two (2) feet.
- F. Garages in embankments in front yards. Where the mean natural grade of a front yard is more than eight (8) feet above curb level, a private garage may be erected within the front yard setback, provided that:
 1. The garage must be located at least five (5) feet from the front lot line; and
 2. At least one-half (½) of the height of the garage shall be below the mean grade of the front yard.

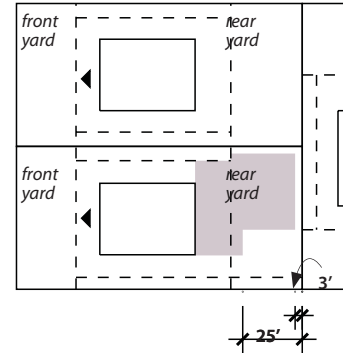

Accessory building on reversed corner lot may be placed within shaded area

(3) Nonresidential Districts

Accessory buildings shall be located a minimum of ten (10) feet from the rear lot line.

28J.0802 Encroachments into Setback Areas [was "required yards"]

(1) Permitted Setback Encroachments

The following structures or features are permitted in setback areas. The letter "A" in the table indicates that the structure or feature is allowed anywhere in the setback. A number indicates the maximum distance in feet that the structure or feature is allowed to extend into the setback. No subterranean encroachments are allowed except as noted in Table __.

Structure or Feature	All Yards	Front Yard Setback	Side Yard Setback	Rear Yard Setback
Accessibility accommodations as specified in Section __	A			
Accessory sheds, toolrooms, doghouses, and similar buildings or structures (see Sec. xxx, Accessory Buildings)			A	A
Air conditioning condensing unit			A	A
Arbors and trellises	A			
Awnings	A			
Basement storm doors providing access to below-grade stairs				A
Balconies				6
Bay windows, max. one story in height, see Section __		3	2	3
Chimneys, flues	2			

Structure or Feature	All Yards	Front Yard Setback	Side Yard Setback	Rear Yard Setback
Compost bins ^a			3 from prop. line or building	3 from prop. line or building
Eaves and gutters		3	2	3
Egress windows	minimum egress req.			
Decks, uncovered, elevated over 3' above adjacent ground level				6
Decks, uncovered, elevated not more than 3' above adjacent ground level				A
Fences, walls, hedges; see Section ___	A			
Fire escapes			1/3 width of yard; up to 3 ft.	6
Flagpoles or garden ornaments	A			
Garages, detached, (see Sec. xxx, Accessory Buildings)			A	A
Laundry drying equipment	A			
Licensed radio towers <75' and receiving devices				A
Open porches		6		
Open off-street parking spaces, see Section []	A			
Recreational equipment, minor	A			
Recreational equipment, major				A
Solar energy systems or devices	A			
Steps and platforms, uncovered, needed for building access. ^b		Note (b)		
Steps, below-grade, needed for access to basement entrances	A			
Swimming pools, hot tubs, whirlpools, or similar structures				3 ft. from prop. line
Wind energy systems or devices	A			

(a) See Madison General Ordinances 7 for compost bin standards.

(b) Uncovered entrance platforms necessary to comply with current ingress and egress regulations may extend four (4) feet into the front yard setback area and shall be no wider than six (6) ft. and steps from the platform may extend into the setback area for the distance needed to meet minimum building code requirements for risers and treads. Replacement steps for porches may be as wide as the steps being replaced and may extend into the setback area for the distance needed to meet minimum building code requirements for risers and treads.

28J.0803 Environmental Protection Standards

(1) General Standards

A. All uses shall be conducted so as to prevent or substantially minimize any nuisance, hazard, or commonly recognized offensive conditions,

including creation or emission of dust, gas, smoke, noise, fumes, odors, vibrations, particulate matter, chemical compounds, electrical disturbance, humidity, heat, cold, glare, or night illumination.

- B. No use shall result in the harmful discharge of any waste materials across the boundaries of the subject property or into the ground, into any sanitary or storm sewer system, into any water body or water system, or into the atmosphere.
- C. The Zoning Administrator may require evidence of adequate controls on any potential nuisances or hazards prior to issuing a zoning or occupancy certificate.

(2) Activities Which May Be Potential Hazards Or Nuisances

- A. Productive Processes. All activities involving the production, processing, cleaning, servicing, testing or repair of materials, goods or products shall be conducted in such a manner whereby there shall be no danger of fire or explosion, no offensive noise, vibration, smoke, dust, odor, glare or heat, and no objectionable influence detrimental to the public health, safety, comfort or general welfare of the immediate neighborhood or community.
- B. Explosives. Laboratory scale quantities of division 1.1 to 1.3 explosives and forbidden explosives as defined by the United States Department of Transportation in 49 CFR §173.50 and §173.54, respectively, as amended from time to time, are allowed outside the IG zoning district when stored according to National Fire Protection Association [NFPA] standards and provided that the total amount of all said explosives are two (2) pounds or less per building. Laboratory scale quantities of explosive chemicals must be stored in containers, in quantities no greater than their original shipment quantities.
- C. Fissionable non-fissile material. Notwithstanding the restrictions contained in §28.10(1)(a), fissionable non-fissile material is allowed in other zoning districts when the use of such material is accessory to a principal use allowed within the zoning district and when licensed or registered, as may be required by state or federal law.
- D. Fissile material. The storage, utilization or manufacture of more than one gram of fissile material is permitted only in the IG district and only when not less than three hundred (300) feet of a boundary of any other zoning district. However, utilization of fissile material outside the IG district is allowed when the use of such material is in nuclear gauges or calibration instruments, for medical purposes or fission chambers operated by a college or university for instructional purposes and only when said uses are licensed or registered, as may be required by state or federal law.

(3) Drainage Courses.

- A. Statement Of Purpose. This subsection is established to promote the public health, safety and general welfare of the community by regulating and restricting the development of areas along or in

drainageways, channels, streams and creeks. The regulations which follow are intended to protect and to preserve the location, character and extent of such drainageways, channels, streams and creeks, and to protect persons and property from the hazards of development in areas which may be subject to inundation.

B. General Regulations.

1. No building or structure shall be erected within a drainage course. For the purpose of this and the following paragraphs, a drainage course shall include any area such as drainageways, channels, streams and creeks, designated as such on the zoning map and any area designed or intended for use for drainage purposes as shown in a recorded subdivision.
2. No filling of land shall be permitted within a drainage course, or on any lands within two hundred (200) feet, or more than two hundred (200) feet when so designated on the zoning map, of the center line of such drainage course, except upon issuance of a certificate by the City Engineer that such filling will not obstruct the flow of water or otherwise reduce the water carrying capacity of such drainage course, or impair the design and character of such drainage course.
3. No excavating of land shall be permitted within a drainage course, or on any lands within two hundred (200) feet, or more than two hundred (200) feet when so designated on the zoning map, of the center line of such drainage course, except upon issuance of a certificate by the City Engineer that such excavating will not divert water from the established channel, will not cause flooding of lands outside such drainage course, will not cause any erosion, and will not otherwise impair the design and character of such drainage course.
4. No relocation, enclosure or bridging of a drainage course shall be permitted except upon issuance of a certificate by the City Engineer that the location, character and extent of such relocation, enclosure or bridging of the drainage course shall be in the public interest.
5. The City Engineer may require the submittal of any such information which he or she considers essential for the proper enforcement of the above regulations.

28J.0804 Exceptions to Height and Bulk Limits

(1) Height Measurements

In the case of alterations, additions, or replacement of existing buildings, height shall be measured from the natural grade prior to redevelopment. Natural grade shall be determined by reference to a survey or other information as determined by the Zoning Administrator.

(2) Height Limit Exceptions

The following structures are permitted to exceed the maximum height regulations within any district where the use is allowed: church spires, belfries,

cupolas and domes, water towers, flagpoles, chimneys, communication towers and elevator penthouses. Communication towers within residential districts shall not exceed a maximum height of seventy-five (75) feet above grade. All structures shall comply with the provisions of subsection (3) below.

(3) Capitol View Preservation

No portion of any building or structure located within one mile of the center of the State Capitol Building shall exceed the elevation of the base of the columns of said Capitol Building or one hundred eighty-seven and two-tenths (187.2) feet, City datum. Provided, however, this prohibition shall not apply to any church spires, flagpoles, communication towers (except communication towers in residential districts, which shall comply with the requirements of Section (1) above), elevator penthouses, screened air conditioning equipment on existing buildings and chimneys exceeding such elevation, when approved as conditional uses. For the purpose of this subsection, City datum zero (0.00) feet shall be established as eight hundred forty-five and six-tenths (845.6) feet above sea level as established by the United States Coast and Geodetic Survey.

Capitol view height limits will likely be integrated into the Downtown districts as well as appearing here.

(4) Public Utility Exemptions

- A. The following public utility uses, which are essential in most districts, shall be permitted in any zoning district: poles, towers, wires, cables, conduits, vaults, pipelines, laterals or any other similar distributing equipment for a public utility. However, where such public utility uses are proposed to be located across unplatted lands, such uses may be allowed subject to the issuance of conditional use permits in accordance with the provisions of Section [28.12(11)].
- B. The regulations in this ordinance governing lot size, bulk requirements, and access to improved public streets shall not apply to any lot designed or intended for a public utility and public service use when approved by the Plan Commission.

28J.0805 Lot Division, Creation and Access

(1) Division of Improved Zoning Lots

Lot division shall be governed by the provisions of MGO 16 and the following regulations:

- A. An improved zoning lot shall not be reduced in size or divided into two (2) or more separate lots unless each lot that results from such reduction or division meets all requirements of the zoning district in which it is located.
- B. Lot divisions shall comply with the minimum lot size requirements of each zoning district, except that non-buildable lots such as outlots are exempt from minimum lot requirements.

(2) Access to Public Street.

Every zoning lot shall front on or an improved public street, with a minimum of thirty (30) feet of street frontage, with the exception of lots in approved

planned commercial sites or planned development districts.

(3) Development Of Deep Residential Lots

- A. **Statement Of Purpose.** This subsection is established to allow the intensive development of certain deep residential lots which could not otherwise be fully developed under this or any other development control ordinance. The intensive development of a deep lot is not a matter of right but instead a privilege granted to the developer by the City when the Plan Commission makes a finding that such development is in the public interest.
- B. **General Regulations.** The Plan Commission may allow, after a public hearing and notice as set forth in Section [conditional use] 28.12(11)(e)&(f) and consideration of the standards set forth in Section 28.12(11)(g), the development of a deep residential zoning lot into not more than four (4) zoning lots, provided that the following criteria are met:
1. The front lot(s) shall have a lot width not less than that required in the district in which it is located;
 2. The rear lot shall have frontage onto an improved public street for a width not less than thirty (30) feet;
 3. The strip of land of land between the improved public street and the remainder of the rear lot shall not contain any buildings or structures and said strip of land shall not be used to satisfy any area, yard or usable open space requirement for the rear lot;
 4. All of the lots proposed provide the minimum required lot area;
 5. The house numbers for all lots shall be on a sign visible from the public street.
- C. A building permit for residential construction shall be issued for any zoning lot legally created, pursuant to this section, prior to the effective date of this ordinance.

28J.0806 Use of Trailers and Containers

Trailers and containers used for over-the-road hauling shall not be used for or converted for office, commercial, residential or storage in any district.

28J.0807 Zoning Lots and Planned Commercial Sites

(1) Residential Zoning Lots

Except in the case of multifamily complexes, not more than one (1) principal detached residential building shall be located on a zoning lot, nor shall a principal detached residential building be located on the same zoning lot with any other nonresidential principal building or use.

(2) Planned Commercial Sites

The purpose of this subsection is to allow efficient and economical design and greater coordination and flexibility in the development of nonresidential and mixed use properties, while ensuring substantial compliance with the basic intent of the Zoning Code and Subdivision Regulations.

- A. A planned commercial site, as defined, shall have a plan and reciprocal land use agreement approved by the Traffic Engineer, City Engineer and Director of Planning and Community and Economic Development recorded in the office of the Dane County Register of Deeds.
- B. An existing planned commercial site may not be changed without approval by the Traffic Engineer, City Engineer and Director of Planning and Community and Economic Development, or approval of the Plan Commission.
- C. Every planned commercial site shall front on a public street.
- D. A planned commercial site containing more than forty thousand (40,000) square feet of gross floor area and where twenty-five thousand (25,000) square feet of gross floor area is designed or intended for retail use or for hotel or motel use, shall be subject to the procedure for approving a conditional use in Sec. 28.12(11) and subject to review by the Urban Design Commission under the provisions of Sec. 33.25(4)(f).
- E. All new retail establishments with a total gross floor area (GFA) of forty thousand (40,000) square feet or more that are part of a planned commercial site are subject to review by the Urban Design Commission under the provisions of Sec. 33.25(4)(f).
- F. Where multiple commercial uses shall be located in a planned commercial site, a plan for building placement, shared parking and access and any easement documents necessary to facilitate those plans. The plan for building placement shall be submitted showing the following:
 1. The arrangement of buildings, parking facilities, internal circulation of pedestrians and vehicles, access to individual development sites from public streets and internal drives, and the location of storm drainage facilities, open spaces and any ground-mounted signage.
 2. Identification of uses within the commercial center and the gross square footage of building sites, either for the overall development or for the individual sites within the planned commercial site.
 3. The general arrangement of individual lots, outlots, tracts, easements, and all dedications to the public resulting from the planned commercial development. The planned commercial site plan may be used as a preliminary subdivision plat if it includes all of the information required for a preliminary plat under Sec. 16.23 (7)(a).

28J.0808 Lakefront Development

The following regulation shall apply to all zoning lots that abut Lake Monona, Lake Mendota, Lake Wingra, Monona Bay, and associated harbors. New development on lakefront lots is a conditional use. For purposes of this section, new development shall be a new principal building, an addition or additions to an existing principal building totaling in excess of five hundred (500) square feet of floor area during any ten (10) year period, or any accessory building. Additions to principal buildings of less than five hundred (500) square feet of floor area during any ten (10) year period shall meet the requirements of this section but may be permitted rather than conditional.

(1) General Regulations

- A. Upon the filing of an application for a conditional use permit, the development plan shall show a complete inventory of shoreline vegetation in any area proposed for building, filling, grading or excavating. In addition, the development plan shall indicate those trees and shrubbery which will be removed as a result of the proposed development. The cutting of trees and shrubbery shall be limited in the strip thirty-five (35) feet inland from the normal waterline. On any zoning lot not more than thirty percent (30%) of the frontage shall be cleared of trees and shrubbery. Within the waterfront setback requirements tree and shrub cutting shall be limited by consideration of the effect on water quality, protection and scenic beauty, erosion control and reduction of the effluents and nutrients from the shoreland.
- B. Any building development for habitation shall be served with public sanitary sewer.
- C. Filling, grading and excavation of the zoning lot may be permitted only where protection against erosion, sedimentation and impairment of fish and aquatic life has been assured.
- D. Where the City's adopted Master Plan includes a pedestrian walkway or bike path along the shoreline, the proposed development shall not interfere with its proposed location.
- E. Construction of marine retaining walls or bulkhead may be permitted providing such construction does not protrude beyond the established shoreline of the adjacent properties. Said retaining walls and bulkheads will be permitted only for the purpose of preventing shoreline recession. The filling and grading of the shoreline shall occur only in the construction of such retaining walls or bulkheads.
- F. In addition to complying with the above standards, boathouses shall not be constructed for human habitation.

(2) Residentially-Zoned Lakefront Properties

- A. Lakefront Yard Setback. The yard that abuts the lake, typically the rear yard, shall be referred to as the "lakefront yard." The yard opposite the lakefront yard shall be treated as the front yard. The

minimum depth of the lakefront yard from the Ordinary High Water Mark shall be calculated using one of the two following methods, provided that in no case shall buildings be located closer to the OHWM than twenty-five (25) feet.

1. The average setback of the principal building on the two adjoining lots, provided that the setbacks of those buildings are within ten (10) feet of one another; or
 2. Based on the median setback of the principal building on the five (5) developed lots or three hundred (300) feet on either side (whichever is less), or thirty percent (30%) of lot depth, whichever number is greater (see illustration).
- B. Building Bulk Limitation. The residential floor area ratio of the principal building on the lot shall not exceed one hundred twenty-five percent (125%) of the median floor area ratio of all residentially-zoned buildings within one thousand (1,000) feet on either side. Residential floor area as defined includes finished or occupiable attic and basement space, attached garages and enclosed porches. Floor area information shall be obtained from the City of Madison assessment records.
- C. Building Height Limitation. The maximum height of the principal building on the lot shall not exceed one hundred twenty-five percent (125%) of the median height of all residentially-zoned principal buildings within one thousand (1,000) feet on either side. Building height is measured from natural grade.

Sample Calculation of Minimum Lakefront Yard Setback

Existing Lakefront Yard Setbacks within 5 lots or 300 feet:

- A: 35'
- B: 45'
- C: 35'
- D: 75'
- E: 45'
- F: 30'
- G: 35'
- H: 45'
- I: 60'

Lakefront Yard Setback calculation:

Median of A to I: 45'

or

30% of lot depth (180'): 54'

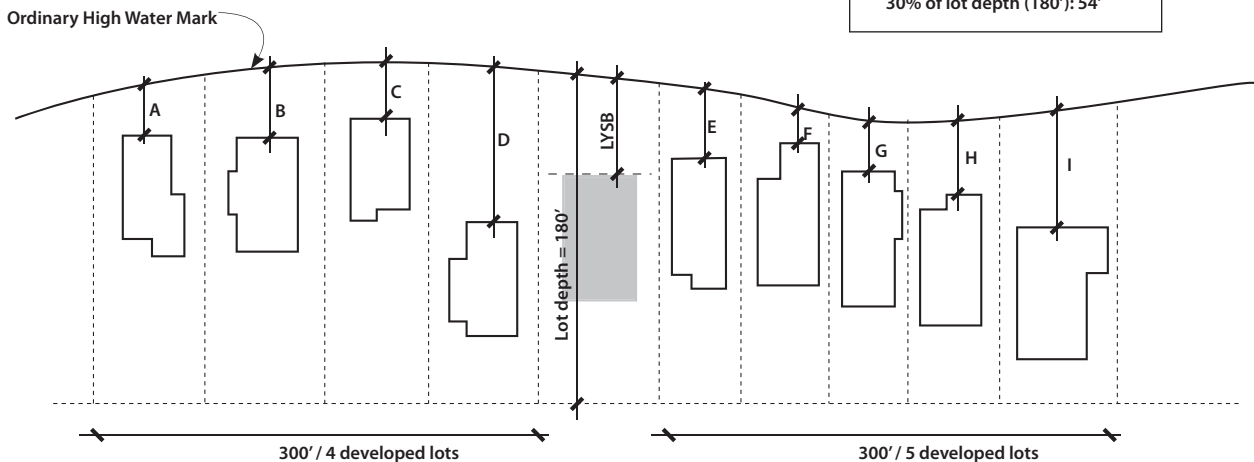

28J.0809 Development Adjacent to Public Parks

Nonresidential development within two hundred (200) feet of the boundary of a City-owned public park shall be reviewed as a conditional use. The purpose of this requirement is to assess the impact of proposed development on natural resources, drainage patterns, pedestrian traffic and recreational uses of the park. Conditional use applications shall include the following:

- A. A complete inventory of vegetation in any area proposed for development within one hundred (100) feet of the park boundary.
- B. Any proposed cutting of trees or removal of vegetation within one hundred (100) feet of the park boundary. Removal of vegetation may be limited within thirty-five (35) feet of the park boundary.
- C. Grading and drainage within thirty-five (35) feet of the park shall be reviewed for its effect on drainage patterns and vegetation within the park.

28J.0810 Usable Open Space

Usable open space shall be provided on each lot used in whole or in part for residential purposes, except where specifically exempted.

- A. Usable open space at ground level shall be in a compact area of not less than two hundred (200) square feet, with no dimension less than eight (8) feet and no slope grade greater than ten percent (10%).
 1. Where lot width is less than forty (40) feet, the minimum dimension of usable open space may be reduced to six (6) feet.
- B. Usable open space shall not include areas occupied by buildings, driveways, drive aisles, off-street parking, paving and sidewalks, except that paved paths no wider than five (5) feet, and pervious pavement designed for outdoor recreation only may be included in usable open space.
- C. Within the Central Area, as defined, where usable open space requirements cannot be met due to limited existing lot area, or building/parking placement, required landscaped areas may be used to meet the usable open space requirement, provided that said landscaped areas are a minimum of five (5) feet in width.
- D. Within the TR-U1 and TR-U2 Districts and within all Mixed-Use and Employment Districts (PLUS DOWNTOWN DISTRICTS TBD), roof decks and balconies may be used to meet up to seventy five percent (75%) of the minimum open space requirements, provided that they meet the following standards:
 1. Balconies shall have a minimum dimension of four and one-half (4½) feet.
 2. Roof decks shall have a minimum dimension of fifteen (15) feet and shall be free of any obstructions, improved and

available for safe and convenient access to all occupants of the building.

- E. The provisions of this section may be modified for conditional uses subject to Plan Commission review.

28J.0811 Parking and Loading Standards

(1) Statement of Purpose

This section establishes minimum and maximum parking space ratios, and standards for the layout and design of parking spaces, lots and structures. It also includes shared parking incentives, and reduction of off-street parking in favor of transit or other travel modes. The standards in this section are intended to:

- A. Encourage reduction of surface parking as a means of reducing dependence on private automobiles and reducing the pollution and congestion that are associated with automobile use.
- B. Encourage reduction of surface parking as a means of fostering more compact development patterns and encouraging transit, bicycle and pedestrian circulation.
- C. Minimize the adverse effects of off-street parking and loading on adjacent properties.
- D. Minimize spillover on-street parking in neighborhoods.
- E. Encourage shared parking arrangements that will support mixed use development and compact development patterns.
- F. Encourage bicycle circulation by providing adequate parking and storage space for bicycles.
- G. Encourage parking locations that do not disrupt Madison's traditional streetscape.

(2) Number of Parking Spaces Required

Table 28J-1 establishes the minimum number of parking spaces required, the maximum number of parking spaces permitted, and the minimum number of bicycle spaces required, for the uses indicated.

- A. No minimum parking. In the Central area, as defined, and the following districts, there is no specified minimum requirement for off-street parking of automobiles, except as specified under Subsection B. Maximum parking requirements continue to apply. Off-street parking for bicycles is required.
 - 1. Neighborhood Mixed Use (NMU) District
 - 2. Traditional Shopping Street (TSS) District
 - 3. Mixed Use Center (MXC) District
 - 4. Commercial Center (CC) District

5. Traditional Workplace (TW) District
 6. Employment Campus (EC) District
 7. Suburban Employment Center (SEC) District
 8. Industrial - Limited (IL) District
 9. Industrial - General (IG) District
- B. Minimum parking exceptions. Minimum parking requirements shall apply in the above districts for any building, use, or addition that falls into the following categories:
1. Buildings or uses that exceed the following gross floor area:
 - a. Neighborhood Mixed Use (NMX) District: Buildings, uses, or additions exceeding ten thousand (10,000) square feet gross floor area
 - b. Traditional Shopping Street (TSS) District: Buildings, uses, or additions exceeding ten thousand (10,000) square feet gross floor area for an individual establishment or twenty-five thousand (25,000) square feet gross floor area for a mixed-use or multi-tenant building.
 - c. Traditional Workplace (TW) District: Buildings, uses, or additions exceeding twenty-five thousand (25,000) square feet gross floor area.
 2. Within the NMX, TSS and TW districts, food and beverage uses shall meet minimum parking requirements if other food and beverage uses that do not meet minimum parking requirements exist within three hundred (300) feet of the proposed use. This requirement may be waived parking is provided on a shared district-wide basis.
 3. For conditional uses, parking requirements may be established as part of the conditions pertaining to a use.
- C. Parking waiver. For nonresidential uses, the first five (5) spaces required under “Minimum Parking” or the first ten percent (10%) of parking required, whichever is greater, may be waived.
- D. Where number of employees is used to determine parking, it shall be based on the number of employees on the maximum working shift at the time the occupancy permit is requested. Parking requirements based on number of employees will not change unless new construction or expansion is proposed.
- E. Floor area calculation. Floor area used to calculate parking and loading requirements is defined as the sum of the gross horizontal areas of the floors or parts of a building devoted to the use, measured from the exterior faces of the exterior walls or from the center line of walls separating two buildings. It does not include porches, garages, or space in a basement or cellar when used for storage or incidental uses.

- F. Bicycle space minimum. A minimum number of two (2) bicycle spaces (the equivalent of one two-sided bike rack) is required for nonresidential uses.
- G. Computation. Fractional space requirements of up to one-half ($\frac{1}{2}$) space shall be rounded down to the next whole number and greater than one-half ($\frac{1}{2}$) rounded up to the next whole number.
- H. Parking requirements for persons with disabilities. The provisions contained in Sec. 101.12, 346.503, and Sec. 346.56 Wis. Stat. and any related Wisconsin Administrative Code sections are hereby adopted by reference and made applicable to all parking facilities whenever constructed.
- I. Unspecified uses. Where buildings are constructed without uses specified, the use with the highest parking requirement among all uses specified for the zoning district where the site is located shall be used to calculate off-street parking requirements.
- J. Unlisted uses. The zoning administrator shall establish the minimum and maximum parking and minimum loading required for any use not listed in Table __. The zoning administrator may consider, but shall not be limited to, the following in establishing parking requirements for an unlisted use:
1. Documentation. Documentation regarding the actual parking and loading demand for the proposed use.
 2. Evidence. Evidence in available planning and technical studies relating to the proposed use.
 3. Other jurisdictions. Required parking and loading for the proposed use as determined by other comparable jurisdictions.
 4. Estimation of similar uses. Examination of the parking and loading requirements for uses most similar to the proposed use.

Table 28J-1: Off-Street Parking Requirements

Use	Minimum	Maximum	Bicycle
Residential - Family Living			
Single-family detached dwellings	0	4 outside spaces	-
Two-family dwelling – two-flat	0	4 outside /d.u.	-
Two-family dwelling - twin	0	4 outside /d.u.	-
Three-family dwelling	2	2 per dwelling	-
Single-family attached dwelling	1 per dwelling	2 per dwelling	1 per dwelling
Multi-family dwelling	1 per dwelling	2.5 per dwelling	1 per unit up to 2-bedrooms, $\frac{1}{2}$ space per add'l bedroom; 1 guest space per 10 units
Accessory dwelling	0	2 per dwelling	1 per dwelling
Manufactured home, mobile home	0	(see lot coverage)	1 per dwelling
Caretaker's dwelling	0	2 per dwelling	1 per dwelling

Use	Minimum	Maximum	Bicycle
Residential - Group Living			
Adult family home	1	4	1 per dwelling
Community living arrangement	as determined by zoning administrator based on number of rooms/ employees	150% minimum	1 per dwelling plus 1 per 3 rooms
Cohousing community	as determined by zoning administrator	150% minimum	1 per dwelling
Co-operative housing	0 if single-family; same as multi-family for that dwelling type	1 per bedroom	1 per bedroom plus 1 guest space per 4 bedrooms units
Lodging house, rooming house	as determined by zoning administrator based on number of rooms/ employees	1 per bedroom	1 per bedroom plus 1 guest space per 4 units
Dormitory, fraternity or sorority	1 per 4 lodging rooms; or as established in campus master plan	1 per bedroom	1 per bedroom plus 1 guest space per 4 units
Retirement home, assisted living, congregate care	1 space per 10 dwelling units or lodging rooms; 1 per 5 beds	1 per dwelling unit	1 per 4 units + 1 per 5 employees
Religious community	see place of worship	1 per bedroom	1 per bedroom
Civic and Institutional Uses			
Cemetery, mausoleum	as determined by zoning administrator	as determined by zoning administrator	as determined by zoning administrator
Day care, adult, child, nursery school	1 per 15 clients	200% of minimum	1 per 5 employees
Library, museum	0	1 per 400 square feet floor area	1 per 2,000 square feet floor area
Mission house in conjunction with religious institution	see place of worship	1 per 400 square feet floor area	1 per 400 square feet floor area
Parks and playgrounds	none, except where required for specific facilities, as determined by zoning administrator		
Place of worship	1 per 10 seats or 15 lineal feet of seating area in the main worship space. If no fixed seats, 1 per 70 sq. ft. of floor area in main worship space	150% of minimum	1 per 50 seats or 75 lineal feet of seating area or 1 per 350 feet of floor area in main worship space
Public safety facilities (fire, police stations, etc.)	as determined by zoning administrator	as determined by zoning administrator	as determined by zoning administrator
Schools, public and private	1 space per classroom + 1 space per 5 students of legal driving age based on the maximum number of students attending classes at any one time	1 space per classroom + 1 space per 3 students of legal driving age based on the maximum number of students attending classes at any one time	1 space per 5 students

Use	Minimum	Maximum	Bicycle
Schools, arts, technical or trade	1 per classroom + 1 per 5 students of legal driving age based on the maximum number of students attending classes at any one time	1 per classroom + 1 per 3 students of legal driving age based on the maximum number of students attending classes at any one time	1 space per 5 students
Universities, colleges	1 per classroom and 1 per 5 students based on the maximum number of students attending classes at any one time; or as established in campus master plan	1 per classroom and + 1 per 3 students based on the maximum number of students attending classes at any one time; or as established in campus master plan	1 per classroom and <u>1 per 5 students</u> , or as established in campus master plan
Mixed Commercial-Residential Uses			
Live/work unit	0 (d.u.) +1 per 2 employees	2 total	1 per dwelling
Mixed commercial/residential use	calculated based on separate components (see shared parking standards)	calculated based on separate components (see shared parking standards)	calculated based on separate components (see shared parking standards)
Commercial Uses			
Offices	1 per 400 sq. ft. floor area	1 per 200 sq. ft. floor area	1 per 2,000 sq. ft. floor area
Office, call center	1 per 2 employees	1 per employee	1 per 10 employees
Artist, photographer studio, etc.	1 per 400 sq. ft. floor area	1 per 200 sq. ft. floor area	1 per 2,000 sq. ft. floor area
Insurance office, real estate office, sales office	1 per 400 sq. ft. floor area	1 per 200 sq. ft. floor area	1 per 2,000 sq. ft. floor area
Medical Facilities			
Clinic, medical, dental or optical	1 per 300 sq. ft. floor area	1 per 150 sq. ft. floor area	1 per 2,000 sq. ft. floor area
Hospital	1 per 4 beds or based on a parking study or campus master plan	as determined by zoning administrator	1 per 2,000 sq. ft. floor area
Medical laboratory	1 per 400 sq. ft. floor area	1 per 200 sq. ft. floor area	1 per 2,000 sq. ft. floor area
Physical, occupational or massage therapy	1 per 400 sq. ft. floor area	1 per 200 sq. ft. floor area	1 per 2,000 sq. ft. floor area
Veterinary clinic, animal hospital	1 per 400 sq. ft. floor area	1 per 200 sq. ft. floor area	1 per 2,000 sq. ft. floor area
Retail Sales and Services			
General retail	1 per 400 sq. ft. floor area	1 per 200 sq. ft. floor area	1 per 2,000 sq. ft. floor area
Animal boarding facility, kennel	1 per 400 sq. ft. floor area	1 per 200 sq. ft. floor area	1 per 2,000 sq. ft. floor area
Bank, financial institution	1 per 400 sq. ft. floor area	1 per 200 sq. ft. floor area	1 per 2,000 sq. ft. floor area
Building materials and home improvement retail center	1 per 1,000 sq. ft. floor area + 1 per 1,000 sq. ft. of outdoor sales, display	1 per 500 sq. ft. floor area + 1 per 500 sq. ft. of outdoor sales, display	1 per 4,000 sq. ft. interior floor area

Use	Minimum	Maximum	Bicycle
Business sales and services	1 per 400 sq. ft. floor area	1 per 200 sq. ft. floor area	1 per 2,000 sq. ft. floor area
Copy shop	1 per 400 sq. ft. floor area	1 per 200 sq. ft. floor area	1 per 2,000 sq. ft. floor area
Drive-through sales and services, primary and accessory	0 or as determined by zoning administrator	as determined by zoning administrator	n/a
Dry cleaning, commercial laundry	1 per 2 employees	1.25 per employee	1 per 4,000 sq. ft. floor area
Farmers' market	0	as determined by zoning administrator	as determined by zoning administrator
Food and related goods sales	1 per 400 sq. ft. floor area	1 per 200 sq. ft. floor area	1 per 2,000 sq. ft. floor area
Furniture and household goods sales	1 per 1,000 sq. ft. floor area	1 per 500 sq. ft. floor area	1 per 5,000 sq. ft. floor area
Garden center, outdoor; Greenhouse, nursery	1 per 1,000 sq. ft. floor area + 1 per 1,000 sq. ft. of outdoor sales, display	1 per 500 sq. ft. floor area + 1 per 500 sq. ft. of outdoor sales, display	1 per 5,000 sq. ft. outdoor sales, display
Laundromat, self-service	1 per 400 sq. ft. floor area	1 per 200 sq. ft. floor area	1 per 2,000 sq. ft. floor area
Liquor store	1 per 400 sq. ft. floor area	1 per 200 sq. ft. floor area	1 per 2,000 sq. ft. floor area
Mortuary, funeral home	1 per 200 square feet of assembly area	1 per 100 square feet of assembly area	1 per 2,000 sq. ft. assembly area
Outdoor uses, commercial	1 per 1,000 sq. ft. of outdoor sales, display	1 per 500 sq. ft. of outdoor sales, display	1 per 5,000 sq. ft. outdoor sales, display
Package delivery service	1 per 400 sq. ft. floor area	1 per 200 sq. ft. floor area	1 per 2,000 sq. ft. floor area
Payday loan business	1 per 400 sq. ft. floor area	1 per 200 sq. ft. floor area	1 per 2,000 sq. ft. floor area
Pet daycare	1 per 15 clients	200% minimum	1 per 5,000 sq. ft. floor area
Post office	1 per 400 sq. ft. floor area	1 per 200 sq. ft. floor area	1 per 2,000 sq. ft. floor area
Secondhand goods sales	1 per 400 sq. ft. floor area	1 per 200 sq. ft. floor area	1 per 2,000 sq. ft. floor area
Service business; service business with showroom or workshop	1 per 400 sq. ft. floor area	1 per 200 sq. ft. floor area	1 per 2,000 sq. ft. floor area
Small appliance repair; small engine repair	1 per 2 employees	1 per employee	1 per 2,000 sq. ft. floor area
Food and Beverages			
Catering	1 per 2 employees	1 per employee	1 per 5 employees
Coffee shop, tea house	15% of capacity of persons	30% of capacity of persons	5% of capacity of persons
Restaurant, carry-out, deli (no liquor sales), restaurant-tavern, tavern, brewpub	20% of capacity of persons	40% of capacity of persons	5% of capacity of persons
Commercial Recreation, Entertainment and Lodging			
Bed and breakfast establishment	1 per 2 bedrooms in addition to requirement for dwelling	200% of minimum	1 per 2 bedrooms

Use	Minimum	Maximum	Bicycle
Health/sports club	10% of the capacity of persons	20% of the capacity of persons	5% of the capacity of persons
Hostel	0	1 per bedroom	1 per bedroom
Hotel, inn, motel	.75 per bedroom	2 per bedroom	1 per 10 bedrooms
Indoor recreation	as determined by zoning administrator (number employees & use characteristics)	as determined by zoning administrator	5% of the capacity of persons
Lodge, private club, reception hall	20% of the capacity of persons	40% of the capacity of persons	5% of the capacity of persons
Outdoor recreation (i.e., mini-golf, driving range, etc.)	as determined by zoning administrator	as determined by zoning administrator	as determined by zoning administrator
Theater, assembly hall, concert hall	20% of the capacity of persons in the auditorium, or as established in campus master plan (if applicable)	40% of the capacity of persons in the auditorium	5% of the capacity of persons in the auditorium
Adult Entertainment			
Adult use, adult entertainment tavern	20% of capacity in persons	40% of capacity	5% of capacity
Automobile Services			
Auto service station, body shop, repair station	1 per 2,000 sq. ft. of floor area excluding service bays + 2 spaces per service bay	1 per 1,000 sq. ft. of floor area excluding service bays + 2 spaces per service bay	1 per 5 employees
Auto convenience market	1 per 1,000 sq. ft. of floor area	1 per 500 sq. ft. of floor area	1 per 1,000 sq. ft. floor area
Auto sales and rental Note: rental vehicles on site may be stacked	1 per 1,000 sq. ft. floor area + 2 spaces per service bay, if any	1 per 500 sq. ft. floor area + 4 spaces per service bay	1 per 5 employees
Automobile storage and towing (excluding wrecked or junked vehicles)	as determined by zoning administrator (number trucks and storage area size)	as determined by zoning administrator	1 per 5 employees
Car wash	as determined by zoning administrator	as determined by zoning administrator	1 per 5 employees
Public Utility and Public Service Uses			
Electric power production (principal use)	as determined by zoning administrator	as determined by zoning administrator	1 per 10 employees
Electric substations, gas regulator stations, telecommunications facilities, sewerage system lift stations, water pumping stations and other public utility uses	0	as determined by zoning administrator	-
Transportation Uses			
Bus or railroad passenger depot, railroad or intermodal freight yard, motor freight terminal, railroad yard or shop, taxi dispatching, maintenance and storage	0	as determined by zoning administrator	1 per 10 employees

Use	Minimum	Maximum	Bicycle
Limited Production, Processing and Storage			
Artisan workshop	0	1 per employee/artist	1 per 5 employees
Bakery, wholesale	1 per 2 employees	1 per employee	1 per 5 employees
Bottling plant	1 per 2 employees	1 per employee	1 per 10 employees
Contractor's yard	1 per 500 sq. ft. office or sales area + 1 per 3,000 sq. ft. storage area	1 per 250 sq. ft. office or sales area + 1 per 1,500 sq. ft. storage area	1 per 5,000 sq. ft. floor area
Laboratories - research, development and testing	1 per 2 employees	1 per employee	1 per 2,500 sq. ft. floor area
Limited production and processing	1 per 2 employees	1 per employee	<u>1 per 5 employees</u>
Mail order house	1 per 2 employees	1 per employee	1 per 10 employees
Printing and publishing	1 per 2 employees	1 per employee	1 per 10 employees
Recycling collection center, drop-off station	1 per 2 employees	1 per employee	1 per 10 employees
Storage - personal indoor facility	0	1 per employee	1 per 10 employees
Industrial Uses			
Light manufacturing	1 per 2 employees	1 per employee	1 per 10 employees
General manufacturing	1 per 2 employees	1 per employee	1 per 10 employees
Asphalt, concrete batching or ready-mix plant	as determined by zoning administrator	as determined by zoning administrator	1 per 10 employees
Brewery	1 per 2 employees	1 per employee	1 per 10 employees
Concrete, asphalt and rock crushing facility	0	0	1 per 10 employees
Extraction of gravel, sand, other raw materials	0	0	1 per 10 employees
Lumberyard	1 per 1,000 sq. ft. floor area + 1 per 1,000 sq. ft. of outdoor sales, display	1 per 500 sq. ft. floor area + 1 per 500 sq. ft. of outdoor sales, display	1 per 10 employees
Motor vehicle salvage	as determined by zoning administrator	as determined by zoning administrator	1 per 10 employees
Hazardous waste collection, storage or transfer	1 per 2 employees	1 per employee	1 per 10 employees
Recycling center	1 per 2 employees	1 per employee	1 per 10 employees
Agricultural Uses			
Cultivation	0	1 per employee	1 per 5 employees
Animal husbandry	0	1 per employee	1 per 5 employees
Intensive agriculture	as determined by zoning administrator	as determined by zoning administrator	1 per 5 employees
On-site agricultural retail, farm stand	as determined by zoning administrator	as determined by zoning administrator	as determined by zoning administrator

(3) Adjustments to Minimum Number of Required Spaces

Where minimum parking is required, the following adjustments may be made, in addition to the parking waiver specified under Section (2)(B).

- A. Transit corridor reduction. Within six hundred (600) feet of a high-frequency transit corridor, as defined, the Plan Commission may authorize a reduction in minimum parking requirements of up to twenty-five percent (25%), depending on frequency of transit service and adequacy of pedestrian and bicycle linkages to transit stops or stations.
- B. Shared parking reduction. The zoning administrator may authorize a reduction in the minimum parking number of parking spaces required upon a determination that the hours of peak use among multiple uses will result in lower parking demand, using the method outlined in Subsection ___.
- C. Parking reduction request. A reduction in the minimum number of parking spaces required may be granted through the following procedures:
 - 1. A reduction of up to twenty (20) spaces may be approved by the zoning administrator.
 - 2. A reduction of more than twenty (20) spaces but less than twenty-five percent (25%) of the required parking may be approved by the Director.
 - 3. A reduction of more than twenty (20) spaces and twenty-five percent (25%) or more of the required parking must be reviewed by the Plan Commission as a conditional use.

A parking reduction request must be initiated by the owner, who must submit information to support the argument for reducing the required number of spaces.

- D. Bicycle parking reduction. The amount of bicycle parking required may be reduced under the following circumstances:
 - 1. If more than fifty (50) bicycle parking spaces are required, the required spaces above fifty (50) may be reduced by one-half (1/2).
 - 2. If site constraints make it infeasible to provide sufficient bicycle parking on site, the required amount may be reduced or waived by the zoning administrator.
 - 3. If permission has been granted to locate required bicycle parking in the public right-of-way, those spaces may contribute to the minimum requirement.
 - 4. Public bicycle parking spaces within three hundred (300) feet may be counted toward compliance with required bicycle parking.
- E. Shared car reduction. A reduction in residential parking may be approved by the zoning administrator is a shared or community car is available on or within reasonable proximity of the site, for use by

residents.

- F. Off-site parking. Parking for nonresidential uses may be reduced by one space for each space in a public parking lot or public parking structure located within one thousand three hundred twenty (1,320) feet of the use, as measured by using the shortest pedestrian route from the nearest corner of the parking lot or structure to the main public entrance of the use served.
- G. Deferral of required parking spaces. Any applicant may seek permission to defer installation of all or a portion of the required parking until such parking is needed; however, the site plan shall depict the minimum number of required parking spaces.
 - 1. Single-family or two-family dwelling may defer construction of required parking and driveway until desired. Parking and driveway locations meeting all requirements must be shown on an approved site plan.
- H. Substitution by moped parking. Moped parking is not required. However, three (3) moped spaces may be substituted for one (1) required automobile parking space. Where provided, moped parking shall meet the standards in Sub. ___.
- I. Substitution by bicycle parking. Four (4) bicycle parking spaces above the minimum number required may be substituted for one (1) required automobile parking space.

(4) Exceptions to Exceed Maximum Number of Spaces

Parking exceeding the maximum may be allowed as a conditional use, provided that the additional parking is underground or enclosed and that the following factors are considered, in addition to the criteria of Section 28.1103.

- A. Documentation regarding the actual parking demand for the proposed use.
- B. The impact of the proposed use on the parking and roadway facilities in the surrounding area.
- C. Whether the proposed use is located near a parking area that is available to the customers, occupants, employees and guests of the proposed use.
- D. The availability of alternative forms of transportation and actions being taken by the applicant to enhance or promote those alternatives.
- E. Structured parking, rain gardens or other bioretention facilities, additional landscaping, pervious pavement, or other mitigation measures may be required as conditions for an exception.

(5) Shared Parking Requirements

The zoning administrator may authorize a reduction in the total number of required parking spaces for two or more uses jointly providing off-street parking when their respective hours of peak operation do not overlap. Shared parking shall be subject to the location requirements of Section 3.F above and the following conditions:

- A. Computation. The number of shared spaces for two or more

distinguishable land uses shall be determined by the following procedure:

1. Multiply the minimum parking required for each individual use, as set forth in Table 28J-2, Specific Off-Street Parking Provisions, by the appropriate percentage indicated in the table, for each of the six (6) designated time periods.
 2. Add the resulting sums for each of the six (6) columns.
 3. The minimum parking requirement shall be the highest sum among the six (6) columns resulting from the above calculations.
 4. Select the time period with the highest total parking requirement and use that total as the shared parking requirement.
- B. Other uses. If one or more of the land uses proposing to make use of shared parking facilities do not conform to the general land use classifications in Table 28J-2, Shared Parking Calculations, as determined by the zoning administrator, the applicant shall submit sufficient data to indicate the principal operating hours of the uses. Based upon this information, the zoning administrator shall determine the appropriate shared parking requirement, if any, for such uses.
- C. Alternative procedure. An application may be submitted requesting that the zoning administrator authorize a greater reduction in the total number of required parking spaces for two (2) or more uses where an applicant believes that Table 28J-2, Shared Parking Calculations, does not adequately account for circumstances unique to the particular property or properties in question.

The application shall include, at a minimum, a parking study with a detailed description of the proposed uses, their hours of operation, their anticipated peak parking demand, and anticipated hours that such peak parking demand would occur. Based upon this information, the zoning administrator may authorize a greater parking reduction than is authorized by Table 28J-2, Shared Parking Calculations. The zoning administrator may impose reasonable conditions to mitigate potential negative effects.

Table 28J-2: Shared Parking Calculations

General Land Use Classification	Weekdays			Weekends		
	2:00 a.m. -- 7:00 a.m.	7:00 a.m. -- 6:00 p.m.	6:00 p.m.-- 2:00 a.m.	2:00 a.m.-- 7:00 a.m.	7:00 a.m. -- 6:00 p.m.	6:00 p.m.-- 2:00 a.m.
Office/Warehouse/Industrial	5%	100%	5%	0%	10%	0%
Retail sales and services	0%	90%	80%	0%	100%	60%
Restaurant (not 24 hour)	10%	70%	100%	20%	70%	100%
Residential	100%	60%	100%	100%	75%	90%
Theater	0%	40%	90%	0%	80%	100%
Hotel: guest rooms (calculate conference and restaurant facilities separately)	100%	55%	100%	100%	55%	100%
Conference / Convention Facilities	0%	100%	100%	0%	100%	100%

General Land Use Classification	Weekdays			Weekends		
	2:00 a.m. -- 7:00 a.m.	7:00 a.m. -- 6:00 p.m.	6:00 p.m.-- 2:00 a.m.	2:00 a.m.-- 7:00 a.m.	7:00 a.m. -- 6:00 p.m.	6:00 p.m.-- 2:00 a.m.
Place of Worship	0%	25%	50%	0%	100%	50%
School, Grades K-12	0%	100%	25%	0%	30%	10%
Community Center, Library, Museum	0%	100%	80%	0%	100%	80%

- D. The shared parking spaces shall be maintained as long as the uses they serve are in operation.
- E. The required number of bicycle parking spaces will be provided.
- F. The property owner or owners shall sign and record, with the Dane county register of deeds, a written agreement in a form satisfactory to the city attorney, which states that there will be no substantial change in the use or occupancy of the property or properties that will increase the demand for parking in the shared parking facility. This agreement shall also include a statement that the property owner or owners and their tenants shall be provided access to, and use of, the shared parking facility. A copy of the agreement shall be filed with the Director.

(6) Parking Design and Location

Parking for automobiles and other motor vehicles shall be designed according to the requirements of Section 10.08, Madison General Ordinances and the following standards.

- A. Surfacing. All parking lots and driveways shall have paved or approved surfaces, as required in Section 10.8, MGO. The use of permeable paving, as defined, is encouraged for all parking spaces provided above the minimum number required by this chapter.
 - 1. Residential drives serving single- to two-family dwellings may contain a grass center provided that the areas on which the vehicle’s wheels touch are a minimum of twelve (12) to eighteen (18) inches in width.
- B. Snow removal. In winter months, required parking areas, including bicycle parking areas, shall be cleared of snow within a reasonable time. Areas used for snow storage shall be approved by the zoning administrator.
- C. Residential Parking Locations (see illustrations A, B,C).
 - 1. Parking is not permitted within front yard setbacks, or any street side yard setback, including the side yard setback extension into the rear yard, except on a driveway meeting the standards of Section 7 below.
 - 2. Parking shall not be located on street terraces, driveways, or any other areas located within a public right-of-way not explicitly designated by the Director of Public Works.
 - 3. Parking spaces may be located within:
 - a. an interior side yard setback;
 - b. a rear yard setback, with a minimum separation of three

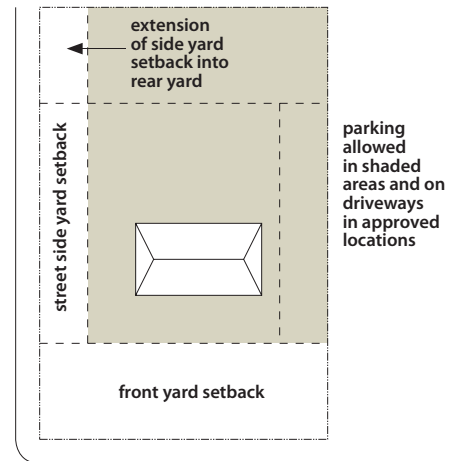

A. Parking locations on residential corner or reversed corner lot

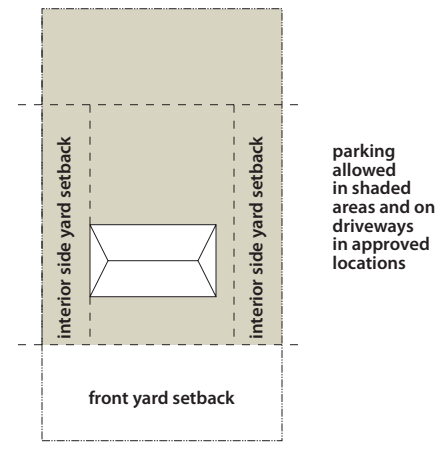

B. Parking locations on interior lot

(3) feet from a street right-of-way (on a corner or reversed corner lot);

d. within the building envelope.

4. Parking on a through lot. Through lots are defined as having two (2) front yards and no rear yard. Parking on a through lot may be located within the building envelope, or an interior side yard setback, but not in either front yard setback.
5. A maximum of forty percent (40%) of the front and rear yard setbacks may be paved and used for driveway and parking purposes. Lot coverage requirements also apply to residential lots.

D. Landscaping and Screening. All off-street parking areas shall be landscaped according to the standards of Section 28J.0812, with the exception of parking for single-family detached, two-family and three-family dwellings.

(7) Residential Driveway Design and Location

Driveways shall be designed according to the requirements of Section 10.08, Madison General Ordinances and the following standards.

- A. Driveways shall be a minimum of eight (8) feet in width, except where otherwise specified in Section 10.08.
- B. Driveways may be located in the following locations:
 1. Within a front yard setback or street side yard setback, including the extension of the side yard setback into the rear yard setback (see illustrations D and E). The driveway must lead only from a street to the nearest garage or to a paved or graveled parking area located in compliance with Subsection 6.C above. Maximum driveway width is the width of the garage entrance or parking area, up to a maximum of twenty-two (22) feet.
 2. Within an interior side yard setback, leading to a garage or parking area located in compliance with Subsection 6.C above (see illustration D). Maximum driveway width is ten (10) feet, which shall not be exceeded within the front yard setback. No setback between the driveway and the side lot line is required.
- D. Two driveways may be constructed within a front yard setback or, on a corner lot, within the street side yard setback, including the extension of the side yard setback into the rear yard setback, if the following standards are met (see illustration F):
 1. Each driveway is a maximum of eleven (11) feet wide, or ten (10) feet within an interior side yard setback.
 2. Both driveways meet at a point outside the required front, street side or side yard extension setbacks.
 3. Both driveways lead to the same garage or to a paved or graveled parking area located in compliance with Subsection C above.

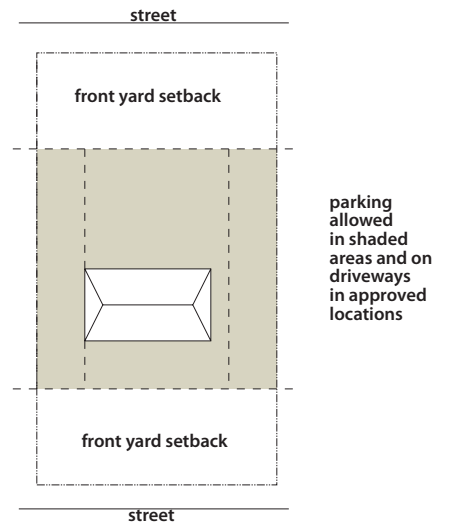

C. Parking locations on through lot

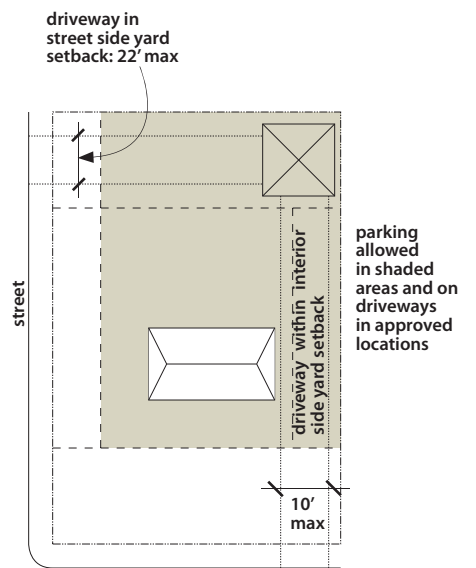

D. Interior and street side yard driveway examples; detached garage

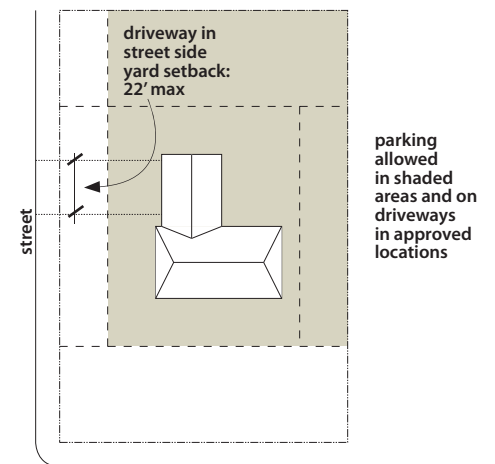

E. Street side yard driveway example; attached garage

- D. Two driveways may be constructed to serve twin dwellings (two-family dwellings separated by a common wall). Each dwelling may have one driveway that meets the requirement of Par. C, above, with a maximum width equal to the width of the garage entrance or parking area, not to exceed twenty-two (22) feet.
- E. A maximum of two (2) curb cuts are permitted for any residential lot.
- E. Driveways may be shared between two single- or two-family lots, provided that appropriate easements or other agreements are established. Shared driveways shall meet the minimum and maximum width requirements of this section.
- F. Driveways shall be oriented in a perpendicular fashion to the street from which they take access, and shall cross required setbacks in a perpendicular fashion, to the extent feasible.
- G. Driveways serving commercial or industrial uses shall not cross residentially-zoned properties, except where allowed by conditional use.

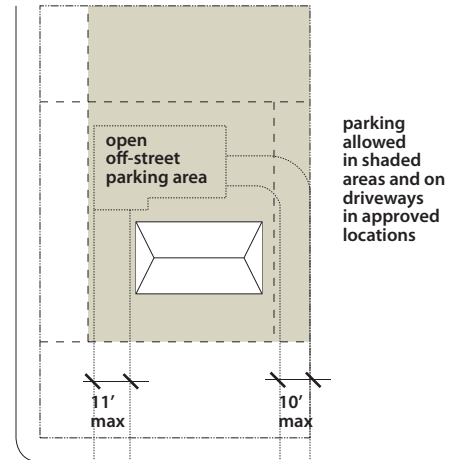

(8) Restrictions on Residential Parking

F. Two driveways on a residential lot

- A. A maximum of one (1) commercial vehicle per dwelling unit may be parked outdoors on residential property if the vehicle is:
 - 1. Used by a resident of the dwelling unit;
 - 2. Has a manufacturer's gross vehicle weight rating of ten thousand (10,000) pounds or less and is less than twenty-one (21) feet in length.
- B. Vehicles and/or equipment not normally associated with a residential use are specifically prohibited from being parked or stored outdoors on residential property. Such vehicles include, but are not limited to:
 - 1. Construction equipment, such as bulldozers, backhoes, skid steers, and fork lifts
 - 2. Dump and stake body style trucks
 - 3. Cube type vans and trucks
 - 4. Landscaping business equipment such as tractors, tree spades, graders and scrapers
 - 5. Semi-trailers and tractors
 - 6. Concession, vending and catering trailers
 - 7. Commercial/Industrial equipment trailers and lifts
 - 8. Tow trucks, wreckers or car carriers
- C. A recreational vehicle (RV) associated with residential uses may be parked as a passenger vehicle but shall not be utilized for living space or storage of goods, materials or equipment other than is considered part of the RV or essential to its function.
- D. All vehicles parked on a residential lot shall display current license plates and be in safe, functional and operable condition.

(9) Bicycle Parking Design and Location

- A. Parking designation. Bicycle parking requirements are as shown in Table 28J-1 and shall be designated as long-term or short-term parking.
1. For all residential uses, including those in combination with other uses, at least ninety percent (90%) of resident bicycle parking shall be designed as long-term parking. Any guest parking shall be designed as short-term parking.
 2. For all other uses, at least fifty percent (50%) of all bicycle parking shall be designed as short-term parking.
- B. Required short-term bicycle parking spaces shall be located in a convenient and visible area within fifty (50) feet of a principal entrance and shall permit the locking of the bicycle frame and one (1) wheel to the rack and shall support a bicycle in a stable position.
- C. Required long-term bicycle parking spaces shall be located in enclosed and secured or supervised areas providing protection from theft, vandalism and weather and shall be accessible to intended users. Required long-term bicycle parking for residential uses shall not be located within dwelling units or within deck or patio areas accessory to dwelling units. With permission of the zoning administrator, long-term bicycle parking spaces for non-residential uses may be located off-site within three hundred (300) feet of the site. No fee shall be charged for long-term resident bicycle parking.
- D. Bicycle parking spaces shall be two and one-half (2½) by six (6) feet in size. Each required bicycle parking space must be accessible without moving another bicycle and its placement shall not result in a bicycle obstructing a required walkway. Bicycle racks shall be installed to the manufacturer's specifications, including the minimum recommended distance from other structures.

(10) Moped Parking Design and Location

Where moped or scooter off-street parking is provided, it shall meet the following standards:

- A. Spaces shall be three (3) feet by six (6) feet in size with a vertical clearance of six (6) feet and with a drive aisle of five (5) to six (6) feet.
- B. The spaces may be located close to bicycle parking areas but kept separate and out of the way of conflict with other motor vehicle traffic. Moped parking shall not be located within front yard setback areas.
- C. Spaces shall be located and access should be provided such that the use or crossing of pedestrian facilities, including wheelchair ramps, by mopeds is discouraged and such that mopeds do not come into conflict with pedestrians or the users of wheelchairs.
- D. Access to moped areas should be provided using a separate driveway via a curb cut and ramp or mountable curb with a reduced slope after taking into account traffic movements on the street from which safe access must be provided.
- E. Moped driveways may cross a sidewalk as may any driveway but

must not use the sidewalk to provide access to moped stalls. Moped parking areas behind a sidewalk should be separated by a curb when possible.

(11) Off-Street Loading Requirements

Any use which has a gross floor area of ten thousand (10,000) square feet or more, and which requires deliveries or makes shipments, shall provide off-street loading facilities in accordance with the regulations of this Section.

- A. Location. All loading berths shall be located twenty-five (25) feet or more from the intersection of two street right-of-way lines. Loading berths shall not be located within any required front yard or street side yard setback area. All loading areas shall be located on private property and shall not be located within, or interfere with, any public right-of-way.
- B. Required number of spaces are based on the size of the establishment as follows:

Size of establishment	Number of loading spaces
Office buildings and lodging:	
10,000 to 50,000 sq. ft. GFA	1 loading space
50,001 to 200,000 sq. ft. GFA	2 loading spaces
over 200,000 sq. ft. GFA	2 + 1 additional space per each 75,000 sq. ft. GFA above 200,000
Retail, service, commercial, wholesale and industrial uses	
10,000 to 20,000 sq. ft. GFA	1 loading space
20,001 to 100,000 sq. ft. GFA	2 loading spaces
over 100,000 sq. ft. GFA	2 + 1 additional space per each 75,000 sq. ft. GFA above 100,000

- C. Size of spaces. A required off-street loading space shall be at least ten (10) feet wide by at least thirty-five (35) feet in length for structures less than twenty thousand (20,000) square feet in gross floor area, and at least ten (10) feet wide by fifty (50) feet in length for larger structures. The above areas shall be exclusive of aisle and maneuvering space, and shall have a vertical clearance of at least fourteen (14) feet.
- D. Shared loading. Two or more uses on adjacent zoning lots may share a loading area.
- E. Uses for which off-street facilities are otherwise required but which are located in structures of less than twenty thousand (20,000) square feet of floor area may use drive aisles or other suitable areas on the same lot for loading purposes.
- E. Surfacing. All open off-street loading areas shall be paved with a bituminous pavement or Portland cement concrete pavement in accordance with City of Madison standards and specifications.

28J-0812 Landscaping and Screening Requirements

(1) Statement of Purpose

The landscaping and screening requirements specified in this section are intended to:

- A. Protect and restore the natural environment throughout the development process.
- B. Reduce the negative environmental effects of development while fostering aesthetically pleasing development which will protect and enhance the appearance, character, health, safety and welfare of the community.
- C. Reduce the “heat island” effect of impervious surfaces such as parking lots by cooling and shading the surface area.
- D. Increase the compatibility of adjacent uses, by minimizing adverse impacts of noise, dust and other debris, motor vehicle headlight glare or other artificial light intrusions and other objectionable views, activities or impacts to adjacent or surrounding uses.

(2) Applicability

The following standards apply to all exterior construction and development activity, including the expansion of existing buildings, structures and parking lots, except the construction of detached single-family and two-family dwellings and their accessory structures.

(3) Landscape Plan and Design Standards

Landscape plans shall be submitted as a component of a site plan, where required, or as a component of applications for other actions, including zoning permits, where applicable. Landscape plans for zoning lots greater than ten thousand (10,000) square feet in size must be prepared by a registered landscape architect.

Overall composition and location of landscaped areas shall complement the scale of the development and its surroundings. In general, larger, well-placed contiguous planting areas shall be preferred to smaller, disconnected areas.

- A. Elements of the landscape plan shall include the following:
 - 1. Plant list including common and Latin names;
 - 2. Site amenities, including bike racks, benches, trash receptacles, etc.;
 - 3. Storage areas;
 - 4. Lighting (landscape, pedestrian or parking area);
 - 5. Irrigation;
 - 6. Hard surface materials;
 - 7. Labeling of mulching, edging and curbing;

- 8. Areas of seeding or sodding;
 - 9. Areas to remain undisturbed and limits of land disturbance;
 - 10. Plants shall be depicted at two-thirds ($\frac{2}{3}$) maturity.
- B. Plant selection. Plant materials provided in conformance with the provisions of this section shall be of nursery quality and tolerant of individual site microclimates. Preferred and prohibited plant materials are listed in Appendix __ [TBA]
- N. Mulch shall consist of shredded bark or chipped wood or other organic material. Landscape stone mulch and weed barriers are prohibited.

(4) Vision Clearance at Corners

In order to provide a clear view of intersecting streets to motorists, a triangular area of clear vision formed by the two intersecting streets and driveways and a line connecting said centerlines, shall be kept clear of visual obstruction, as specified below.

- A. Where two streets intersect, the line shall extend a minimum of twenty-five (25) feet from the intersection of the two street property lines.
- B. At the intersection of a private drive or alley with a street, the line shall extend a minimum of ten (10) feet from the intersection of the street and alley or drive property lines.
- C. At the intersection of any railroad crossing with a street or highway, a vision clearance triangle with a minimum dimension of three hundred thirty (330) feet shall be maintained.
- D. Within any vision clearance triangle, screening, planting, walls, fences or other obstructions are not permitted between a height of thirty (30) inches and ten (10) feet above the curb level, with the exception of fences a maximum of three (3) feet in height and at least two-thirds ($\frac{2}{3}$) open to vision.
- E. Dimensions of the vision clearance triangle may be reduced based on the recommendation of the Traffic Engineering Division.

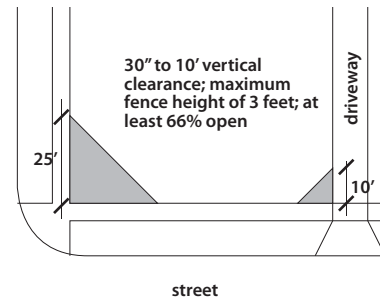

Vision clearance triangles for street and driveway

(5) Landscape Calculations and Distribution

Required landscaped areas shall be calculated based upon the total developed area of the property. Developed area, for the purpose of this requirement, is defined as all parts of the site that are not left in a natural state within a single contiguous boundary, including building footprints, parking and loading areas, driveways, internal sidewalks, patios, and outdoor activity areas. Developed area does not include other land within required setbacks and natural areas on the same property that are left undisturbed.

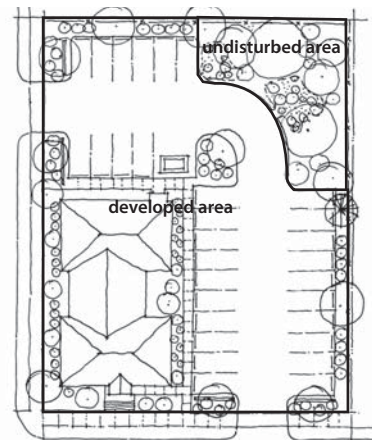

Total Developed Area

- A. One (1) landscape unit shall be provided for each three hundred (300) square feet of developed area, with the exception of the IL and the IG districts as specified in B. below.
- B. Within the Industrial - Limited and Industrial - General districts, one (1) landscape unit shall be provided for every six hundred (600) square feet of developed area.

C. One landscape unit consists of five (5) landscape points. Landscape points are calculated as shown in the following table.

Plant type	Points	Minimum Size at Installation
Overstory deciduous tree	35	2 inch caliper
Ornamental tree	15	1 1/2 inch caliper
Evergreen tree	15	3 feet tall
Shrub, deciduous	2	18" or 3 gallon container size
Shrub, evergreen	3	18" or 3 gallon container size
Ornamental grasses	2	18" or 3 gallon container size
Ornamental/decorative fencing or wall	4 per 10 ln. ft.	n/a

- D. Calculations yielding a fraction up to one-half (½ or 0.5) shall be rounded down to the nearest whole number; fractions of more than one half (½) shall be rounded up.
- E. Landscaping shall be distributed throughout the property along street frontages, within parking lot interiors, and as foundation plantings as specified in subsections (6) through (8) below, or as general site landscaping.
- F. Planting beds or planted areas must have at least seventy-five percent (75%) vegetative cover. Non-planted areas shall not be paved, but shall be covered with a weed barrier and mulched.
- G. Additional landscaping requirements may be specified by the Plan Commission for conditional uses.



Development Frontage Landscaping

(6) Development Frontage Landscaping

Landscaping and ornamental fencing shall be provided between buildings or parking areas and the adjacent street(s), except where buildings are placed at the sidewalk. Landscape material shall include a mix of trees, shrubs and groundcover, meeting the following requirements:

- A. One (1) overstory deciduous tree and five (5) shrubs shall be planted for each thirty (30) lineal feet of lot frontage. Two (2) ornamental trees or two (2) evergreen trees may be used in place of one (1) overstory deciduous tree.
- B. In cases where building facades directly abut the sidewalk, required frontage landscaping shall be deducted from the required point total.
- C. In cases where development frontage landscaping cannot be provided due to site constraints, the zoning administrator may waive the requirement or substitute alternative screening methods for the required landscaping.
- D. Fencing shall be a minimum of three (3) feet in height, and shall be constructed of wrought iron, masonry, stone or equivalent material. Chain link or temporary fencing is prohibited.

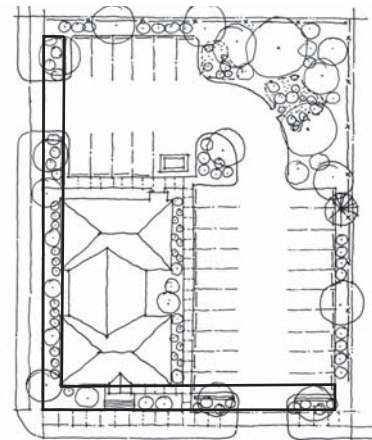

(7) Interior Parking Lot Landscaping

The purpose of interior parking lot landscaping is to improve the appearance of parking lots, provide shade, and improve stormwater infiltration. All parking lots with twenty (12 also considered) or more parking spaces shall be

landscaped in accordance with the following interior parking lot standards.

- A. A minimum of five percent (5%) of the asphalt or concrete area of the parking lot shall be devoted to interior planting islands or peninsulas. The planting islands shall contain a minimum of one hundred sixty (160) square feet and be a minimum of nine (9) feet in width.
- B. The primary plant materials shall be shade trees with at least one (1) deciduous canopy tree for every one hundred sixty (160) square feet of landscaped area. Two (2) ornamental trees may be substituted for one (1) canopy tree, but ornamental trees shall constitute no more than 25% of the required trees. Islands shall include shrubs, ornamental grasses, or other vegetative ground cover between required trees.
- C. Islands may be curbed or may be designed as uncurbed bio-retention areas as part of an approved low impact stormwater management design approved by the Director of Public Works. The ability to maintain these areas over time must be demonstrated. (See Article 37, MGO, Erosion and Stormwater Runoff Control.)

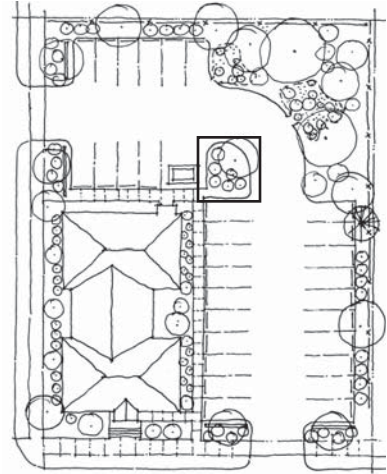

(8) Foundation Plantings

Foundation plantings consist primarily of shrubs and native grasses, and shall be installed along building facades, except where building facades directly abut the sidewalk (a zero setback).



(9) Screening along District Boundaries

Screening shall be provided along side and rear property boundaries between commercial, mixed use or industrial districts and residential districts. Screening shall consist of a solid wall, solid fence, or hedge with year-round foliage, between six (6) and eight (8) feet in height, except that within the front yard setback area, screening shall not exceed four (4) feet in height. Height of screening shall be measured from natural or approved grade. Berms and retaining walls shall not be used to increase grade relative to screening height.



(10) Screening of Other Site Elements

The following site elements shall be screened in compatibility with the design elements, materials and colors used elsewhere on the site, as follows:

- A. Refuse disposal areas. All developments, except single family and two family developments, shall provide a refuse disposal area. Such area shall be screened on four (4) sides (including a gate for access) by a solid, commercial-grade wood fence, wall, or equivalent material with a minimum height of six (6) feet and not greater than seven (7) feet.
- B. Outdoor storage areas. Outdoor storage areas shall be screened from abutting residential uses with a by a building wall or solid, commercial-grade wood fence, wall, year-round hedge, or equivalent material, with a minimum height of six (6) feet and not greater than seven (7) feet. Screening along district boundaries, where present, may provide all or part of the required screening.
- C. Loading areas. Loading areas shall be screened from abutting residential uses and from street view to the extent feasible by a

Interior Parking Lot Landscaping

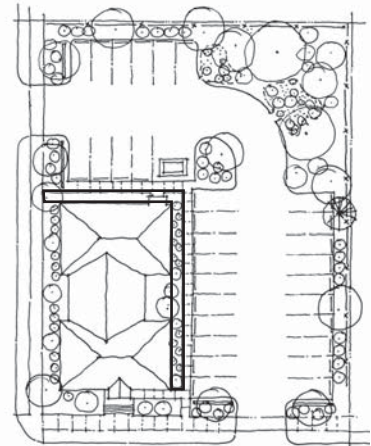

Foundation Plantings

building wall or solid, commercial-grade wood fence, or equivalent material, with a minimum height of six (6) feet and not greater than seven (7) feet. Screening along district boundaries, where present, may provide all or part of the required screening.

- D. Mechanical equipment. All rooftop and ground level mechanical equipment and utilities shall be fully screened from view from any street or residential district, as viewed from six (6) feet above ground level. Screening may consist of a building wall or fence and/or landscaping as approved by the zoning administrator.

(11) Maintenance

The owner of the premises is responsible for the watering, maintenance, repair and replacement of all landscaping, fences, and other landscape architectural features on the site. All planting beds shall be kept weed free. Plant material that has died shall be replaced within twelve (12) months.

(12) Fences, Walls and Hedges

Fences, walls and hedges may be erected, placed, or maintained in any yard along or adjacent to a lot line in accordance with the requirements identified in this section. The owner shall be responsible for properly locating all property lines before construction of any fence.

- A. Height in residential districts.
 - 1. The maximum height of a fence or hedge within required side and rear setbacks in a residential zoning district shall not exceed six (6) feet. A fence of up to eight (8) feet in height may be constructed on a district boundary line between a residential district and a mixed-use, commercial or employment district.
 - 2. Fences around pools shall not exceed eight (8) feet.
 - 3. The maximum height of a solid fence or hedge within a required front or corner side yard setback shall not exceed four (4) feet, except that a fence or hedge of up to six (6) feet may be located within a corner side yard setback behind the rear plane of the principal building. Screening fences exceeding four (4) feet in height shall be set back a minimum of four (4) feet from the sidewalk.
 - a. Such front yard or corner side yard fences may be increased to a maximum height of five (5) feet if open, decorative, ornamental fencing materials that are less than fifty (50) percent opaque are used or to a maximum height of six (6) feet if open, decorative, ornamental fencing materials that are less than twenty (20) percent opaque are used.
- B. Height in mixed use or nonresidential zoning districts. The maximum height of a fence or wall shall not exceed eight (8) feet except in required front or corner side yard setbacks where the maximum height of a solid fence or wall shall not exceed three (3) feet.
- C. Height measurement. Fence height shall be measured from natural or approved grade. In the case of grade separation, such as the division of properties by a retaining wall, fence height shall be

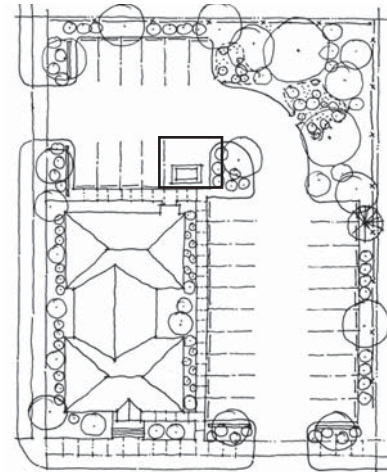

Screening of Other Site Elements

Fence Definition: An enclosure or barrier, such as wooden posts, wire, iron, or other manufactured material or combination of materials erected to enclose, screen or separate areas.

determined based on measurement from the average point between highest and lowest grade. If the fence is set back from the retaining wall by a distance of at least four (4) feet, the fence height shall be measured from the base of the fence.

- D. Fences or walls shall comply with the vision clearance triangle requirements of Subsection ____.
- E. Fences and walls located in the front or street side yard setback areas must be made of materials such as wood, ornamental metal, brick, vinyl-coated chain link or stone. Uncoated chain link fences may be used in interior side or rear yards.
- F. Temporary fencing, including the use of wood or plastic snow fences for the purposes of limiting snow drifting between November 1 and April 1, protection of excavation and construction sites, and the protection of plants during grading and construction is permitted for a time period consistent with an approved building permit or up to one hundred eighty (180) consecutive days per calendar year.

28J.0813 Telecommunication Facilities and Antennas

(1) Intent

The purpose and intent of this section is to strike a balance between the federal interest concerning the construction, modification and siting of telecommunication towers and antennas for use in providing personal wireless services, and the interest of the City in regulating local zoning. these regulations are designed to protect and promote the public health, safety and welfare of the community and the aesthetic quality of the City. The goals of this section are to:

- A. Protect residential areas and land uses from the potential adverse impacts of towers and antennas;
- B. Minimize the total number of towers throughout the community;
- C. Encourage the joint use of new and existing tower sites as a primary siting option rather than construction of additional single-use towers;
- D. Minimize the visual impact of towers and antennas; and avoid potential damage to adjacent properties from tower failure through engineering and careful siting of tower structures.

It is also the intent of this section to provide a public forum to insure a balance between public concerns and private interests in establishing commercial telecommunication and related facilities.

(2) Registration of Telecommunications Carriers and Providers

- A. Registration and Application Requirements. All personal wireless service carriers and providers that offer or provide any telecommunications services for a fee directly to the public, either within the City or outside the corporate limits

from telecommunications facilities within the City, and all Telecommunications tower owners, shall register and provide to the City, pursuant to this ordinance, on forms to be provided by the Neighborhood Preservation and Inspection Division Director and shall provide with each conditional use application the following information:

1. The identity and legal status of the registrant, including any affiliates.
 2. The name, address and telephone number of the officer, agent or employee responsible for the accuracy of the registration statement.
 3. A narrative and map description of registrant's existing telecommunications facilities within the City, adjacent cities, villages and townships.
 4. Such other information as the Neighborhood Preservation and Inspection Division Director may reasonably require.
- B. Purpose of Registration. The purpose of registration under this ordinance is to:
1. Provide the City with accurate and current information concerning personal wireless services carriers and providers and telecommunications tower owners, who offer or provide services within the City, or that own or operate telecommunication facilities within the City.
 2. Assist the City in enforcement of this Section.
 3. Assist the City in monitoring compliance with local, state and federal laws.
- C. Enforcement. Any personal wireless services carrier or provider who offers or provides services within the City, or any telecommunications tower owner who owns or operates telecommunications facilities within the City, must register and provide the information required in subdivision (A) above within thirty (30) days of such a request by the City.
- D. Conditional Use Application Requirements. In addition to the requirements contained in subdivision (3)A. above, the conditional use application shall address the following:
1. The requirements contained in subdivisions (5), (6), (7), (8) and (9) below, including a narrative and map description of the applicant's system-wide plan describing existing and applied for facilities to serve the community.
 2. A visual analysis, which may include photo montage, field mockup, or other techniques shall be prepared by or on behalf of the applicant which identifies the potential visual impacts and the design capacity of the proposed facility to the satisfaction of the Plan Commission.
- Consideration shall be given to views from public areas as well as from private residences. The analysis shall assess the impacts of the proposed facility and other existing telecommunication facilities in the area, and shall identify and

include all feasible mitigation measures consistent with the technological requirements of the proposed personal wireless services. All costs for the visual analysis, and applicable administrative costs, shall be borne by the applicant.

As part of the Plan Commissions continuing jurisdiction over conditional uses, each registrant shall inform the City, within sixty days, of any change in the information set forth in subdivision (3)A.

- E. Minor Alterations. Antennas affixed to an existing telecommunications tower or structure, together with the related support facilities and equipment buildings, or the replacement of a previously approved telecommunications tower and related antennas, support facilities and equipment buildings, may be authorized by issuance of a permit as a minor alteration to an existing conditional use or an existing permitted use when approved by the Director of Planning and Community and Economic Development, which are compatible with the concept approved by the City Plan Commission and/or the [conditional use] standards in sec. 28.1103 of this ordinance. If the minor alteration is not approved, the applicant shall apply to the Plan Commission for approval in accordance with the conditional use standards of this ordinance.
- F. Inventory and Tracking System. The zoning administrator shall compile a list of existing telecommunications facilities within the City's jurisdiction based upon information provided by personal wireless services providers and telecommunications tower owners. The Zoning Administrator shall maintain and update said list on a regular basis. The list shall also include the location of public facilities that may be available for co-location.
- G. A professional engineering consultant shall review each conditional use application for compliance with the requirements set out in subsections (7) and (8) below.

(3) Abandonment

If a telecommunication facility shall cease to be used for a period exceeding one year and a day, the owner or operator of said facility shall remove the facility upon the written request of the City Neighborhood Preservation and Inspection Division Director at no cost to the City within ninety (90) days of said request. Prior to the issuance of any building or zoning permits, a performance bond shall be provided to guarantee that a facility that has ceased being used for telecommunication purposes is removed. The bond amount shall be the lesser of twenty thousand dollars (\$20,000) or an amount based on a written estimate of a person qualified to remove such structures.

(4) Structural Requirements

Every telecommunication facility shall be designed and constructed so as to comply with the requirements of Secs. Comm 62.35 to 62.41, Wisconsin Administrative Code, as amended from time to time. If, upon inspection, the

Neighborhood Preservation and Inspection Division Director concludes that a tower fails to comply with such codes, in effect at the time of construction, and constitutes a danger to persons or property, then upon notice being provided to the owner of the tower, the owner shall have thirty (30) days or such time as determined by the Neighborhood Preservation and Inspection Division Director to bring such tower into compliance with said codes.

Failure to bring such tower into compliance within said thirty (30) days or such time as determined by the Neighborhood Preservation and Inspection Division Director shall constitute grounds for the removal of the tower or antenna at owner's expense.

(5) Basic Tower and Building Design

All new telecommunication facilities, except exempt facilities as defined in subsection (9), below, shall be designed to blend into the surrounding environment to the greatest extent feasible. To this end all the following measures shall be implemented.

- A. Telecommunications towers shall be constructed out of metal or other nonflammable material, unless specifically permitted by the City to be otherwise.
- B. Telecommunication support facilities (i.e., equipment rooms, utilities, and equipment enclosures) shall be constructed out of nonreflective materials (visible exterior surfaces only) to all extent possible and, where possible, shall be sited below the ridge line or designed to minimize their impact.
- C. Telecommunication equipment buildings, shelters and cabinets shall be treated to look like a building or facility typically found in the area.
- D. The City shall have the authority to require reasonable special design (materials, architectural features and color) of the telecommunication facilities where findings of particular sensitivity are made (e.g. proximity to historic or aesthetically significant structures, views and/or community features).
- E. Telecommunication facilities shall insure that sufficient anti-climbing measures have been incorporated into the facility, as needed, to reduce potential for trespass and injury.
- F. Equipment buildings and outdoor equipment shall be located, designed and screened to reduce visual impacts to the extent feasible considering the technological requirements of the proposed personal wireless services and the need to be compatible with neighboring residences and the character of the community.
- G. Emergency back-up generators shall be screened by a solid fence or wall. Other efforts to mitigate noise from such generators may be required.
- H. Antennas shall be designed to blend with its supporting structure. The color selected shall be one that in the opinion of the Plan Commission will minimize the visibility of the antennas to the greatest extent feasible

(6) Location

All new telecommunication facilities shall be located so as to minimize their visibility and the number of tower sites. To this end, a good faith effort in achieving colocation shall be required of the requestor and host entity, subject to existing co-location contracts; and all of the following measures shall be implemented for telecommunication facilities in addition to meeting the conditional use standards in sec. 28.1103 of these ordinances:

- A. No telecommunications tower shall be installed closer than one-quarter ($\frac{1}{4}$) mile from another telecommunications tower, measured from the base of the existing tower to the base of the proposed tower, unless credible evidence to a reasonable degree of certainty acceptable to the Plan Commission is submitted showing a clear need for said new tower and the infeasibility of co-locating it on an existing site. Such evidence may include but is not limited to the following:
1. A demonstration that no tower in the area that the applicant's equipment must be located is of sufficient height to meet applicant's requirements and the deficiency in height cannot be remedied at a reasonable cost;
 2. A demonstration that the existing tower is not of sufficient strength to support applicant's equipment and the deficiency in structural strength cannot be remedied at a reasonable cost;
 3. A demonstration that the applicant's equipment would cause electromagnetic interference with equipment on the existing telecommunications tower(s) within the area in which the applicant's equipment must be located, or the equipment on the existing telecommunications tower(s) would cause interference with the applicant's equipment and the interference, from whatever source, cannot be eliminated at a reasonable cost;
 4. A demonstration that the fees, costs or contractual provisions required by the owner in order to co-locate on an existing communication tower are unreasonable relative to industry norms;
 5. A demonstration that there are other factors that render existing communication towers unsuitable or unavailable and establishes that the public interest is best served by the placement or construction of a new telecommunications tower.

For the purposes of this requirement, exempt telecommunications facilities unavailable for co-location shall not be included in the one-quarter ($\frac{1}{4}$) mile computation.

- B. No telecommunication tower shall be located on a lot in a residence district, unless said lot is greater than two (2) acres in area and the principal use is other than residential.
- C. Telecommunications towers, guy wires, appurtenant equipment and

buildings shall comply with the yard and set back requirements of the zoning district in which they are located and, in addition thereto, all telecommunications towers shall be set back at least one hundred (100) feet from any property devoted to residential use or two hundred (200) feet from any residential building, whichever is less.

(7) Co-located and Multiple-User Facilities

- A. Analysis. Unless an applicant is submitting an application to locate or co-locate upon an existing tower or structure, an analysis shall be prepared by or on behalf of the applicant, subject to the approval of the Plan Commission, which identifies all reasonable, technically feasible, alternative locations and/or facilities which would be useable for the proposed personal wireless services.

The intention of the alternatives analysis is to present alternative strategies which would minimize the number, size and adverse environmental impacts, including aesthetics, of facilities necessary to provide the needed services to the City and surrounding rural and urban areas. The analysis shall address the potential for co-location at an existing or a new site and the potential to locate facilities as close as possible to the intended service area. It shall also explain the rationale for selection of the proposed site in view of the relative merits of any of the feasible alternatives.

Approval of the project is subject to the Plan Commission making a finding that the proposed site results in fewer or less severe environmental impacts, including aesthetics, than any feasible alternative site. The City may require independent verification of this analysis by a qualified engineer at the applicant's expense.

Facilities which are not proposed to be co-located with another telecommunication facility shall provide a written explanation why the subject facility is not a candidate for co-location.

- B. Design for Co-Location. All new telecommunications towers shall be structurally and electrically designed to accommodate at least three (3) separate antenna arrays, unless credible evidence is presented that said construction is economically and technologically unfeasible or the Plan Commission determines that for reasons of aesthetics or to comply with the standards of sec. 28.1103, a telecommunications tower of such height to accommodate three (3) antenna arrays is unwarranted.

Multi-user telecommunications towers shall be designed to allow for future rearrangement of antennas and to accept antennas mounted at varying heights. Parking areas, access roads, and utility easements shall be shared by site users, at fair market rates as determined by customary industry standards, when in the determination of the Plan Commission this will minimize overall visual impact to the community.

(8) Exempt Facilities

- A. Amateur radio towers installed, erected, maintained and/or operated in any residential zoning district, by a federally-licensed amateur

radio operator, complying with the provisions contained in Chapter 17, MGO, so long as all the following conditions are met:

1. The antenna use involved is accessory to the primary use of the property which is not a telecommunication facility;
 2. In a residential zone, no more than one support structure for licensed amateur radio operator is allowed on the parcel;
 3. Sufficient anti-climbing measures have been incorporated into the facility, as needed, to reduce potential for trespass and injury.
- B. Publicly owned and operated telecommunications facilities required in the public interest to provide for and maintain a radio frequency telecommunication system, including digital, analog, wireless or electromagnetic waves, for police, fire and other municipal services.