

SUBCHAPTER 28K: SUPPLEMENTAL REGULATIONS

28.151 APPLICABILITY

Supplemental regulations are established to address the unique characteristics of certain land uses. The standards and conditions listed for land uses in this chapter are applicable to both permitted uses and uses permitted by conditional use permit, as specified for each zoning district, unless otherwise noted.

28.152 RESIDENTIAL USES – FAMILY LIVING.

- (1) Single-family detached dwelling.

See Subchapter 28L, Building Form Standards.

- (2) Two-flat and three-flat building.

See Subchapter 28L, Building Form Standards.

- (3) Two-family dwelling - Twin.

See Subchapter 28L, Building Form Standards, in addition to the following:

- (a) Each unit shall be separated from the abutting unit by a minimum fire separation complying with ILHR Sec. 21.08, Wis. Admin. Code, providing a vertical separation of all areas from the lowest level to flush against the underside of the roof.
- (b) The common wall between dwellings shall be approximately perpendicular to the street right-of-way line.
- (c) Dwellings shall have separate water services, curb stops, lines and meters. The water service may be split in the terrace, with separate curb stops, lines and meters.
- (d) Dwellings shall have separate sanitary sewer service laterals and lines, subject to including a provision in a joint access and maintenance agreement that addresses emergency access to, and the responsibility for, sanitary sewer building blockage;
- (e) Dwellings shall have separate gas and electric meters.
- (f) Dwellings shall have a joint cross access and maintenance agreement that has been submitted with the land division application and which shall be recorded with the land division.

- (4) Single-family attached building; townhouse, rowhouse.

See Subchapter 28L, Building Form Standards.

- (5) Multi-family building

See Subchapter 28L, Building Form Standards, for “Small Apartment,” “Large Apartment,” and “Courtyard Apartment” buildings.

- (6) Multi-family complex.

See Subchapter 28L, Building form Standards, in addition to the following:

- (a) Recreational areas may be required to serve the needs of the anticipated population.
- (b) Setback requirements may be reduced as part of the conditional use approval, provided that equivalent open space areas are provided.

- (c) Minimum distances between buildings shall equal the combination of the required side yards for each building, unless reduced by the Plan Commission as part of the conditional use approval.
 - (d) An appropriate transition area between the use and adjacent property may be required, using landscaping, screening, and other site improvements consistent with the character of the neighborhood.
- (7) Accessory dwelling unit.
- See Subchapter 28L, Building Form Standards, for “Carriage House Building” in addition to the following:
- (a) Accessory dwelling units within the TR-P District shall meet the following standards:
 - 1. No more than one (1) accessory dwelling unit may be located on a lot.
 - 2. The lot must be a corner lot or abut an alley.
 - 3. The lot must have a minimum area of five thousand (5,000) square feet.
 - 4. The lot must have a minimum width of fifty (50) feet for corner lots and sixty (60) feet for interior lots.
 - 5. An attached accessory dwelling unit shall be part of the single family dwelling on the same lot for the purpose of the bulk requirements of the district. Any secondary dwelling unit connected to the single-family dwelling is considered attached.
 - 6. A detached accessory dwelling unit shall be located only above a detached garage of the single-family dwelling on the same lot.
 - 7. A detached accessory dwelling unit shall be located a minimum of five (5) feet from a side or rear lot line, unless the lot is adjacent to an alley, in which case it shall be located a minimum of two (2) feet from the rear lot line.
 - 8. The height, lot area per dwelling unit, and usable open space requirements for detached accessory dwelling units shall be as specified for the district.
 - 9. The usable open space requirements for a detached accessory dwelling unit shall be fifty percent (50%) of the usable open space requirement in the district.
 - 10. The single-family dwelling on the lot shall be owner-occupied.
 - 11. The entryway to the accessory dwelling unit shall be connected to a street frontage with a paved walkway.
 - 12. The accessory dwelling unit shall have a separate entrance from the single-family dwelling.
 - (b) Accessory dwelling units in other residential districts may be allowed through creation of an ADU Overlay District.
- (8) Caretaker’s dwelling. A caretaker’s dwelling accessory to a nonresidential use shall meet all setback and dimensional standards required for the building type in question (for example, a detached dwelling) in the district where it is located.

28.153 RESIDENTIAL USES – GROUP LIVING.

- (1) Adult family home.

- (a) The loss of any state license or permit by an adult family home shall result in an automatic revocation of that facility's use permit.
 - (b) The applicant must disclose in writing the capacity of the adult family home
 - (c) No new adult family home shall be located within two thousand five hundred (2,500) feet of an adult family home or existing community living arrangement, unless the persons served are disabled or handicapped under the Fair Housing Amendment Act (FHAA) or the Americans with Disabilities Act (ADA) and are living within the adult family home because of their disability or handicap.
 - (d) An adult family home may contain a second kitchen for privacy of staff, but such kitchen facilities shall be dismantled and removed when the arrangement is discontinued.
 - (e) If the adult family home is allowed as a conditional use not meeting the separation requirement under (3) above, the use permit for the adult family home shall not be transferable to another location or permit-holder.
- (2) Cohousing community.
- Cohousing is a permitted use within any housing type that is permitted within the zoning district where the cohousing development is located. Any housing type that is conditional within said zoning district may be used for cohousing with conditional use approval. Any allowed use within the zoning district where the cohousing development is located may be allowed as part of the cohousing development.
- (a) Lot area requirements for individual lots within the cohousing community may be reduced with conditional use approval provided that the overall density remains consistent with minimum lot area standards.
 - (b) Usable open space may be combined and shared among cohousing units.
- (3) Community Living Arrangement (CLA) serving up to eight (8) people.
- (a) The loss of any state license or permit by a CLA shall result in an automatic revocation of that facility's use permit.
 - (b) The applicant must disclose in writing the capacity of the community living arrangement.
 - (c) No new community living arrangement shall be located within two thousand five hundred (2,500) feet of an existing community living arrangement, except as provided under (5) below.
 - (d) The total capacity of all CLAs within an aldermanic district shall not exceed twenty-five (25) persons or one percent (1%) of the population, whichever is greater, of such district, except as provided under (5) below.
 - (e) No separation distance is required and the district percentage specified above does not apply if the persons served are disabled or handicapped under the Fair Housing Amendment Act (FHAA) or the Americans with Disabilities Act (ADA) and are living within the CLA because of their disability or handicap.
- (4) Community living arrangement (CLA) serving nine (9) or more people.
- (a) The loss of any state license or permit by a CLA shall result in an automatic revocation of that facility's use permit.
 - (b) The applicant must disclose in writing the capacity of the community living arrangement.

- (c) No new community living arrangement shall be located within two thousand five hundred (2,500) feet of an existing community living arrangement.
 - (d) The total capacity of all CLAs within an aldermanic district shall not exceed twenty-five (25) persons or one percent (1%) of the population, whichever is greater, of such district.
- (5) Housing cooperative.
- (a) Within the SR-V1, SR-V2, TR-C3 and TR-P districts, upon conditional use approval, a housing cooperative may be established in a dwelling unit, with a maximum occupancy of five (5) persons.
 - (b) Within the TR-V1, TR-V2, TR-U1, TR-U2, NMX, TSS and CC-T districts, a housing cooperative may be established in a dwelling unit as a permitted use if the occupancy is five (5) or fewer persons. Occupancy by more than five (5) persons requires conditional use approval.
 - (c) When housing cooperatives are established within single-family dwellings, the single-family appearance and function of the building shall not be altered through the addition of entrances or kitchens.
 - (d) Two-family, three-family and multi-family buildings may be converted into cooperatives provided that the entire building is converted and must remain as a cooperative while so occupied.
- (6) Dormitory, fraternity or sorority.
- (a) The use must be within one-quarter (1/4) mile of the campus of the institution it serves, unless another location is established in a campus master plan or conditional use approval.
 - (b) The yard requirements for multiple-family use in the district apply when the use is not located on a campus.
 - (c) On-site services shall be for residents of the facility only.
 - (d) Where the use is conditional, all new construction or additions to existing buildings shall be compatible with the scale and character of the surroundings, to the extent practical. An appropriate transition area between the use and adjacent property may be required, using landscaping, screening, and other site improvements consistent with the character of the neighborhood.
 - (e) The owner shall submit a management plan for the facility and a floor plan showing sleeping areas, emergency exits and bathrooms.
- (7) Lodging house.
- (a) The yard requirements for multi-family use in the district apply.
 - (b) Where the use is conditional, all new construction or additions to existing buildings shall be compatible with the scale and character of the surroundings, to the extent practical.
 - (c) The owner shall submit a management plan for the facility and a floor plan showing sleeping areas, emergency exits and bathrooms.
- (8) Assisted living, congregate care, nursing home.
- (a) The yard requirements for multi-family use in the district apply.
 - (b) A facility established after the effective date of this ordinance within a predominantly residential or mixed-use area shall have vehicular access to a collector or higher classification street.

- (c) The site shall contain a minimum of one hundred fifty (150) square feet of usable open space per resident, consisting of outdoor seating areas, gardens and/or recreational facilities. Public parks or plazas within three hundred (300) feet of the site may be used to meet this requirement.
 - (d) Where the use is conditional, an appropriate transition area between the use and adjacent property may be required, using landscaping, screening, and other site improvements consistent with the character of the neighborhood.
 - (e) The owner shall submit a management plan for the facility and a floor plan showing sleeping areas, emergency exits and bathrooms.
- (9) Convent, monastery, similar religious group.
- (a) The use must be accessory to a place of worship that is an allowed use under this ordinance. The use may be located on a separate zoning lot where separated by a public right-of-way from the primary use.
 - (b) The yard requirements for multi-family use in the district apply.
 - (c) A facility established after the effective date of this ordinance within a predominantly residential or mixed-use area shall have vehicular access to a collector or higher classification street.
 - (d) The site shall contain a minimum of one hundred fifty (150) square feet of usable open space per resident, consisting of outdoor seating areas, gardens and/or recreational facilities. Public parks or plazas within three hundred (300) feet of the site may be used to meet this requirement.
 - (e) Where the use is conditional, an appropriate transition area between the use and adjacent property may be required, using landscaping, screening, and other site improvements consistent with the character of the neighborhood.

28.154 CIVIC AND INSTITUTIONAL USES.

- (1) Adaptive reuse of former school or municipal buildings.

Former public school or municipal buildings in residential and special districts may be adapted for the following uses with the approval of the Director of Planning and Community and Economic Development:

- (a) Day care centers
- (b) Elementary and secondary schools
- (c) Arts, technical or trade schools
- (d) Colleges and universities
- (e) Other public educational facilities
- (f) Recreational buildings and community centers, nonprofit
- (g) State or municipal offices
- (h) Offices for health, medical, welfare and other institutions or organizations qualifying as nonprofit under the laws of the State of Wisconsin

Business and professional offices may be allowed in former school or municipal buildings in residential and special districts as a conditional use.

(2) Day care home, family.

- (a) The day care home shall be the principal place of residence of the operator.
- (b) No employees shall be permitted other than residents of the dwelling; however, temporary or substitute caregivers may be present periodically.
- (c) The facility must pass the inspections of the Director of the Neighborhood Preservation and Inspection Division and the Fire Prevention Bureau prior to issuance of a use permit.
- (d) The loss of any state license or permit by a family or group day care home shall result in automatic revocation of that facility's use permit.

(3) Day care center, nursery school.

- (a) The loss of any state license or permit by a day care center shall result in automatic revocation of that facility's use permit.
- (b) A designated area for the short-term parking of vehicles engaged in loading and unloading children shall be provided. The designated area shall be located as close as practical to the principal entrance of the building and shall be connected to the building by a sidewalk.
- (c) Where the use is conditional, an appropriate transition area between the use and adjacent property may be required, using landscaping, screening, and other site improvements consistent with the character of the neighborhood.

(4) Library, museum.

A library or museum established after the effective date of this ordinance within a predominantly residential area shall have vehicular access to a collector or higher classification street.

(5) Mission house in conjunction with religious institution.

- (a) The yard requirements for multi-family use in the district apply.
- (b) A facility established after the effective date of this ordinance within a predominantly residential or mixed-use area shall have vehicular access to a collector or higher classification street.
- (c) Where the use is conditional, an appropriate transition area between the use and adjacent property may be required, using landscaping, screening, and other site improvements consistent with the character of the neighborhood.
- (d) The owner shall submit a management plan for the facility and a floor plan showing sleeping areas, emergency exits and bathrooms.

(6) Place of worship.

- (a) A facility established after the effective date of this ordinance within a predominantly residential or mixed-use area shall have vehicular access to a collector or higher classification street.
- (b) Any facility with seating capacity of greater than 600 persons in the sanctuary or main activity area shall be a conditional use. Such facility shall be located with vehicular access to a collector or higher classification street.
- (c) Where the use is conditional, an appropriate transition area between the use and adjacent property may be required, using landscaping, screening, and other site improvements consistent with the character of the neighborhood.

(7) Schools, public and private, colleges and universities.

- (a) A facility established after the effective date of this ordinance within a predominantly residential or mixed-use area shall have vehicular access to a collector or higher classification street.
 - (b) Where the use is conditional, an appropriate transition area between the use and adjacent property may be required, using landscaping, screening, and other site improvements consistent with the character of the neighborhood.
- (8) School, arts, technical or trade.
- (a) A facility established after the effective date of this ordinance within a predominantly residential or mixed-use area shall have vehicular access to a collector or higher classification street.
 - (b) Where the use is conditional, an appropriate transition area between the use and adjacent property may be required, using landscaping, screening, and other site improvements consistent with the character of the neighborhood.
 - (c) With the exception of facilities located in industrial districts, all activities shall occur within enclosed buildings.
- (9) Correctional facility.
- Within the Conservancy District a correctional facility shall be located at least three hundred (300) feet from any residentially-zoned property.
- (10) Land and water preserves.
- Within the Conservancy District the following activities are permitted:
- (a) Arboretums, environmental education centers
 - (b) Harvesting of wild crops, such as marsh hay, ferns, moss, berries, tree fruits and tree seeds
 - (c) Fishing and trapping
 - (d) Boating and swimming
 - (e) Raising of fish and game animals
 - (f) Similar low-impact educational and recreational activities as determined by the Zoning Administrator
 - (g) Sustained forestry yield

28.155 MIXED COMMERCIAL/RESIDENTIAL USES.

- (1) Home occupation.
- This subsection is established to permit work to be carried on in a residence, by an occupant of that residence, while protecting the integrity and residential character of neighborhoods.
- (a) A home occupation may include small offices, service establishments or homecrafts which are typically considered accessory to a dwelling unit.
 - (b) A home occupation shall not involve on-site wholesaling, manufacturing or assembly, a limousine, towing or cartage business or auto service or repair for any vehicles other than those registered to residents of the property.
 - (c) The occupation must be conducted within a dwelling and not in an accessory building, unless authorized by the plan commission as a conditional use.

- (d) The occupation must be clearly incidental and secondary to the principal use of the dwelling for dwelling purposes.
 - (e) Only members of the immediate family residing on the premises or occupants of the dwelling may be employed, unless authorized by the Plan Commission as a conditional use.
 - (f) No mechanical equipment shall be used except that which is used for purely domestic or household purposes, unless authorized by the plan commission as a conditional use;
 - (g) No products shall be kept or commodities sold, other than those made on the premises, unless authorized by the plan commission as a conditional use;
 - (h) Samples may be kept but not sold on the premises;
 - (i) No more than twenty-five percent (25%) of the floor area of one story of the dwelling may devoted to such home occupation;
 - (j) The entrance to the space devoted to the home occupation must be from within the building.
 - (k) No structural alterations or enlargements shall be made to the dwelling for the primary purpose of conducting the home occupation.
 - (l) The only exterior indication of the home occupation shall be a non-illuminated nameplate a maximum of two (2) square feet in area.
 - (m) Exception: A home occupation of an individual with a disability who is incapable of employment outside the home by reason of significant physical or mental disability, as verified by a signed physician statement verifying the disability, is exempt from the requirements of subparagraphs (g) through (k).
- (2) Live/work unit.
- (a) The work space component must be located on the first floor or basement of the building, with an entrance facing the primary abutting public street.
 - (b) The dwelling unit component must be located above or behind the work space, and maintain a separate entrance located on the front or side facade and accessible from the primary abutting public street.
 - (c) The office or business component of the unit shall not exceed fifty percent (50%) of the total gross floor area of the unit.
 - (d) The size and nature of the work space shall be limited so that the building type may be governed by residential building codes. An increase in size or intensity beyond the specified limit would require the building to be classified as a mixed-use building.
 - (e) The business component of the building may include offices, small service establishments, homecrafts which are typically considered accessory to a dwelling unit, or limited retailing associated with fine arts, crafts, or personal services. The business component shall be limited to those uses otherwise permitted in the district which do not require a separation from residentially zoned or occupied property, or other protected use. It may not include a wholesale business, a manufacturing business, a commercial food service requiring a license, a limousine business or auto service or repair for any vehicles other than those registered to residents of the property.

(3) Mixed use buildings in residential districts.

Mixed use buildings that include residential, commercial and office or studio uses may be allowed as conditional uses at corner locations within certain residential districts, where specified, meeting the following standards:

- (a) Buildings must be located at least one-quarter (1/4) mile from other mixed-use buildings in residential districts.
 - (b) Minimum building height: two (2) stories
 - (c) Maximum height: two (2) stories, may be increased to three (3) stories for underground parking, outstanding design features, or other “green building” features.
 - (d) Buildings must meet NMX district frontage requirements for corner locations and building form standards for commercial block buildings.
 - (e) Building footprint shall not exceed five thousand (5,000) square feet; any retail or office establishment shall not exceed two thousand five hundred (2,500) square feet in floor area.
- (4) Limited retail use of a landmark site or building.
- A designated landmark site or building may be used for general retail, office use, or service business not exceeding five thousand (5,000) square feet in floor area, provided that:
- (a) The owner of the property agrees to maintain the architectural and historical integrity and significance of said landmark or landmark site during the tenure of such conditional use;
 - (b) The use is not considered by the Plan Commission to be detrimental to the neighborhood in which it is situated;
 - (c) The Landmarks Commission has approved such conditional use as being appropriate for the subject structure of site and neighborhood;
 - (d) The owner of the property agrees, on behalf of himself, successors and heirs that if and when the landmark designation is removed the conditional use permit becomes null and void.
- (5) Management office, restaurant, limited retail or recreation facilities within a multi-family building (within residential districts).
- (a) The use is designed to primarily serve building residents rather than the general public.
 - (b) Access to the use is from within the building.
 - (c) Size of the establishment may be limited as part of the conditional use approval.
- (6) Buildings or structures exceeding ten thousand square feet in floor area (residential districts).
- (a) Building floor area, bulk, height and massing may be limited as part of the conditional use approval in order to ensure compatibility with surrounding uses.
 - (b) An appropriate transition area between the use and adjacent property may be required, using landscaping, screening, and other site improvements consistent with the character of the neighborhood.

28.156 MEDICAL FACILITIES.

- (1) Hospital.
- (a) The facility shall have vehicular access to a collector or higher classification street.
 - (b) Where the use is conditional, an appropriate transition area between the use and adjacent property may be required, using landscaping, screening, and other site improvements consistent with the character of the neighborhood.
 - (c) The boundaries of the institution shall be as defined in the conditional use permit or institutional master plan, and may not be expanded without the prior approval of the plan

commission, as evidenced by an amended conditional use permit, or an approved master plan revision. The campus that is defined by the boundaries shall be a minimum of three (3) acres, and all property within the campus boundaries must be contiguous.

(2) Veterinary clinic, animal hospital.

All activity shall take place within completely enclosed buildings with soundproofing and odor control; outdoor kennels are prohibited except in zoning districts where specifically permitted.

28.157 RETAIL SALES AND SERVICE.

(1) General retail.

Within employment districts, general retail uses shall be limited in size to a maximum of ten thousand (10,000) square feet, except where such uses are part of a planned multi-use site.

(2) Animal boarding facility, kennel, animal shelter

(a) Outdoor dog runs or exercise pens shall be located at least two hundred (200) feet from a residential use or district

(b) Any portion of an outdoor kennel facing an adjacent property shall be screened from view by a solid fence, hedge or similar plant material not to exceed six (6) feet in height.

(3) Drive-through facility.

(a) Drive-through lanes and service windows shall be located to the side or rear of buildings, shall not be located between the principal structure and a public street, and shall be at least sixty (60) feet from the closest point of any residentially zoned property or property occupied with a one-, two-, or multiple-family dwelling.

(b) Points of vehicular ingress and egress shall be located at least sixty (60) feet from the intersection of two streets and at least sixty (60) feet from abutting residentially zoned property.

(c) Plans for onsite circulation and driveway locations shall be reviewed as part of the conditional use review process. Site design shall accommodate a logical and safe vehicle and pedestrian circulation pattern. Adequate queuing lane space shall be provided without interfering with onsite parking/circulation.

(d) Speaker box sounds from the drive-through lane shall not be plainly audible so as to unreasonably disturb the peace and quiet of abutting residential property.

(e) Drive-through canopies and other structures, where present, shall be constructed from the same materials as the primary building and with a similar level of architectural quality and detailing.

(f) A six-foot buffer area with screen planting and an obscuring wall or fence shall be required along any property line adjoining an existing residence or residentially zoned property.

(4) Farmers market.

(a) Within the NMX District, a farmer's market with over 15 stalls for vendors is a conditional use.

(b) Within any district, a permanent facility established after the effective date of this ordinance shall have vehicular access to a collector or higher classification street.

(5) Garden center, greenhouse.

- (a) In the NMX, TSS and MXC districts there shall be no exterior storage of bulk materials such as dirt, sand, gravel and building materials.
 - (b) In all other districts bulk materials shall not be stored within the front yard setback and shall meet standards for outdoor storage and display.
- (6) Payday loan business.
Any payday loan or auto title loan business must be located a minimum of five thousand (5,000) feet from any other payday loan or auto title loan business.
- (7) Pet day care.
Applicants must submit at the time of permit application written operating procedures, such as those recommended by the American Boarding and Kennel Association (ABKA) or the American Kennel Club (AKC). Such procedures, which are to be followed for the life of the business, must address the identification and correction of animal behavior that impacts surrounding uses, including excessive barking.
- (8) Service business.
Within the Employment Campus and Industrial districts (IL and IG), service businesses may only be located within a mixed-use building that includes office or other employment uses.

28.158 FOOD AND BEVERAGES.

- (1) All food and beverage uses.
Within the Employment Campus and Industrial districts (IL and IG), these uses shall only be located within a mixed-use building that includes office or other employment uses.
- (2) Brewpub.
Wholesaling of beverages shall be permitted only where “wholesale establishment” is listed as an allowed use within a zoning district.
- (3) Outdoor eating areas accessory to food and beverage uses.
 - (a) Primary access to the area shall be from within the establishment.
 - (b) Hours of operation may be restricted and noise and lighting limits imposed as part of the conditional use permit.
 - (c) Where the use is conditional, an appropriate transition area between the use and adjacent property may be required, using landscaping, screening, and other site improvements consistent with the character of the neighborhood.

28.159 COMMERCIAL RECREATION, ENTERTAINMENT AND LODGING.

- (1) Bed and breakfast establishment.
 - (a) A maximum of four rooms may be rented.
 - (b) The establishment must have a valid permit from the City Health Department.
 - (c) The only meal that may be served is breakfast to registered guests.
 - (d) No establishment within a residential district shall be located within five hundred (500) feet of any other such establishment, measured lot line to lot line.

- (e) Fire protection shall be approved by the Fire Department, and may be more restrictive than State requirements.
 - (f) Length of stay shall not exceed twenty-one (21) consecutive days for each registered guest.
- (2) Indoor recreation.
- In the NMX and TSS districts, the facility shall be located at least fifty (50) feet from the boundary of any residential use or district.
- (3) Lodge or club, private.
- It is permissible to serve food and meals on such premises provided adequate dining room space and kitchen facilities are available. Where properly licensed under existing City ordinances, the consumption of intoxicating beverages by members of such club or lodge, or their guests, is permitted.
- (4) Outdoor recreation, commercial.
- (a) A minimum twenty-five (25) foot setback area maintained as open space shall be provided along the perimeter of the site wherever it abuts a residential property.
 - (b) If the use will be available to the general public, an arterial or collector street of sufficient capacity to accommodate the traffic that the use will generate shall serve the site. Ease of access to the site by automobiles, transit, bicycles, and pedestrians shall be considered as a factor in the review of any development proposal.
 - (c) The site shall be designed in such a way as to minimize the effects of lighting and noise on surrounding properties. Hours of operation may be restricted and noise and lighting limits imposed as part of the conditional use permit.
 - (d) Where the use is conditional, an appropriate transition area between the use and adjacent property may be required, using landscaping, screening, and other site improvements consistent with the character of the neighborhood.
- (5) Golf course.
- Club houses and maintenance buildings shall be located a minimum of three hundred (300) feet from any residentially-zoned property.

28.160 ADULT ENTERTAINMENT USES.

- (1) Adult entertainment establishment. (An adult entertainment establishment is an adult book or video store or an adult motion picture theater.)
- (a) Such establishments shall be licensed as provided in Section 9.05 of these ordinances.
 - (b) Exterior windows shall not be covered or made opaque in any way.
 - (c) No adult entertainment establishment shall be located within one thousand (1,000) feet of any church, synagogue, temple, mosque or any other place of worship, any lot in a residence district, either in the City of Madison or in a municipality adjacent to the City of Madison, any planned developments which allow residential dwelling units; any public park, any private or public elementary, secondary, or vocational school, any public or private playground, any day care center, any public library, any youth recreation area including little league baseball fields, soccer fields, and YMCAs/YWCAs, or any other adult entertainment establishment.

- (d) The distance requirement under subdivision (c) above shall be measured along a straight line from the nearest property line of any church, synagogue, temple, mosque or any other place of worship, any lot in a residence district, either in the City of Madison or in a municipality adjacent to the City of Madison, any planned developments which allow residential dwelling units; any public park, any private or public elementary, secondary, or vocational school, any public or private playground, any day care center, any public library, any youth recreation area including little league baseball fields, soccer fields, and YMCAs/YWCAs, or any other adult entertainment establishment or adult entertainment tavern to the closest property line of the adult entertainment establishment.
 - (e) No material referenced under the definition of Adult Book or Video Store shall be placed in any exterior window, provided that material which is not so referenced may be placed in a window.
 - (f) An adult entertainment establishment may have only one (1) nonflashing business sign, which sign may only indicate the name of the business and identify it as an adult entertainment establishment.
- (2) Adult entertainment venue or tavern.
- (a) No such establishment shall be located within five hundred (500) lineal feet of a church, synagogue, temple, mosque or any other place of worship, any lot in a residence district, either in the City of Madison or in a municipality adjacent to the City of Madison, any planned developments which allow residential dwelling units; any public park, any private or public elementary, secondary, or vocational school, any public or private playground, any day care center, any public library, any youth recreation area including little league baseball fields, soccer fields, and YMCAs/YWCAs, or any tavern, or any other adult entertainment tavern or adult entertainment establishment.
 - (b) The distance requirement under subdivision (a) above shall be measured along a straight line from the nearest property line of any church, private or public day care center, preschool center, or public or private school, or public park, or any library, or any residential district, or any planned developments, or any tavern, or any other adult entertainment tavern or adult entertainment establishment to the closest property line of the adult entertainment tavern.
 - (c) Said tavern shall acquire and maintain an adult entertainment tavern permit pursuant to Section 38.11 of these ordinances prior to issuance of an occupancy permit.

28.161 AUTOMOBILE SERVICES.

- (1) Auto body shop, automobile sales, automobile service station, convenience store.
 - (a) All automobile servicing and repair activities must either:
 - 1. be carried on within an enclosed building; or
 - 2. be screened along any property line that abuts a residential zoning district with:
 - a. a minimum of six-foot high masonry or decorative wood fence; and
 - b. a planted area with a minimum width of eight feet and planted with a minimum of one shade tree per fifty (50) linear feet and one shrub per four (4) linear feet.
 - (b) Automobile repair bays shall not face a local, collector or arterial street, but may face an alley or rear lot line.

- (c) A convenience store shall not be located within three-eighths (3/8) mile (1,980 feet) distance of three (3) or more existing convenience stores, as measured along the center lines of streets.
 - (d) The following activities and equipment are permitted only in the rear yard and at least fifty (50) feet from a residential zoning district:
 - 1. Storage of vehicle parts and refuse;
 - 2. Temporary storage of vehicles while during repair and pending delivery to the customer;
 - 3. Vacuuming and cleaning.
 - (e) The following activities and equipment are permitted only within an enclosed building:
 - 1. Lubrication equipment;
 - 2. Motor vehicle washing equipment;
 - 3. Hydraulic hoists and pits;
 - 4. Body work and painting;
 - 5. Storage of motor vehicles not in safe operating condition.
 - (f) Outside storage or parking of any disabled, wrecked, or partially dismantled vehicle is not permitted for a period exceeding ten (10) days during any thirty (30) day period.
 - (g) No building, structure, canopy, gasoline pump, or storage tank shall be located within twenty-five (25) feet of a residential zoning district.
 - (h) Additional standards and conditions in NMX and TSS Districts: The principal building shall comply with the dimensional and design standards and design guidelines applicable to these districts, except that the maximum setback requirement may be modified by the plan commission so that pump islands may be placed in front of the building if this arrangement is considered preferable for circulation, aesthetics or buffering of neighboring uses.
- (2) Car wash.
- (a) The car wash shall be completely enclosed when not in operation.
 - (b) Any access drive shall be located at least thirty feet from any public street intersection, measured from the interior curb line commencing at the intersection of the street.
 - (c) Any car wash line exit shall be at least thirty feet from any street line.
 - (d) The car wash shall be screened along all property lines with a minimum six-foot high (6') masonry or decorative wood fence. Along any property line that abuts a residential zoning district, an additional planted area shall be provided, with a minimum width of eight feet and planted with a minimum of one shade tree per fifty (50) linear feet and one shrub per four (4) linear feet.
 - (e) Sound from any speakers used on the premises shall not be audible at the boundary of any surrounding residential district or on any residential property.
 - (f) Water from the carwash shall not drain across any sidewalk or into a public right-of-way.
- (3) Motor vehicle salvage yard, scrap yard.

- (a) Vehicle salvage uses shall be located on sites which are suitable from a topographic standpoint, so that views at the ground elevation up to a point four hundred (400) horizontal feet away will be adequately screened with fences and buffer areas surrounding the use.
- (b) All material not stored in a completely enclosed building shall be enclosed with a solid fence which is six (6) to ten (10) feet high and located on or inward from the established setback lines.
- (c) No materials shall be placed on the property that would exceed a height equal to the vertical plane extending from the top of the approved fence.
- (d) Hours of outside activity shall be limited to 7:00 a.m. until 8:00 p.m. and shall follow the City's noise regulations.

28.162 PARKING, STORAGE AND DISPLAY FACILITIES.

(1) Parking.

See standards and requirements in Section 28.141.

(2) Outdoor display.

Where permitted, outdoor sales and display areas shall be separated from any adjacent street, sidewalk, or public walkway by development frontage landscaping, as specified in Section 28.142(6).

(3) Outdoor storage.

Where permitted, outdoor storage shall be located outside of the front yard setback and shall not be placed between the principal building and the abutting street. Outdoor storage shall be completely screened from any adjacent street, sidewalk, public walkway, public park, or residential property with screening as specified in Section 28.142(10)B.

28.163 LIMITED PRODUCTION, PROCESSING AND STORAGE USES.

(1) Contractor's yard.

In the TW district, outdoor storage shall be located to the rear of the principal building. In all districts, outdoor storage shall be screened as provided in Section 28.142(10)B.

(2) Laboratories - research, development and testing.

No manufacturing shall be conducted on the premises except for experimental or testing purposes.

(3) Limited production and processing.

In mixed-use, commercial and employment districts, all such uses are intended to be compatible with adjacent nonindustrial uses. Odors, noise, vibration, glare and other potential side effects of manufacturing processes shall not be discernable beyond the property line.

(4) Storage facility, personal indoor storage.

- (a) No commercial transactions shall be permitted other than the rental of storage units.
- (b) Plans for onsite circulation and driveway locations shall be reviewed as part of the conditional use review process. Site design shall accommodate a logical and safe vehicle and pedestrian circulation pattern.

28.164 AGRICULTURAL AND RESOURCE MANAGEMENT USES.

(1) Intensive agriculture.

To calculate number of animal units, use the most current Animal Units Calculation Worksheet of the Department of Natural Resources. This worksheet is used to determine whether an operation will reach or exceed 1,000 animal units, in which case a WPDES permit is required under NR 243, Wis. Admin. Code.

(2) Community garden or market garden.

The following activities as part of a community or market garden operation require submittal of a management plan to the zoning administrator. The plan shall be reviewed as part of the site plan review process.

- (a) Animal husbandry, (includes keeping of more than four (4) chickens, beekeeping and fish farming);
- (b) Off-street parking of more than ten (10) vehicles;
- (c) Processing of food produced on site;
- (d) Spreading of manure;
- (e) Application of agricultural chemicals, including fertilizers and pesticides;
- (f) Use of heavy equipment such as tractors.

(3) Roadside stand, farm stand.

- (a) The stand may not be permanently affixed to the ground and must be readily removable in its entirety.
- (b) Maximum area of a roadside stand is three hundred (300) square feet in ground area.
- (c) No more than one (1) roadside stand is allowed on any one premise.

(4) Selective cutting.

On parcels approved for development, selective cutting is limited to areas designated for clearance on recorded plats or certified survey maps. Destruction of trees in excess of this amount is considered clear-cutting.

(5) Clear cutting.

The applicant must demonstrate that clear cutting will improve the level of environmental protection on the subject property or is unavoidable due to grading or other development requirements. Areas clearcut beyond thirty percent (30%) of vegetation shall be replanted; replanting may occur in other portions of the property.

28.165 PUBLIC UTILITY AND PUBLIC SERVICE USES.

(1) Sewage system lift station, water pumping stations, towers and reservoirs.

The location of the facility must be reviewed and a landscape plan for the facility must be approved by the Director of Planning and Community and Economic Development.

(2) Telecommunication facilities.

See Section 28.143, General Regulations.

28.166 ACCESSORY STRUCTURES AND USES.

- (1) Emergency electrical generator.
 - (a) The electric output shall not exceed three thousand (3,000) kilowatts and the generator may be operated a maximum of two hundred (200) hours per year.
 - (b) The generator shall be located a minimum of twenty (20) feet from any zoning lot which permits residential uses
 - (c) The generator shall be located and screened so as to reduce its visual impact when viewed from neighboring property and to be compatible with neighboring structures and the character of the community. This may include screening with materials similar in appearance to those used for the principal structure on the zoning lot, landscaping or fencing as approved by the Plan Commission.
 - (d) Noise mitigation measures may be required.
- (2) Rental of off-street parking facilities which are accessory to a nonresidential use to persons not using the principal use:
 - (a) The parking facilities must meet the standards of this Chapter 28 and Chapter 10 of the Madison General Ordinances.
 - (b) A certificate of occupancy must be issued by the office of the Director of the Building Inspection Division prior to commencing the rental.

28.167 TEMPORARY STRUCTURES AND USES.

- (1) Dependency living arrangement.
 - (a) The owner of the dwelling must continue to reside in the building. The use permit issued under this paragraph is not transferable to another owner or occupant.
 - (b) The exterior appearance of the building shall remain generally the same. Any new entrance shall be placed on the side or rear facade of the building. Additions shall not increase square footage by more than ten percent (10%).
 - (c) Upon termination of the specific occupancy, all second kitchen facilities installed for this use shall be dismantled and removed from the premises within six (6) months unless an extension is granted because of potential re-occupancy.
- (2) Accessory apartment, temporary.

One temporary accessory apartment may be created within an owner-occupied dwelling under the following standards.

 - (a) The owner of the dwelling must continue to reside there. The use permit issued under this paragraph is not transferable to another owner or occupant.
 - (b) One of the owners must be sixty (60) years of age or older, or that the Madison Health Director must certify to the Zoning Administrator that the owner's health is such that conversion is permitted in accordance with standards recommended by the Public Health commission and Senior Citizens Advisory Committee and approved by the Common Council.
 - (c) The exterior appearance of the building shall remain generally the same. Any new entrance shall be placed on the side or rear facade of the building. Additions shall not increase square footage by more than ten percent (10%).

- (d) Upon termination of the specific occupancy, all second kitchen facilities installed for this use shall be dismantled and removed from the premises within six (6) months unless an extension is granted because of potential re-occupancy.

(3) Keeping of chickens.

Keeping of chickens is allowed as an accessory use on lots with up to four (4) dwelling units.

- (a) Keeping of roosters is prohibited.
- (b) Slaughter of chickens is prohibited on site.
- (c) The chickens shall be provided with a covered enclosure and must be kept in the covered enclosure or a fenced enclosure at all times.
- (d) The enclosure shall be located at least twenty-five (25) feet from any residential structure on an adjacent lot.
- (e) The owner, operator or tenant must obtain a license under Sec. 9.52, MGO.

(4) Outdoor sales events.

A maximum of four (4) outdoor sales events may be held annually, for a total maximum of thirty (30) days per calendar year.

(5) Portable storage units.

- (a) A maximum of two (2) Portable Storage Units, not exceeding a cumulative gross floor area of two hundred fifty (250) square feet shall be permitted on a lot for no more than thirty (30) days per calendar year.
- (b) The Portable Storage Unit(s) may be placed on a driveway, but may not be placed on that portion of the driveway located in the front yard or side yard setbacks.
- (c) A temporary use permit is required.

(6) Temporary buildings for storage of construction materials and equipment.

Buildings must be located on the same zoning lot as the project under construction, and shall be removed within thirty (30) days following completion of construction.

(7) Yard sales.

A yard sale shall not exceed four (4) days in duration, and no more than one sale shall be held in any three (3) month period.

SUBCHAPTER 28L: BUILDING FORM STANDARDS

28.171 GENERAL PROVISIONS.

(1) Statement of Purpose.

A variety of building forms are defined here in order to identify and establish basic design parameters for those buildings that may be appropriate in one or more zoning districts. The purposes of design standards are:

- (a) To ensure compatibility between different land uses and building forms;
- (b) To encourage building forms that respect their context;
- (c) To encourage pedestrian movement by encouraging building forms that present an active face to the street.

(2) Applicability.

The design standards in this Subchapter shall apply to new buildings or building additions that exceed the gross floor area occupied by a given use by more than fifty percent (50%), with the exceptions listed below. Building additions shall comply with the design standards to the extent feasible, given the placement of the existing building. In all cases, design standards shall apply only to the portion of the building or site that is undergoing alteration

Some design standards are closely linked to a specific building form (for example, a parking building). Other design standards vary by district, and are listed in those district subchapters.

Building types that are not listed in this Subchapter may be allowed if they meet the intent and other design standards of the district where they would be located.

(3) Exceptions and Waivers.

The design standards in this Section shall not apply within those zoning districts where buildings are specifically exempted from these design standards. Where there is a conflict between the design standards in this Section and the standards within a particular district, the district standards shall take precedence.

A waiver or modification of any standard may be requested as part of site plan review if the applicant can demonstrate that there are circumstances unique to the property that make compliance impractical or unreasonable. Waivers may be granted by the Zoning Administrator following review by the Urban Design Commission. The applicant may appeal the Zoning Administrator's decision to the Zoning Board of Appeals.

28.172 RESIDENTIAL BUILDING FORMS.

(1) Use of Dormers.

Dormers may be added to the roof of a two-story building, provided that the dormer width does not exceed fifty percent (50%) of the lineal width of the floor immediately below the roof.

(2) **Single-Family Detached Building.**

- (a) **Building Type.** A single-family dwelling with yards on all sides, oriented to the street, with an attached or detached garage.
- (b) **Access and Entry.** Each dwelling shall have direct access from a porch, stoop or courtyard to the street. Parking, loading and trash disposal may be accessed from an alley or driveway.
- (c) **Parking.** Surface parking may be located in the side or rear yard setbacks or within the building envelope, as specified in Section 28.141.
- (d) **Attached Garages.** See Section 28.031(3), Attached Garage Setback.
- (e) **Frontage.** Each building must include a stoop, porch or courtyard oriented towards the primary abutting street.
- (f) **Building Width.** Buildings facing a public street shall not exceed a width of fifty (50) feet along a single plane on the axis facing the street. Additional building wings facing the street shall be set back at least five (5) feet behind the front plane of the building.

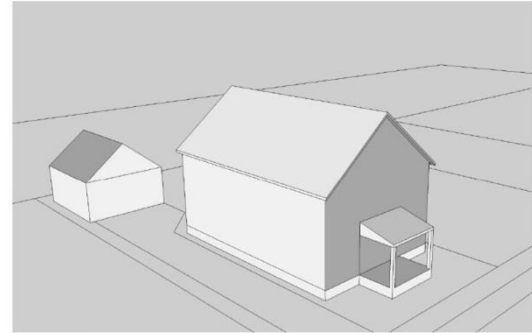

Typical Single Family Detached Building

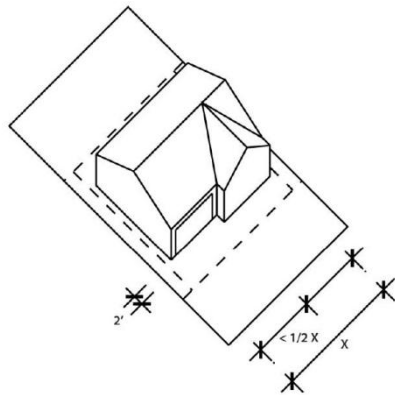

Attached Garage Setback

(3) Two-Flat and Three-Flat Buildings.

(a) Building Types.

1. **Two-Flat.** A building containing two dwelling units that are vertically stacked one above the other, with a separate entrance to each unit and with yards on all sides.
2. **Three-Flat:** A building containing three dwelling units that are vertically stacked one above the other, with a separate entrance to each unit and with yards on all sides.

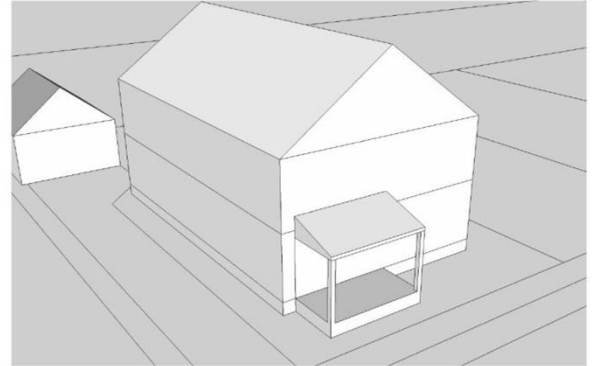

Typical Two-Flat Building

- (b) Access and Entry. At least one of the dwellings shall have direct access from a common porch or stoop facing the front lot line and street. Parking, loading and trash disposal may be accessed from an alley or driveway.
- (c) Parking. Surface parking may be located in the side or rear yard setbacks or within the building envelope (see Section 28.141).
- (d) Attached Garages. See Section 28.031(3), Attached Garage Setback.
- (e) Frontage. Each building must include a stoop, porch or terrace serving at least one of the dwelling units, oriented toward the primary street.
- (f) Building Width. Buildings facing a public street shall not exceed a width of forty (40) feet along a single plane on the axis facing the street. Additional building wings facing the street shall be set back at least five (5) feet behind the front plane of the building.

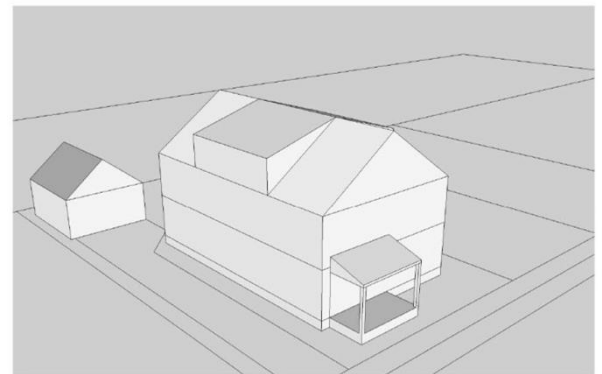

Typical Three-Flat Building

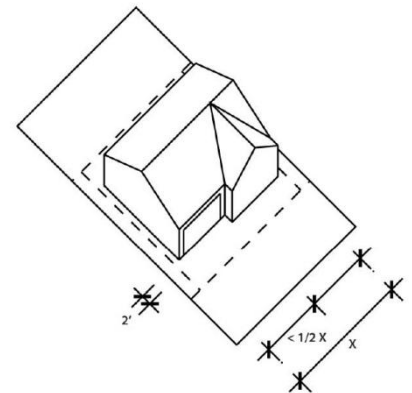

Attached Garage Setback

(4) Two-Family Building, Twin.

(a) Building Type. A building containing two attached dwelling units that share a common side wall and that are usually on separate lots, with the common wall at the lot line. If the dwellings are on separate lots, the common wall must be located on the side lot line. The dwellings can also be treated as condominiums, with a third ownership area consisting of the remainder of the lots.

(b) Access and Entry. Each dwelling shall have direct access from a common or separate porch or stoop; at least one entrance shall face the front lot line.

Parking, loading and trash disposal may be accessed from an alley or driveway. Both units may, (and are encouraged to) share a common driveway.

(c) Parking. Surface parking may be located in the side or rear yard setbacks or within the building envelope. (see Section 28.141).

(d) Attached Garages. See Section 28.031(1), Attached Garage Setback.

(e) Frontage. Each building must include a stoop, porch or terrace serving at least one of the dwelling units, oriented toward the primary street.

(f) Building Width. Buildings facing a public street may not be wider than fifty (50) feet along a single plane on the axis facing the street. Additional building wings facing the street shall be set back at least five (5) feet behind the front plane of the building.

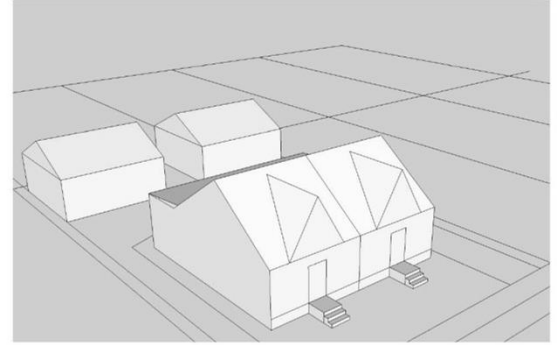

Typical Two-Family Twin Building

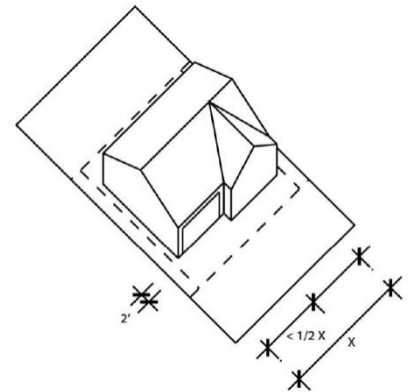

Attached Garage Setback

(5) Single-Family Attached Building, Townhouse, Rowhouse.

(a) Building Type. A dwelling unit within a linear group of horizontally attached dwellings, each having a private entrance and totally exposed front and rear walls to be used for access, light and ventilation. Buildings may be oriented to the street or to a central green or courtyard.

(b) Access and Entry. The principal entry to

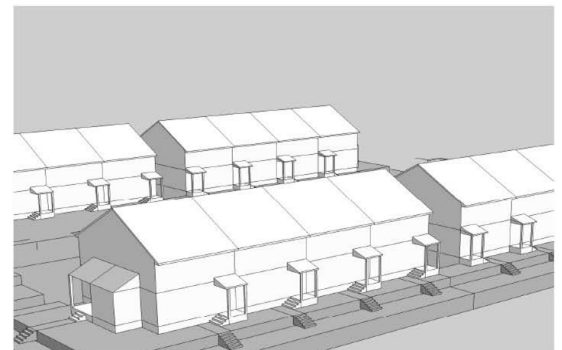

Typical Single Family Attached Buildings

each dwelling shall have direct access to the street or to a courtyard.

Parking, loading and trash disposal may be accessed from an alley or common side yard driveway serving one or more buildings.

- (c) Parking. Parking shall be located behind each building or in a common parking court in the interior of a block. Parking may be in a variety of configurations: surface, “tuck-under,” underground, or within an attached or detached garage to the rear of the principal building. Surface or structured parking may be located within the side yard provided that it occupies no more than twenty-five (25%) of the frontage along the primary abutting street.
- (d) Frontage. Each dwelling must include a stoop or porch or a common green or courtyard oriented toward the primary street.
- (e) Massing and Articulation. Buildings facing a public street shall be comprised of individual units, articulated vertically to create visual interest and continuity. Divisions or breaks in materials, entry placement, window bays or other architectural details shall be used to delineate individual units.

Massing, proportions and articulation of single-family attached buildings should respond to existing residential buildings in their vicinity. Maximum building length parallel to the primary abutting street shall not exceed one hundred sixty (160) feet without a significant articulation of the facade.

- (f) Landscaping. Front yards shall be landscaped to provide visual screening and privacy. Landscaping may consist of trees, shrubs, and/or groundcovers, in combination with decorative fences or walls.



(6) **Small Apartment Building.**

(a) **Building Type.** A multi-story multi-family building with a central entrance oriented to the primary abutting street, containing four to eight units. Buildings of this type are sometimes designed to resemble a large single-family building with a pitched roof.

(b) **Access and Entry.** The principal entry to the building shall be oriented to the primary abutting street.

Parking, loading and trash disposal may be accessed from an alley or common sideyard driveway serving one or more buildings.

(c) **Parking.** Parking shall be located behind each building, below the building, or in a common parking court in the interior of a block. Surface or structured parking may be located within the side yard provided that it occupies no more than twenty-five percent (25%) of the frontage along the primary abutting street.

(d) **Frontage.** Each building must include a stoop or porch or a common green or courtyard, oriented toward the primary street.

(e) **Massing and Articulation.** Massing, proportions and articulation of small apartment buildings should respond to existing residential buildings in their vicinity, including features of those buildings such as roof pitch, proportions of windows and doors, and placement on the lot. Building facades shall be articulated vertically and horizontally for visual interest.

(f) **Landscaping.** Front yards shall be landscaped to provide visual screening and privacy. Landscaping may consist of trees, shrubs, and/or groundcovers, in combination with decorative fences or walls.

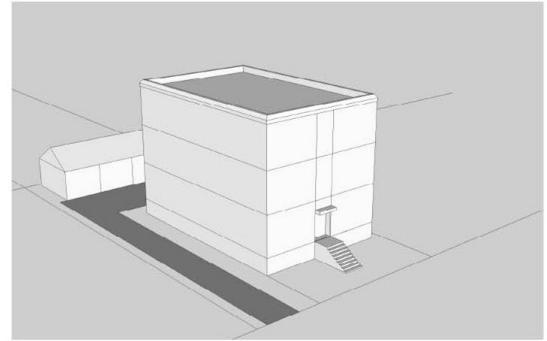

Typical Small Apartment Building



(7) Large Apartment Building, Stacked Flats.

- (a) Building Type. A multi-story building with combined entrances, stairways and elevators, comprised of single- or two-level occupant spaces stacked on top of each other, typically accessed from a central corridor.
- (b) Access and Entry. The principal entry to the building shall be oriented to the primary abutting street. Parking, loading and trash disposal may be accessed from an alley or common drive serving one or more buildings.
- (c) Parking. Parking shall be located behind each building, under the building, or in a common parking court in the interior of a block. Parking may be located within the side yard provided that it occupies no more than twenty-five percent (25%) of the frontage along the primary abutting street. Structured parking at ground floor level shall not be visible from the front façade of the building.
- (d) Frontage. Each building must include a stoop or porch oriented to the street.
- (e) Massing and Articulation. Massing, proportions and articulation of single-family attached buildings should respond to existing residential buildings in their vicinity. Maximum building length parallel to the primary abutting street shall not exceed one hundred sixty (160) feet without a significant articulation of the facade. Facades facing a public street shall be vertically articulated at a minimum interval of forty (40) feet.
- (f) Landscaping. Front yards shall be landscaped to provide visual screening and privacy. Landscaping may consist of trees, shrubs, and/or groundcovers, in combination with decorative fences or walls.

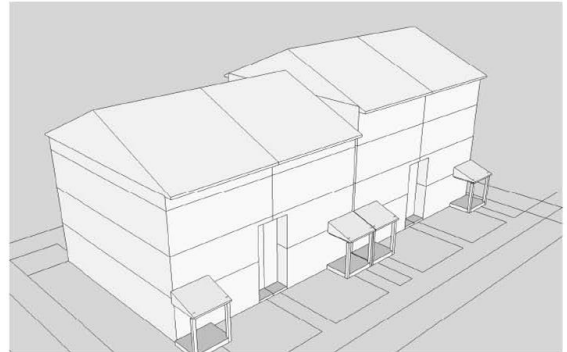

Typical Large Apartment Building



(8) **Courtyard Apartment Building.**

- (a) **Building Type.** A multi-story multi-family building designed around an open courtyard abutting a primary street, surrounded by building walls on three sides.
- (b) **Access and Entry.** The principal entry to the building shall be oriented to the primary abutting street or courtyard. The courtyard shall be oriented to a street and shall be largely visible from the street, but may be separated from the street by a decorative fence.

Parking, loading and trash disposal may be accessed from an alley, through the courtyard, or through a common drive serving one or more buildings.

- (c) **Parking.** Parking shall be located behind each building or wholly or partially underground. Structured parking visible at ground floor level shall not be visible from the front façade of the building. Surface parking may be located to the side yard of a courtyard building provided that it occupies no more than twenty-five percent (25%) of the frontage along the primary abutting street.
- (d) **Massing and Articulation.** Buildings may be divided into individual attached units at ground level or served by shared entrances. Maximum building length parallel to the primary abutting street shall not exceed one hundred sixty (160) feet without a significant articulation of the facade. Facades facing a public street shall be vertically articulated at a minimum interval of forty (40) feet.
- (e) **Landscaping and Open Space.** Courtyards shall be a minimum of thirty-five (35) feet in width or depth, and shall be maintained as common open space for residents. Courtyards shall be fully landscaped and may also include play structures and other amenities.

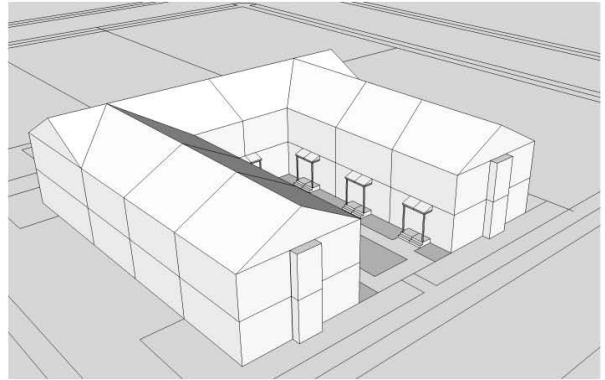

Typical Courtyard Apartment Building



(9) Carriage House Building.

- (a) Building Type. A building containing a detached garage and an accessory dwelling unit of modest size located above the garage. It is located on an alley or on the rear one-third of a lot that includes a principal building.
- (b) Access and Entry. The principal entry to the unit shall be accessed from the side or rear yard or alley. The entry shall be connected to the abutting street by a paved walkway.
- (c) Parking. Parking shall be located below or beside the unit and accessed from an alley or side yard driveway.
- (d) Building Design. Carriage houses shall employ materials, roof pitch, orientation, door and window placement and proportions, and other details compatible with those of the principal building.

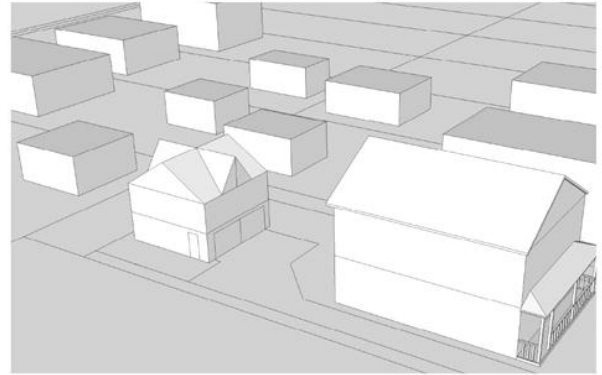

Typical Carriage House Building



28.173 MIXED USE AND NON-RESIDENTIAL BUILDING FORMS.

(1) Commercial Block Building.

- (a) Building Type. A multi-story building that is designed to support a mix of commercial or office uses on the ground floor with office, studio, lodging and/or residential units above. Buildings are typically designed with storefronts or arcades at ground floor.
- (b) Access and Entry. Principal entry to each ground floor unit shall be a direct entrance from the primary abutting street. Parking, loading and trash disposal may be accessed from an alley or through a sideyard or rearyard drive serving one or more buildings.
- (c) Parking. Parking shall be not be located between the building's front façade and the street. Parking may be located behind the rear plane of the principal building on the lot, or within a side yard, provided that no more than seventy (70) feet of lot

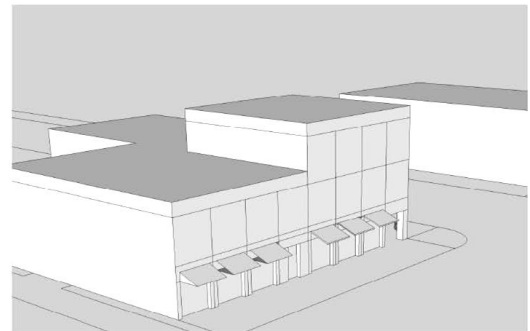

Typical Commercial Block Building

frontage along the primary abutting street is occupied by parking or driveways. Parking may also be wholly or partially underground, or in a common parking area in the interior of a block.

- (d) **Frontage.** Buildings shall be designed with storefronts, stoops or patios along at least forty percent (40%) of the front ground floor façade along the primary abutting street.
- (e) **Massing and Articulation.** Maximum building length parallel to the primary abutting street shall not exceed one hundred sixty (160) feet without a significant articulation of the facade. Facades facing a public street shall be vertically articulated at a minimum interval of forty (40) feet. Entrances shall be provided at least every forty (40) feet along the primary abutting street.



(2) **Liner Building.**

- (a) **Building Type.** A specialized building, parallel to the street, which is designed to conceal an area such as a parking lot or loading dock. While liner buildings may include commercial or residential uses, their limited depth (from front to back) makes them more disposed to residential use. Liner buildings may have a small common front yard, but do not include individual private outdoor spaces.
- (b) **Access and Entry.** The principal entry to each ground floor unit shall be a direct entrance from the primary abutting street.
- (c) **Massing and Articulation.** Maximum building length parallel to the primary abutting street shall not exceed three hundred (300) feet without a visual break such as a courtyard or recess. Minimum building depth is sixteen (16) feet. Facades facing a public street shall be vertically articulated at a minimum interval of forty (40) feet. Entrances shall be provided at least every forty (40) feet along the primary abutting street.

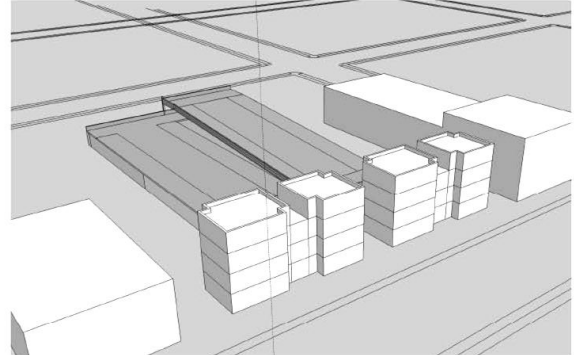

Typical Liner Building



(3) **Parking Building.**

- (a) **Building Type.** A multi-story building specifically designed for parking of automobiles on a temporary basis, which may also include ground-floor storefronts and upper-level office space. Often paired with a liner building along the street frontage.
- (b) **Access and Entry.** Principal entry to each ground floor business or unit shall be a direct entrance from the primary abutting street. Vehicular entrance drives shall be located and designed to minimize interference with pedestrian movement. Vehicular entrances on secondary streets are encouraged.
- (c) **Building Design.** The ground floor of any parking structure abutting a public street or walkway shall be designed and architecturally detailed in a manner consistent with new commercial or mixed-use buildings.

Upper floors shall be designed so that sloped floors typical of parking structures do not dominate the appearance of the façade.

Windows or openings shall be provided that echo those of surrounding buildings.

- (d) **Massing and Articulation.** Maximum building length parallel to the primary abutting street shall not exceed (300) feet without a visual break such as a courtyard or recess. Facades facing a public street shall be vertically articulated at a minimum interval of forty (40) feet. Entrances shall be provided at least every forty (40) feet along the primary abutting street.

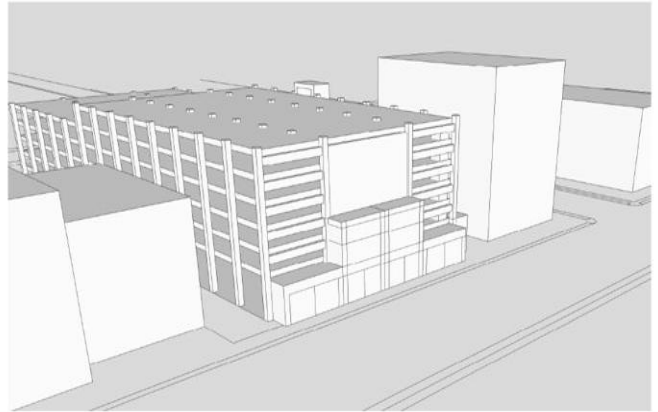

Typical Parking Building



(4) Live-Work Building.

- (a) Building Type. Similar to townhouses in scale and detailing, but with a ground floor designed for small commercial, office and service establishments, often with storefront detailing. Buildings are typically placed close to the sidewalk, although a forecourt or patio design may be used to allow for outdoor seating space.
- (b) Access and Entry. Principal entry to each ground floor unit shall be a direct entrance from the primary abutting street.
- (c) Parking. Parking shall be located behind each building or wholly or partially underground. Parking may be located within the side yard provided that it occupies no more than 25% of the lot frontage along the primary abutting street.
- (d) Massing and Articulation. Massing, proportions and articulation of live-work buildings should respond to existing residential buildings in their vicinity. Maximum building length along the primary abutting public street shall not exceed one hundred sixty (160) feet without a significant articulation of the facade. Facades facing a public street shall be vertically articulated at a minimum interval of forty (40) feet.

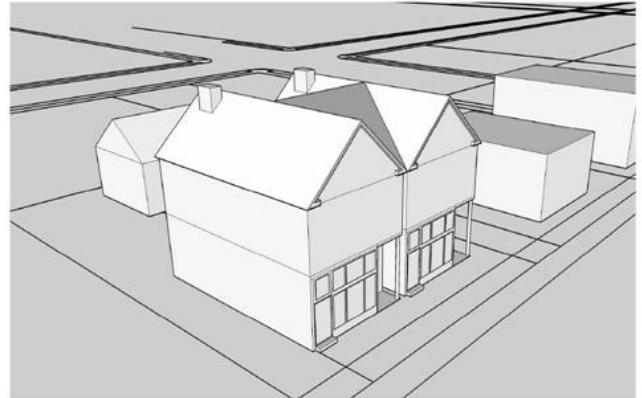

Typical Live-Work Building



(5) Residential/Commercial Conversion.

- (a) Building Type. A former single-family dwelling converted to commercial or office use. The front yard generally remains as landscaped open space or courtyard; parking must be in the rear. The building form remains residential in character; ground floor windows and doors may be enlarged for improved visibility and access.
- (b) Access and Entry. Principal entry to each ground floor unit shall be a direct entrance from the primary abutting street.
- (c) Parking. Parking shall be located behind the building or in a separate common off-street parking facility. Side yard parking may be acceptable if no other alternatives exist.
- (d) Frontage and Design. The residential form of the building shall generally be maintained. Porch, stoop or patio frontage may be acceptable. Accessibility may be improved through changes in entrance grade or other means.

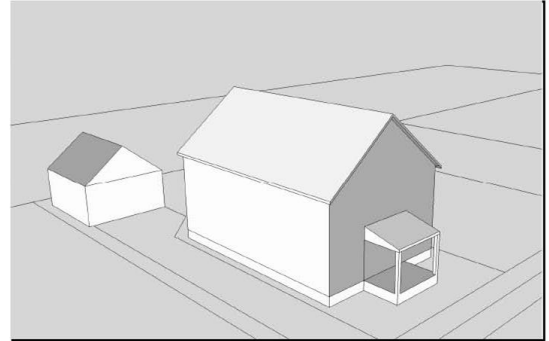

Typical Residential / Commercial Conversion



(6) Podium Building.

- (a) Building Type. A multi-story mixed-use building in which the upper stories are stepped back from a lower base, to provide outdoor terraces, to avoid excessive shadowing of streets or public spaces, or to preserve important views.
- (b) Access and Entry. One or more ground floor entrances from the primary abutting street shall be provided.
- (c) Parking. Parking shall be located behind each building, under the building, or in a common parking court in the interior of a block. Parking may be also be located within a side yard provided that it occupies no more than forty percent (40%) of the frontage along the primary abutting street. Structured parking at ground floor level shall not be visible from the front façade of the building.
- (d) Massing and Articulation. Maximum building length along the primary abutting public street shall not exceed one hundred sixty (160) feet without a significant articulation of the facade. Facades facing a public street shall be vertically articulated at a minimum interval of forty (40) feet.

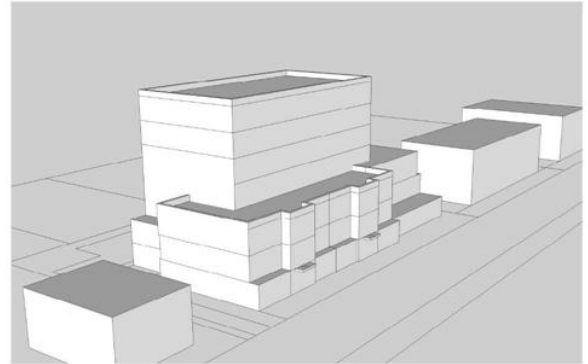

Typical Podium Building



(7) Flex Building.

- (a) Building Type. A variable building type at least two stories in height, designed to accommodate a variety of uses, including combinations of office, retail, lodging, and/or residential. A principal entrance should be oriented to the primary abutting street.
- (b) Access and Entry. One or more ground floor entrances from the primary abutting street shall be provided.
- (c) Parking. Parking shall not be located between the building's front façade and the street. Parking may be located behind the rear plane of the principal building on the lot, or within a side yard, provided that no more than seventy (70) feet of lot frontage along the primary abutting street is occupied by parking or driveways.

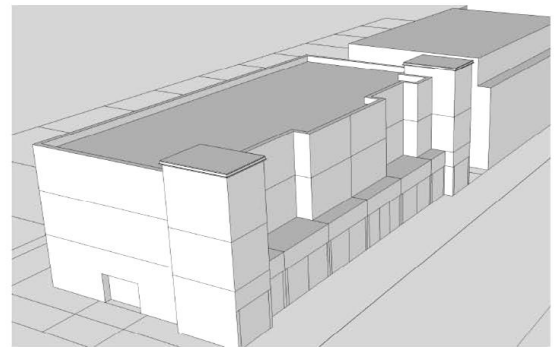

Typical Flex building

Parking may also be wholly or partially underground, or in a common parking area in the interior of a block.

- (d) Massing and Articulation. Maximum building length along the primary abutting public street shall not exceed one hundred sixty (160) feet without a significant articulation of the facade. Facades facing a public street shall be vertically articulated at a minimum interval of forty (40) feet



(8) Industrial Building.

- (a) Building Type. A large open-floor-plate building that allows maximum flexibility in the types of uses accommodated. Buildings are typically characterized by a tall single story or first floor, and may be set on a raised base to facilitate industrial loading and unloading.
- (b) Access and Entry. One or more ground floor entrances from the primary abutting street shall be provided.
- (c) Parking. Parking may be provided on any side of the building. Loading activities shall be situated to the side or rear of the building.
- (d) Massing and Articulation. Facades facing a public street shall be vertically articulated at a minimum interval of 60 feet.

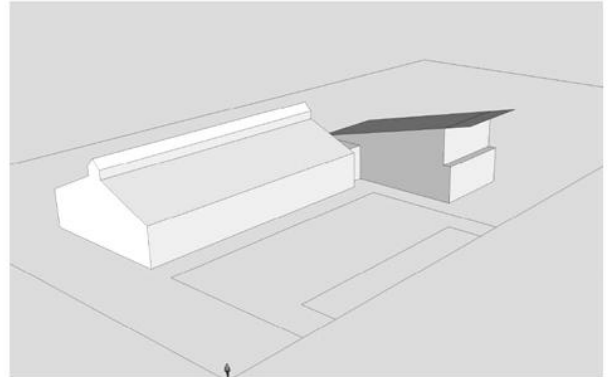

PAGE LEFT BLANK INTENTIONALLY