

# Windows & Lead Paint

---

Landmarks Commission

November 11, 2019



# Windows Components

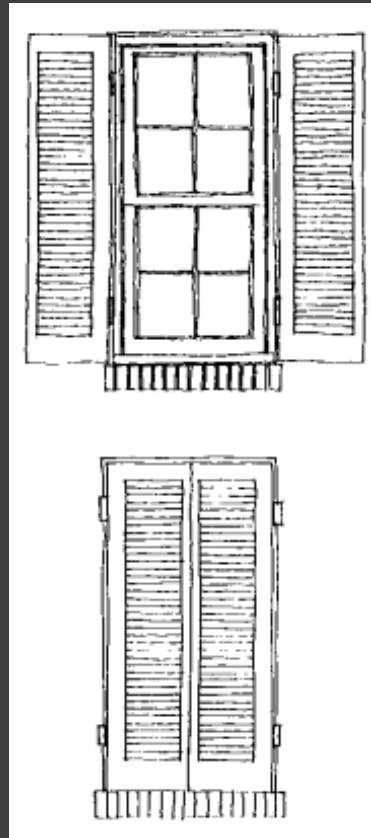
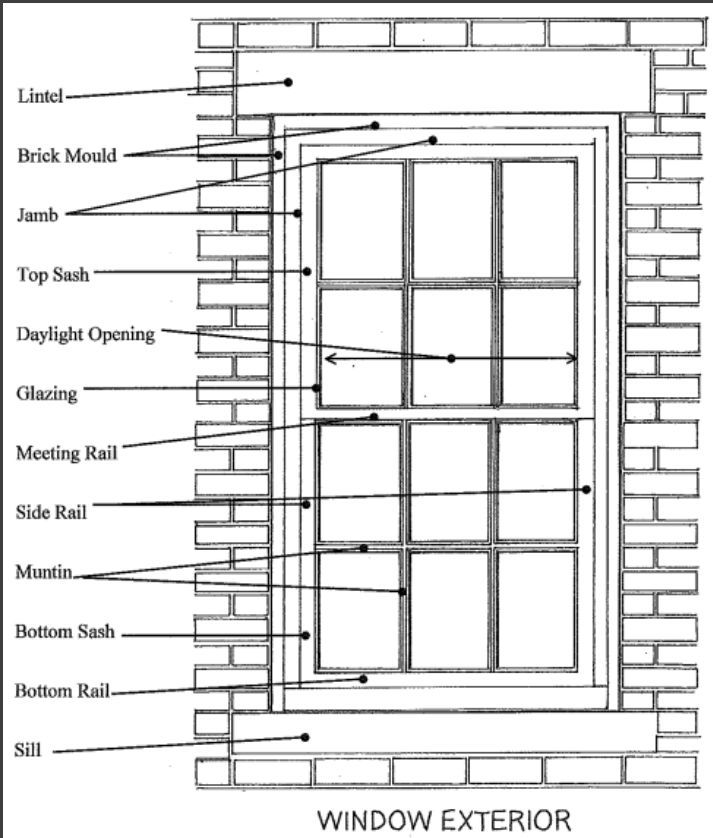

## Typical Window Hoods



Cast iron hood molding

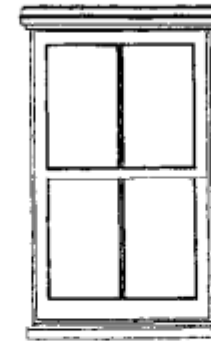

Wood hood molding and sill

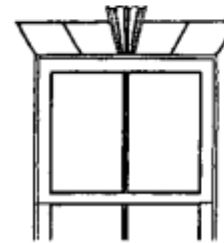

Stone jack arch

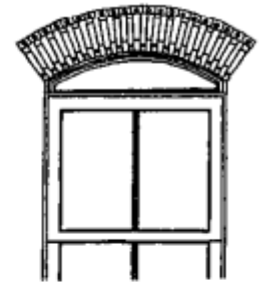

Masonry pellet molding



Tin or zinc pedimented hood

# Window Types

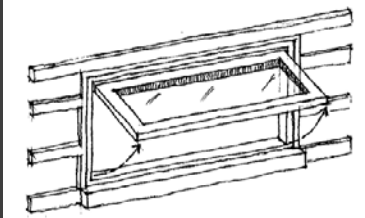

Awning Window

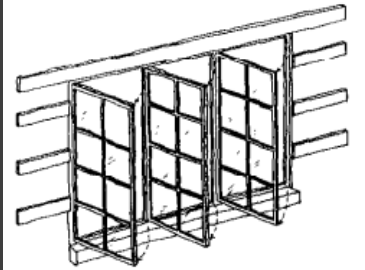

Casement Window

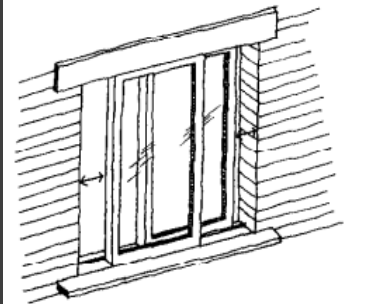

Sliding Window

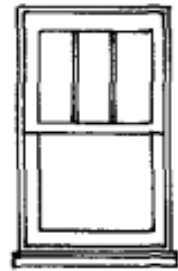

Three-over-one

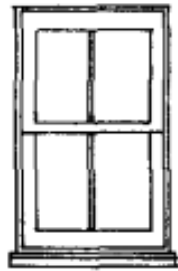

Two-over-two

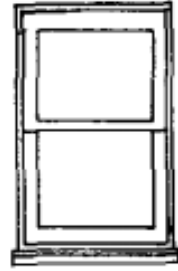

One-over-one

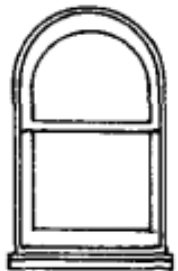

One-over-one with half-round arch

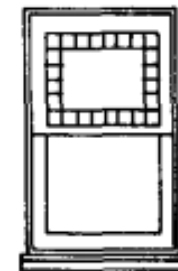

One-over-one with art glass

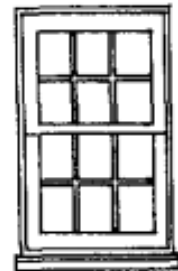

Six-over-six

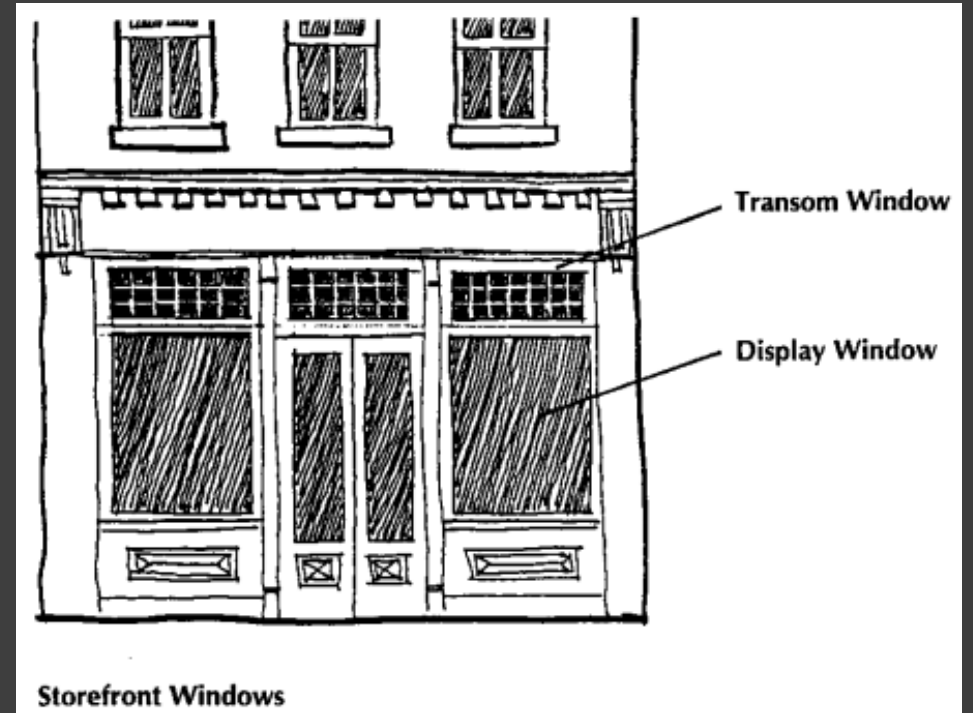

Storefront Windows







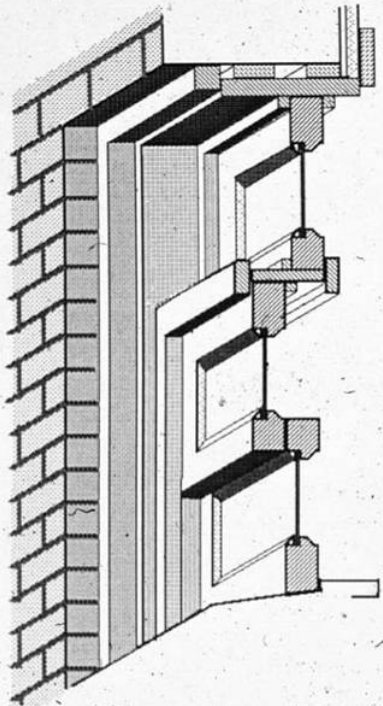

**TYPICAL WOOD WINDOW CONSTRUCTION**

Note the heavy modeling created by the thicknesses of the wooden members and the distance that the glass is set back from the front of the window sash.

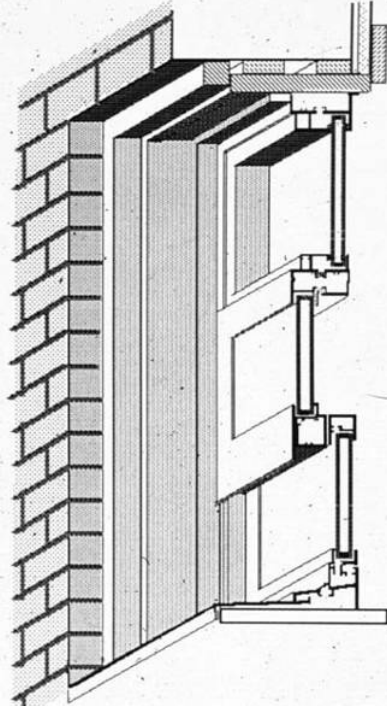

**UNACCEPTABLE ALUMINUM REPLACEMENT WINDOWS**

Even though this window's proportions approximate those of the wooden window, the framing members have almost no depth and there is almost no setback between the glass and the sash.

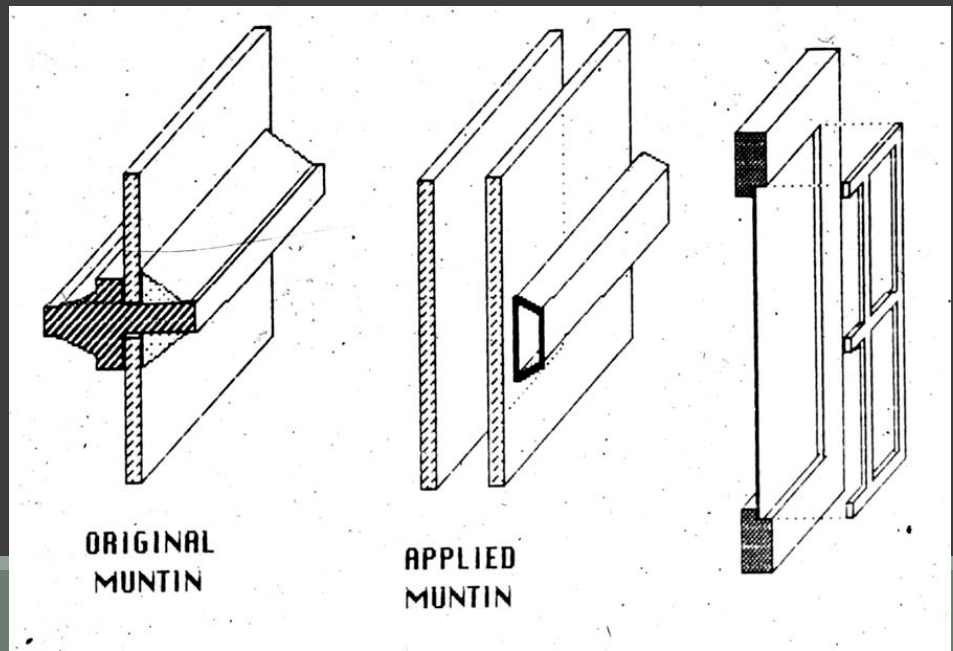
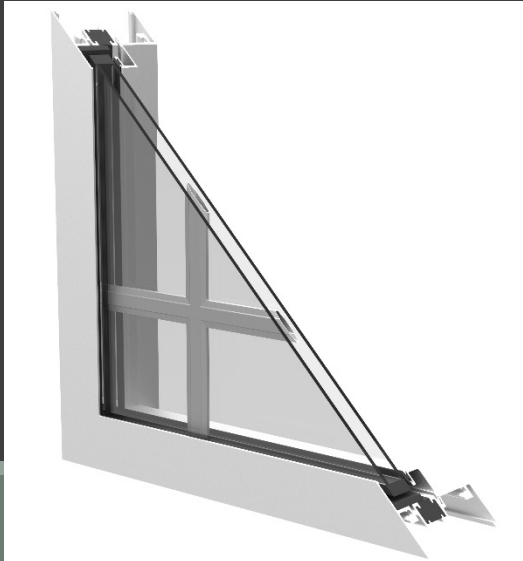
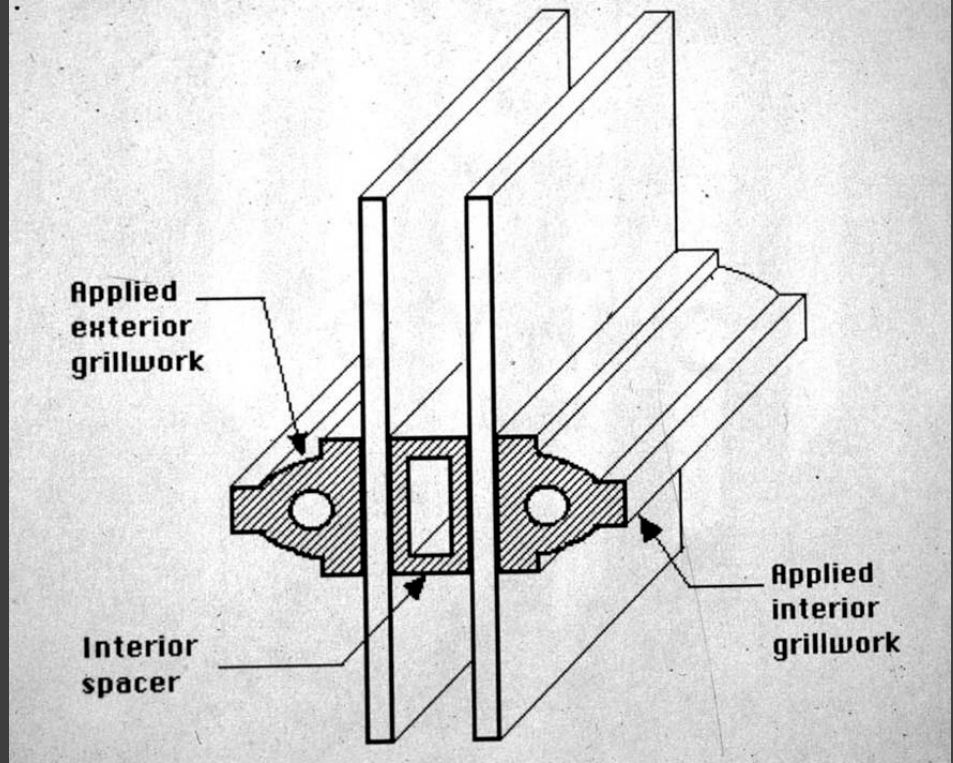

# Lead Paint Issues

---

*HUD Guidelines for the Evaluation and Control of Lead-Based Paint Hazards in a House, “Chapter 18: Lead-Based Paint and Historic Preservation,” 2012.*

## **V. Establishing Priorities for Intervention**

In the absence of a lead-based paint evaluation, priorities for intervention should focus on areas where lead hazards may exist, such as areas of deteriorated paint and abrading friction surfaces of windows, doors and stairs. **The mere presence of lead paint on a building component does not constitute a hazard.**

- Paint removal is 2<sup>nd</sup> least invasive method
- Install jamb liners in friction surfaces
- Optional to pan window wells for ease of cleaning





# Lead Paint Safety

A Field Guide for Interim Controls in Painting and Home Maintenance

U.S. Department of Housing and Urban Development  
Office of Lead Hazard Control and Healthy Homes

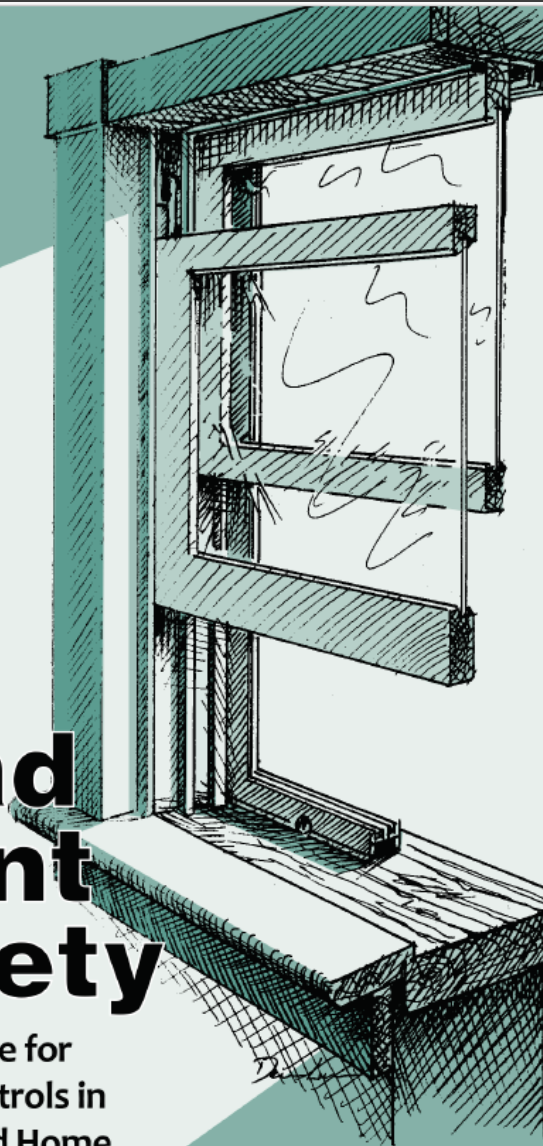

Percentage of Homes Likely to Contain Lead



## PAINT REMOVAL

**PROBLEM:** Areas of paint are peeling or flaking or there is evidence that a child has been chewing on a painted surface. An example of a surface accessible to children is the inside nose of a window stool (inside sill).

**SOLUTION:** Remove all paint using methods that do minimum harm to the surface, create minimal dust, and are safe for workers.





Falk, et al, *Remilling of Salvaged Wood Siding Coated with Lead-based Paint*, Forest Products Society, 2005.

Stan Lebow, Research Forest Products Technologist, USFS Forest Products Laboratory

Table 4. — Penetration of lead in wood siding from Fort Ord buildings.

Sample no.	Total lead before planing <sup>a</sup>	Depth of cut <sup>b</sup>	Total lead after planing
	(mg/kg)	(mm)	(mg/kg)
1	5300	1.02	8.4
2	6500	1.27	6.9
3	1700	1.78	48.0
4	7500	1.27	65.0
5	5400	2.54	26.0
6	6500	2.03	2.4
Avg.	5480	1.65	26.1

<sup>a</sup>Indicates unplanned sample.

<sup>b</sup>Amount of material removed with planer from top painted surface of siding.





# Sustainability

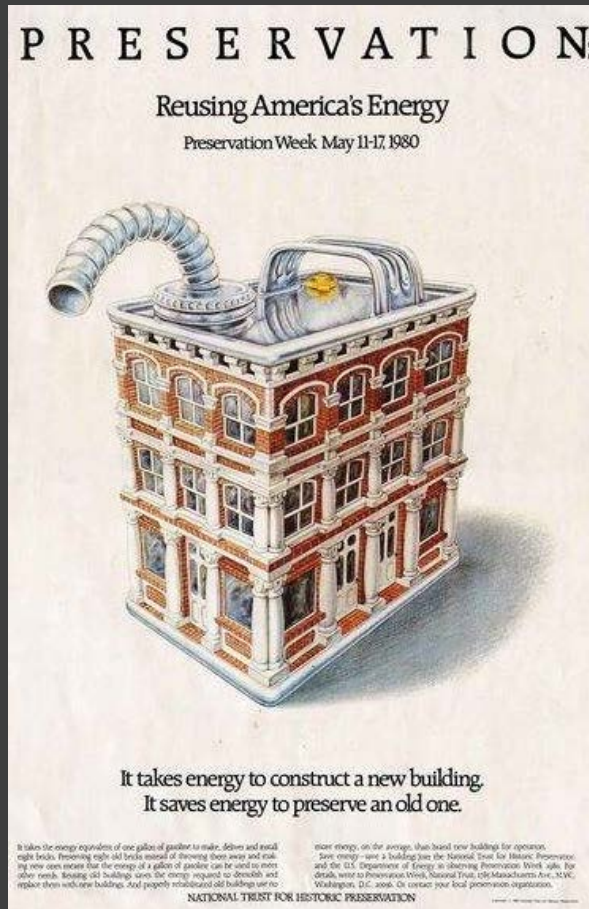

Certainly, a window that is original to a structure constructed during the period of significance is the type of “feature” of a “historic resource” that the Historic Preservation Ordinance is designed to protect. Thus, if someone proposes the removal of an original window from a historic resource, then I think the ordinance creates a strong presumption that Landmarks Commission should determine that the removal of that window would frustrate the public interest in protecting historic resources, and deny the Certificate of Appropriateness pursuant to sub. (d).

Windows Memo, 2017.



## LIFE CYCLE COST COMPARISON

This Queen Anne style house was built in 1894. When it was remodeled in 2008, its beautifully detailed, rot-resistant hardwood windows had been in place for 114 years. They were removed and replaced.

Despite the homeowner's expectations of energy savings, they've now entered a costly cycle of regular window replacement every 15-20 years. While the typical cost of a replacement window ranges from \$300-\$700, high quality windows can easily cost from \$1,000 to \$4,000 per window. Although new high-performance windows provide an average of 17% to 29% energy savings, it is doubtful that those savings will cover the cost of the windows before the windows must be replaced again. Only if this house has no more than 30 windows, each costing \$700, lasting 20 years and resulting in an energy savings of 25%, and if their energy bills were at least \$4,000 per year (\$335 or more per month) would there be a chance that the energy savings would justify the cost of window replacement before needing to be replaced again.

On the other hand, if the building owner had restored the historic windows (\$280-\$700 per window) and added storm windows (\$165-\$295), they would have achieved similar energy savings (14% to 24%), escaped the replacement cycle by having windows that can last another 50-100 years without significant work needed, and in so doing reduced their total cost and overall environmental impact.

### Sources:

[home.costhelper.com/window-replacement.html](http://home.costhelper.com/window-replacement.html)

[www.homeadvisor.com/cost/doors-and-windows/repair-windows/](http://www.homeadvisor.com/cost/doors-and-windows/repair-windows/)

[www.homeadvisor.com/cost/doors-and-windows/install-replace-storm-windows](http://www.homeadvisor.com/cost/doors-and-windows/install-replace-storm-windows)

[www.improvenet.com/r/costs-and-prices/storm-windows](http://www.improvenet.com/r/costs-and-prices/storm-windows)



Preservation Pennsylvania, *Considering the Repair, Retrofit, and Replacement of Historic Windows*, 2016.



## Annual Percent Energy Savings For Various Window Upgrade Options

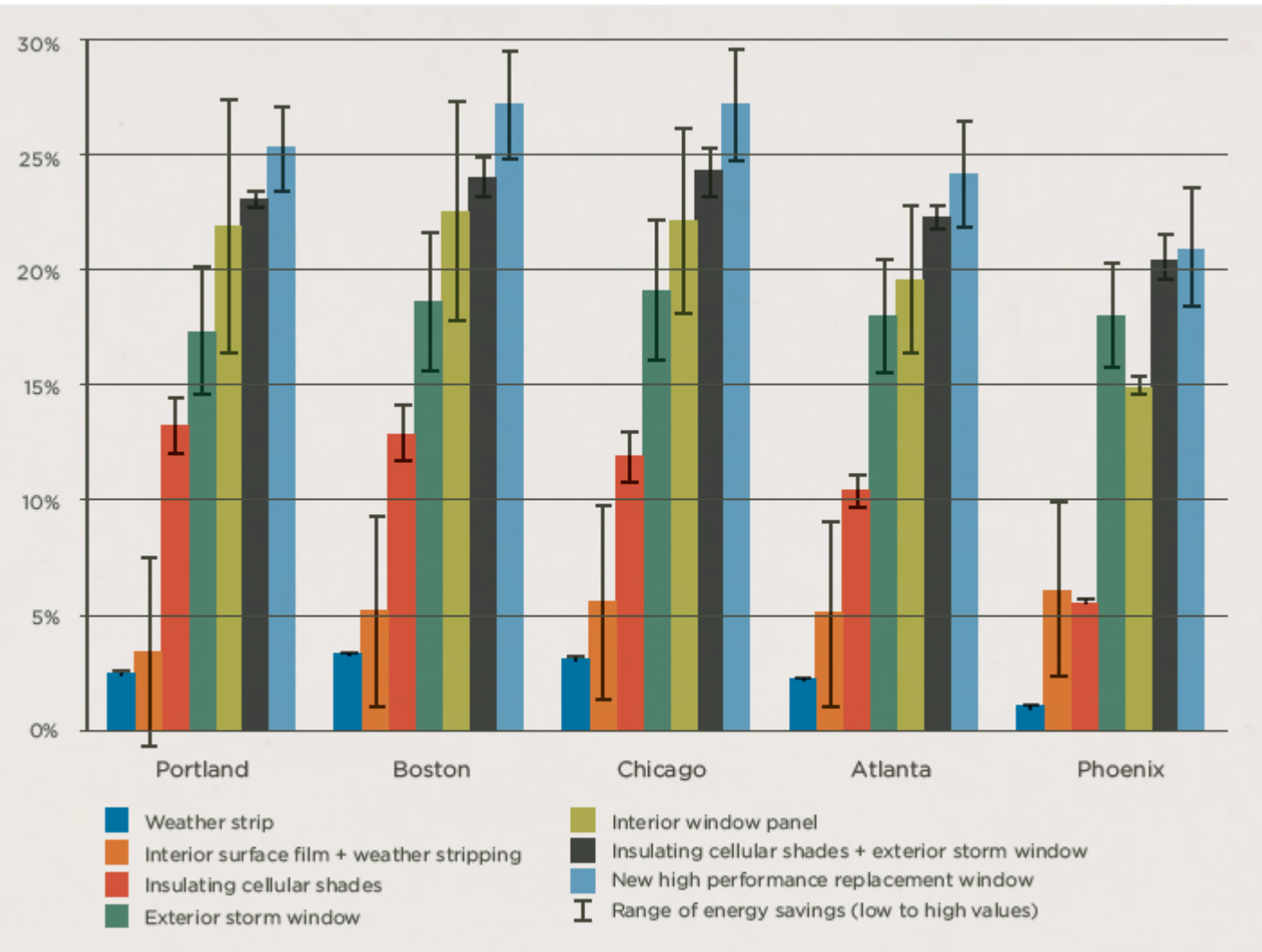

Note: Percentage savings are not intended to predict actual savings. Instead, the results are meant to be used to evaluate the relative performance of measures where other more cost-effective energy saving strategies have been implemented first.

Preservation Green Lab, *Saving Windows, Saving Money: Achieving Home Energy Efficiency Through Low-Cost Retrofit*, 2016.





*The report's key findings include:*

## RETROFITTING SAVES MONEY.

Almost every retrofit strategy, from weather stripping and sealing, to installing exterior storm windows or interior cellular shades, offers a better return on investment than outright window replacement. Simple rates of return for window retrofit measures ranged from 3 percent to 4 percent for most regions studied, nearly double that of new, energy efficient windows.

## RETROFITTING SAVES ENERGY.

Several retrofit measures perform as well as new replacement windows. Specifically, interior window panels and the combination of exterior storm windows and cellular blinds essentially match the energy savings of new, efficient replacement windows.

(See energy savings comparison chart on Page 3.)

## CLIMATE DOESN'T (REALLY) CHANGE THE FINDINGS.

In both hot and cold climate regions, cost analysis revealed that retrofitting generally provided a higher return on investment than replacement windows—though climate did impact which retrofitting option(s) performed the best.

## THE BOTTOM LINE: DON'T ASSUME YOU NEED NEW WINDOWS.

For years it has been commonly assumed that replacement windows alone provide the greatest energy-saving benefit. This study's results refute that notion, giving budget-conscious consumers viable alternatives that cost much less than window replacement. The findings are especially important in the context of historic homes, where retrofitting windows can help maintain the visual appeal and historic integrity.



Interior storm panel.

Image courtesy of: Environmental Window Solutions, LLC

Preservation Green Lab, *Saving Windows, Saving Money: Achieving Home Energy Efficiency Through Low-Cost Retrofit*, 2016.