

URBAN DESIGN COMMISSION APPLICATION

UDC

City of Madison
Planning Division
Madison Municipal Building, Suite 017
215 Martin Luther King, Jr. Blvd.
P.O. Box 2985
Madison, WI 53701-2985
(608) 266-4635



FOR OFFICE USE ONLY:

Paid _____ Receipt # _____
Date received 10/20/2020
4:41 p.m.
Received by _____
Aldermanic District _____
Zoning District _____
Urban Design District _____
Submittal reviewed by _____
Legistar # _____

RECEIVED

Complete all sections of this application, including the desired meeting date and the action requested.

If you need an interpreter, translator, materials in alternate formats or other accommodations to access these forms, please call the phone number above immediately.

1. Project Information

Address: _____

Title: _____

2. Application Type (check all that apply) and Requested Date

UDC meeting date requested _____

New development

Alteration to an existing or previously-approved development

Informational

Initial approval

Final approval

3. Project Type

Project in an Urban Design District

Project in the Downtown Core District (DC), Urban Mixed-Use District (UMX), or Mixed-Use Center District (MXC)

Project in the Suburban Employment Center District (SEC), Campus Institutional District (CI), or Employment Campus District (EC)

Planned Development (PD)

General Development Plan (GDP)

Specific Implementation Plan (SIP)

Planned Multi-Use Site or Residential Building Complex

Signage

Comprehensive Design Review (CDR)

Signage Variance (i.e. modification of signage height, area, and setback)

Signage Exception

Other

Please specify _____

4. Applicant, Agent, and Property Owner Information

Applicant name _____ Company _____

Street address _____ City/State/Zip _____

Telephone _____ Email _____

Project contact person _____ Company _____

Street address _____ City/State/Zip _____

Telephone _____ Email _____

Property owner (if not applicant) _____

Street address _____ City/State/Zip _____

Telephone _____ Email _____

5. Required Submittal Materials

- Application Form
- Letter of Intent
 - If the project is within an Urban Design District, a summary of how the development proposal addresses the district criteria is required
 - For signage applications, a summary of how the proposed signage is consistent with the applicable CDR or Signage Variance review criteria is required.
- Development Plans (Refer to checklist on Page 4 for plan details)
- Filing fee
- Electronic Submittal*
- Notification to the District Alder
 - Please provide an email to the District Alder notifying them that you are filing this UDC application. Please send this as early in the process as possible and provide a copy of that email with the submitted application.

Each submittal must include fourteen (14) 11" x 17" collated paper copies. Landscape and Lighting plans (if required) must be full-sized and legible. Please refrain from using plastic covers or spiral binding.

Both the paper copies and electronic copies must be submitted prior to the application deadline before an application will be scheduled for a UDC meeting. Late materials will not be accepted. A completed application form is required for each UDC appearance.

For projects also requiring Plan Commission approval, applicants must also have submitted an accepted application for Plan Commission consideration prior to obtaining any formal action (initial or final approval) from the UDC. All plans must be legible when reduced.

**Electronic copies of all items submitted in hard copy are required. Individual PDF files of each item submitted should be compiled on a CD or flash drive, or submitted via email to udcapplications@cityofmadison.com. The email must include the project address, project name, and applicant name. Electronic submittals via file hosting services (such as Dropbox.com) are not allowed. Applicants who are unable to provide the materials electronically should contact the Planning Division at (608) 266-4635 for assistance.*

6. Applicant Declarations

1. Prior to submitting this application, the applicant is required to discuss the proposed project with Urban Design Commission staff. This application was discussed with Plan Commission Advisory Referral on October 5, 2020.
2. The applicant attests that all required materials are included in this submittal and understands that if any required information is not provided by the application deadline, the application will not be placed on an Urban Design Commission agenda for consideration.

Name of applicant Rod Ripley Relationship to property Owner
 Authorizing signature of property owner  Date 10/15/20

7. Application Filing Fees

Fees are required to be paid with the first application for either initial or final approval of a project, unless the project is part of the combined application process involving the Urban Design Commission in conjunction with Plan Commission and/or Common Council consideration. Make checks payable to City Treasurer. Credit cards may be used for application fees of less than \$1,000.

Please consult the schedule below for the appropriate fee for your request:

- Urban Design Districts: \$350 (per §35.24(6) MGO).
- Minor Alteration in the Downtown Core District (DC) or Urban Mixed-Use District (UMX) : \$150 (per §33.24(6)(b) MGO)
- Comprehensive Design Review: \$500 (per §31.041(3)(d)(1)(a) MGO)
- Minor Alteration to a Comprehensive Sign Plan: \$100 (per §31.041(3)(d)(1)(c) MGO)
- All other sign requests to the Urban Design Commission, including, but not limited to: appeals from the decisions of the Zoning Administrator, requests for signage variances (i.e. modifications of signage height, area, and setback), and additional sign code approvals: \$300 (per §31.041(3)(d)(2) MGO)

A filing fee is not required for the following project applications if part of the combined application process involving both Urban Design Commission and Plan Commission:

- Project in the Downtown Core District (DC), Urban Mixed-Use District (UMX), or Mixed-Use Center District (MXC)
- Project in the Suburban Employment Center District (SEC), Campus Institutional District (CI), or Employment Campus District (EC)
- Planned Development (PD): General Development Plan (GDP) and/or Specific Implementation Plan (SIP)
- Planned Multi-Use Site or Residential Building Complex

Introduction

The City of Madison's Urban Design Commission (UDC) has been created to:

- Encourage and promote high quality in the design of new buildings, developments, remodeling, and additions so as to maintain and improve the established standards of property values within the City.
- Foster civic pride in the beauty and nobler assets of the City, and in all other ways possible assure a functionally efficient and visually attractive City in the future.

Types of Approvals

There are three types of requests considered by the UDC:

- Informational Presentation. Applicants may, at their discretion, request to make an Informational Presentation to the UDC prior to seeking any approvals to obtain early feedback and direction before undertaking detailed design. Applicants should provide details on the context of the site, design concept, site and building plans, and other relevant information to help the UDC understand the proposal and provide feedback. (Does not apply to CDR's or Signage Variance requests)
- Initial Approval. Applicants may, at their discretion, request initial approval of a proposal by presenting preliminary design information. As part of their review, the Commission will provide feedback on the design information that should be addressed at Final Approval stage.
- Final Approval. Applicants may request Final Approval of a proposal by presenting all final project details. Recommendations or concerns expressed by the UDC in the initial approval must be addressed at this time.

Presentations to the Commission

Primarily, the UDC is interested in the appearance and design quality of projects. Emphasis should be given to the site plan, landscape plan, lighting plan, building elevations, exterior building materials, color scheme, and graphics.

When presenting projects to the UDC, applicants must fill out a registration slip provided in the meeting room and present it to the Secretary. Presentations should generally be limited to 5 minutes or as extended by motion by consent of the Commission. The Commission will withhold questions until the end of the presentation.

Applicants are encouraged to consider the use of various graphic presentation material including a locator map, photographs, renderings/model, scale drawings of the proposal in context with adjacent buildings/uses/signs, etc., as may be deemed appropriate to describe the project and its surroundings. Graphics should be mounted on rigid boards so that they may be easily displayed. **Applicants/presenters are responsible for all presentation materials, AV equipment and easels.**

URBAN DESIGN DEVELOPMENT PLANS CHECKLIST

The items listed below are minimal application requirements for the type of approval indicated. Please note that the UDC and/or staff may require additional information in order to have a complete understanding of the project.

1. Informational Presentation

- Locator Map
- Letter of Intent (If the project is within an Urban Design District, a summary of how the development proposal addresses the district criteria is required)
- Contextual site information, including photographs and layout of adjacent buildings/structures
- Site Plan
- Two-dimensional (2D) images of proposed buildings or structures.

Providing additional information beyond these minimums may generate a greater level of feedback from the Commission.

Requirements for All Plan Sheets

1. Title block
2. Sheet number
3. North arrow
4. Scale, both written and graphic
5. Date
6. Fully dimensioned plans, scaled at 1"= 40' or larger

*** All plans must be legible, including the full-sized landscape and lighting plans (if required)*

2. Initial Approval

- Locator Map
- Letter of Intent (If the project is within a Urban Design District, a summary of how the development proposal addresses the district criteria is required)
- Contextual site information, including photographs and layout of adjacent buildings/structures
- Site Plan showing location of existing and proposed buildings, walks, drives, bike lanes, bike parking, and existing trees over 18" diameter
- Landscape Plan and Plant List (*must be legible*)
- Building Elevations in both black & white and color for all building sides (include material callouts)
- PD text and Letter of Intent (if applicable)

Providing additional information beyond these minimums may generate a greater level of feedback from the Commission.

3. Final Approval

All the requirements of the Initial Approval (see above), **plus:**

- Grading Plan
- Proposed Signage (if applicable)
- Lighting Plan, including fixture cut sheets and photometrics plan (*must be legible*)
- Utility/HVAC equipment location and screening details (with a rooftop plan if roof-mounted)
- PD text and Letter of Intent (if applicable)
- Samples of the exterior building materials (presented at the UDC meeting)

4. Comprehensive Design Review (CDR) and Variance Requests (*Signage applications only*)

- Locator Map
- Letter of Intent (a summary of how the proposed signage is consistent with the CDR or Signage Variance criteria is required)
- Contextual site information, including photographs of existing signage both on site and within proximity to the project site
- Site Plan showing the location of existing signage and proposed signage, dimensioned signage setbacks, sidewalks, driveways, and right-of-ways
- Proposed signage graphics (fully dimensioned, scaled drawings, including materials and colors, and night view)
- Perspective renderings (emphasis on pedestrian/automobile scale viewsheds)
- Illustration of the proposed signage that meets Ch. 31, MGO compared to what is being requested.
- Graphic of the proposed signage as it relates to what the Ch. 31, MGO would permit

July 29, 2020



Heather Stouder
Department of Planning & Community & Economic Development
Madison Municipal Building, Suite 017
215 Martin Luther King Jr. Blvd
P.O. Box 2985
Madison, Wisconsin 53701-2985

Re: Letter of Intent
Lucky's 1313 Expansion
1313 Regent Street
Madison, WI

Ms. Heather Stouder,

The following is submitted together with the plans and application for staff review and sign-off.

Organizational Structure:

Owner/Developer: FCS Plan B, LLC
WI 1579 County Road V #1
Lodi, WI 53555
Phone: 608-279-4163
Contact: Rod Ripley
rodripley@gmail.com

Engineer: D'Onofrio Kottke & Associates
7530 Westward Way
Madison, WI 53717
Phone: 608-833-7530
Contact: Ron Klaas
rklaas@donofrio.cc

Architect: Knothe & Bruce Architects, LLC
7601 University Avenue, Ste. 201
Middleton, WI 53562
Phone: 608-836-3690
Contact: Kevin Burow
kburow@knothebruce.com

Landscape Design: D'Onofrio Kottke & Associates
7530 Westward Way
Madison, WI 53717
Phone: 608-833-7530
Contact: Matt Saltzberry
msaltzberry@donofrio.cc

Introduction:

The proposed project is the expansion of Lucky's 1313 located at 1313 Regent Street and is the culmination of the recent renovation of this property. When the building was converted from a Auto Repair Garage in 2016 it was intended to have a vertical expansion to add housing above the new Brew Pub and Restaurant. Footings were selectively placed within the existing building accordingly in order to accommodate this. The property is zoned TSS - Transitional Shopping Street District and will stay the same.

This proposal will add housing units above and behind the existing building while not increasing the size of the existing Brew Pub. The southern portion of this site is currently used as a parking lot and outdoor volleyball courts. These will be reconfigured to accommodate a basement level of parking and the addition of townhome-style units along Bowen Court.

Project Description:

The expansion consists of adding three floors of apartments over the existing building and then bridging across the reconfigured parking lot to connect to additional units being added along Bowen Court. There will be a total of 63 apartment units plus a community space with access to a rooftop patio on the southern side of the property. The building will be a total of four stories along Regent Street and three stories along Bowen Court. The building will include 37 underground parking stalls and 23 surface stalls.

This site is within easy walking distance to the UW Campus and is located directly on a Madison Metro Bus route and is adjacent to other Student Rental Housing.

The building architecture references both the residential and commercial characteristics of the area. The exterior materials will be a combination of masonry to match Lucky's and both horizontal and panel composite siding. The townhome units located along Bowen Court will have direct entry to the units from the exterior and will fit in well with the residential character of that side of the property.

Conditional Use approvals:

The proposed redevelopment requires conditional uses to allow for more than 8 residential units within a mixed-use building, for a building that is 4 stories in height, and also for a building larger than 25,000 sq.ft.. The proposed building's size, scale and use are consistent with the City's Comprehensive Plan for this property, which calls for Neighborhood Mixed Use in 2-4 stories along Regent Street and Low-Medium Residential in 1-3 stories along Bowen Court.

City and Neighborhood Input:

We have met with the City on several occasions for this proposed development including meetings with Staff and attending a DAT Meeting. We have also had meetings with the Alder and the neighborhood to understand their goals and desires with this redevelopment. These discussions have helped shape the overall design of this project.

Site Development Data:

Densities:

| | |
|-----------------|--|
| Lot Area | 39,464 / 0.9 acres |
| Dwelling Units | 63 DU |
| Lot Area / D.U. | 626 S.F./D.U. |
| Density | 70 units/acre |
| Open Space | 6,069 S.F. (2,520 S.F. Min. Required) |
| Lot Coverage | 33,519 S.F. = 85% (33,544 S.F. 85% Max Required) |

Building Height: 3 and 4 Stories

Gross Floor Areas:

| | |
|------------------|-------------|
| Residential Area | 61,595 S.F. |
| Commercial Area | 10,377 S.F. |

Floor Area Ratio 1.82

Dwelling Unit Mix:

| | |
|-----------------------------|----------|
| Efficiency | 49 |
| One Bedroom | 37 |
| One Bedroom + Den | 3 |
| Two Bedroom | 8 |
| <u>Two Bedroom Townhome</u> | <u>5</u> |
| Total Dwelling Units | 63 |

Vehicle Parking:

| | |
|--------------------|------------------|
| Surface | 23 stalls* |
| <u>Underground</u> | <u>37 stalls</u> |
| Total | 60 stalls |

Bicycle Parking:

| | |
|--------------------------------------|------------------|
| Protected and Secure Stalls | 63 stalls |
| Surface Stalls for Visitors | 7 stalls |
| <u>Surface Stalls for Commercial</u> | <u>25 stalls</u> |
| Total | 95 stalls |

Project Schedule:

It is anticipated that the construction on this site will start in May 2021 with a final completion of May 2022.

Thank you for your time reviewing our proposal.

Sincerely,



Kevin Burow, AIA, NCARB, LEED AP
Managing Member

From: Stacey Oehrke
Sent: Friday, May 15, 2020 3:51 PM
To: Evers, Tag; mononabayneighborhoodassoc@gmail.com
Cc: Kevin Burow; vnapresident@gmail.com; kcarlson2@wisc.edu; John Perkins; leaj833@gmail.com
Subject: RE: Lucky's 1313 Regent St Project

Great thank you!

Thank you,

Stacey Oehrke | Permit Specialist | Knothe & Bruce Architects, LLC | Ph: 608.836.3690 (Ex. 115)
7601 University Avenue, Middleton, WI 53562 | soehrke@knothebruce.com

From: Evers, Tag <district13@cityofmadison.com>
Sent: Friday, May 15, 2020 3:12 PM
To: Stacey Oehrke <soehrke@knothebruce.com>; mononabayneighborhoodassoc@gmail.com
Cc: Kevin Burow <KBurow@knothebruce.com>; vnapresident@gmail.com; kcarlson2@wisc.edu; John Perkins <perkinsj71@gmail.com>; leaj833@gmail.com
Subject: Re: Lucky's 1313 Regent St Project

Hi Stacey,

This project is not in the Monona Bay neighborhood, but rather in Greenbush, on the border of Vilas.

I have folks from VNA and GNA on copy.

Thanks.

Tag Evers

DISTRICT 13 ALDER
CITY OF MADISON
(608) 424-2580
district13@cityofmadison.com

Subscribe to my blog at www.cityofmadison.com/council/district13/blog

From: Stacey Oehrke <soehrke@knothebruce.com>

Sent: Friday, May 15, 2020 2:19 PM

To: Evers, Tag; mononabayneighborhoodassoc@gmail.com; mononabayneighborhoodassoc@gmail.com

Cc: Kevin Burow

Subject: Lucky's 1313 Regent St Project

Caution: This email was sent from an external source. Avoid unknown links and attachments.

Hello,

I would like to take this opportunity to formally notify you we plan on submitting our land use application on June 17, 2020 We are proposing expand the current Lucky's 1313 by adding 50 apartment units above and behind the existing building while also providing approximately 38 underground parking stalls and 24 surface parking stalls.

We look forward to working with you in making this a successful development.
If you have any questions please contact Kevin Burow 608-836-3690.

Thank you for your time.

Thank you,

Stacey Oehrke | Permit Specialist | Knothe & Bruce Architects, LLC | Ph: 608.836.3690 (Ex. 115)
7601 University Avenue, Middleton, WI 53562 | soehrke@knothebruce.com



D-Series Size 1 LED Wall Luminaire



Catalog
Number

Notes

Type

Hit the Tab key or mouse over the page to see all interactive elements.

d#series

Specifications Luminaire

| | | | |
|----------------|----------------------|----------------|--------------------|
| Width: | 13-3/4" (34.9 cm) | Weight: | 12 lbs (5.4 kg) |
| Depth: | 10" (25.4 cm) | | |
| Height: | 6-3/8" (16.2 cm) | | |

Back Box (BBW, ELCW)

| | | | |
|----------------|----------------------|---------------------|--------------------|
| Width: | 13-3/4" (34.9 cm) | BBW Weight: | 5 lbs (2.3 kg) |
| Depth: | 4" (10.2 cm) | ELCW Weight: | 10 lbs (4.5 kg) |
| Height: | 6-3/8" (16.2 cm) | | |

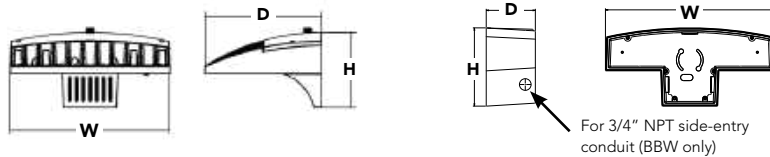

Introduction

The D-Series Wall luminaire is a stylish, fully integrated LED solution for building-mount applications. It features a sleek, modern design and is carefully engineered to provide long-lasting, energy-efficient lighting with a variety of optical and control options for customized performance.

With an expected service life of over 20 years of nighttime use and up to 74% in energy savings over comparable 250W metal halide luminaires, the D-Series Wall is a reliable, low-maintenance lighting solution that produces sites that are exceptionally illuminated.

Ordering Information

EXAMPLE: DSXW1 LED 20C 1000 40K T3M MVOLT DBBTD

| Series | LEDs | Drive Current | Color temperature | Distribution | Voltage | Mounting | Control Options |
|-----------|--|---|--|---|--|---|---|
| DSXW1 LED | 10C 10 LEDs (one engine) 20C 20 LEDs (two engines) ¹ | 350 350 mA 530 530 mA 700 700 mA 1000 1000 mA (1 A) ¹ | 30K 3000 K 40K 4000 K 50K 5000 K AMBPC Amber phosphor converted | T2S Type II Short T2M Type II Medium T3S Type III Short T3M Type III Medium T4M Type IV Medium TFTM Forward Throw Medium | MVOLT ² 120 ³ 208 ³ 240 ³ 277 ³ 347 ^{3,4} 480 ^{3,4} | Shipped included (blank) Surface mounting bracket BBW Surface-mounted back box (for conduit entry) ⁵ | Shipped installed PE Photoelectric cell, button type ⁶ DMG 0-10v dimming wires pulled outside fixture (for use with an external control, ordered separately) PIR 180° motion/ambient light sensor, <15' mtg ht ^{1,7} PIRH 180° motion/ambient light sensor, 15-30' mtg ht ^{1,7} PIR1FC3V Motion/ambient sensor, 8-15' mounting height, ambient sensor enabled at 1fc ^{1,7} PIRH1FC3V Motion/ambient sensor, 15-30' mounting height, ambient sensor enabled at 1fc ^{1,7} ELCW Emergency battery backup (includes external component enclosure), CA Title 20 Noncompliant ^{8,9} |

| Other Options | Finish (required) |
|---|--|
| Shipped installed SF Single fuse (120, 277 or 347V) ^{3,10} DF Double fuse (208, 240 or 480V) ^{3,10} HS House-side shield ¹¹ SPD Separate surge protection ¹² | Shipped separately¹¹ BSW Bird-deterrent spikes VG Vandal guard DDL Diffused drop lens DDBXD Dark bronze DBLXD Black DNAXD Natural aluminum DWHXD White DSSXD Sandstone DDBTXD Textured dark bronze DBLBXD Textured black DNATXD Textured natural aluminum DWHGXD Textured white DSSTXD Textured sandstone |

Accessories

Ordered and shipped separately.

| | |
|-----------|--|
| DSXWHS U | House-side shield (one per light engine) |
| DSXWBSW U | Bird-deterrent spikes |
| DSXWTVG U | Vandal guard accessory |

NOTES

- 20C 1000 is not available with PIR, PIRH, PIR1FC3V or PIRH1FC3V.
- MVOLT driver operates on any line voltage from 120-277V (50/60 Hz).
- Single fuse (SF) requires 120, 277 or 347 voltage option. Double fuse (DF) requires 208, 240 or 480 voltage option.
- Only available with 20C, 700mA or 1000mA. Not available with PIR or PIRH.
- Back box ships installed on fixture. Cannot be field installed. Cannot be ordered as an accessory.
- Photocontrol (PE) requires 120, 208, 240, 277 or 347 voltage option. Not available with motion/ambient light sensors (PIR or PIRH).
- Reference Motion Sensor table on page 3.
- Cold weather (-20C) rated. Not compatible with conduit entry applications. Not available with BBW mounting option. Not available with fusing. Not available with 347 or 480 voltage options. Emergency components located in back box housing. Emergency mode IES files located on product page at www.lithonia.com
- Not available with SPD.
- Not available with ELCW.
- Also available as a separate accessory; see Accessories information.
- Not available with ELCW.



Lumen Output

Lumen values are from photometric tests performed in accordance with IESNA LM-79-08. Data is considered to be representative of the configurations shown, within the tolerances allowed by Lighting Facts. Contact factory for performance data on any configurations not shown here.

| LEDs | Drive Current (mA) | System Watts | Dist. Type | 30K (3000 K, 70CRI) | | | | | 40K (4000 K, 70CRI) | | | | | 50K (5000 K, 70CRI) | | | | | AMBPC (Amber Phosphor Converted) | | | | |
|------------------|--------------------|--------------|------------|---------------------|----|-------|-------|-------|---------------------|----|-------|-------|-------|---------------------|----|-------|-------|-------|----------------------------------|----|----|----|-----|
| | | | | Lumens | B | U | G | LPW | Lumens | B | U | G | LPW | Lumens | B | U | G | LPW | Lumens | B | U | G | LPW |
| 10C (10 LEDs) | 350mA | 13W | T2S | 1,415 | 0 | 0 | 1 | 109 | 1,520 | 0 | 0 | 1 | 117 | 1,530 | 0 | 0 | 1 | 118 | 894 | 0 | 0 | 1 | 69 |
| | | | T2M | 1,349 | 0 | 0 | 1 | 104 | 1,448 | 0 | 0 | 1 | 111 | 1,458 | 0 | 0 | 1 | 112 | 852 | 0 | 0 | 1 | 66 |
| | | | T3S | 1,399 | 0 | 0 | 1 | 108 | 1,503 | 0 | 0 | 1 | 116 | 1,512 | 0 | 0 | 1 | 116 | 884 | 0 | 0 | 1 | 68 |
| | | | T3M | 1,385 | 0 | 0 | 1 | 107 | 1,488 | 0 | 0 | 1 | 114 | 1,497 | 0 | 0 | 1 | 115 | 876 | 0 | 0 | 1 | 67 |
| | | | T4M | 1,357 | 0 | 0 | 1 | 104 | 1,458 | 0 | 0 | 1 | 112 | 1,467 | 0 | 0 | 1 | 113 | 858 | 0 | 0 | 1 | 66 |
| | | | TFTM | 1,411 | 0 | 0 | 1 | 109 | 1,515 | 0 | 0 | 1 | 117 | 1,525 | 0 | 0 | 1 | 117 | 892 | 0 | 0 | 1 | 69 |
| | ASDYF | 1,262 | 1 | 0 | 1 | 97 | 1,354 | 1 | 0 | 1 | 104 | 1,363 | 1 | 0 | 1 | 105 | 797 | 0 | 0 | 1 | 61 | | |
| | 530 mA | 19W | T2S | 2,053 | 1 | 0 | 1 | 108 | 2,205 | 1 | 0 | 1 | 116 | 2,220 | 1 | 0 | 1 | 117 | 1,264 | 0 | 0 | 1 | 67 |
| | | | T2M | 1,957 | 1 | 0 | 1 | 103 | 2,102 | 1 | 0 | 1 | 111 | 2,115 | 1 | 0 | 1 | 111 | 1,205 | 0 | 0 | 1 | 63 |
| | | | T3S | 2,031 | 1 | 0 | 1 | 107 | 2,181 | 1 | 0 | 1 | 115 | 2,194 | 1 | 0 | 1 | 115 | 1,250 | 0 | 0 | 1 | 66 |
| | | | T3M | 2,010 | 1 | 0 | 1 | 106 | 2,159 | 1 | 0 | 1 | 114 | 2,172 | 1 | 0 | 1 | 114 | 1,237 | 0 | 0 | 1 | 65 |
| | | | T4M | 1,970 | 1 | 0 | 1 | 104 | 2,115 | 1 | 0 | 1 | 111 | 2,129 | 1 | 0 | 1 | 112 | 1,212 | 0 | 0 | 1 | 64 |
| | | | TFTM | 2,047 | 0 | 0 | 1 | 108 | 2,198 | 1 | 0 | 1 | 116 | 2,212 | 1 | 0 | 1 | 116 | 1,260 | 0 | 0 | 1 | 66 |
| | ASDYF | 1,831 | 1 | 0 | 1 | 96 | 1,966 | 1 | 0 | 1 | 103 | 1,978 | 1 | 0 | 1 | 104 | 1,127 | 0 | 0 | 1 | 59 | | |
| | 700 mA | 26W | T2S | 2,623 | 1 | 0 | 1 | 101 | 2,816 | 1 | 0 | 1 | 108 | 2,834 | 1 | 0 | 1 | 109 | 1,544 | 0 | 0 | 1 | 59 |
| | | | T2M | 2,499 | 1 | 0 | 1 | 96 | 2,684 | 1 | 0 | 1 | 103 | 2,701 | 1 | 0 | 1 | 104 | 1,472 | 0 | 0 | 1 | 57 |
| | | | T3S | 2,593 | 1 | 0 | 1 | 100 | 2,785 | 1 | 0 | 1 | 107 | 2,802 | 1 | 0 | 1 | 108 | 1,527 | 0 | 0 | 1 | 59 |
| | | | T3M | 2,567 | 1 | 0 | 1 | 99 | 2,757 | 1 | 0 | 1 | 106 | 2,774 | 1 | 0 | 1 | 107 | 1,512 | 0 | 0 | 1 | 58 |
| | | | T4M | 2,515 | 1 | 0 | 1 | 97 | 2,701 | 1 | 0 | 1 | 104 | 2,718 | 1 | 0 | 1 | 105 | 1,481 | 0 | 0 | 1 | 57 |
| | | | TFTM | 2,614 | 1 | 0 | 1 | 101 | 2,808 | 1 | 0 | 1 | 108 | 2,825 | 1 | 0 | 1 | 109 | 1,539 | 0 | 0 | 1 | 59 |
| | ASDYF | 2,337 | 1 | 0 | 1 | 90 | 2,510 | 1 | 0 | 1 | 97 | 2,525 | 1 | 0 | 1 | 97 | 1,376 | 1 | 0 | 1 | 53 | | |
| | 1000 mA | 39W | T2S | 3,685 | 1 | 0 | 1 | 94 | 3,957 | 1 | 0 | 1 | 101 | 3,982 | 1 | 0 | 1 | 102 | 2,235 | 1 | 0 | 1 | 57 |
| | | | T2M | 3,512 | 1 | 0 | 1 | 90 | 3,771 | 1 | 0 | 1 | 97 | 3,794 | 1 | 0 | 1 | 97 | 2,130 | 1 | 0 | 1 | 55 |
| | | | T3S | 3,644 | 1 | 0 | 1 | 93 | 3,913 | 1 | 0 | 1 | 100 | 3,938 | 1 | 0 | 1 | 101 | 2,210 | 1 | 0 | 1 | 57 |
| T3M | | | 3,607 | 1 | 0 | 1 | 92 | 3,873 | 1 | 0 | 1 | 99 | 3,898 | 1 | 0 | 1 | 100 | 2,187 | 1 | 0 | 1 | 56 | |
| T4M | | | 3,534 | 1 | 0 | 2 | 91 | 3,796 | 1 | 0 | 2 | 97 | 3,819 | 1 | 0 | 2 | 98 | 2,143 | 1 | 0 | 1 | 55 | |
| TFTM | | | 3,673 | 1 | 0 | 1 | 94 | 3,945 | 1 | 0 | 1 | 101 | 3,969 | 1 | 0 | 1 | 102 | 2,228 | 1 | 0 | 1 | 57 | |
| ASDYF | 3,284 | 1 | 0 | 2 | 84 | 3,527 | 1 | 0 | 2 | 90 | 3,549 | 1 | 0 | 2 | 91 | 1,992 | 1 | 0 | 1 | 51 | | | |
| 20C (20 LEDs) | 350mA | 23W | T2S | 2,820 | 1 | 0 | 1 | 123 | 3,028 | 1 | 0 | 1 | 132 | 3,047 | 1 | 0 | 1 | 132 | 1,777 | 1 | 0 | 1 | 77 |
| | | | T2M | 2,688 | 1 | 0 | 1 | 117 | 2,886 | 1 | 0 | 1 | 125 | 2,904 | 1 | 0 | 1 | 126 | 1,693 | 1 | 0 | 1 | 74 |
| | | | T3S | 2,789 | 1 | 0 | 1 | 121 | 2,994 | 1 | 0 | 1 | 130 | 3,014 | 1 | 0 | 1 | 131 | 1,757 | 0 | 0 | 1 | 76 |
| | | | T3M | 2,760 | 1 | 0 | 1 | 120 | 2,965 | 1 | 0 | 1 | 129 | 2,983 | 1 | 0 | 1 | 130 | 1,739 | 1 | 0 | 1 | 76 |
| | | | T4M | 2,704 | 1 | 0 | 1 | 118 | 2,905 | 1 | 0 | 1 | 126 | 2,922 | 1 | 0 | 1 | 127 | 1,704 | 1 | 0 | 1 | 74 |
| | | | TFTM | 2,811 | 1 | 0 | 1 | 122 | 3,019 | 1 | 0 | 1 | 131 | 3,038 | 1 | 0 | 1 | 132 | 1,771 | 0 | 0 | 1 | 77 |
| | ASDYF | 2,514 | 1 | 0 | 1 | 109 | 2,699 | 1 | 0 | 1 | 117 | 2,716 | 1 | 0 | 1 | 118 | 1,584 | 1 | 0 | 1 | 69 | | |
| | 530 mA | 35W | T2S | 4,079 | 1 | 0 | 1 | 117 | 4,380 | 1 | 0 | 1 | 125 | 4,407 | 1 | 0 | 1 | 126 | 2,504 | 1 | 0 | 1 | 72 |
| | | | T2M | 3,887 | 1 | 0 | 1 | 111 | 4,174 | 1 | 0 | 1 | 119 | 4,201 | 1 | 0 | 1 | 120 | 2,387 | 1 | 0 | 1 | 68 |
| | | | T3S | 4,033 | 1 | 0 | 1 | 115 | 4,331 | 1 | 0 | 1 | 124 | 4,359 | 1 | 0 | 1 | 125 | 2,477 | 1 | 0 | 1 | 71 |
| | | | T3M | 3,993 | 1 | 0 | 2 | 114 | 4,288 | 1 | 0 | 2 | 123 | 4,315 | 1 | 0 | 2 | 123 | 2,451 | 1 | 0 | 1 | 70 |
| | | | T4M | 3,912 | 1 | 0 | 2 | 112 | 4,201 | 1 | 0 | 2 | 120 | 4,227 | 1 | 0 | 2 | 121 | 2,402 | 1 | 0 | 1 | 69 |
| | | | TFTM | 4,066 | 1 | 0 | 2 | 116 | 4,366 | 1 | 0 | 2 | 125 | 4,394 | 1 | 0 | 2 | 126 | 2,496 | 1 | 0 | 1 | 71 |
| | ASDYF | 3,636 | 1 | 0 | 2 | 104 | 3,904 | 1 | 0 | 2 | 112 | 3,928 | 1 | 0 | 2 | 112 | 2,232 | 1 | 0 | 1 | 64 | | |
| | 700 mA | 46W | T2S | 5,188 | 1 | 0 | 1 | 113 | 5,572 | 1 | 0 | 1 | 121 | 5,607 | 1 | 0 | 1 | 122 | 3,065 | 1 | 0 | 1 | 67 |
| | | | T2M | 4,945 | 1 | 0 | 2 | 108 | 5,309 | 1 | 0 | 2 | 115 | 5,343 | 1 | 0 | 2 | 116 | 2,921 | 1 | 0 | 1 | 64 |
| | | | T3S | 5,131 | 1 | 0 | 2 | 112 | 5,510 | 1 | 0 | 2 | 120 | 5,544 | 1 | 0 | 2 | 121 | 3,031 | 1 | 0 | 1 | 66 |
| | | | T3M | 5,078 | 1 | 0 | 2 | 110 | 5,454 | 1 | 0 | 2 | 119 | 5,487 | 1 | 0 | 2 | 119 | 3,000 | 1 | 0 | 1 | 65 |
| | | | T4M | 4,975 | 1 | 0 | 2 | 108 | 5,343 | 1 | 0 | 2 | 116 | 5,376 | 1 | 0 | 2 | 117 | 2,939 | 1 | 0 | 1 | 64 |
| | | | TFTM | 5,172 | 1 | 0 | 2 | 112 | 5,554 | 1 | 0 | 2 | 121 | 5,589 | 1 | 0 | 2 | 122 | 3,055 | 1 | 0 | 1 | 66 |
| | ASDYF | 4,624 | 1 | 0 | 2 | 101 | 4,965 | 1 | 0 | 2 | 108 | 4,996 | 1 | 0 | 2 | 109 | 2,732 | 1 | 0 | 1 | 59 | | |
| | 1000 mA | 73W | T2S | 7,204 | 1 | 0 | 2 | 99 | 7,736 | 2 | 0 | 2 | 106 | 7,784 | 2 | 0 | 2 | 107 | 4,429 | 1 | 0 | 1 | 61 |
| | | | T2M | 6,865 | 1 | 0 | 2 | 94 | 7,373 | 2 | 0 | 2 | 101 | 7,419 | 2 | 0 | 2 | 102 | 4,221 | 1 | 0 | 1 | 58 |
| | | | T3S | 7,125 | 1 | 0 | 2 | 98 | 7,651 | 1 | 0 | 2 | 105 | 7,698 | 1 | 0 | 2 | 105 | 4,380 | 1 | 0 | 1 | 60 |
| T3M | | | 7,052 | 1 | 0 | 2 | 97 | 7,573 | 2 | 0 | 2 | 104 | 7,620 | 2 | 0 | 2 | 104 | 4,335 | 1 | 0 | 2 | 59 | |
| T4M | | | 6,909 | 1 | 0 | 2 | 95 | 7,420 | 1 | 0 | 2 | 102 | 7,466 | 1 | 0 | 2 | 102 | 4,248 | 1 | 0 | 2 | 58 | |
| TFTM | | | 7,182 | 1 | 0 | 2 | 98 | 7,712 | 1 | 0 | 2 | 106 | 7,761 | 1 | 0 | 2 | 106 | 4,415 | 1 | 0 | 2 | 60 | |
| ASDYF | 6,421 | 2 | 0 | 2 | 88 | 6,896 | 2 | 0 | 3 | 94 | 6,938 | 2 | 0 | 3 | 95 | 3,947 | 1 | 0 | 2 | 54 | | | |

Performance Data

Lumen Ambient Temperature (LAT) Multipliers

Use these factors to determine relative lumen output for average ambient temperatures from 0-40°C (32-104°F).

| Ambient | | Lumen Multiplier |
|---------|-------|------------------|
| 0°C | 32°F | 1.02 |
| 10°C | 50°F | 1.01 |
| 20°C | 68°F | 1.00 |
| 25°C | 77°F | 1.00 |
| 30°C | 86°F | 1.00 |
| 40°C | 104°F | 0.98 |

Projected LED Lumen Maintenance

Data references the extrapolated performance projections for the DSXW1 LED 20C 1000 platform in a 25°C ambient, based on 10,000 hours of LED testing (tested per IESNA LM-80-08 and projected per IESNA TM-21-11).

To calculate LLF, use the lumen maintenance factor that corresponds to the desired number of operating hours below. For other lumen maintenance values, contact factory.

| Operating Hours | 0 | 25,000 | 50,000 | 100,000 |
|--------------------------|-----|--------|--------|---------|
| Lumen Maintenance Factor | 1.0 | 0.95 | 0.93 | 0.88 |

Electrical Load

| LEDs | Drive Current (mA) | System Watts | Current (A) | | | | | |
|------|--------------------|--------------|-------------|------|------|------|------|------|
| | | | 120V | 208V | 240V | 277V | 347V | 480V |
| 10C | 350 | 14 W | 0.13 | 0.07 | 0.06 | 0.06 | - | - |
| | 530 | 20 W | 0.19 | 0.11 | 0.09 | 0.08 | - | - |
| | 700 | 27 W | 0.25 | 0.14 | 0.13 | 0.11 | - | - |
| | 1000 | 40 W | 0.37 | 0.21 | 0.19 | 0.16 | - | - |
| 20C | 350 | 24 W | 0.23 | 0.13 | 0.12 | 0.10 | - | - |
| | 530 | 36 W | 0.33 | 0.19 | 0.17 | 0.14 | - | - |
| | 700 | 47 W | 0.44 | 0.25 | 0.22 | 0.19 | 0.15 | 0.11 |
| | 1000 | 74 W | 0.69 | 0.40 | 0.35 | 0.30 | 0.23 | 0.17 |

Motion Sensor Default Settings

| Option | Dimmed State | High Level (when triggered) | Photocell Operation | Dwell Time | Ramp-up Time | Ramp-down Time |
|-----------------------|-----------------|-----------------------------|---------------------|------------|--------------|----------------|
| *PIR or PIRH | 3V (37%) Output | 10V (100%) Output | Enabled @ 5FC | 5 min | 3 sec | 5 min |
| PIR1FC3V or PIRH1FC3V | 3V (37%) Output | 10V (100%) Output | Enabled @ 1FC | 5 min | 3 sec | 5 min |

*for use with site wide Dusk to Dawn control

Photometric Diagrams

To see complete photometric reports or download .ies files for this product, visit Lithonia Lighting's [D-Series Wall Size 1 homepage](#).

Isfootcandle plots for the DSXW1 LED 20C 1000 40K. Distances are in units of mounting height (15').

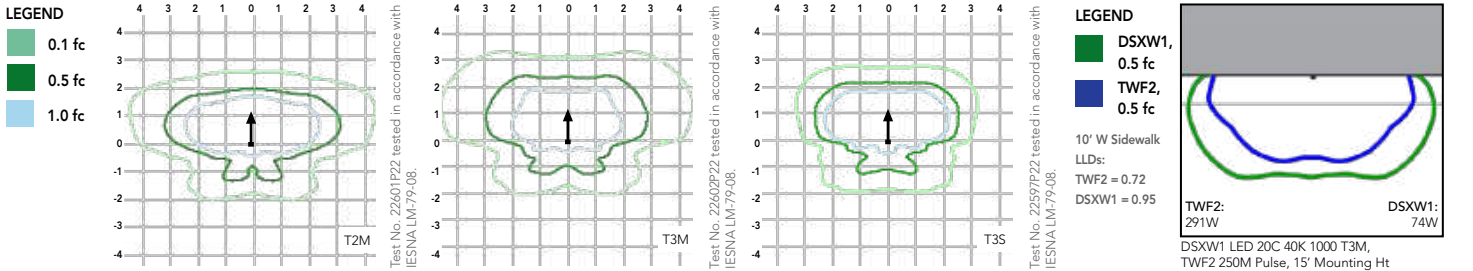

Options and Accessories



T3M (left), ASYDF (right) lenses



HS - House-side shields



BSW - Bird-deterrent spikes



WG - Wire guard



VG - Vandal guard



DDL - Diffused drop lens

FEATURES & SPECIFICATIONS

INTENDED USE

The energy savings, long life and easy-to-install design of the D-Series Wall Size 1 make it the smart choice for building-mounted doorway and pathway illumination for nearly any facility.

CONSTRUCTION

Two-piece die-cast aluminum housing has integral heat sink fins to optimize thermal management through conductive and convective cooling. Modular design allows for ease of maintenance. The LED driver is mounted to the door to thermally isolate it from the light engines for low operating temperature and long life. Housing is completely sealed against moisture and environmental contaminants (IP65).

FINISH

Exterior parts are protected by a zinc-infused Super Durable TGIC thermoset powder coat finish that provides superior resistance to corrosion and weathering. A tightly controlled multi-stage process ensures a minimum 3 mils thickness for a finish that can withstand extreme climate changes without cracking or peeling. Available in textured and non-textured finishes.

OPTICS

Precision-molded proprietary acrylic lenses provide multiple photometric distributions tailored specifically to building mounted applications. Light engines are available in 3000 K (70 min. CRI), 4000 K (70 min. CRI) or 5000 K (70 min. CRI) configurations.

ELECTRICAL

Light engine(s) consist of 10 high-efficacy LEDs mounted to a metal-core circuit board to maximize heat dissipation and promote long life (L88/100,000 hrs at 25°C). Class 1 electronic drivers have a power factor >90%, THD <20%, and a minimum 2.5KV surge rating. When ordering the SPD option, a separate surge protection device is installed within the luminaire which meets a minimum Category C Low (per ANSI/IEEE C62.41.2).

INSTALLATION

Included universal mounting bracket attaches securely to any 4" round or square outlet box for quick and easy installation. Luminaire has a slotted gasket wireway and attaches to the mounting bracket via corrosion-resistant screws.

LISTINGS

CSA certified to U.S. and Canadian standards. Rated for -40°C minimum ambient.

DesignLights Consortium® (DLC) qualified product. Not all versions of this product may be DLC qualified. Please check the DLC Qualified Products List at www.designlights.org/QPL to confirm which versions are qualified.

WARRANTY

Five-year limited warranty. Complete warranty terms located at: www.acuitybrands.com/support/customer-support/terms-and-conditions

Note: Actual performance may differ as a result of end-user environment and application. All values are design or typical values, measured under laboratory conditions at 25 °C. Specifications subject to change without notice.



COMMERCIAL OUTDOOR

One Lithonia Way • Conyers, Georgia 30012 • Phone: 1-800-705-SERV (7378) • www.lithonia.com
© 2013-2020 Acuity Brands Lighting, Inc. All rights reserved.

DSXW1-LED
Rev. 2/05/20



CITY OF MADISON LANDSCAPE WORKSHEET

Section 28.142 Madison General Ordinance

Project Location / Address 1313 Regent Street
 Name of Project Lucky's 1313 Expansion
 Owner / Contact Matt Saltzberry, PLA - D'Onofrio Kottke (Landscape Architect)
 Contact Phone 608-833-7530 Contact Email msaltzberry@donofrio.cc

**** Landscape plans for zoning lots greater than ten thousand (10,000) square feet in size MUST be prepared by a registered landscape architect. ****

Applicability

The following standards apply to all exterior construction and development activity, including the expansion of existing buildings, structures and parking lots, except the construction of detached single-family and two-family dwellings and their accessory structures. The entire development site must be brought up to compliance with this section unless **all** of the following conditions apply, in which case only the affected areas need to be brought up to compliance:

- (a) The area of site disturbance is less than ten percent (10%) of the entire development site during any ten-(10) year period.
- (b) Gross floor area is only increased by ten percent (10%) during any ten-(10) year period.
- (c) No demolition of a principal building is involved.
- (d) Any displaced landscaping elements must be replaced on the site and shown on a revised landscaping plan.

Landscape Calculations and Distribution

Required landscaped areas shall be calculated based upon the total developed area of the property. Developed area is defined as that area within a single contiguous boundary which is made up of structures, parking, driveways and docking/loading facilities, but excluding the area of any building footprint at grade, land designated for open space uses such as athletic fields, and undeveloped land area on the same zoning lot. There are three methods for calculating landscape points depending on the size of the lot and Zoning District.

- (a) For all lots except those described in (b) and (c) below, five (5) landscape points shall be provided for each three hundred (300) square feet of developed area.

Total square footage of developed area 18,675 SF

Total landscape points required 311

- (b) **For lots larger than five (5) acres**, points shall be provided at five (5) points per three hundred (300) square feet for the first five (5) developed acres, and one (1) point per one hundred (100) square feet for all additional acres.

Total square footage of developed area _____

Five (5) acres = 217,800 square feet

First five (5) developed acres = 3,630 points

Remainder of developed area _____

Total landscape points required _____

- (c) **For the Industrial – Limited (IL) and Industrial – General (IG) districts**, one (1) point shall be provided per one hundred (100) square feet of developed area.

Total square footage of developed area _____

Total landscape points required _____

Tabulation of Points and Credits

Use the table to indicate the quantity and points for all existing and proposed landscape elements.

| Plant Type/ Element | Minimum Size at Installation | Points | Credits/ Existing Landscaping | | New/ Proposed Landscaping | |
|---|--|---|-------------------------------|-----------------|---------------------------|-----------------|
| | | | Quantity | Points Achieved | Quantity | Points Achieved |
| Overstory deciduous tree | 2½ inch caliper measured diameter at breast height (dbh) | 35 | - | - | 4 | 140 |
| Tall evergreen tree (i.e. pine, spruce) | 5-6 feet tall | 35 | - | - | - | - |
| Ornamental tree | 1 1/2 inch caliper | 15 | - | - | - | - |
| Upright evergreen shrub (i.e. arborvitae) | 3-4 feet tall | 10 | - | - | - | - |
| Shrub, deciduous | #3 gallon container size, Min. 12”-24” | 3 | - | - | 40 | 120 |
| Shrub, evergreen | #3 gallon container size, Min. 12”-24” | 4 | - | - | 37 | 148 |
| Ornamental grasses/ perennials | #1 gallon container size, Min. 8”-18” | 2 | - | - | 84 | 168 |
| Ornamental/ decorative fencing or wall | n/a | 4 per 10 lineal ft. | - | - | - | - |
| Existing significant specimen tree | Minimum size: 2 ½ inch caliper dbh. *Trees must be within developed area and cannot comprise more than 30% of total required points. | 14 per caliper inch dbh. Maximum points per tree: 200 | - | - | - | - |
| Landscape furniture for public seating and/or transit connections | * Furniture must be within developed area, publically accessible, and cannot comprise more than 5% of total required points. | 5 points per “seat” | - | - | - | - |
| Sub Totals | | | | - | | 576 |

Total Number of Points Provided 576

* As determined by ANSI, ANLA- American standards for nursery stock. For each size, minimum plant sizes shall conform to the specifications as stated in the current American Standard for Nursery Stock.

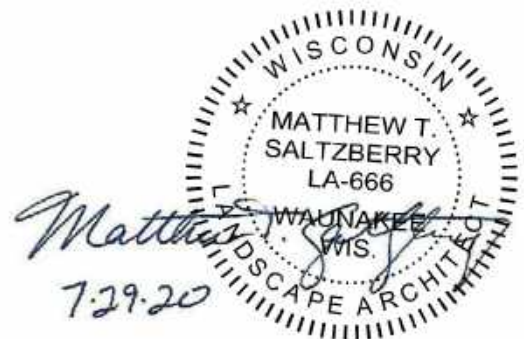

EXISTING PHOTOS
LUCKY'S 1313 BREW PUB EXPANSION

1313 Regent Street / Lucky's Brew Pub



Bowen Court / Lucky's Brew Pub Parking Lot, Patio & Volleyball Courts



Bowen Court / Lucky's Brew Pub Parking Lot, Patio & Volleyball Courts



S. Randall Avenue / Lucky's surface parking lot





Current Aerial
Lucky's
1313 Regent St., Madison, WI
June 9, 2020





Concept Site Plan
Lucky's
1313 Regent St., Madison, WI
June 9, 2020





SITE LOCATOR MAP

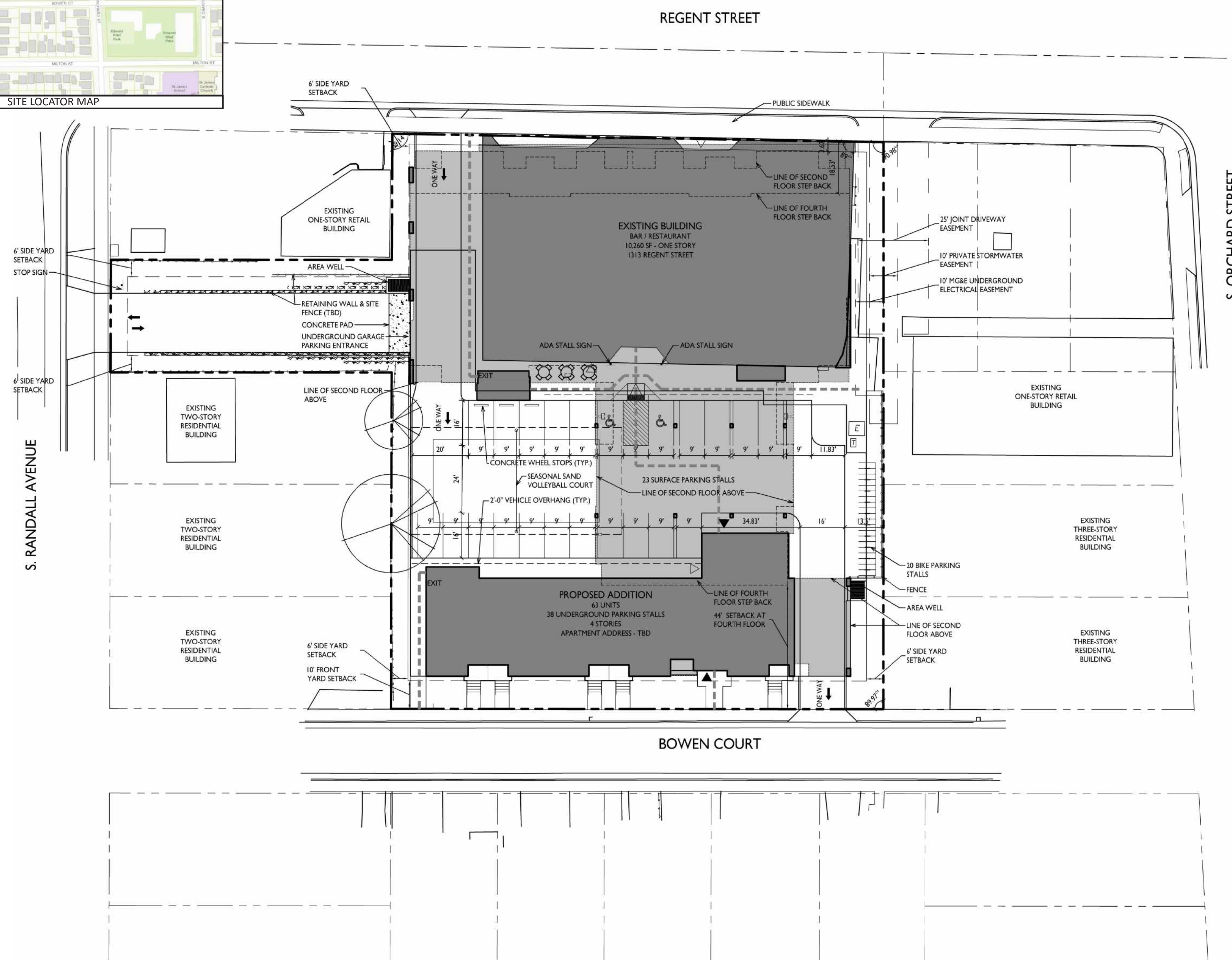

SITE PLAN
C-1.1
1" = 20'-0"

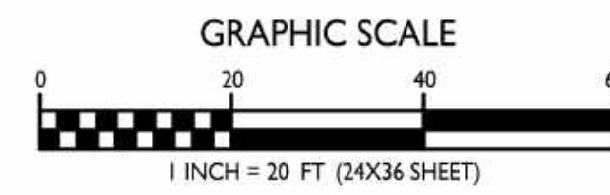

REGENT STREET

S. ORCHARD STREET

S. RANDALL AVENUE

BOWEN COURT

- GENERAL NOTES:**
1. THE APPLICANT SHALL REPLACE ALL SIDEWALK AND CURB AND GUTTER THAT ABUTS THE PROPERTY THAT IS DAMAGED BY THE CONSTRUCTION, OR ANY SIDEWALK AND CURB AND GUTTER WHICH THE CITY ENGINEER DETERMINES NEEDS TO BE REPLACED BECAUSE IT IS NOT AT A DESIRABLE GRADE, REGARDLESS OF WHETHER THE CONDITION EXISTED PRIOR TO BEGINNING CONSTRUCTION.
 2. ALL WORK IN THE PUBLIC RIGHT OF WAY SHALL BE PERFORMED BY A CITY-LICENSED CONTRACTOR.
 3. ALL DAMAGE TO THE PAVEMENT ON CITY STREETS, AND ADJACENT TO THIS DEVELOPMENT SHALL BE RESTORED IN ACCORDANCE WITH THE CITY OF MADISON'S PAVEMENT PATCHING CRITERIA.
 4. EXISTING STREET TREES SHALL BE PROTECTED. CONTRACTOR SHALL INSTALL TREE PROTECTION FENCING IN THE AREA BETWEEN THE CURB AND SIDEWALK AND EXTEND IT AT LEAST 5 FEET FROM BOTH SIDES OF THE TREE ALONG THE LENGTH OF THE TERRACE. NO EXCAVATION IS PERMITTED WITHIN 5 FEET OF THE OUTSIDE EDGE OF THE TREE TRUNK. IF EXCAVATION WITHIN 5 FEET OF ANY TREE IS NECESSARY, CONTRACTOR SHALL CONTACT CITY FORESTRY (266-4816) PRIOR TO EXCAVATION TO ASSESS THE IMPACT TO THE TREE AND ROOT SYSTEM. TREE PRUNING SHALL BE COORDINATED WITH CITY FORESTRY. TREE PROTECTION SPECIFICATIONS CAN BE FOUND IN SECTION 107.13 OF CITY OF MADISON STANDARD SPECIFICATIONS FOR PUBLIC WORKS CONSTRUCTION.
 5. APPROVAL OF PLANS FOR THIS PROJECT DOES NOT INCLUDE ANY APPROVAL TO PRUNE, REMOVE, OR PLANT TREES IN THE PUBLIC RIGHT-OF-WAY. PERMISSION FOR SUCH ACTIVITIES MUST BE OBTAINED FROM THE CITY FORESTER (266-4816).
 6. THE PUBLIC RIGHT-OF-WAY IS THE SOLE JURISDICTION OF THE CITY OF MADISON AND IS SUBJECT TO CHANGE AT ANY TIME. NO ITEMS SHOWN ON THIS SITE PLAN IN THE RIGHT-OF-WAY ARE PERMANENT AND MAY NEED TO BE REMOVED AT THE APPLICANTS EXPENSE UPON NOTIFICATION BY THE CITY.

Site Development Data: UPDATED 7-16-2020 dq

Zoning: TSS - Traditional Shopping Street

| Densities: | Conditional Use |
|--------------------------|--------------------------|
| Lot Area | 39,464 S.F./0.9 acres |
| Dwelling Units/202 units | |
| Lot Area / D.U. | 626 S.F./unit |
| Density | 70 units/Acre |
| Commercial Area | 10,260 S.F. |
| Usable Open Space | 6,020 S.F. (96S.F./unit) |
| Lot Coverage | 33,612 S.F. (85%) |
| Building Height | 4 stories |
| Dwelling Unit Mix: | Proposed Addition |
| Efficiency | 10 |
| One Bedroom | 37 |
| One Bedroom + Den | 3 |
| Two bedroom | 8 |
| Two Bedroom Townhouse | 5 |
| Total Dwelling Units | 63 |
| Vehicle Parking Stalls: | |
| Underground Garage | 37 |
| Surface | 23 |
| Total | 60 |
| Parking Ratio | 0.95 stalls/unit |
| Bicycle Parking: | |
| Garage - wall mount | 9 |
| Garage - floor mount | 54 |
| Surface-Guest | 20 |
| Total | 83 |

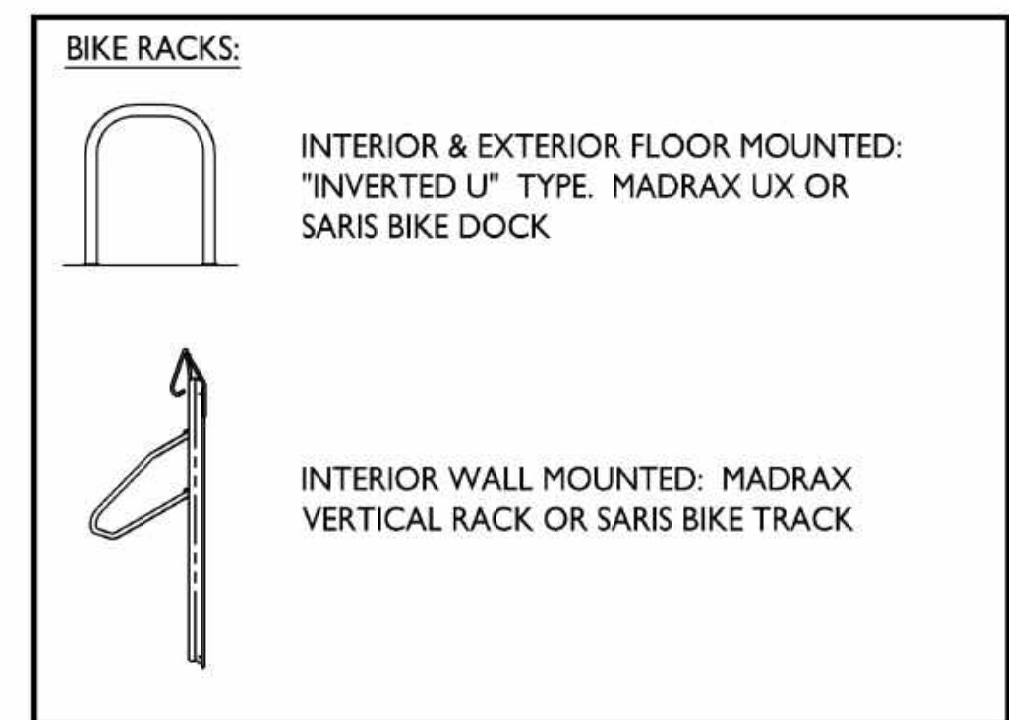

ISSUED
Issued for Land Use Submittal - July 29, 2020

PROJECT TITLE
Lucky's Site Development
Regent & Randall

1313 Regent Street
Madison, Wisconsin
SHEET TITLE
Site Plan

SHEET NUMBER

C-1.1

PROJECT NO. 1916

© Knothe & Bruce Architects, LLC

| STATISTICS | | | | | | |
|---------------------------------|--------|--------|--------|--------|-------------|-------------|
| DESCRIPTION | SYMBOL | AVG. | MAX. | MIN. | MAX. / MIN. | AVG. / MIN. |
| Uncovered Parking Area Lighting | + | 0.5 fc | 0.8 fc | 0.2 fc | 4.0:1 | 2.5:1 |

| LUMINAIRE SCHEDULE | | | | | | | |
|--------------------|-------|------|-------------------|------------------------------------|---|--|--|
| SYMBOL | LABEL | QTY. | MANUF. | CATALOG | DESCRIPTION | FILE | MOUNTING |
| | A | 3 | LITHONIA LIGHTING | DSXW1 LED 10C 350 30K T4M MVOLT HS | DSXW1 LED WITH (1) 10 LED LIGHT ENGINE, TYPE 4M OPTIC, 3000K, AT 350mA WITH HOUSE-SIDE SHIELD | DSXW1_LED_10C_350_30K_T4M_MVOLT_HS.ies | MOUNTED ON BUILDING 16'-0" ABOVE GRADE |

EXAMPLE LIGHT FIXTURE DISTRIBUTION

- ISOLUX CONTOUR = 0.25 FC
- ISOLUX CONTOUR = 0.5 FC
- ISOLUX CONTOUR = 1.0 FC
- LIGHT FIXTURE

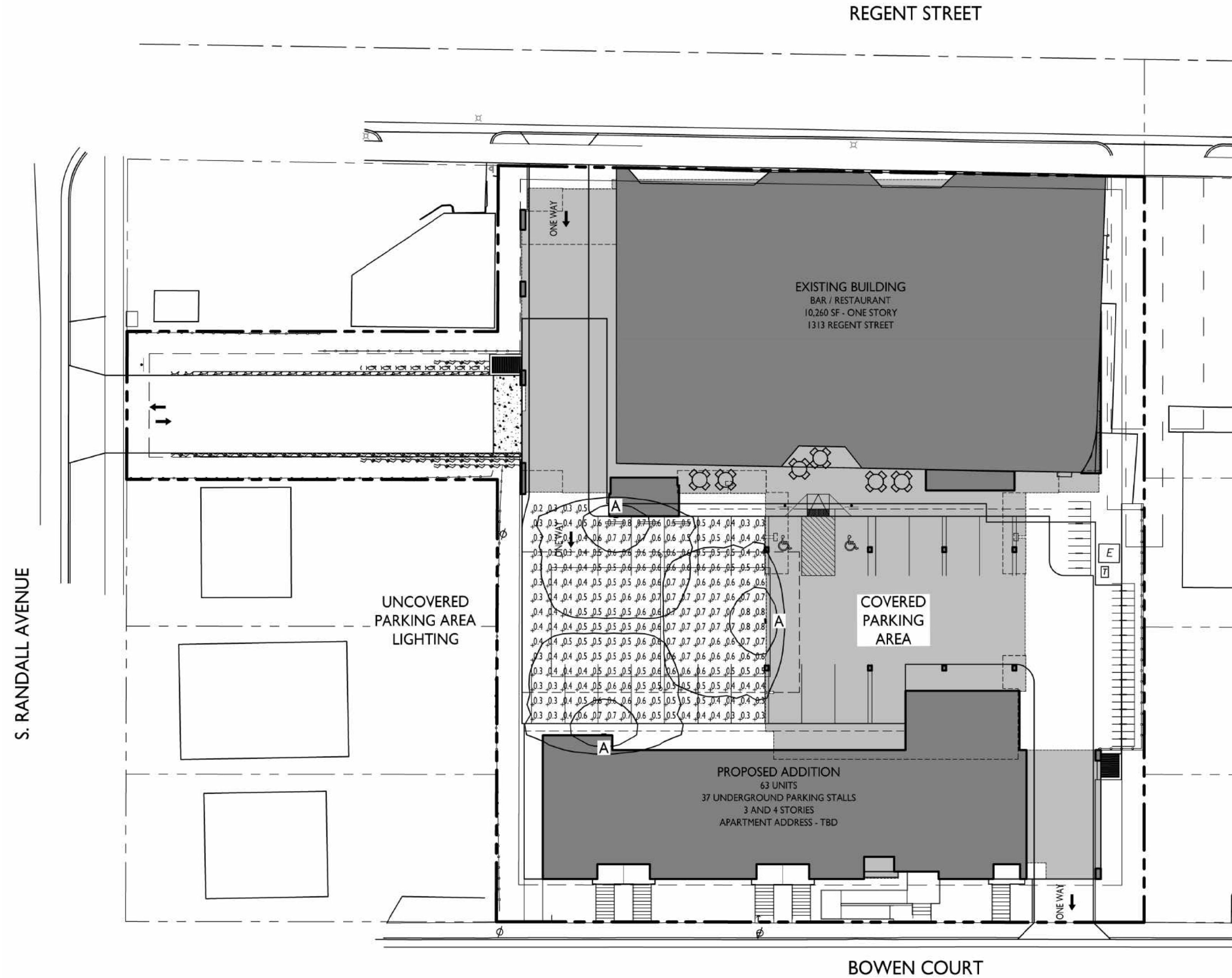

1 SITE LIGHTING PLAN
 C-1.2 1" = 20'-0"

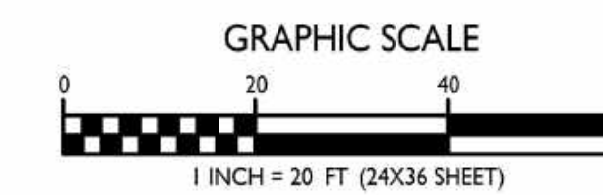
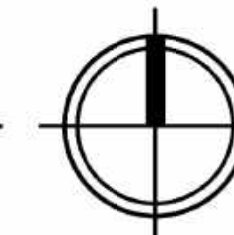

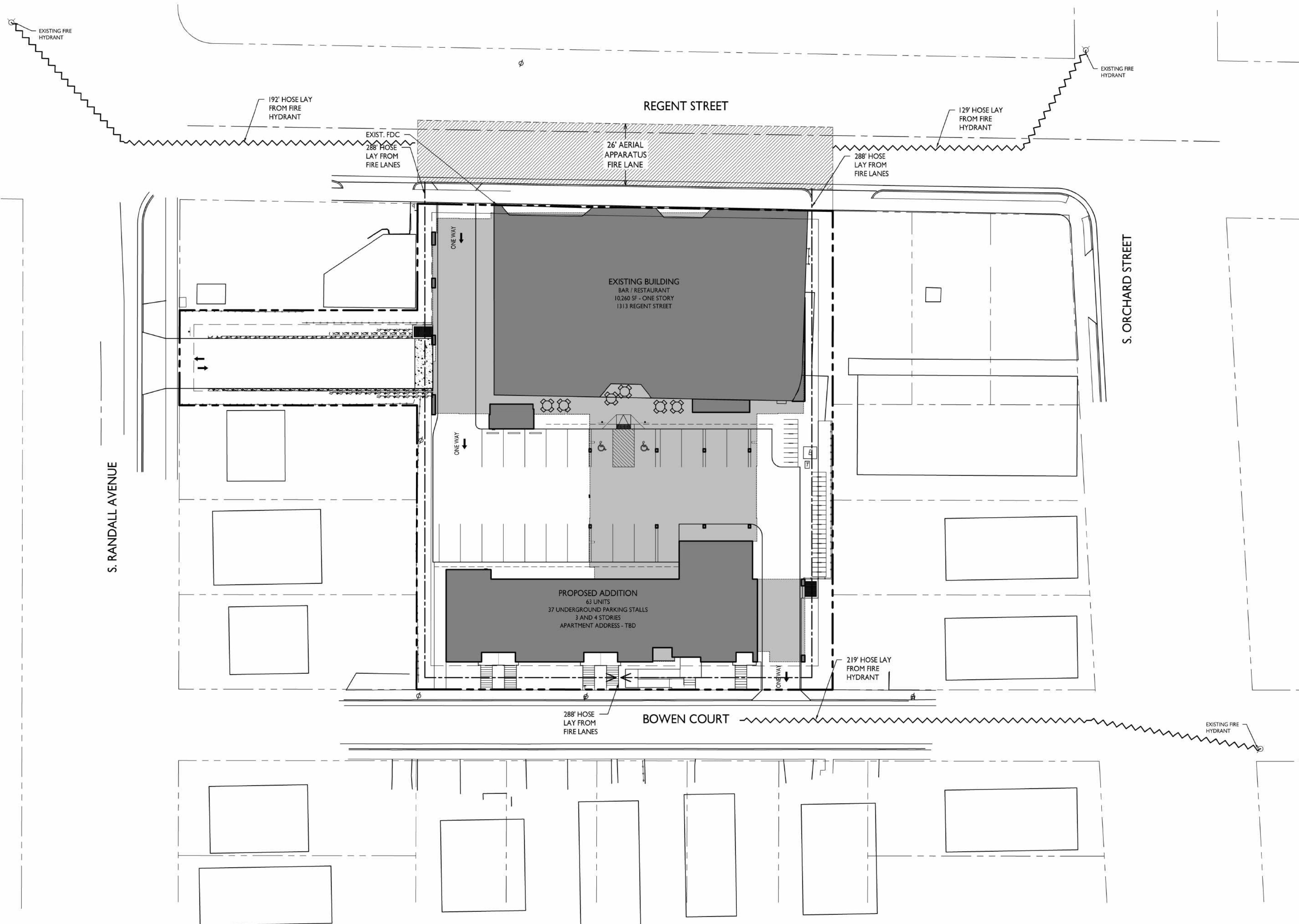

1
C-1.3

FIRE DEPARTMENT ACCESS PLAN

1" = 20'-0"

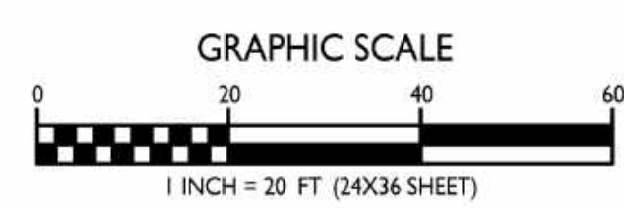

ISSUED
Issued for Land Use Submittal - July 29, 2020

PROJECT TITLE
**Lucky's 1313
Expansion**

1313 Regent Street
Madison, Wisconsin
SHEET TITLE
**Fire Department
Access Plan**

SHEET NUMBER

C-1.3

PROJECT NO. **1916**
© Knothe & Bruce Architects, LLC

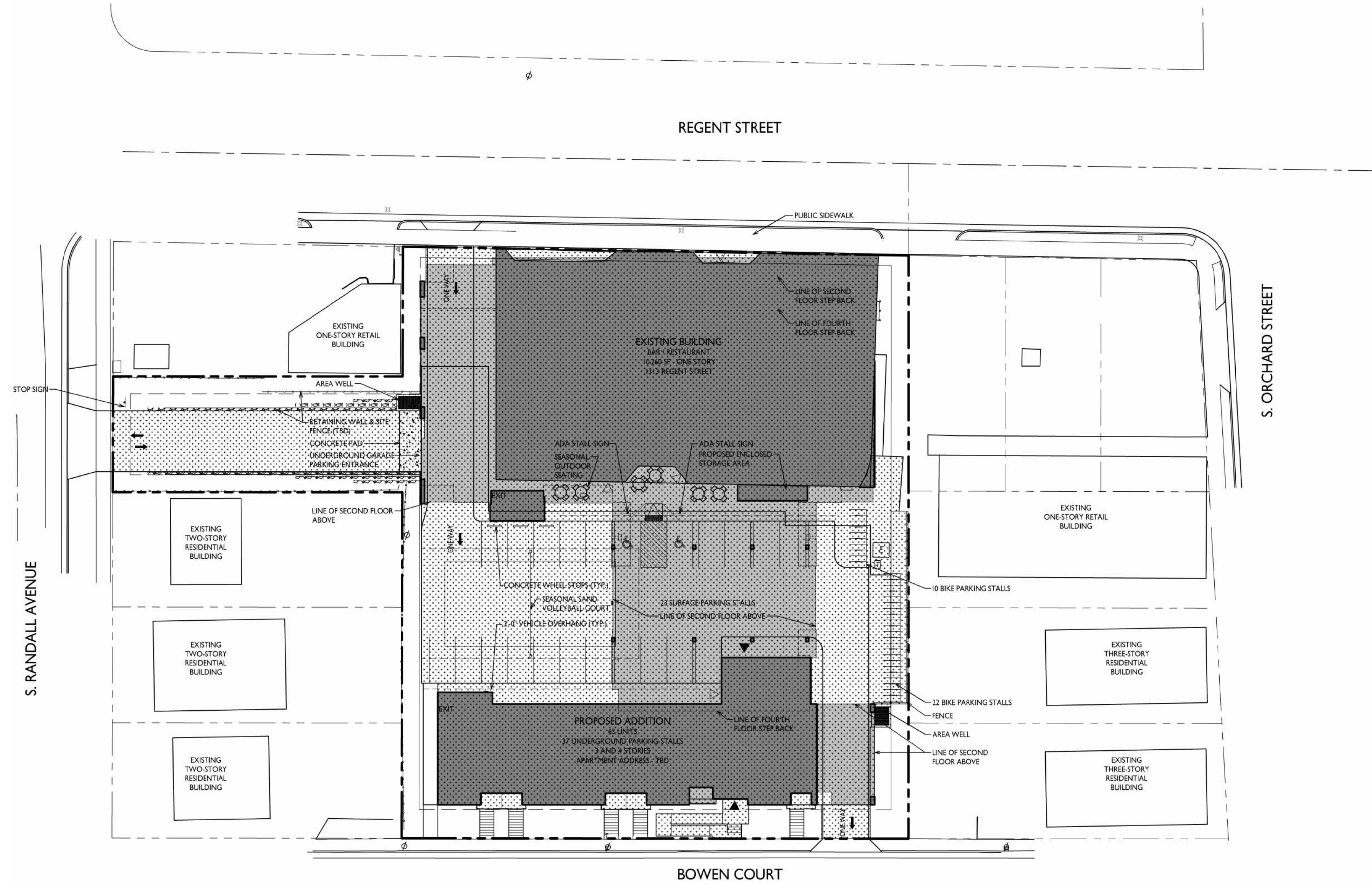

LOT COVERAGE
C-1.4 1" = 40'-0"

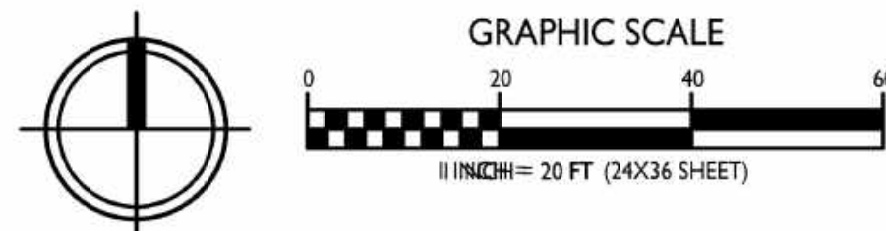

LOT COVERAGE
ZONING: TSS
MAXIMUM LOT COVERAGE: 85%
LOT AREA: 39,464 S.F.
PROPOSED COVERAGE: 33,519 S.F. / 85%

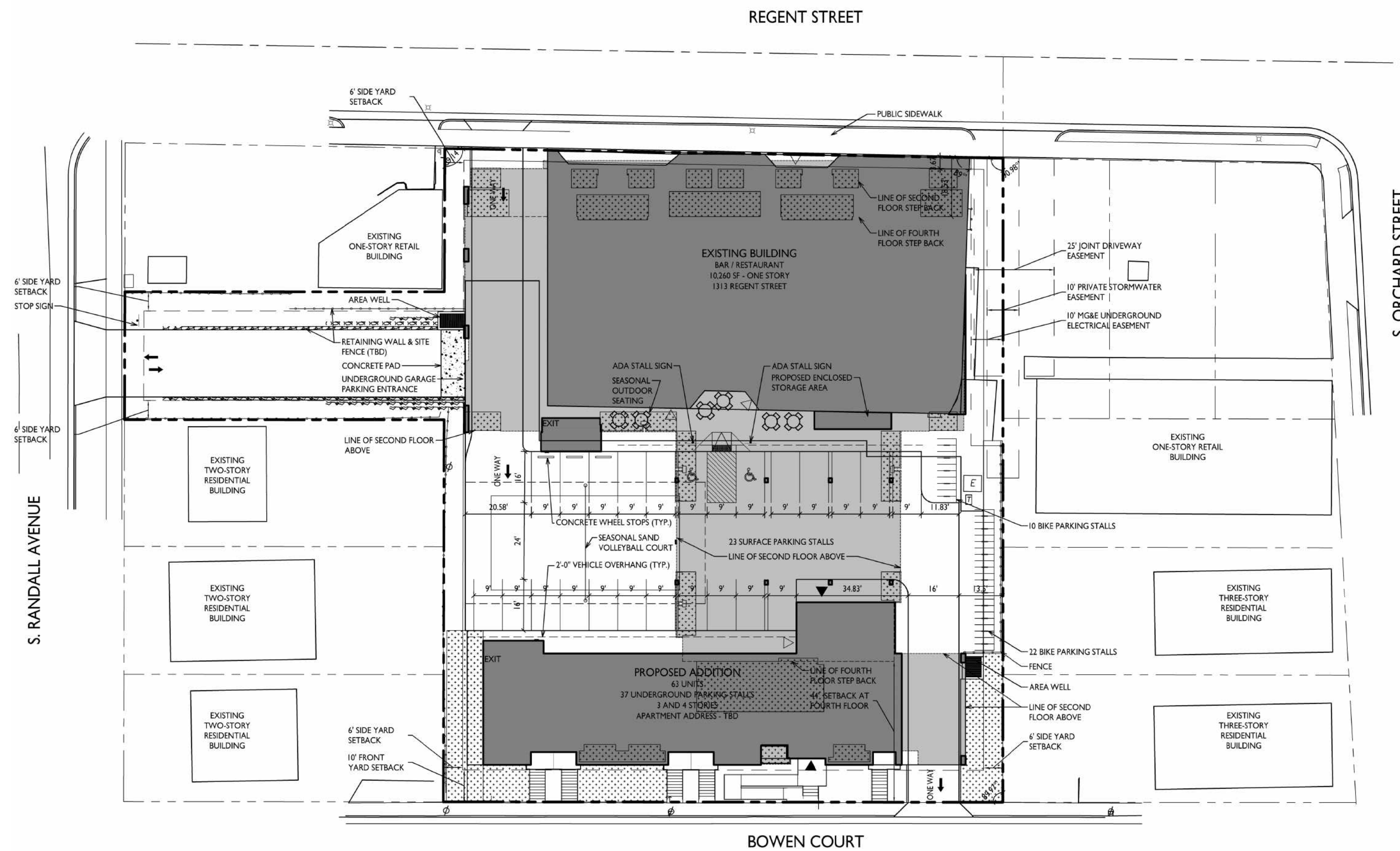

USABLE OPEN SPACE

ZONING: TSS

REQUIRED OPEN SPACE: 40 S.F. / D.U.

DWELLING UNITS: 63

40 X 63 = 2,520 S.F. OPEN SPACE REQUIRED

OPEN SPACE PROVIDED:

ROOF DECK: 636 S.F.

PRIVATE BALCONIES: 3,817 S.F.

SURFACE: 1,616 S.F.

TOTAL: 6,069 S.F.

ISSUED
 Issued for Land Use Submittal - July 29, 2020

PROJECT TITLE
Lucky's 1313
 Expansion

1313 Regent Street
 Madison, Wisconsin

SHEET TITLE
Usable Open
Space

SHEET NUMBER

C-1.5

PROJECT NO. **1916**
 © Knothe & Bruce Architects, LLC

USABLE OPEN SPACE
 C-1.5 1" = 20'-0"

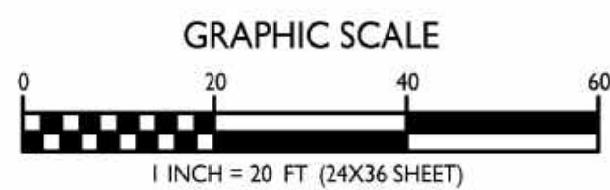
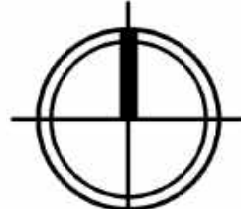

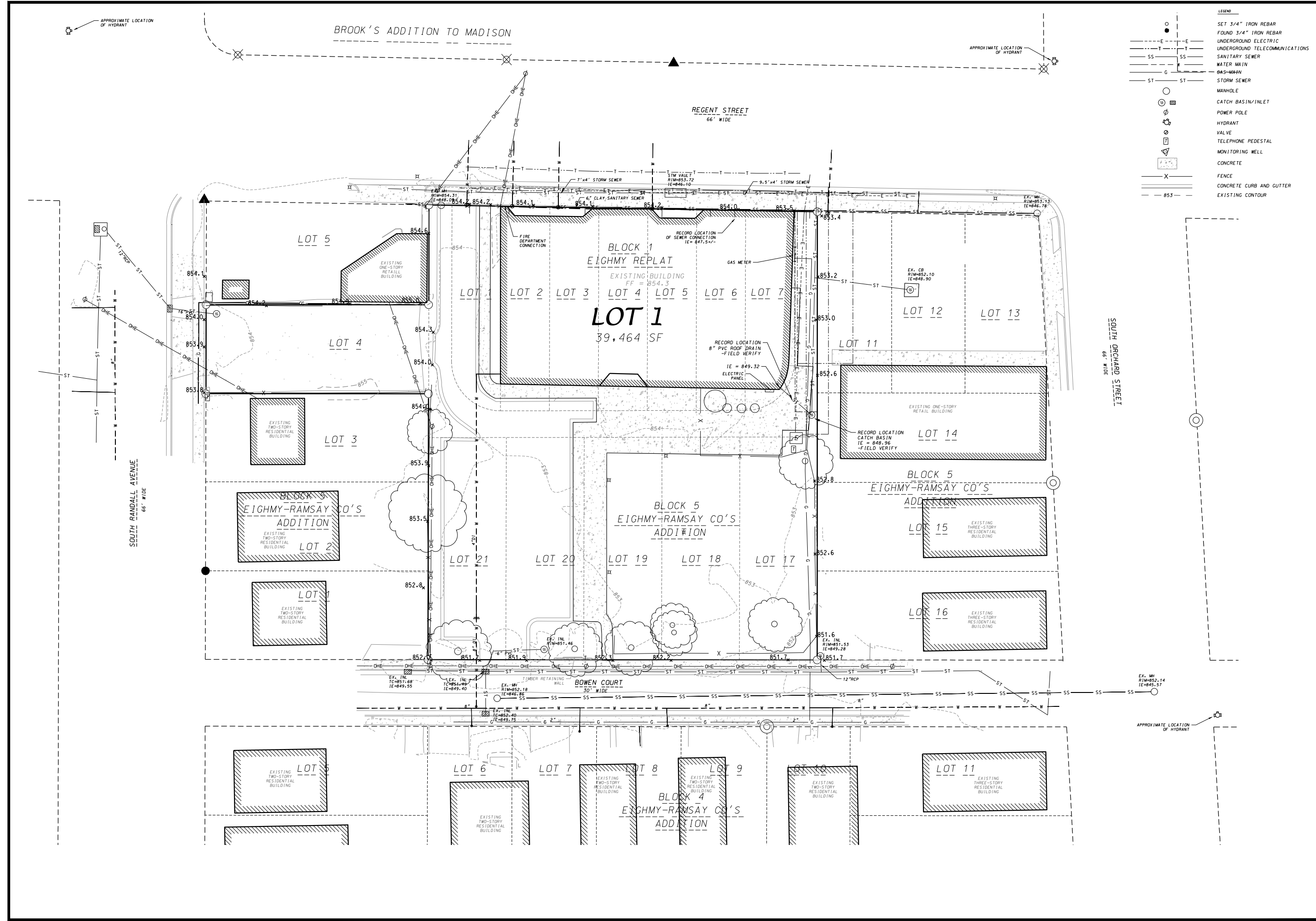

LEGEND

- SET 3/4" IRON REBAR
- FOUND 3/4" IRON REBAR
- UNDERGROUND ELECTRIC
- UNDERGROUND TELECOMMUNICATIONS
- SANITARY SEWER
- WATER MAIN
- GAS-MAIN
- STORM SEWER
- MANHOLE
- CATCH BASIN/INLET
- POWER POLE
- HYDRANT
- VALVE
- TELEPHONE PESTAL
- MONITORING WELL
- CONCRETE
- FENCE
- CONCRETE CURB AND GUTTER
- EXISTING CONTOUR

D'ONOFRIO KOTTKE AND ASSOCIATES, INC.
 7530 Westwood Way, Madison, WI 53717
 Phone: 608.833.7530 • Fax: 608.833.1089
 YOUR NATURAL RESOURCE FOR LAND DEVELOPMENT

EXISTING CONDITIONS
LUCKY'S 1313 EXPANSION

CITY OF MADISON, DANE COUNTY, WISCONSIN



SCALE: 1" = 20'
 (PAGE SIZE: 22X34)

DATE: 07/29/2020
 REVISED:

DRAWN BY: KJP

FN: 20-05-130

Sheet Number:
C-2.1

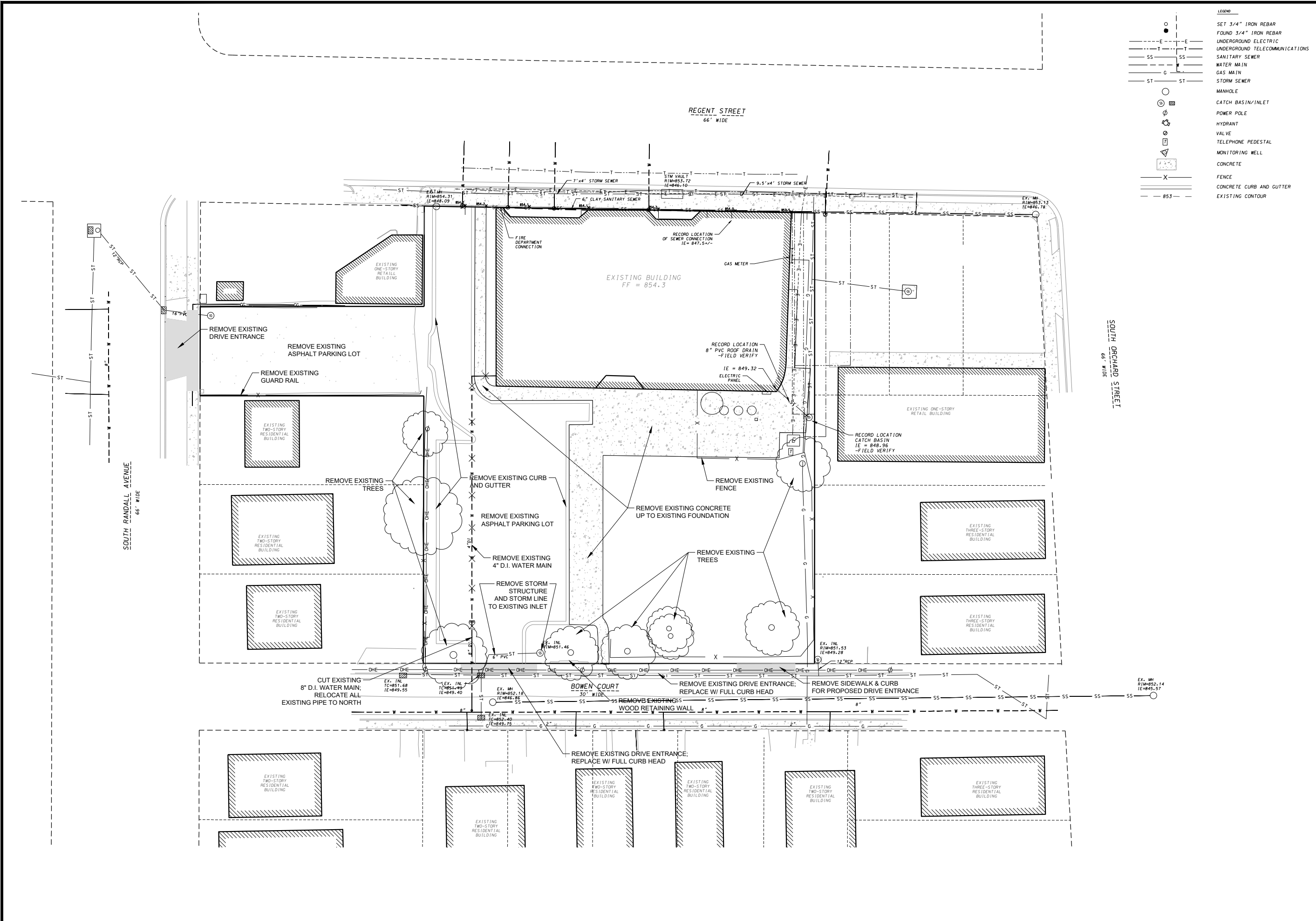

LEGEND

| | |
|--|-------------------------------------|
| | SET 3/4" IRON REBAR |
| | FOUND 3/4" IRON REBAR |
| | UNDERGROUND ELECTRIC COMMUNICATIONS |
| | SANITARY SEWER |
| | WATER MAIN |
| | GAS MAIN |
| | STORM SEWER |
| | MANHOLE |
| | CATCH BASIN/INLET |
| | POWER POLE |
| | HYDRANT |
| | VALVE |
| | TELEPHONE PEDESTAL |
| | MONITORING WELL |
| | CONCRETE |
| | FENCE |
| | CONCRETE CURB AND GUTTER |
| | EXISTING CONTOUR |

D'ONOFRIO KOTTKE AND ASSOCIATES, INC.
 7530 Westwood Way, Madison, WI 53717
 Phone: 608.833.7530 • Fax: 608.833.1089
 YOUR NATURAL RESOURCE FOR LAND DEVELOPMENT

DEMOLITION PLAN
LUCKY'S 1313 EXPANSION
 CITY OF MADISON, DANE COUNTY, WISCONSIN

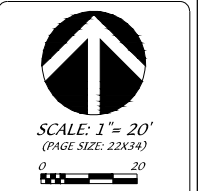

DATE: 07/29/2020
 REVISED:
 DRAWN BY: KJP
 FN: 20-05-130
 Sheet Number:
 C-2.2

REGENT STREET

S. ORCHARD STREET

S. RANDALL AVENUE

LEGEND

- LIMITS OF DISTURBANCE
- RIGHT-OF-WAY
- LOT LINE
- EXISTING FENCE
- PROPOSED CONCRETE CURB & GUTTER
- EXISTING PAVEMENT
- EXISTING INDEX CONTOUR
- EXISTING INTERMEDIATE CONTOUR
- PROPOSED INDEX CONTOUR
- PROPOSED INTERMEDIATE CONTOUR
- PROPOSED STORM SEWER
- SILT FENCE

1.) EROSION CONTROL AND SITE GRADING SCHEDULE:

EROSION CONTROL = MAY 1, 2021
 SITE GRADING = MAY 2 - JUNE 1, 2021
 BUILDING CONSTRUCTION - MAY 15, 2021 - MAY 1, 2022
 UTILITY CONSTRUCTION = JUNE 1, 2021
 PARKING CONSTRUCTION = SEPTEMBER 1, 2021
 RESTORATION = SEPTEMBER 1, 2021 - MAY 15, 2022

2.) COMPLETION DATES ARE TO BE ABIDED BY AND FAILURE TO MEET DEADLINES CONSTITUTES A VIOLATION OF THE PERMIT AND POSSIBLE ISSUANCE OF A STOP WORK ORDER. ANY PROPOSED MODIFICATIONS TO APPROVED PLANS OR ALTERATIONS TO ACCEPTED SEQUENCING OF LAND DISTURBING ACTIVITIES AT THE SITE SHALL BE APPROVED BY THE CITY ENGINEER PRIOR TO IMPLEMENTATION OF SAID CHANGES.

3.) AT THE COMMENCEMENT OF CONSTRUCTION, THE CONTRACTOR SHALL INSTALL THE TRACKING PAD. THE PAD SHALL BE 50' LONG AND 1' THICK, CONSTRUCTED WITH A MINIMUM 3" CLEAR STONE. ADDITIONAL TRACKING PAD MATERIAL SHALL BE INSTALLED AS NEEDED AND THE ENTRANCE SHALL BE MAINTAINED BY THE CONTRACTOR IN A CONDITION THAT WILL PREVENT THE TRACKING OF MUD ONTO THE EXISTING STREET SURFACES AT NO ADDITIONAL COST TO THE OWNER. ALL ADJACENT PUBLIC STREETS SHALL BE INSPECTED AND CLEANED AT THE END OF EACH WORKDAY. ADDITIONAL CONSTRUCTION ENTRANCES MAY BE ALLOWED WITH THE APPROVAL OF THE CITY ENGINEER.

4.) FLEXSTORM INLET PROTECTION SHALL BE INSTALLED IN ALL STORM INLETS SHOWN AND SHALL BE MAINTAINED THROUGH SITE IMPROVEMENTS. THE FILTER SHALL BE INSPECTED AFTER EVERY RAINFALL AND CLEANED AS NECESSARY. THESE PROTECTIONS SHALL BE REMOVED BY THE CONTRACTOR ONCE AN ESTABLISHED CATCH OF GRASS HAS GROWN IN THE TERRACES.

5.) ALL DISTURBED AREAS SHALL BE RESTORED WITH TOPSOIL, SEED, FERTILIZER, AND MULCH. SEED SHALL BE PLACED PER THE REQUIREMENTS OF SECTION 630 IN THE WDOT STANDARD SPECIFICATIONS. SEED SHALL BE WDOT MIXTURE 40 APPLIED AT 2 POUNDS PER 1000 SQUARE FEET.

6.) ALL FERTILIZER SHALL BE WDOT TYPE A APPLIED AT 7 POUNDS PER 1000 SQUARE FEET.

7.) MULCH SHALL BE HAY OR STRAW APPLIED AT A RATE OF 2 TONS PER ACRE DISCED IN PLACE. CHANGES TO ABOVE TYPES SHALL BE APPROVED BY THE ENGINEER.

8.) EROSION CONTROL MATTING IS REQUIRED IN ALL DRAINAGEWAYS AND AREAS WITH A SLOPE OF 4:1 OR GREATER. EROSION MATTING SHALL BE NORTH AMERICAN GREEN S150 OR EQUAL.

9.) EROSION CONTROL IS THE RESPONSIBILITY OF THE CONTRACTOR UNTIL ACCEPTANCE OF THIS PROJECT BY THE CITY. EROSION CONTROL MEASURES AS SHOWN ON THE APPROVED PLAN SHALL BE THE MINIMUM PRECAUTIONS THAT WILL BE ALLOWED. THE CONTRACTOR SHALL BE RESPONSIBLE FOR RECOGNIZING AND CORRECTING EROSION CONTROL PROBLEMS THAT ARE A RESULT OF CONSTRUCTION ACTIVITIES.

10.) PUBLIC STREETS SHALL BE CLEANED AND SWEEPED AS NECESSARY AT THE END OF EACH WORKDAY.

11.) ADDITIONAL EROSION CONTROL MEASURES, AS REQUESTED IN WRITING BY THE CITY INSPECTOR OR THE OWNERS' ENGINEER, SHALL BE INSTALLED WITHIN 24 HOURS.

SPOT ELEVATION KEY

| | |
|--------|--------|
| A' TOW | 854.30 |
| A' EOP | 842.85 |
| B' TOW | 854.30 |
| B' EOP | 842.79 |
| C' TOW | 854.30 |
| C' EOP | 842.99 |
| D' TOW | 854.30 |
| D' EOP | 853.75 |
| E' TOW | 854.30 |
| E' EOP | 853.72 |
| F' TOW | 853.95 |
| F' EOP | 853.95 |
| G' TOW | 853.88 |
| G' EOP | 853.88 |

NOTE:
 CONTRACTOR SHALL FIELD FIT FINAL STEP TO BLEND TO EXISTING SIDEWALK ELEVATION.

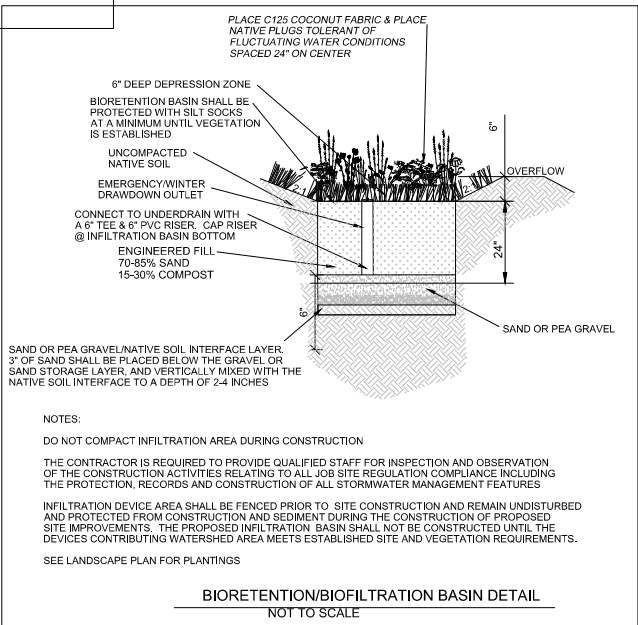
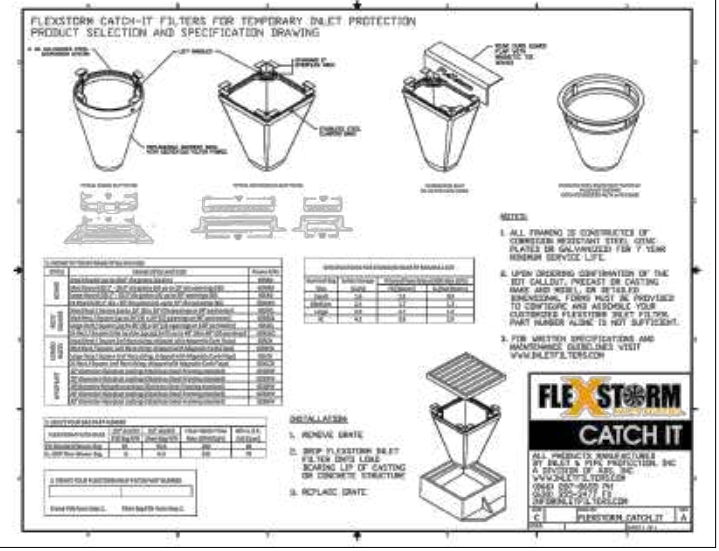
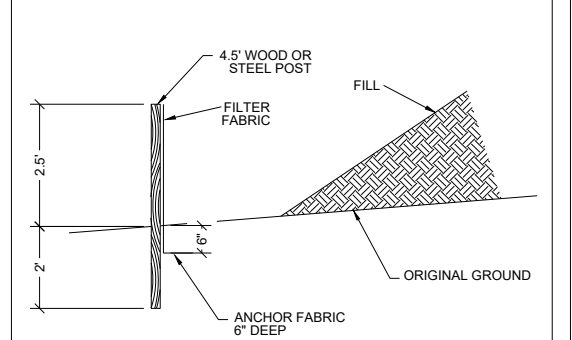
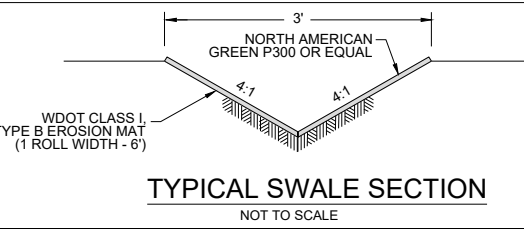
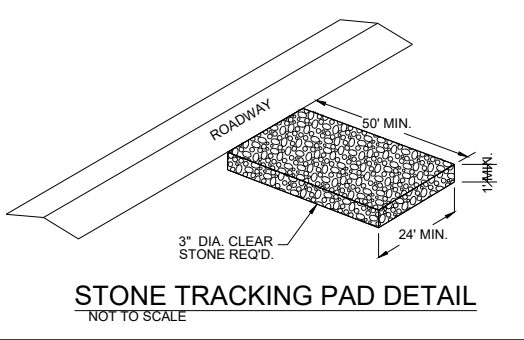

NOTE:
 BOW = BACK OF WALK
 EOP = EDGE OF PAVEMENT
 TC = TOP, BACK OF CURB
 TOW = TOP, BACK OF WALL
 SW = SIDEWALK

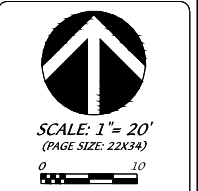

DATE: 07/29/2020
 REVISED:

DRAWN BY: KJP
 FN: 20-05-130
 Sheet Number:
 C-2.3

D'ONOFRIO KOTTKE AND ASSOCIATES, INC.
 7550 Watkiss Way, Madison, WI 53717
 Phone: 608.833.7550 • Fax: 608.833.1089
 YOUR NATURAL RESOURCE FOR LAND DEVELOPMENT

LUCKY'S 1313 EXPANSION

CITY OF MADISON, DANE COUNTY, WISCONSIN

UTILITY PLAN

LEGEND

| | |
|--|--------------------------------|
| | SET 3/4" IRON REBAR |
| | FOUND 3/4" IRON REBAR |
| | UNDERGROUND ELECTRIC |
| | UNDERGROUND TELECOMMUNICATIONS |
| | SANITARY SEWER |
| | WATER MAIN |
| | GAS MAIN |
| | STORM SEWER |
| | MANHOLE |
| | CATCH BASIN/INLET |
| | POWER POLE |
| | HYDRANT |
| | VALVE |
| | TELEPHONE PEDESTAL |
| | MONITORING WELL |
| | CONCRETE |
| | FENCE |
| | CONCRETE CURB AND GUTTER |
| | EXISTING CONTOUR |

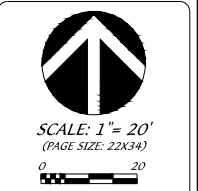
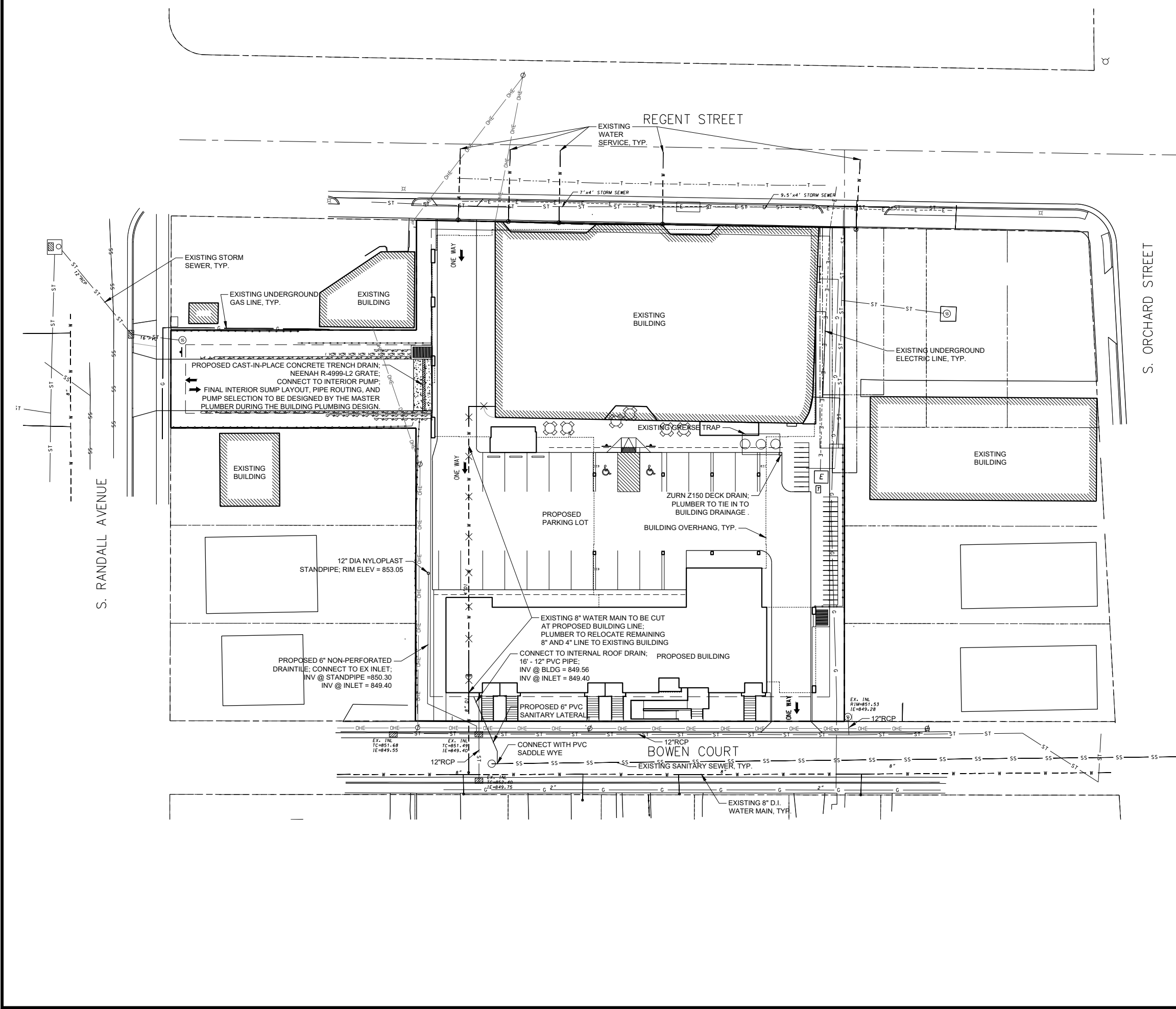
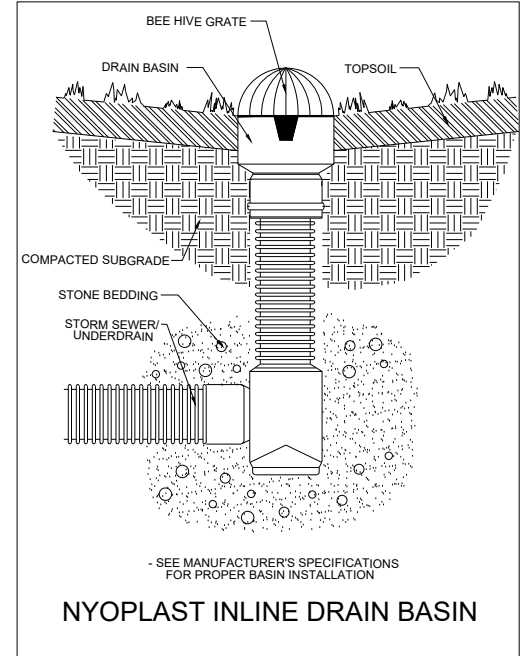

DATE: 07/29/2020
 REVISED:

DRAWN BY: KJP
 FN: 20-05-130
 Sheet Number:
 C-2.4

REGENT STREET

S. RANDALL AVENUE

BOWEN COURT

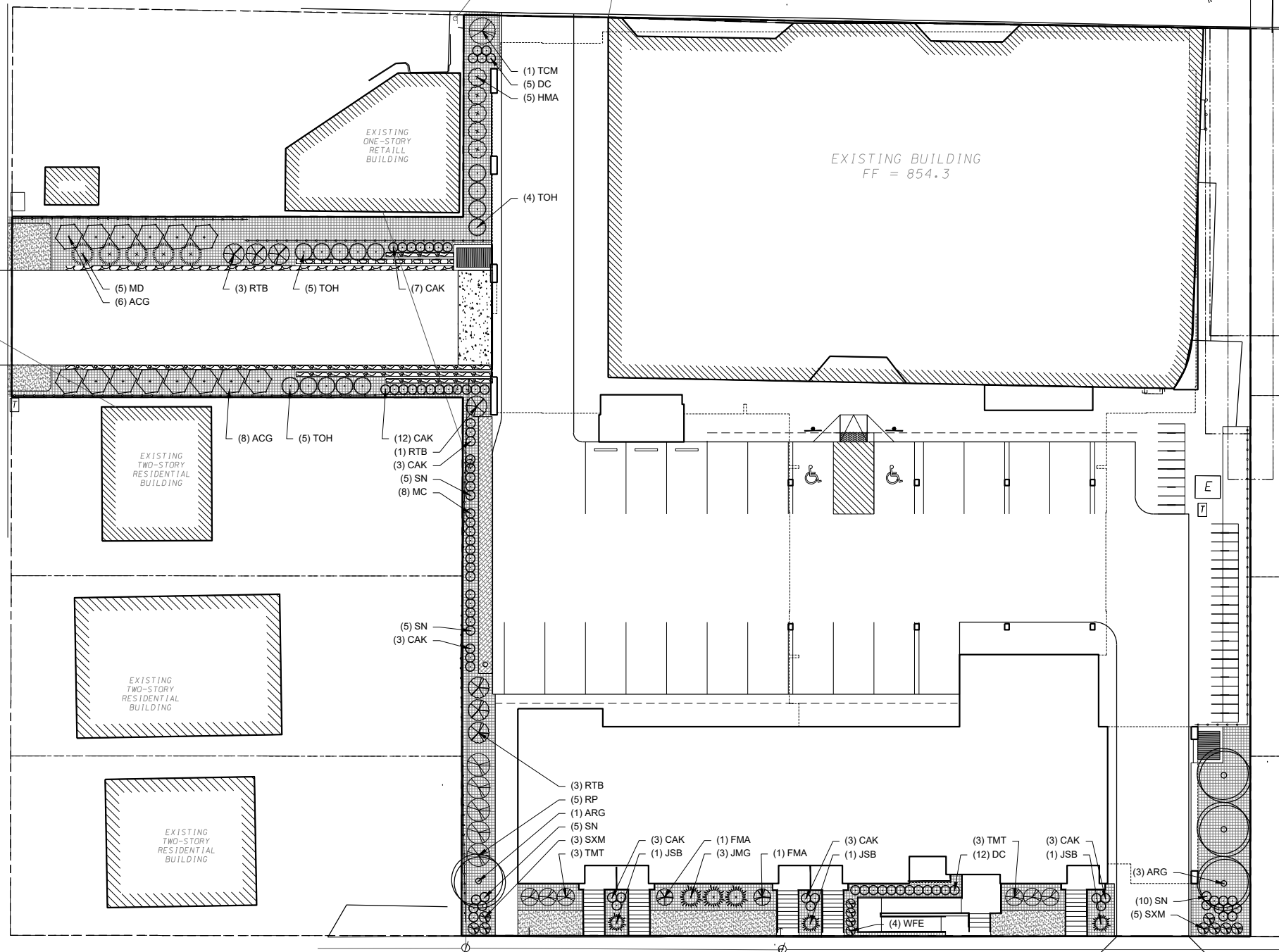

LANDSCAPE REQUIREMENTS SUMMARY

DEVELOPED AREA REQUIREMENT:
5 POINTS PER 300 SF OF DEVELOPED AREA
DEVELOPED AREA = 18,675 SQ FT

TOTAL POINTS REQUIRED = 311 POINTS

POINTS PROVIDED = 576 POINTS

PLANTING SCHEDULE

| CODE | SCIENTIFIC NAME | COMMON NAME | QTY | PTS PER PLANT | SUB-TOTAL | SIZE | ROOT COND. |
|-----------------------------------|-------------------------------|----------------------------------|---------------|---------------|---------------|----------|------------|
| OVER-STORY DECIDUOUS TREES | | | | | | | |
| AKC | Acer rubrum 'Armstrong Red' | Armstrong Red Maple | 4 | 30 | 120 | 12" TALL | POT |
| ACG | Acer glabrum 'Glabrum' | Banker's Silver Maple | 14 | 3 | 42 | 48" TALL | POT |
| FMA | Fragaria virginiana | Wild Strawberry | 2 | 3 | 6 | 36" TALL | POT |
| HMA | Hieracium 'Summer Beauty' | Summer Beauty Maidenhair | 5 | 3 | 15 | 36" TALL | POT |
| HIP | Hieracium 'Hippocrepis' | Red Flowered Maidenhair | 1 | 3 | 3 | 36" TALL | POT |
| ISM | Isopyrum 'Mistral' | White Flowered Stachys | 4 | 3 | 12 | 12" TALL | POT |
| WFE | Wormwood 'Elysium' | Wormwood | 4 | 3 | 12 | 12" TALL | POT |
| PERENNIALS | | | | | | | |
| JMG | Juniperus 'Emerald Gold' | Sea of Gold Juniper | 3 | 4 | 12 | 12" TALL | POT |
| JSB | Juniperus 'Blue Star' | Blue Star Juniper | 3 | 4 | 12 | 12" TALL | POT |
| VE | Veronica 'Bluebird' | Bluebird Veronica | 5 | 4 | 20 | 12" TALL | POT |
| RP | Rhododendron 'Purple Heart' | Purple Heart Rhododendron | 1 | 4 | 4 | 36" TALL | POT |
| TV | Thuja 'Green Gem' | Green Gem Thuja | 1 | 4 | 4 | 12" TALL | POT |
| TMT | Taxus 'Mint Green' | Mint Green Taxus | 8 | 3 | 24 | 36" TALL | POT |
| TOH | Thuja 'Hortensia Blue' | Hortensia Blue Thuja | 14 | 4 | 56 | 36" TALL | POT |
| ORNAMENTAL GRASSES | | | | | | | |
| CAK | Calamagrostis 'Karl Foerster' | Karl Foerster Feather Reed Grass | 30 | 2 | 60 | 1 GAL | POT |
| DC | Dactyloctenium 'Dorchester' | Dorchester Reed Grass | 1 | 2 | 2 | 1 GAL | POT |
| SN | Stipa 'Siberian' | Siberian Reed Grass | 4 | 2 | 8 | 1 GAL | POT |
| SH | Stipa 'Siberian Blue' | Siberian Blue Reed Grass | 13 | 2 | 26 | 1 GAL | POT |
| | | | TOTAL: | 576 | POINTS | | |

GROUND COVER LEGEND

- LAWN
- INFILTRATION AREA
- 3" DEPTH WASHED STONE MULCH OVER FILTER FABRIC

SITE LANDSCAPE PLAN - GENERAL NOTES

1. CONTACT DIGGERS' HOTLINE 3 WORKING DAYS PRIOR TO THE START OF CONSTRUCTION.
2. CONTRACTOR SHALL VERIFY THE LOCATION OF ALL THE PRIVATE UTILITIES PRIOR TO THE START OF WORK.
3. ALL LANDSCAPE BEDS SHALL CONTAIN A 3" DEPTH OF LOCAL WASHED STONE MULCH OVER LANDSCAPE FABRIC CONTAINED BY LANDSCAPE EDGING.
4. WASHED STONE MULCH SHALL BE 1.25-INCH OR LARGER.
5. LANDSCAPE EDGING SHALL BE 3/16" x 4" ALUMINUM EDGING.
6. LANDSCAPE FABRIC SHALL BE MIRAFI 140N OR APPROVED EQUAL.
7. ALL GENERAL LANDSCAPE AREAS SHALL HAVE A MINIMUM 6" COMPACTED DEPTH OF TOPSOIL.
8. LAWN AREAS SHALL BE SEEDED WITH MADISON PARKS SEED MIX AS MANUFACTURED BY LA CROSSE SEED, LLC. PER MANUFACTURER'S SPECIFICATIONS.
9. INFILTRATION AREA PLANT MIX SHALL CONFORM TO THE SPECIFICATIONS OF THE RAINWATER RENEWAL GARDEN FOR SUNNY SITES AS MANUFACTURED BY AGRECOL NATIVE NURSERY (www.agrecol.com) OR APPROVED EQUAL. SEE GRADING AND EROSION CONTROL PLAN FOR INFILTRATION BASIN PLANTING DETAIL.
10. ALL LANDSCAPING SHALL BE IN ACCORDANCE WITH THE CITY OF MADISON ZONING ORDINANCE.

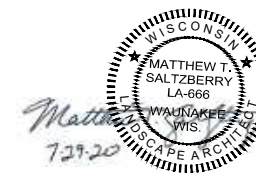

LANDSCAPE PLAN

LUCKY'S 1313 EXPANSION

CITY OF MADISON, DANE COUNTY, WISCONSIN



DATE: 07/29/2020
REVISED:

DRAWN BY: MS

FN: 20-05-130

Sheet Number:

L-1



knothe • bruce
ARCHITECTS

knothebruce.com 608.836.3690
7601 University Ave. • Suite 201 • Middleton, WI 53562

KEY PLAN

ISSUED
Issued for Land Use Submittal - July 29, 2020

PROJECT TITLE
**LUCKY'S 1313
EXPANSION**

1313 REGENT ST.
MADISON, WI

SHEET TITLE
**BASEMENT
FLOOR PLAN**

SHEET NUMBER

A-1.0

PROJECT NUMBER 1916

© Knothe & Bruce Architects, LLC

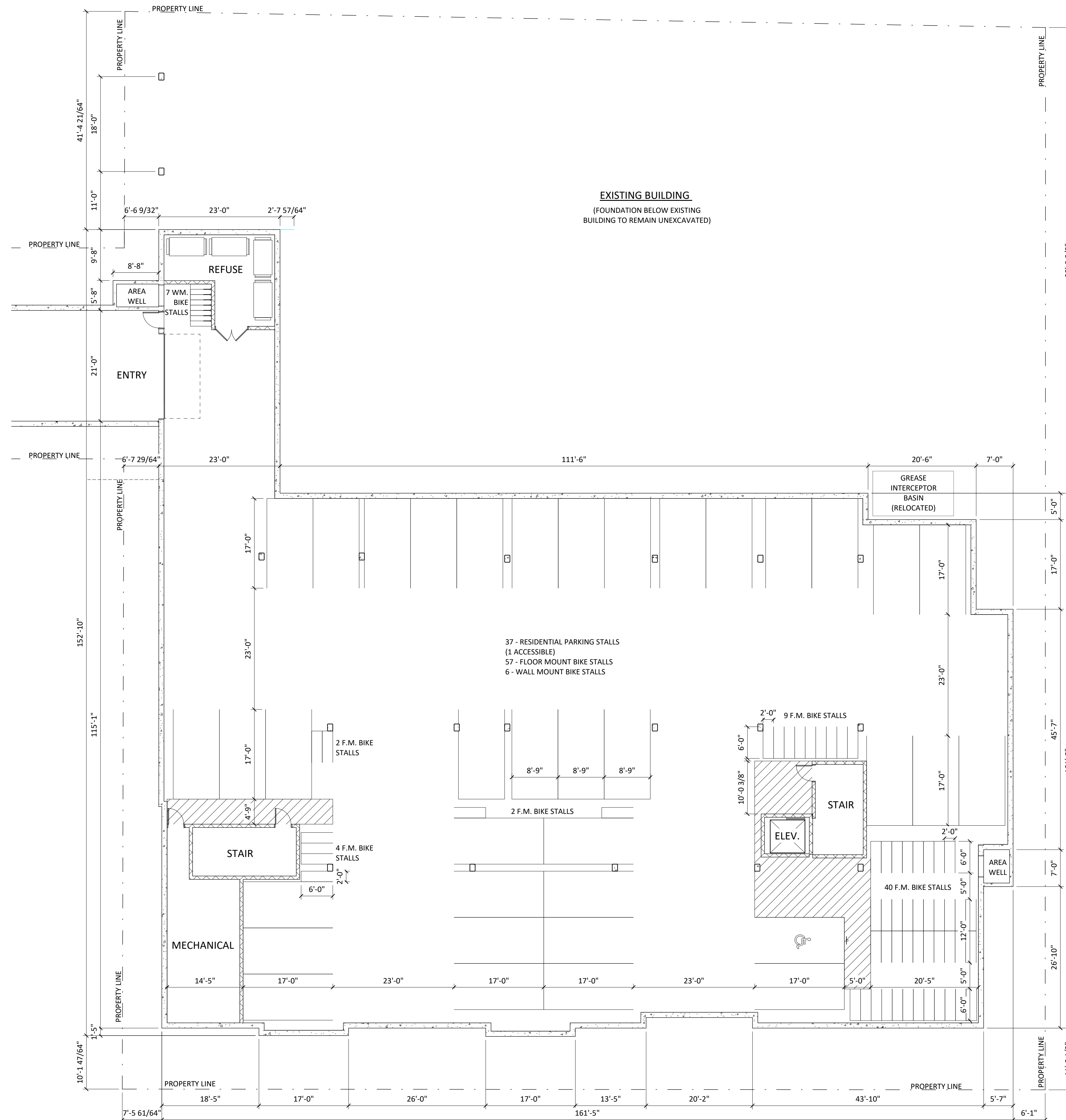

1
A-1.0
BASEMENT FLOOR PLAN
3/32" = 1'-0"

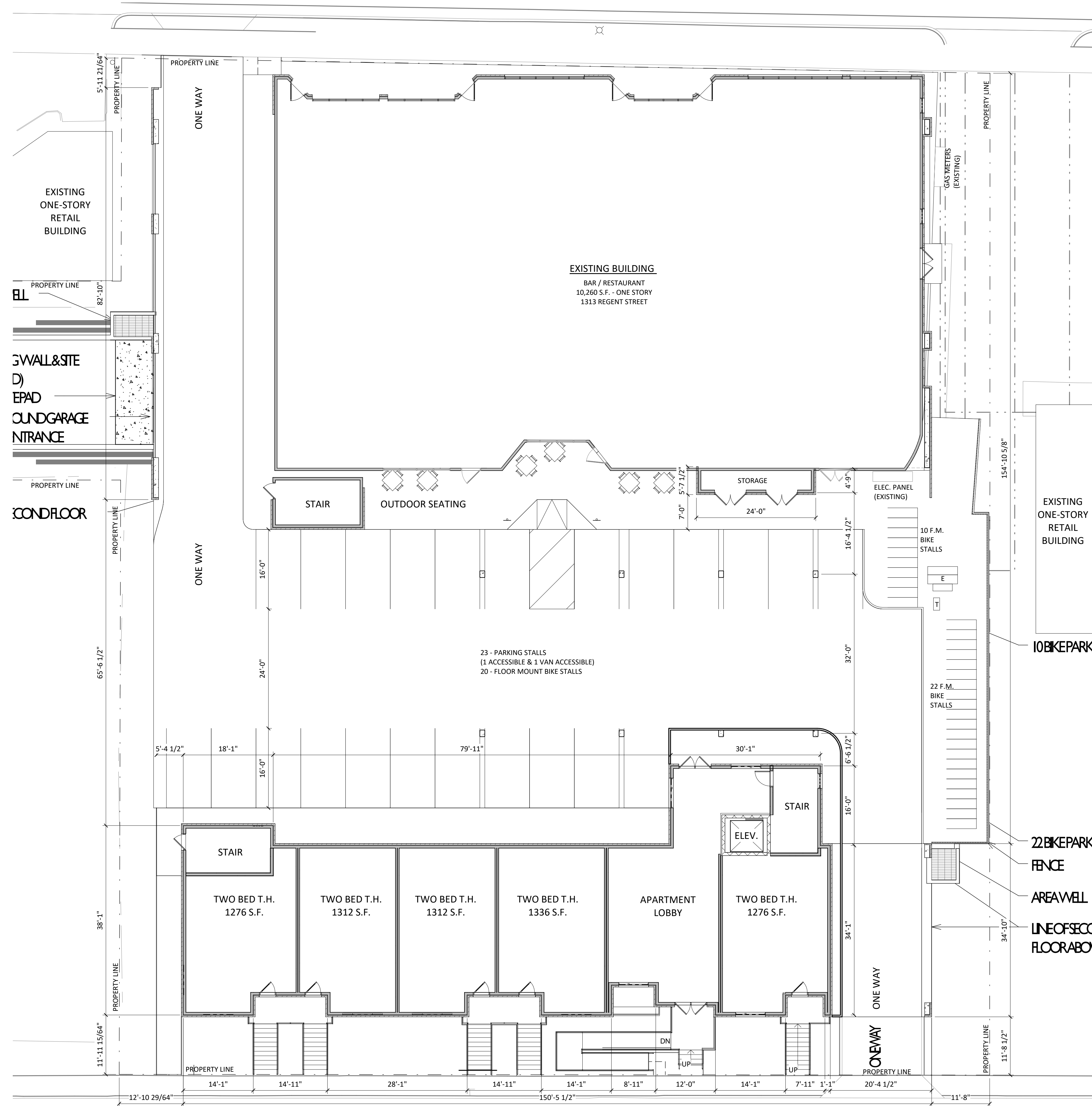

knothe • bruce
ARCHITECTS

knothebruce.com 608.836.3690
7601 University Ave. • Suite 201 • Middleton, WI 53562

KEY PLAN

ISSUED
Issued for Land Use Submittal - July 29, 2020

PROJECT TITLE
**LUCKY'S 1313
EXPANSION**

1313 REGENT ST.
MADISON, WI

SHEET TITLE
**FIRST FLOOR
PLAN**

SHEET NUMBER

A-1.1

PROJECT NUMBER 1916

© Knothe & Bruce Architects, LLC

1
A-1.1
FIRST FLOOR PLAN
3/32" = 1'-0"



knothe • bruce
ARCHITECTS

knothebruce.com 608.836.3690
7601 University Ave. • Suite 201 • Middleton, WI 53562

KEY PLAN

ISSUED
Issued for Land Use Submittal - July 29, 2020

PROJECT TITLE
**LUCKY'S 1313
EXPANSION**

1313 REGENT ST.
MADISON, WI

SHEET TITLE
**SECOND FLOOR
PLAN**

SHEET NUMBER

A-1.2

PROJECT NUMBER 1916

© Knothe & Bruce Architects, LLC

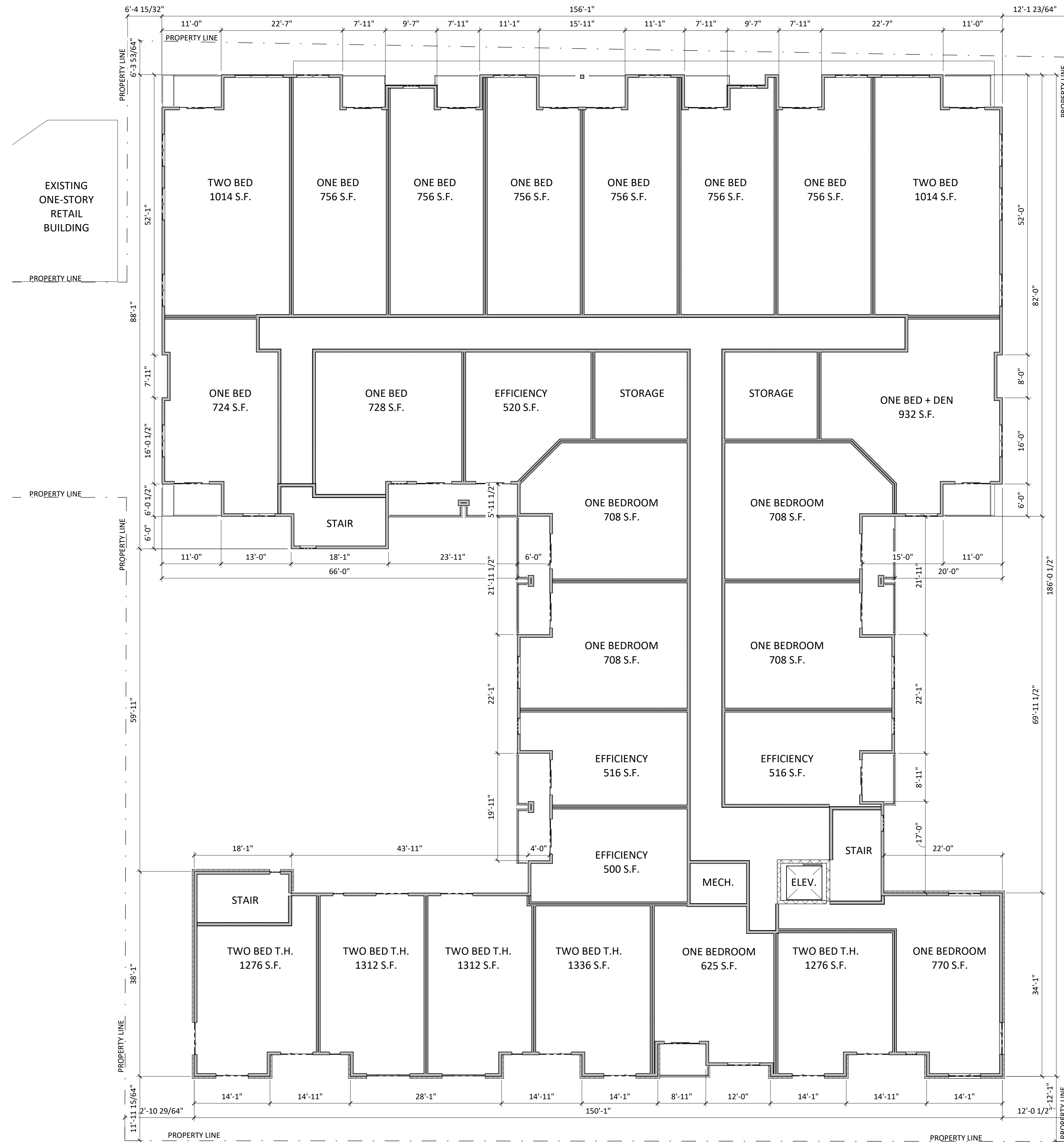

EXISTING
ONE-STORY
RETAIL
BUILDING

EXISTING
ONE-STORY
RETAIL
BUILDING



knothe • bruce
ARCHITECTS

knothebruce.com 608.836.3690
7601 University Ave. • Suite 201 • Middleton, WI 53562

KEY PLAN

ISSUED
Issued for Land Use Submittal - July 29, 2020

PROJECT TITLE
**LUCKY'S 1313
EXPANSION**

1313 REGENT ST.
MADISON, WI

SHEET TITLE
**THIRD FLOOR
PLAN**

SHEET NUMBER

A-1.3

PROJECT NUMBER 1916

© Knothe & Bruce Architects, LLC

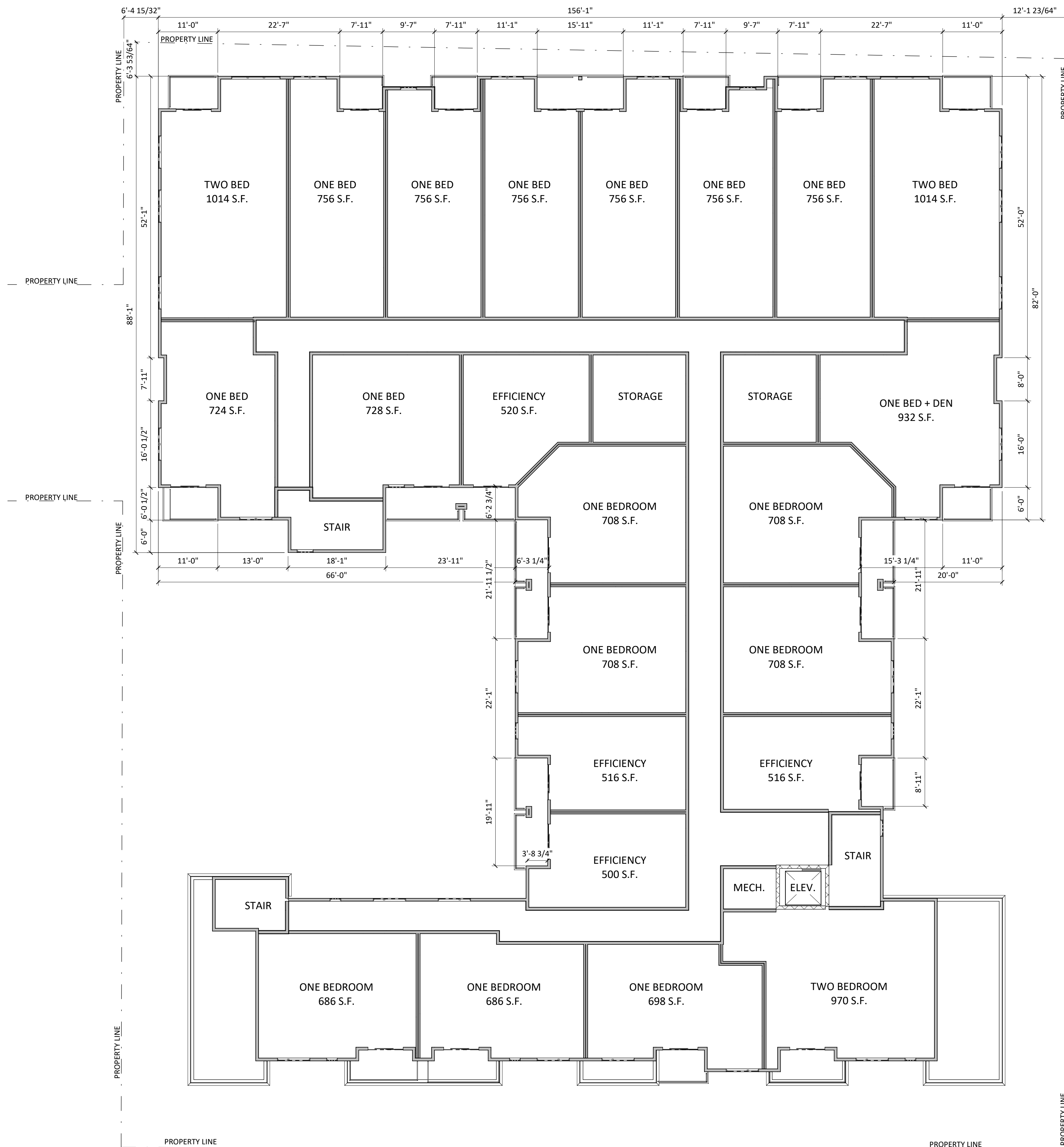



knothe + bruce
ARCHITECTS

knothebruce.com 608.836.3690
7601 University Ave. • Suite 201 • Middleton, WI 53562

KEY PLAN

ISSUED
Issued for Land Use Submittal - July 29, 2020

PROJECT TITLE
**LUCKY'S 1313
EXPANSION**

1313 REGENT ST.
MADISON, WI

SHEET TITLE
**FOURTH FLOOR
PLAN**

SHEET NUMBER

A-1.4

PROJECT NUMBER 1916

© Knothe & Bruce Architects, LLC





knothe + bruce
ARCHITECTS

knothebruce.com 608.836.3690
7601 University Ave. • Suite 201 • Middleton, WI 53562

KEY PLAN

ISSUED
Issued for Land Use Submittal - July 29, 2020

PROJECT TITLE
**LUCKY'S 1313
EXPANSION**

1313 REGENT ST.
MADISON, WI

SHEET TITLE
ROOF PLAN

SHEET NUMBER

A-1.5

PROJECT NUMBER 1916

© Knothe & Bruce Architects, LLC





1 North
A-2.1 3/32" = 1'-0"



2 West
A-2.1 3/32" = 1'-0"

| EXTERIOR MATERIAL SCHEDULE | | |
|---------------------------------|---------------|-------------------------|
| BUILDING ELEMENT | MANUFACTURER | COLOR |
| MINI RIB - METAL PANEL - (#1) | MCELROY METAL | SLATE GRAY |
| MEGA RIB - METAL PANEL - (#2) | MCELROY METAL | COLONIAL RED |
| MINI RIB - METAL PANEL - (#3-M) | MCELROY METAL | ASH GRAY |
| COMPOSITE PANEL SIDING - (#3-P) | JAMES HARDIE | PEARL GRAY |
| METAL TRIM - (#T1) | JAMES HARDIE | SLATE GRAY |
| METAL TRIM - (#T2) | JAMES HARDIE | COLONIAL RED |
| COMPOSITE TRIM - (#T3) | JAMES HARDIE | PEARL GRAY |
| MODULAR BRICK VENEER | N/A | MATCH EXISTING |
| COMPOSITE WINDOWS | TBD | BLACK |
| ALUM. STOREFRONT | N/A | BLACK FRAME / RED DOORS |
| METAL DOORS/FRAMES | N/A | BLACK |
| STONE SILLS & BANDS | EDWARDS | 18-031 |
| SOFFITS | N/A | CITY SCAPE |
| RAILINGS | SUPERIOR | BLACK |



1 South
A-2.2 3/32" = 1'-0"

ISSUED
Issued for Land Use Submittal - July 27, 2020



2 East
A-2.2 3/32" = 1'-0"

PROJECT TITLE
LUCKY'S 1313
EXPANSION

1313 REGENT ST.
MADISON, WI

SHEET TITLE
EXTERIOR
ELEVATIONS

SHEET NUMBER

A-2.2

PROJECT NUMBER 1916

© Knothe & Bruce Architects, LLC

| EXTERIOR MATERIAL SCHEDULE | | |
|---------------------------------|---------------|-------------------------|
| BUILDING ELEMENT | MANUFACTURER | COLOR |
| MINI RIB - METAL PANEL - (#1) | MCELROY METAL | SLATE GRAY |
| MEGA RIB - METAL PANEL - (#2) | MCELROY METAL | COLONIAL RED |
| MINI RIB - METAL PANEL - (#3-M) | MCELROY METAL | ASH GRAY |
| COMPOSITE PANEL SIDING - (#3-P) | JAMES HARDIE | PEARL GRAY |
| METAL TRIM - (#T1) | JAMES HARDIE | SLATE GRAY |
| METAL TRIM - (#T2) | JAMES HARDIE | COLONIAL RED |
| COMPOSITE TRIM - (#T3) | JAMES HARDIE | PEARL GRAY |
| MODULAR BRICK VENEER | N/A | MATCH EXISTING |
| COMPOSITE WINDOWS | TBD | BLACK |
| ALUM. STOREFRONT | N/A | BLACK FRAME / RED DOORS |
| METAL DOORS/FRAMES | N/A | BLACK |
| STONE SILLS & BANDS | EDWARDS | 18-031 |
| SOFFITS | N/A | CITY SCAPE |
| RAILINGS | SUPERIOR | BLACK |

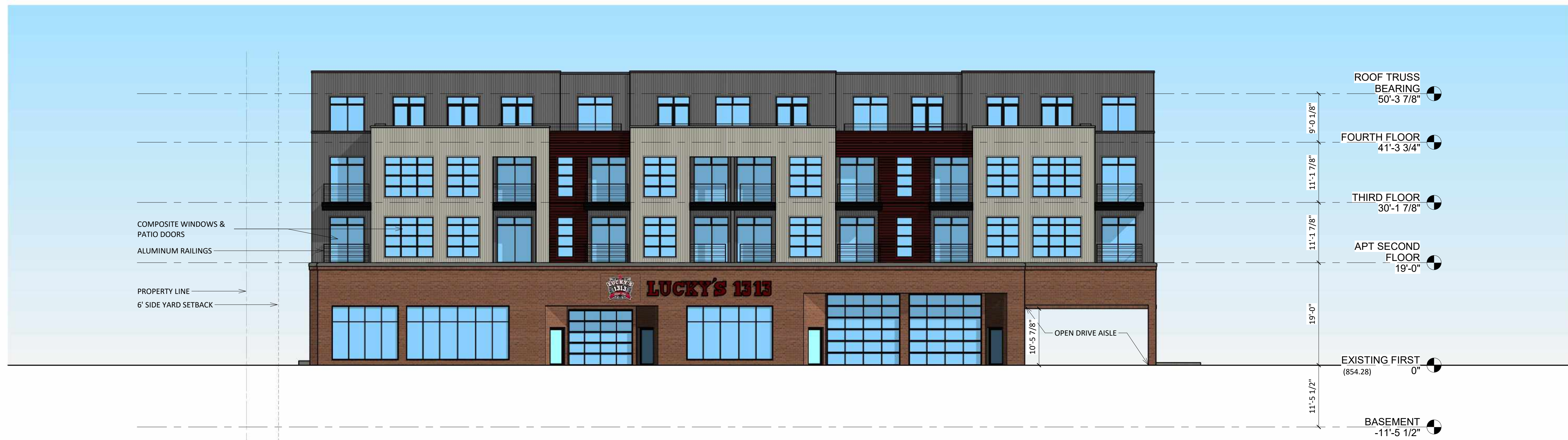

1 North - Rendered Elevation
A-2.3 3/32" = 1'-0"

ISSUED
Issued for Land Use Submittal - July 27, 2020



2 West - Rendered Elevation
A-2.3 3/32" = 1'-0"

PROJECT TITLE
**LUCKY'S 1313
EXPANSION**

1313 REGENT ST.
MADISON, WI

SHEET TITLE
**RENDERED
EXTERIOR
ELEVATIONS**

SHEET NUMBER

A-2.3

PROJECT NUMBER 1916

© Knothe & Bruce Architects, LLC

| EXTERIOR MATERIAL SCHEDULE | | |
|---------------------------------|---------------|-------------------------|
| BUILDING ELEMENT | MANUFACTURER | COLOR |
| MINI RIB - METAL PANEL - (#1) | MCELROY METAL | SLATE GRAY |
| MEGA RIB - METAL PANEL - (#2) | MCELROY METAL | COLONIAL RED |
| MINI RIB - METAL PANEL - (#3-M) | MCELROY METAL | ASH GRAY |
| COMPOSITE PANEL SIDING - (#3-P) | JAMES HARDIE | PEARL GRAY |
| METAL TRIM - (#T1) | JAMES HARDIE | SLATE GRAY |
| METAL TRIM - (#T2) | JAMES HARDIE | COLONIAL RED |
| COMPOSITE TRIM - (#T3) | JAMES HARDIE | PEARL GRAY |
| MODULAR BRICK VENEER | N/A | MATCH EXISTING |
| COMPOSITE WINDOWS | TBD | BLACK |
| ALUM. STOREFRONT | N/A | BLACK FRAME / RED DOORS |
| METAL DOORS/FRAMES | N/A | BLACK |
| STONE SILLS & BANDS | EDWARDS | 18-031 |
| SOFFITS | N/A | CITY SCAPE |
| RAILINGS | SUPERIOR | BLACK |



1 South - Rendered Elevation
A-2.4 3/32" = 1'-0"

ISSUED
Issued for Land Use Submittal - July 27, 2020



2 East - Rendered Elevation
A-2.4 3/32" = 1'-0"

PROJECT TITLE
**LUCKY'S 1313
EXPANSION**

1313 REGENT ST.
MADISON, WI

SHEET TITLE
**RENDERED
EXTERIOR
ELEVATIONS**

SHEET NUMBER

A-2.4

PROJECT NUMBER 1916

© Knothe & Bruce Architects, LLC

| EXTERIOR MATERIAL SCHEDULE | | |
|---------------------------------|---------------|-------------------------|
| BUILDING ELEMENT | MANUFACTURER | COLOR |
| MINI RIB - METAL PANEL - (#1) | MCELROY METAL | SLATE GRAY |
| MEGA RIB - METAL PANEL - (#2) | MCELROY METAL | COLONIAL RED |
| MINI RIB - METAL PANEL - (#3-M) | MCELROY METAL | ASH GRAY |
| COMPOSITE PANEL SIDING - (#3-P) | JAMES HARDIE | PEARL GRAY |
| METAL TRIM - (#T1) | JAMES HARDIE | SLATE GRAY |
| METAL TRIM - (#T2) | JAMES HARDIE | COLONIAL RED |
| COMPOSITE TRIM - (#T3) | JAMES HARDIE | PEARL GRAY |
| MODULAR BRICK VENEER | N/A | MATCH EXISTING |
| COMPOSITE WINDOWS | TBD | BLACK |
| ALUM. STOREFRONT | N/A | BLACK FRAME / RED DOORS |
| METAL DOORS/FRAMES | N/A | BLACK |
| STONE SILLS & BANDS | EDWARDS | 18-031 |
| SOFFITS | N/A | CITY SCAPE |
| RAILINGS | SUPERIOR | BLACK |



Existing Building along Regent Street

LUCKY'S EXPANSION
1313 REGENT STREET
MADISON, WI
OCTOBER 5, 2020





Existing Building along Bowen Court

LUCKY'S EXPANSION
1313 REGENT STREET
MADISON, WI
OCTOBER 5, 2020





 **LUCKY'S 1313**

LUCKY'S
1313 REGENT ST. MADISON, WI
RENDERED PERSPECTIVE
OCTOBER 14, 2020





LUCKY'S
1313 REGENT ST. MADISON, WI
RENDERED PERSPECTIVE
OCTOBER 14, 2020





LUCKY'S
1313 REGENT ST. MADISON, WI
RENDERED PERSPECTIVE
OCTOBER 14, 2020





LUCKY'S
1313 REGENT ST. MADISON, WI
RENDERED PERSPECTIVE
OCTOBER 14, 2020





EDWARDS
18-031

STONE SILLS & BANDS



ENTRY DOORS



**ALUMINUM RAILINGS
STOREFRONT FRAME
& WINDOWS**



MCELROY METAL
SLATE GRAY

#1

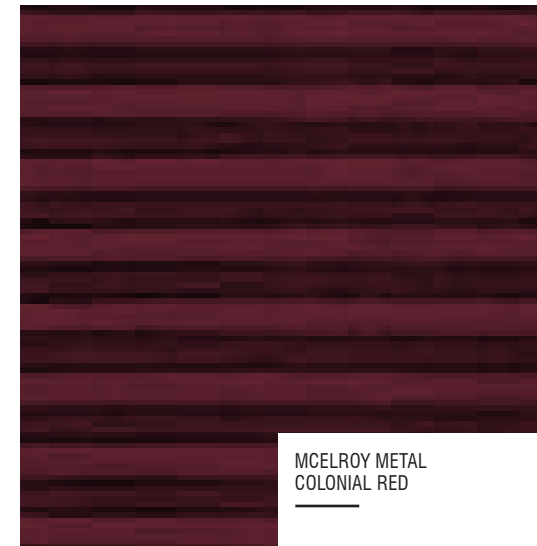

MCELROY METAL
COLONIAL RED

#2

METAL SIDING & TRIM



MCELROY METAL
ASH GRAY

#3



CLOUD CERAMICS
DRIFTWOOD GREY

BRICK VENEER

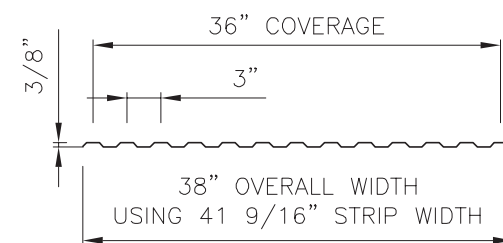

MINI-RIB PROFILE



MEGA-RIB PROFILE

MATERIALS
LUCKY'S EXPANSION
1313 REGENT STREET
MADISON, WI
OCTOBER 21, 2020





1 North - Rendered Elevation
A-2.3 3/32" = 1'-0"

ISSUED
Issued for Land Use Submittal - July 27, 2020



2 West - Rendered Elevation
A-2.3 3/32" = 1'-0"

PROJECT TITLE
**LUCKY'S 1313
EXPANSION**

Previous Design

| EXTERIOR MATERIAL SCHEDULE | | |
|---|--------------|--------------------------|
| BUILDING ELEMENT | MANUFACTURER | COLOR |
| COMPOSITE LAP SIDING - (#1) - 4" | JAMES HARDIE | SLATE GRAY |
| COMPOSITE PANEL SIDING - (#2) | JAMES HARDIE | SW 7585 SUN DRIED TOMATO |
| COMPOSITE LAP SIDING - (#3-S) - ALT WIDTH | JAMES HARDIE | PEARL GRAY |
| COMPOSITE PANEL SIDING - (#3-P) | JAMES HARDIE | PEARL GRAY |
| COMPOSITE TRIM - (#T1) | JAMES HARDIE | SLATE GRAY |
| COMPOSITE TRIM - (#T2) | JAMES HARDIE | SW 7585 SUN DRIED TOMATO |
| COMPOSITE TRIM - (#T3) | JAMES HARDIE | PEARL GRAY |
| MODULAR BRICK VENEER | N/A | MATCH EXISTING |
| COMPOSITE WINDOWS | TBD | BLACK |
| ALUM. STOREFRONT | N/A | BLACK FRAME / RED DOORS |
| METAL DOORS/FRAMES | N/A | BLACK |
| STONE SILLS & BANDS | EDWARDS | 18-031 |
| SOFFITS | N/A | CITY SCAPE |
| RAILINGS | SUPERIOR | BLACK |

1313 REGENT ST.
MADISON, WI

SHEET TITLE
**RENDERED
EXTERIOR
ELEVATIONS**

SHEET NUMBER

A-2.3

PROJECT NUMBER 1916

© Knothe & Bruce Architects, LLC



1 South - Rendered Elevation
A-2.4 3/32" = 1'-0"



2 East - Rendered Elevation
A-2.4 3/32" = 1'-0"

Previous Design

| EXTERIOR MATERIAL SCHEDULE | | |
|---|--------------|--------------------------|
| BUILDING ELEMENT | MANUFACTURER | COLOR |
| COMPOSITE LAP SIDING - (#1) - 4" | JAMES HARDIE | SLATE GRAY |
| COMPOSITE PANEL SIDING - (#2) | JAMES HARDIE | SW 7585 SUN DRIED TOMATO |
| COMPOSITE LAP SIDING - (#3-S) - ALT WIDTH | JAMES HARDIE | PEARL GRAY |
| COMPOSITE PANEL SIDING - (#3-P) | JAMES HARDIE | PEARL GRAY |
| COMPOSITE TRIM - (#T1) | JAMES HARDIE | SLATE GRAY |
| COMPOSITE TRIM - (#T2) | JAMES HARDIE | SW 7585 SUN DRIED TOMATO |
| COMPOSITE TRIM - (#T3) | JAMES HARDIE | PEARL GRAY |
| MODULAR BRICK VENEER | N/A | MATCH EXISTING |
| COMPOSITE WINDOWS | TBD | BLACK |
| ALUM. STOREFRONT | N/A | BLACK FRAME / RED DOORS |
| METAL DOORS/FRAMES | N/A | BLACK |
| STONE SILLS & BANDS | EDWARDS | 18-031 |
| SOFFITS | N/A | CITY SCAPE |
| RAILINGS | SUPERIOR | BLACK |

Previous Design



LUCKY'S
1313 REGENT ST. MADISON, WI
RENDERED PERSPECTIVE
OCTOBER 05, 2020



Previous Design



LUCKY'S
1313 REGENT ST. MADISON, WI
RENDERED PERSPECTIVE
OCTOBER 05, 2020



Previous Design



LUCKY'S
1313 REGENT ST. MADISON, WI
RENDERED PERSPECTIVE
OCTOBER 05, 2020



Previous Design



LUCKY'S
1313 REGENT ST. MADISON, WI
RENDERED PERSPECTIVE
OCTOBER 05, 2020

