

3040 / 3046 COMMERCIAL AVENUE EXTERIOR LUMINAIRE SCHEDULE

QTY	TYPE	DESCRIPTION	CCT	NOMINAL DELIVERED LUMENS	NOMINAL WATTAGE	MFTR	MODEL #
2	P1	POLE MOUNTED AREA LIGHT. FULL CUTOFF TYPE 4 MEDIUM DISTRIBUTION WITH HOUSE SIDE SHIELD. PROVIDE WITH 25' ROUND STRAIGHT STEEL POLE. VERIFY FINISH SELECTION.	3000	10,217	125	LITHONIA	DSX1-LED-P4-30K-T4M-MVOLT-HS
3	P2	POLE MOUNTED PEDESTRIAN LIGHT. FULL CUTOFF TYPE 4 MEDIUM DISTRIBUTION WITH HOUSE SIDE SHIELD. PROVIDE WITH 14' ROUND STRAIGHT STEEL POLE. VERIFY FINISH SELECTION.	3000	3,322	38	LITHONIA	DSX0-LED-P1-30K-T4M-MVOLT-HS
7	P3	POLE MOUNTED PEDESTRIAN LIGHT. FULL CUTOFF TYPE 3 WITH BACKLIGHT CONTROL. PROVIDE WITH 14' ROUND STRAIGHT STEEL POLE. VERIFY FINISH SELECTION.	3000	3,585	38	LITHONIA	DSX0-LED-P1-30K-BLC-MVOLT
11	W1	FULL CUTOFF FORWARD THROW AREA LIGHT. MOUNT AT APPROXIMATELY 9'-0" AFG. VERIFY FINISH SELECTION.	3000	1,161	10	LITHONIA	WDGE1-LED-P1-30K-80CRI-VF
28	W2	UNIT PATIO SCONCE. VERIFY FINISH SELECTION. MOUNT AT APPROXIMATELY 7' ABOVE FINISHED FLOOR.	3000	1,293	13	ACCESS	EDGE 20050LEDDMG-XXX



D-Series Size 1 LED Area Luminaire

d#series



Catalog Number	
Notes	
Type	P1

Hit the Tab key or mouse over the page to see all interactive elements.

Specifications

EPA:	1.01 ft ² (0.09 m ²)
Length:	33" (83.8 cm)
Width:	13" (33.0 cm)
Height H1:	7-1/2" (19.0 cm)
Height H2:	3-1/2"
Weight (max):	27 lbs (12.2 kg)

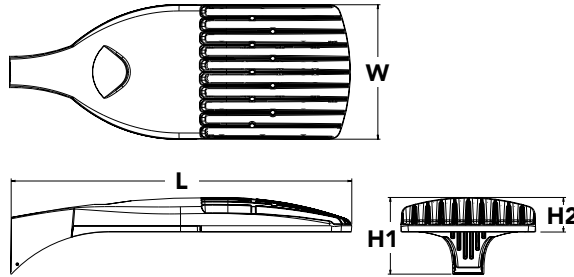

Introduction

The modern styling of the D-Series is striking yet unobtrusive - making a bold, progressive statement even as it blends seamlessly with its environment. The D-Series distills the benefits of the latest in LED technology into a high performance, high efficacy, long-life luminaire.

The outstanding photometric performance results in sites with excellent uniformity, greater pole spacing and lower power density. It is ideal for replacing up to 750W metal halide in pedestrian and area lighting applications with typical energy savings of 65% and expected service life of over 100,000 hours.

A+ Capable options indicated by this color background.

Ordering Information

EXAMPLE: DSX1 LED P7 40K T3M MVOLT SPA NLTAIR2 PIRHN DDBXD

DSX1 LED		Color temperature		Distribution		Voltage	Mounting		
Series	LEDs								
DSX1 LED	Forward optics	30K	3000 K	T1S	Type I short (Automotive)	T5VS	Type V very short ²	MVOLT ⁴	Shipped included SPA Square pole mounting RPA Round pole mounting WBA Wall bracket ² SPUMBA Square pole universal mounting adaptor ⁶ RPUMBA Round pole universal mounting adaptor ⁶ Shipped separately KMA8 DDBXD U Mast arm mounting bracket adaptor (specify finish) ⁷
	P1 P4 P7	40K	4000 K	T2S	Type II short	T5S	Type V short ²	120 ⁵	
	P2 P5 P8	50K	5000 K	T2M	Type II medium	T5M	Type V medium ²	208 ⁵	
	P3 P6 P9			T3S	Type III short	T5W	Type V wide ²	240 ⁵	
	Rotated optics			T3M	Type III medium	BLC	Backlight control ³	277 ⁵	
	P10 ¹ P12 ¹			T4M	Type IV medium	LCCO	Left corner cutoff ³	347 ⁵	
	P11 ¹ P13 ¹			TFTM	Forward throw medium	RCCO	Right corner cutoff ³	480 ⁵	

Control options	Other options	Finish (required)
Shipped installed NLTAIR2 nLight AIR generation 2 enabled ⁸ PIRHN Network, high/low motion/ambient sensor ⁹ PER NEMA twist-lock receptacle only (controls ordered separate) ¹⁰ PER5 Five-pin receptacle only (controls ordered separate) ^{10,11} PER7 Seven-pin receptacle only (controls ordered separate) ^{10,11} DMG 0-10v dimming wires pulled outside fixture (for use with an external control, ordered separately) ¹³ DS Dual switching ^{13,14,15}	PIR High/low, motion/ambient sensor, 8-15' mounting height, ambient sensor enabled at 5fc ^{16,17} PIRH High/low, motion/ambient sensor, 15-30' mounting height, ambient sensor enabled at 5fc ^{16,17} PIR1FC3V High/low, motion/ambient sensor, 8-15' mounting height, ambient sensor enabled at 1fc ^{16,17} PIRH1FC3V Bi-level, motion/ambient sensor, 15-30' mounting height, ambient sensor enabled at 1fc ^{16,17} FAO Field adjustable output ¹⁵	Shipped installed HS House-side shield ¹⁸ SF Single fuse (120, 277, 347V) ⁵ DF Double fuse (208, 240, 480V) ⁵ L90 Left rotated optics ¹ R90 Right rotated optics ¹ Shipped separately BS Bird spikes ¹⁹ EGS External glare shield
		DDBXD Dark bronze DBLXD Black DNAXD Natural aluminum DWHXD White DDBTXD Textured dark bronze DBLBXD Textured black DNATXD Textured natural aluminum DWHGXD Textured white



Ordering Information

Accessories

Ordered and shipped separately.

DLL127F 1.5 JU	Photocell - SSL twist-lock (120-277V) ²⁰
DLL347F 1.5 CUL JU	Photocell - SSL twist-lock (347V) ²⁰
DLL480F 1.5 CUL JU	Photocell - SSL twist-lock (480V) ²⁰
DSHORT SBK U	Shorting cap ²⁰
DSX1HS 30C U	House-side shield for P1, P2, P3, P4 and P5 ¹⁸
DSX1HS 40C U	House-side shield for P6 and P7 ¹⁸
DSX1HS 60C U	House-side shield for P8, P9, P10, P11 and P12 ¹⁸
PUMBA DDBXD U*	Square and round pole universal mounting bracket (specify finish) ²¹
KMA8 DDBXD U	Mast arm mounting bracket adaptor (specify finish) ⁷
DSX1EGS (FINISH) U	External glare shield

For more control options, visit [DTL](#) and [ROAM](#) online.

NOTES

- P10, P11, P12 or P13 and rotated optics (L90, R90) only available together.
- Any Type 5 distribution with photocell, is not available with WBA.
- Not available with HS.
- MVOLT driver operates on any line voltage from 120-277V (50/60 Hz).
- Single fuse (SF) requires 120V, 277V or 347V. Double fuse (DF) requires 208V, 240V or 480V.
- Universal mounting brackets intended for retrofit on existing, pre-drilled poles only. 1.5 G vibration load rating per ANCI C136.31.
- Must order fixture with SPA option. Must be ordered as a separate accessory; see Accessories information. For use with 2-3/8" mast arm (not included).
- Must be ordered with PIRHN. Sensor cover available only in dark bronze, black, white and natural aluminum colors.
- Must be ordered with NLTAIR2. For more information on Light Air 2 visit [this link](#).
- Photocell ordered and shipped as a separate line item from Acuity Brands Controls. See accessories. Not available with DS option. Shorting cap included.
- If ROAM[®] node required, it must be ordered and shipped as a separate line item from Acuity Brands Controls. Node with integral dimming.
- DMG not available with PIRHN, PER5, PER7, PIR, PIRH, PIR1FC3V or PIRH1FC3V.
- Provides 50/50 fixture operation via (2) independent drivers. Not available with PER, PER5, PER7, PIR or PIRH. Not available P1, P2, P3, P4 or P5.
- Requires (2) separately switched circuits with isolated neutral. See Outdoor Control Technical Guide for details.
- Reference Motion Sensor table on page 4.
- Reference controls options table on page 4 to see functionality.
- Not available with other dimming controls options
- Not available with BLC, LCCO and RCCO distribution. Also available as a separate accessory; see Accessories information.
- Must be ordered with fixture for factory pre-drilling.
- Requires luminaire to be specified with PER, PER5 or PER7 option. See PER Table on page 3.
- For retrofit use only.

Options

EGS - External Glare Shield

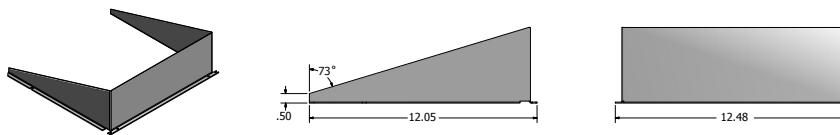

Drilling

HANDHOLE ORIENTATION

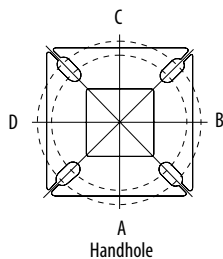

Tenon Mounting Slipfitter**

Tenon O.D.	Mounting	Single Unit	2 @ 180	2 @ 90	3 @ 120	3 @ 90	4 @ 90
2-3/8"	SPA/RPA	AS3-5 190	AS3-5 280	AS3-5 290	AS3-5 320	AS3-5 390	AS3-5 490
	SPUMBA	AS3-5 190	AS3-5 280	AS4-5 290	AS3-5 320	AS4-5 390	AS4-5 490
	RUPUMBA	AS3-5 190	AS3-5 280		AS3-5 320		
2-7/8"	SPA/RPA	AST25-190	AST25-280	AST25-290	AST25-320	AST25-390	AST25-490
	SPUMBA	AST25-190	AST25-280		AST25-320		
	RUPUMBA	AST25-190	AST25-280		AST25-320		
4"	SPA/RPA	AST35-190	AST35-280	AST35-290	AST35-320	AST35-390	AST35-490
	SPUMBA	AST35-190	AST35-280	AST35-290	AST35-320	AST35-390	AST35-490
	RUPUMBA	AST35-190	AST35-280		AST35-320		

Template #8

Top of Pole

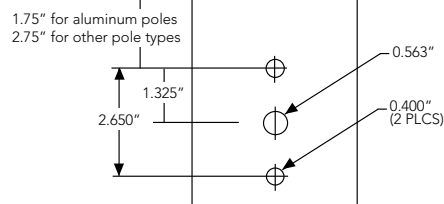

Mounting Option	Drilling Template	Single	2 @ 180	2 @ 90	3 @ 90	3 @ 120	4 @ 90
Head Location		Side B	Side B & D	Side B & C	Side B, C & D	Round Pole Only	Side A, B, C & D
Drill Nomenclature	#8	DM19AS	DM28AS	DM29AS	DM39AS	DM32AS	DM49AS

	Drilling Template	Minimum Acceptable Outside Pole Dimension					
SPA	#8	2-7/8"	2-7/8"	3.5"	3.5"	3"	3.5"
RPA	#8	2-7/8"	2-7/8"	3.5"	3.5"	3"	3.5"
SPUMBA	#5	2-7/8"	3"	4"	4"	3.5"	4"
RUPUMBA	#5	2-7/8"	3.5"	5"	5"	3.5"	5"

Photometric Diagrams

To see complete photometric reports or download .ies files for this product, visit Lithonia Lighting's [D-Series Area Size 1 homepage](#).

Isofootcandle plots for the DSX1 LED 60C 1000 40K. Distances are in units of mounting height (25').

LEGEND

- 0.1 fc
- 0.5 fc
- 1.0 fc

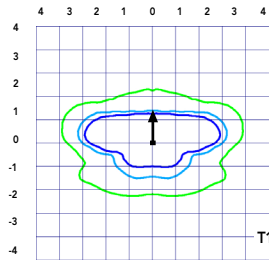

Test No. LT.L23211 tested in accordance with IESNA LM-79-08.

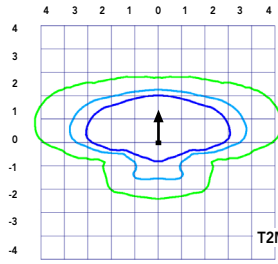

Test No. LT.L23164B tested in accordance with IESNA LM-79-08.

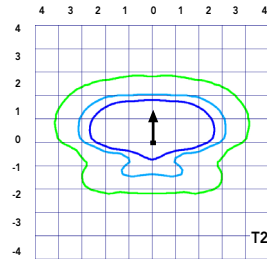

Test No. LT.L23222 tested in accordance with IESNA LM-79-08.

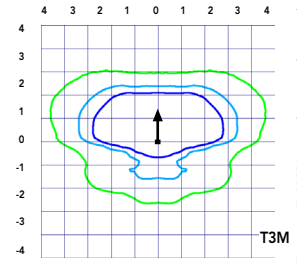

Test No. LT.L23271 tested in accordance with IESNA LM-79-08.

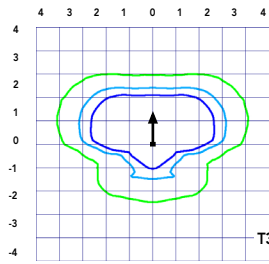

Test No. LT.L23211 tested in accordance with IESNA LM-79-08.

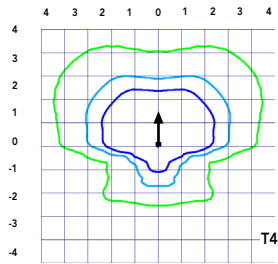

Test No. LT.L23164B tested in accordance with IESNA LM-79-08.

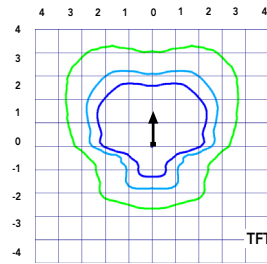

Test No. LT.L23222 tested in accordance with IESNA LM-79-08.

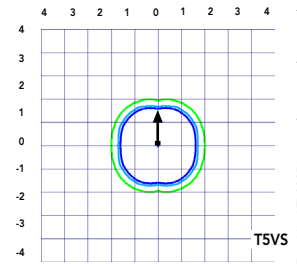

Test No. LT.L23271 tested in accordance with IESNA LM-79-08.

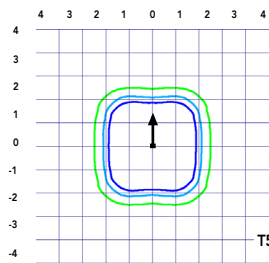

Test No. LT.L23211 tested in accordance with IESNA LM-79-08.

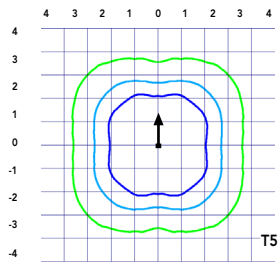

Test No. LT.L23164B tested in accordance with IESNA LM-79-08.

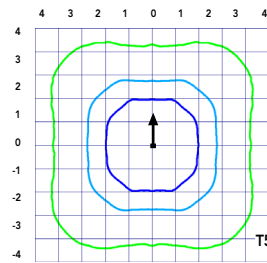

Test No. LT.L23222 tested in accordance with IESNA LM-79-08.

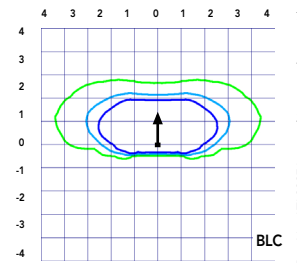

Test No. LT.L23271 tested in accordance with IESNA LM-79-08.

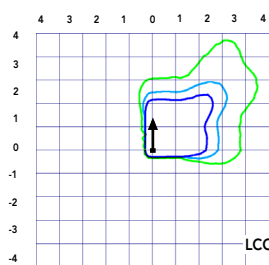

Test No. LT.L23211 tested in accordance with IESNA LM-79-08.

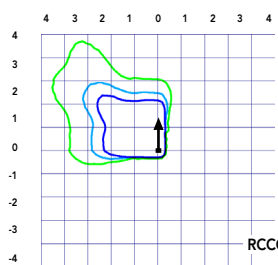

Test No. LT.L23164B tested in accordance with IESNA LM-79-08.

Performance Data

Lumen Ambient Temperature (LAT) Multipliers

Use these factors to determine relative lumen output for average ambient temperatures from 0-40°C (32-104°F).

Ambient		Lumen Multiplier
0°C	32°F	1.04
5°C	41°F	1.04
10°C	50°F	1.03
15°C	59°F	1.02
20°C	68°F	1.01
25°C	77°F	1.00
30°C	86°F	0.99
35°C	95°F	0.98
40°C	104°F	0.97

Projected LED Lumen Maintenance

Data references the extrapolated performance projections for the platforms noted in a **25°C ambient**, based on 10,000 hours of LED testing (tested per IESNA LM-80-08 and projected per IESNA TM-21-11).

To calculate LLF, use the lumen maintenance factor that corresponds to the desired number of operating hours below. For other lumen maintenance values, contact factory.

Operating Hours	Lumen Maintenance Factor
0	1.00
25,000	0.96
50,000	0.92
100,000	0.85

Motion Sensor Default Settings

Option	Dimmed State	High Level (when triggered)	Photocell Operation	Dwell Time	Ramp-up Time	Ramp-down Time
PIR or PIRH	3V (37%) Output	10V (100%) Output	Enabled @ 5FC	5 min	3 sec	5 min
*PIR1FC3V or PIRH1FC3V	3V (37%) Output	10V (100%) Output	Enabled @ 1FC	5 min	3 sec	5 min

*for use when motion sensor is used as dusk to dawn control.

Electrical Load

	Performance Package	LED Count	Drive Current	Wattage	Current (A)					
					120	208	240	277	347	480
Forward Optics (Non-Rotated)	P1	30	530	54	0.45	0.26	0.23	0.19	0.10	0.12
	P2	30	700	70	0.59	0.34	0.30	0.25	0.20	0.16
	P3	30	1050	102	0.86	0.50	0.44	0.38	0.30	0.22
	P4	30	1250	125	1.06	0.60	0.52	0.46	0.37	0.27
	P5	30	1400	138	1.16	0.67	0.58	0.51	0.40	0.29
	P6	40	1250	163	1.36	0.78	0.68	0.59	0.47	0.34
	P7	40	1400	183	1.53	0.88	0.76	0.66	0.53	0.38
	P8	60	1050	207	1.74	0.98	0.87	0.76	0.64	0.49
	P9	60	1250	241	2.01	1.16	1.01	0.89	0.70	0.51
Rotated Optics (Requires L90 or R90)	P10	60	530	106	0.90	0.52	0.47	0.43	0.33	0.27
	P11	60	700	137	1.15	0.67	0.60	0.53	0.42	0.32
	P12	60	1050	207	1.74	0.99	0.87	0.76	0.60	0.46
	P13	60	1250	231	1.93	1.12	0.97	0.86	0.67	0.49

Controls Options

Nomenclature	Description	Functionality	Primary control device	Notes
FA0	Field adjustable output device installed inside the luminaire; wired to the driver dimming leads.	Allows the luminaire to be manually dimmed, effectively trimming the light output.	FA0 device	Cannot be used with other controls options that need the 0-10V leads
DS	Drivers wired independently for 50/50 luminaire operation	The luminaire is wired to two separate circuits, allowing for 50/50 operation.	Independently wired drivers	Requires two separately switched circuits. Consider nLight AIR as a more cost effective alternative.
PERS or PER7	Twist-lock photocell receptacle	Compatible with standard twist-lock photocells for dusk to dawn operation, or advanced control nodes that provide 0-10V dimming signals.	Twist-lock photocells such as DLL Elite or advanced control nodes such as ROAM.	Pins 4 & 5 to dimming leads on driver, Pins 6 & 7 are capped inside luminaire
PIR or PIRH	Motion sensors with integral photocell. PIR for 8-15' mounting; PIRH for 15-30' mounting	Luminaires dim when no occupancy is detected.	Acuity Controls SBGR	Also available with PIRH1FC3V when the sensor photocell is used for dusk-to-dawn operation.
NLTAIR2 PIRHN	nLight AIR enabled luminaire for motion sensing, photocell and wireless communication.	Motion and ambient light sensing with group response. Scheduled dimming with motion sensor over-ride when wirelessly connected to the nLight Eclipse.	nLight Air rSDGR	nLight AIR sensors can be programmed and commissioned from the ground using the CIAIRity Pro app.

Performance Data

Lumen Output

Lumen values are from photometric tests performed in accordance with IESNA LM-79-08. Data is considered to be representative of the configurations shown, within the tolerances allowed by Lighting Facts. Contact factory for performance data on any configurations not shown here.

Rotated Optics																							
LED Count	Drive Current	Power Package	System Watts	Dist. Type	30K (3000 K, 70 CRI)					40K (4000 K, 70 CRI)					50K (5000 K, 70 CRI)								
					Lumens	B	U	G	LPW	Lumens	B	U	G	LPW	Lumens	B	U	G	LPW				
60	530	P10	106W	T1S	13,042	3	0	3	123	14,050	3	0	3	133	14,228	3	0	3	134				
				T2S	12,967	4	0	4	122	13,969	4	0	4	132	14,146	4	0	4	133				
				T2M	13,201	3	0	3	125	14,221	3	0	3	134	14,401	3	0	3	136				
				T3S	12,766	4	0	4	120	13,752	4	0	4	130	13,926	4	0	4	131				
				T3M	13,193	4	0	4	124	14,213	4	0	4	134	14,393	4	0	4	136				
				T4M	12,944	4	0	4	122	13,945	4	0	4	132	14,121	4	0	4	133				
				TFTM	13,279	4	0	4	125	14,305	4	0	4	135	14,486	4	0	4	137				
				TSVS	13,372	3	0	1	126	14,405	4	0	1	136	14,588	4	0	1	138				
				T5S	13,260	3	0	1	125	14,284	3	0	1	135	14,465	3	0	1	136				
				T5M	13,256	4	0	2	125	14,281	4	0	2	135	14,462	4	0	2	136				
				TSW	13,137	4	0	3	124	14,153	4	0	3	134	14,332	4	0	3	135				
				BLC	10,906	3	0	3	103	11,749	3	0	3	111	11,898	3	0	3	112				
				LCCO	7,789	1	0	3	73	8,391	1	0	3	79	8,497	1	0	3	80				
				RCCO	7,779	4	0	4	73	8,380	4	0	4	79	8,486	4	0	4	80				
				60	700	P11	137W	T1S	16,556	3	0	3	121	17,835	3	0	3	130	18,061	4	0	4	132
								T2S	16,461	4	0	4	120	17,733	4	0	4	129	17,957	4	0	4	131
T2M	16,758	4	0					4	122	18,053	4	0	4	132	18,281	4	0	4	133				
T3S	16,205	4	0					4	118	17,457	4	0	4	127	17,678	4	0	4	129				
T3M	16,748	4	0					4	122	18,042	4	0	4	132	18,271	4	0	4	133				
T4M	16,432	4	0					4	120	17,702	4	0	4	129	17,926	4	0	4	131				
TFTM	16,857	4	0					4	123	18,159	4	0	4	133	18,389	4	0	4	134				
TSVS	16,975	4	0					1	124	18,287	4	0	1	133	18,518	4	0	1	135				
T5S	16,832	4	0					1	123	18,133	4	0	2	132	18,362	4	0	2	134				
T5M	16,828	4	0					2	123	18,128	4	0	2	132	18,358	4	0	2	134				
TSW	16,677	4	0					3	122	17,966	5	0	3	131	18,193	5	0	3	133				
BLC	13,845	3	0					3	101	14,915	3	0	3	109	15,103	3	0	3	110				
LCCO	9,888	1	0					3	72	10,652	2	0	3	78	10,787	2	0	3	79				
RCCO	9,875	4	0					4	72	10,638	4	0	4	78	10,773	4	0	4	79				
60	1050	P12	207W					T1S	22,996	4	0	4	111	24,773	4	0	4	120	25,087	4	0	4	121
								T2S	22,864	4	0	4	110	24,631	5	0	5	119	24,943	5	0	5	120
				T2M	23,277	4	0	4	112	25,075	4	0	4	121	25,393	4	0	4	123				
				T3S	22,509	4	0	4	109	24,248	5	0	5	117	24,555	5	0	5	119				
				T3M	23,263	4	0	4	112	25,061	4	0	4	121	25,378	4	0	4	123				
				T4M	22,824	5	0	5	110	24,588	5	0	5	119	24,899	5	0	5	120				
				TFTM	23,414	5	0	5	113	25,223	5	0	5	122	25,543	5	0	5	123				
				TSVS	23,579	5	0	1	114	25,401	5	0	1	123	25,722	5	0	1	124				
				T5S	23,380	4	0	2	113	25,187	4	0	2	122	25,506	4	0	2	123				
				T5M	23,374	5	0	3	113	25,181	5	0	3	122	25,499	5	0	3	123				
				TSW	23,165	5	0	4	112	24,955	5	0	4	121	25,271	5	0	4	122				
				BLC	19,231	4	0	4	93	20,717	4	0	4	100	20,979	4	0	4	101				
				LCCO	13,734	2	0	3	66	14,796	2	0	4	71	14,983	2	0	4	72				
				RCCO	13,716	4	0	4	66	14,776	4	0	4	71	14,963	4	0	4	72				
				60	1250	P13	231W	T1S	25,400	4	0	4	110	27,363	4	0	4	118	27,709	4	0	4	120
								T2S	25,254	5	0	5	109	27,205	5	0	5	118	27,550	5	0	5	119
T2M	25,710	4	0					4	111	27,696	4	0	4	120	28,047	4	0	4	121				
T3S	24,862	5	0					5	108	26,783	5	0	5	116	27,122	5	0	5	117				
T3M	25,695	5	0					5	111	27,680	5	0	5	120	28,031	5	0	5	121				
T4M	25,210	5	0					5	109	27,158	5	0	5	118	27,502	5	0	5	119				
TFTM	25,861	5	0					5	112	27,860	5	0	5	121	28,212	5	0	5	122				
TSVS	26,043	5	0					1	113	28,056	5	0	1	121	28,411	5	0	1	123				
T5S	25,824	4	0					2	112	27,819	5	0	2	120	28,172	5	0	2	122				
T5M	25,818	5	0					3	112	27,813	5	0	3	120	28,165	5	0	3	122				
TSW	25,586	5	0					4	111	27,563	5	0	4	119	27,912	5	0	4	121				
BLC	21,241	4	0					4	92	22,882	4	0	4	99	23,172	4	0	4	100				
LCCO	15,170	2	0					4	66	16,342	2	0	4	71	16,549	2	0	4	72				
RCCO	15,150	5	0					5	66	16,321	5	0	5	71	16,527	5	0	5	72				

Capable Luminaire

This item is an A+ capable luminaire, which has been designed and tested to provide consistent color appearance and system-level interoperability.

- All configurations of this luminaire meet the Acuity Brands' specification for chromatic consistency
- This luminaire is A+ Certified when ordered with DTL® controls marked by a shaded background. DTL DLL equipped luminaires meet the A+ specification for luminaire to photocontrol interoperability¹
- This luminaire is part of an A+ Certified solution for ROAM® or XPoint™ Wireless control networks, providing out-of-the-box control compatibility with simple commissioning, when ordered with drivers and control options marked by a shaded background¹

To learn more about A+, visit www.acuitybrands.com/aplus.

1. See ordering tree for details.
2. A+ Certified Solutions for ROAM require the order of one ROAM node per luminaire. Sold Separately: [Link to Roam](#); [Link to DTL DLL](#)

FEATURES & SPECIFICATIONS

INTENDED USE

The sleek design of the D-Series Size 1 reflects the embedded high performance LED technology. It is ideal for many commercial and municipal applications, such as parking lots, plazas, campuses, and streetscapes.

CONSTRUCTION

Single-piece die-cast aluminum housing has integral heat sink fins to optimize thermal management through conductive and convective cooling. Modular design allows for ease of maintenance and future light engine upgrades. The LED drivers are mounted in direct contact with the casting to promote low operating temperature and long life. Housing is completely sealed against moisture and environmental contaminants (IP65). Low EPA (1.01 ft²) for optimized pole wind loading.

FINISH

Exterior parts are protected by a zinc-infused Super Durable TGIC thermoset powder coat finish that provides superior resistance to corrosion and weathering. A tightly controlled multi-stage process ensures a minimum 3 mils thickness for a finish that can withstand extreme climate changes without cracking or peeling. Available in both textured and non-textured finishes.

OPTICS

Precision-molded proprietary acrylic lenses are engineered for superior area lighting distribution, uniformity, and pole spacing. Light engines are available in standard 3000 K, 4000 K and 5000 K (70 CRI) configurations. The D-Series Size 1 has zero uplight and qualifies as a Nighttime Friendly™ product, meaning it is consistent with the LEED® and Green Globes™ criteria for eliminating wasteful uplight.

ELECTRICAL

Light engine configurations consist of high-efficacy LEDs mounted to metal-core circuit boards to maximize heat dissipation and promote long life (up to L85/100,000 hours at 25°C). Class 1 electronic drivers are designed to have a power factor >90%, THD <20%, and an expected life of 100,000 hours with <1% failure rate. Easily serviceable 10kV surge protection device meets a minimum Category C Low operation (per ANSI/IEEE C62.41.2).

STANDARD CONTROLS

The DSX1 LED area luminaire has a number of control options. Dusk to dawn controls can be utilized via optional NEMA twist-lock photocell receptacles. Integrated motion sensors with on-board photocells feature field-adjustable programming and are suitable for mounting heights up to 30 feet.

nLIGHT AIR CONTROLS

The DSX1 LED area luminaire is also available with nLight® AIR for the ultimate in wireless control. This powerful controls platform provides out-of-the-box basic motion sensing and photocontrol functionality and is suitable for mounting heights up to 40 feet. Once commissioned using a smartphone and the easy-to-use CLAIRITY app, nLight AIR equipped luminaires can be grouped, resulting in motion sensor and photocell group response without the need for additional equipment. Scheduled dimming with motion sensor over-ride can be achieved when used with the nLight Eclipse. Additional information about nLight Air can be found here.

INSTALLATION

Included mounting block and integral arm facilitate quick and easy installation. Stainless steel bolts fasten the mounting block securely to poles and walls, enabling the D-Series Size 1 to withstand up to a 3.0 G vibration load rating per ANSI C136.31. The D-Series Size 1 utilizes the AERIS™ series pole drilling pattern (template #8). NEMA photocontrol receptacle are also available.

LISTINGS

UL Listed for wet locations. Light engines are IP66 rated; luminaire is IP65 rated. Rated for -40°C minimum ambient. U.S. Patent No. D672,492 S. International patent pending.

DesignLights Consortium® (DLC) Premium qualified product and DLC qualified product.

Not all versions of this product may be DLC Premium qualified or DLC qualified. Please check the DLC Qualified Products List at www.designlights.org/QPL to confirm which versions are qualified.

International Dark-Sky Association (IDA) Fixture Seal of Approval (FSA) is available for all products on this page utilizing 3000K color temperature only.

WARRANTY

5-year limited warranty. Complete warranty terms located at: www.acuitybrands.com/support/customer-support/terms-and-conditions

Note: Actual performance may differ as a result of end-user environment and application.

All values are design or typical values, measured under laboratory conditions at 25 °C.

Specifications subject to change without notice.





D-Series Size 0 LED Area Luminaire



Catalog Number
Notes
Type

Hit the Tab key or mouse over the page to see all interactive elements.

Introduction

The modern styling of the D-Series is striking yet unobtrusive - making a bold, progressive statement even as it blends seamlessly with its environment. The D-Series distills the benefits of the latest in LED technology into a high performance, high efficacy, long-life luminaire. The outstanding photometric performance results in sites with excellent uniformity, greater pole spacing and lower power density. It is ideal for replacing up to 400W metal halide with typical energy savings of 70% and expected service life of over 100,000 hours.

Specifications

EPA:	0.95 ft ² (.09 m ²)
Length:	26" (66.0 cm)
Width:	13" (33.0 cm)
Height ₁ :	3" (7.62 cm)
Height ₂ :	7" (17.8 cm)
Weight (max):	16 lbs (7.25 kg)

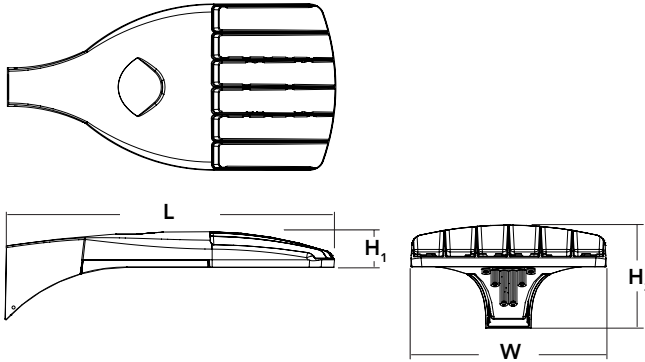

A+ Capable options indicated by this color background.

Ordering Information

EXAMPLE: DSX0 LED P6 40K T3M MVOLT SPA NLTAIR2 PIRHN DDBXD

DSX0 LED	Series	LEDs	Color temperature	Distribution	Voltage	Mounting		
DSX0 LED	Forward optics	P1 P4 P7	30K 3000 K	T1S Type I short (Automotive)	T5S Type V short ²	MVOLT ^{4,5}	Shipped included SPA Square pole mounting RPA Round pole mounting WBA Wall bracket ² SPUMBA Square pole universal mounting adaptor ⁷ RPUMBA Round pole universal mounting adaptor ⁷ Shipped separately KMA8 DDBXD U Mast arm mounting bracket adaptor (specify finish) ⁸	
		P2 P5	40K 4000 K	T2S Type II short	T5M Type V medium ²	120 ⁵		
		P3 P6	50K 5000 K	T2M Type II medium	T5W Type V wide ²	208 ⁵		
		Rotated optics	P10 ¹ P12 ¹		T3S Type III short	BLC Backlight control ³		240 ⁵
			P11 ¹ P13 ¹		T3M Type III medium	LCCO Left corner cutoff ³		277 ⁵
					T4M Type IV medium	RCCO Right corner cutoff ³		347 ^{5,6}
					TFTM Forward throw medium			480 ^{5,6}
					T5VS Type V very short ²			

Control options	Other options	Finish (required)
Shipped installed NLTAIR2 nLight AIR generation 2 enabled ^{9,10} PIRHN Network, high/low motion/ambient sensor ¹¹ PER NEMA twist-lock receptacle only (control ordered separate) ¹² PER5 Five-pin receptacle only (control ordered separate) ^{12,13} PER7 Seven-pin receptacle only (leads exit fixture) (control ordered separate) ^{12,13} DMG 0-10V dimming extend out back of housing for external control (control ordered separate) ¹⁴	PIR High/low, motion/ambient sensor, 8-15' mounting height, ambient sensor enabled at 5fc ^{15,16} PIRH High/low, motion/ambient sensor, 15-30' mounting height, ambient sensor enabled at 5fc ^{15,16} PIR1FC3V High/low, motion/ambient sensor, 8-15' mounting height, ambient sensor enabled at 1fc ^{15,16} PIRH1FC3V High/low, motion/ambient sensor, 15-30' mounting height, ambient sensor enabled at 1fc ^{15,16} FAO Field adjustable output ¹⁷	Shipped installed HS House-side shield ¹⁸ SF Single fuse (120, 277, 347V) ⁵ DF Double fuse (208, 240, 480V) ⁵ L90 Left rotated optics ¹ R90 Right rotated optics ¹ DDL Diffused drop lens ¹⁸ Shipped separately BS Bird spikes ¹⁹ EGS External glare shield
		DDBXD Dark bronze DBLXD Black DNAXD Natural aluminum DWHXD White DDBTXD Textured dark bronze DBLBXD Textured black DNATXD Textured natural aluminum DWHGXD Textured white



Ordering Information

Accessories

Ordered and shipped separately.

DLL127F 1.5 JU	Photocell - SSL twist-lock (120-277V) ²⁰
DLL347F 1.5 CUL JU	Photocell - SSL twist-lock (347V) ²⁰
DLL480F 1.5 CUL JU	Photocell - SSL twist-lock (480V) ²⁰
DSHORT SBK U	Shorting cap ²³
DSXOHS 20C U	House-side shield for P1,P2,P3 and P4 ¹⁸
DSXOHS 30C U	House-side shield for P10,P11,P12 and P13 ¹⁸
DSXOHS 40C U	House-side shield for P5,P6 and P7 ¹⁸
DSXODDL U	Diffused drop lens (polycarbonate) ¹⁸
PUMBA DDBXD U*	Square and round pole universal mounting bracket adaptor (specify finish) ²¹
KMA8 DDBXD U	Mast arm mounting bracket adaptor (specify finish) ¹⁷
DSXOEGS (FINISH) U	External glare shield

For more control options, visit [DTL](#) and [ROAM](#) online. Link to [nLight Air 2](#)

NOTES

- P10, P11, P12 and P13 and rotated options (L90 or R90) only available together.
- Any Type 5 distribution with photocell, is not available with WBA.
- Not available with HS or DDL.
- MVOLT driver operates on any line voltage from 120-277V (50/60 Hz).
- Single fuse (SF) requires 120V, 277V or 347V. Double fuse (DF) requires 208V, 240V or 480V.
- Not available with BL30, BL50 or PNMT options.
- Universal mounting brackets intended for retrofit on existing pre-drilled poles only. 1.5 G vibration load rating per ANCI C136.31.
- Must order fixture with SPA mounting. Must be ordered as a separate accessory; see Accessories information. For use with 2-3/8" mast arm (not included).
- Must be ordered with PIRHN.
- Sensor cover available only in dark bronze, black, white and natural aluminum colors.
- Must be ordered with NLTAIR2. For more information on nLight Air 2 visit [this link](#).
- Photocell ordered and shipped as a separate line item from Acuity Brands Controls. See accessories. Shorting Cap included.
- If ROAM[®] node required, it must be ordered and shipped as a separate line item from Acuity Brands Controls. Shorting Cap included.
- DMG not available with PIRHN, PER5, PER7, PIR, PIRH, PIR1FC3V or PIRH1FC3V.
- Reference Motion Sensor table on page 3.
- Reference PER Table on page 3 to see functionality.
- Not available with other dimming controls options.
- Not available with BLC, LCCO and RCCO distribution.
- Must be ordered with fixture for factory pre-drilling.
- Requires luminaire to be specified with PER, PER5 or PER7 option. See PER Table on page 3.
- For retrofit use only.

EGS – External Glare Shield

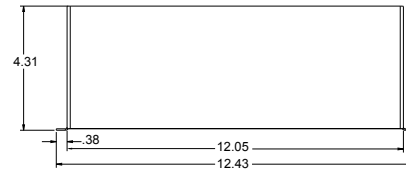
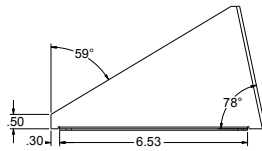
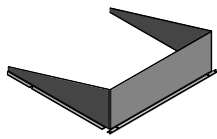

Drilling

HANDHOLE ORIENTATION (from top of pole)

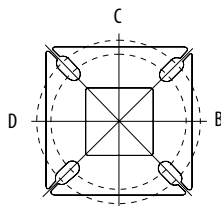

A
Handhole

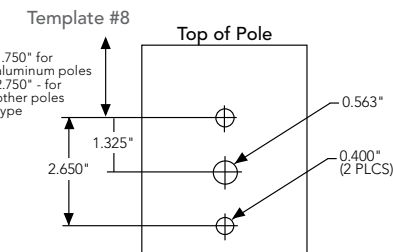

Tenon Mounting Slipfitter

Tenon O.D.	Single Unit	2 at 180°	2 at 90°	3 at 120°	3 at 90°	4 at 90°
2-3/8"	AST20-190	AST20-280	AST20-290	AST20-320	AST20-390	AST20-490
2-7/8"	AST25-190	AST25-280	AST25-290	AST25-320	AST25-390	AST25-490
4"	AST35-190	AST35-280	AST35-290	AST35-320	AST35-390	AST35-490

Mounting Option	Drilling Template	Single	2 @ 180	2 @ 90	3 @ 90	3 @ 120	4 @ 90
Head Location		Side B	Side B & D	Side B & C	Side B, C & D	Round Pole Only	Side A, B, C & D
Drill Nomenclature	#8	DM19AS	DM28AS	DM29AS	DM39AS	DM32AS	DM49AS
Minimum Acceptable Outside Pole Dimension							
SPA	#8	2-7/8"	2-7/8"	3.5"	3.5"		3.5"
RPA	#8	2-7/8"	2-7/8"	3.5"	3.5"	3"	3.5"
SPUMBA	#5	2-7/8"	3"	4"	4"		4"
RPUMBA	#5	2-7/8"	3.5"	5"	5"	3.5"	5"

Isofootcandle plots for the DSX0 LED 40C 1000 40K. Distances are in units of mounting height (20').

LEGEND

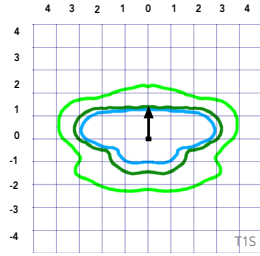
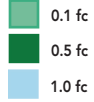

Test No.

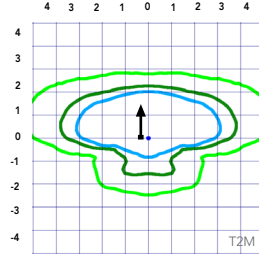

Test No.

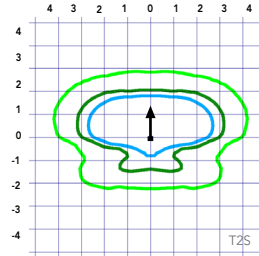

Test No. LTL23457P25 tested in accordance with IESNA LM-79-08.

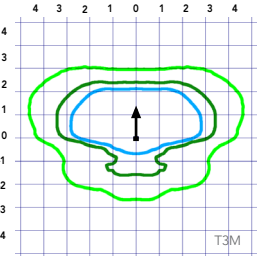

Test No. LTL23457P25 tested in accordance with IESNA LM-79-08.

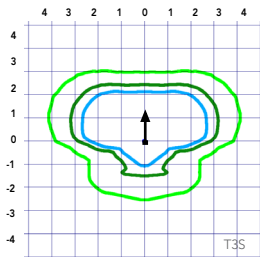

Test No. LTL23457P25 tested in accordance with IESNA LM-79-08.

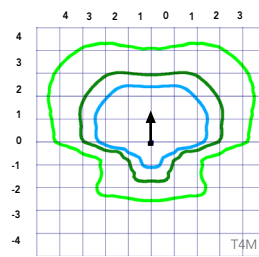

Test No.

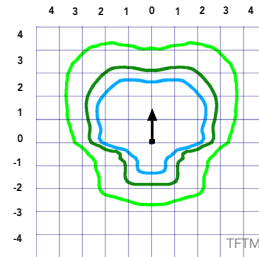

Test No.

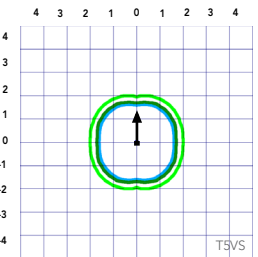

Test No.

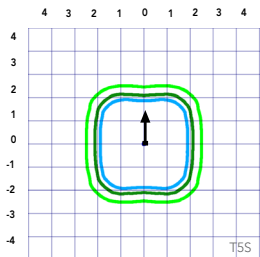

Test No.

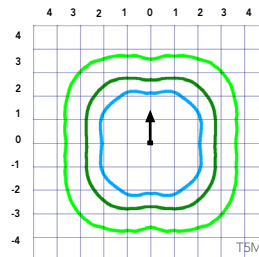

Test No.

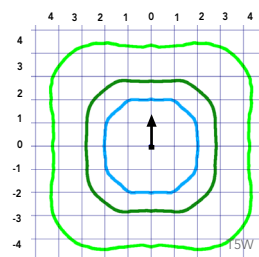

Test No. LTL23451P25 tested in accordance with IESNA LM-79-08.

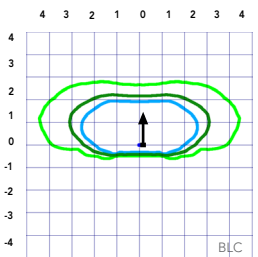

Test No.

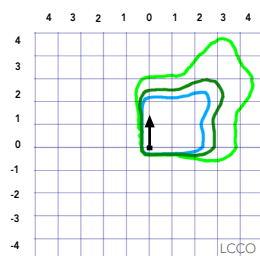

Test No.

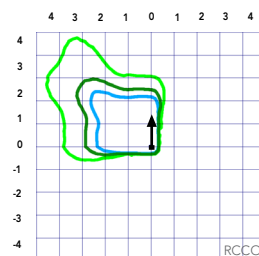

Test No.

Performance Data

Lumen Ambient Temperature (LAT) Multipliers

Use these factors to determine relative lumen output for average ambient temperatures from 0-40°C (32-104°F).

Ambient		Lumen Multiplier
0°C	32°F	1.04
5°C	41°F	1.04
10°C	50°F	1.03
15°C	59°F	1.02
20°C	68°F	1.01
25°C	77°C	1.00
30°C	86°F	0.99
35°C	95°F	0.98
40°C	104°F	0.97

Projected LED Lumen Maintenance

Data references the extrapolated performance projections for the platforms noted in a **25°C ambient**, based on 10,000 hours of LED testing (tested per IESNA LM-80-08 and projected per IESNA TM-21-11).

To calculate LLF, use the lumen maintenance factor that corresponds to the desired number of operating hours below. For other lumen maintenance values, contact factory.

Operating Hours	Lumen Maintenance Factor
25,000	0.96
50,000	0.92
100,000	0.85

Motion Sensor Default Settings						
Option	Dimmed State	High Level (when triggered)	Photocell Operation	Dwell Time	Ramp-up Time	Ramp-down Time
PIR or PIRH	3V (37%) Output	10V (100%) Output	Enabled @ 5FC	5 min	3 sec	5 min
*PIR1FC3V or PIRH1FC3V	3V (37%) Output	10V (100%) Output	Enabled @ 1FC	5 min	3 sec	5 min

*for use with separate Dusk to Dawn or timer.

Controls Options

Nomenclature	Description	Functionality	Primary control device	Notes
FAO	Field adjustable output device installed inside the luminaire; wired to the driver dimming leads.	Allows the luminaire to be manually dimmed, effectively trimming the light output.	FAO device	Cannot be used with other controls options that need the 0-10V leads
DS	Drivers wired independently for 50/50 luminaire operation	The luminaire is wired to two separate circuits, allowing for 50/50 operation.	Independently wired drivers	Requires two separately switched circuits. Consider nLight AIR as a more cost effective alternative.
PERS or PER7	Twist-lock photocell receptacle	Compatible with standard twist-lock photocells for dusk to dawn operation, or advanced control nodes that provide 0-10V dimming signals.	Twist-lock photocells such as DLL Elite or advanced control nodes such as ROAM.	Pins 4 & 5 to dimming leads on driver, Pins 6 & 7 are capped inside luminaire
PIR or PIRH	Motion sensors with integral photocell. PIR for 8-15' mounting; PIRH for 15-30' mounting	Luminaires dim when no occupancy is detected.	Acuity Controls SBGR	Also available with PIRH1FC3V when the sensor photocell is used for dusk-to-dawn operation.
NLTAIR2 PIRHN	nLight AIR enabled luminaire for motion sensing, photocell and wireless communication.	Motion and ambient light sensing with group response. Scheduled dimming with motion sensor over-ride when wirelessly connected to the nLight Eclipse.	nLight Air rSDGR	nLight AIR sensors can be programmed and commissioned from the ground using the CIAIRity Pro app.

Electrical Load

					Current (A)					
	Performance Package	LED Count	Drive Current	Wattage	120	208	240	277	347	480
Forward Optics (Non-Rotated)	P1	20	530	38	0.32	0.18	0.15	0.15	0.10	0.08
	P2	20	700	49	0.41	0.23	0.20	0.19	0.14	0.11
	P3	20	1050	71	0.60	0.37	0.32	0.27	0.21	0.15
	P4	20	1400	92	0.77	0.45	0.39	0.35	0.28	0.20
	P5	40	700	89	0.74	0.43	0.38	0.34	0.26	0.20
	P6	40	1050	134	1.13	0.65	0.55	0.48	0.39	0.29
	P7	40	1300	166	1.38	0.80	0.69	0.60	0.50	0.37
Rotated Optics (Requires L90 or R90)	P10	30	530	53	0.45	0.26	0.23	0.21	0.16	0.12
	P11	30	700	72	0.60	0.35	0.30	0.27	0.20	0.16
	P12	30	1050	104	0.88	0.50	0.44	0.39	0.31	0.23
	P13	30	1300	128	1.08	0.62	0.54	0.48	0.37	0.27

Lumen Output

Lumen values are from photometric tests performed in accordance with IESNA LM-79-08. Data is considered to be representative of the configurations shown, within the tolerances allowed by Lighting Facts. Contact factory for performance data on any configurations not shown here.

Forward Optics																							
Power Package	LED Count	Drive Current	System Watts	Dist. Type	30K (3000 K, 70 CRI)					40K (4000 K, 70 CRI)					50K (5000 K, 70 CRI)								
					Lumens	B	U	G	LPW	Lumens	B	U	G	LPW	Lumens	B	U	G	LPW				
P1	20	530	38W	T1S	4,369	1	0	1	115	4,706	1	0	1	124	4,766	1	0	1	125				
				T2S	4,364	1	0	1	115	4,701	1	0	1	124	4,761	1	0	1	125				
				T2M	4,387	1	0	1	115	4,726	1	0	1	124	4,785	1	0	1	126				
				T3S	4,248	1	0	1	112	4,577	1	0	1	120	4,634	1	0	1	122				
				T3M	4,376	1	0	1	115	4,714	1	0	1	124	4,774	1	0	1	126				
				T4M	4,281	1	0	1	113	4,612	1	0	2	121	4,670	1	0	2	123				
				TFTM	4,373	1	0	1	115	4,711	1	0	2	124	4,771	1	0	2	126				
				TSVS	4,548	2	0	0	120	4,900	2	0	0	129	4,962	2	0	0	131				
				TSS	4,552	2	0	0	120	4,904	2	0	0	129	4,966	2	0	0	131				
				TSM	4,541	3	0	1	120	4,891	3	0	1	129	4,953	3	0	1	130				
				TSW	4,576	3	0	2	120	4,929	3	0	2	130	4,992	3	0	2	131				
				BLC	3,586	1	0	1	94	3,863	1	0	1	102	3,912	1	0	1	103				
				LCCO	2,668	1	0	1	70	2,874	1	0	2	76	2,911	1	0	2	77				
				RCCO	2,668	1	0	1	70	2,874	1	0	2	76	2,911	1	0	2	77				
				P2	20	700	49W	T1S	5,570	1	0	1	114	6,001	1	0	1	122	6,077	2	0	2	124
T2S	5,564	1	0					2	114	5,994	1	0	2	122	6,070	2	0	2	124				
T2M	5,593	1	0					1	114	6,025	1	0	1	123	6,102	1	0	1	125				
T3S	5,417	1	0					2	111	5,835	1	0	2	119	5,909	2	0	2	121				
T3M	5,580	1	0					2	114	6,011	1	0	2	123	6,087	1	0	2	124				
T4M	5,458	1	0					2	111	5,880	1	0	2	120	5,955	1	0	2	122				
TFTM	5,576	1	0					2	114	6,007	1	0	2	123	6,083	1	0	2	124				
TSVS	5,799	2	0					0	118	6,247	2	0	0	127	6,327	2	0	0	129				
TSS	5,804	2	0					0	118	6,252	2	0	0	128	6,332	2	0	1	129				
TSM	5,789	3	0					1	118	6,237	3	0	1	127	6,316	3	0	1	129				
TSW	5,834	3	0					2	119	6,285	3	0	2	128	6,364	3	0	2	130				
BLC	4,572	1	0					1	93	4,925	1	0	1	101	4,987	1	0	1	102				
LCCO	3,402	1	0					2	69	3,665	1	0	2	75	3,711	1	0	2	76				
RCCO	3,402	1	0					2	69	3,665	1	0	2	75	3,711	1	0	2	76				
P3	20	1050	71W					T1S	7,833	2	0	2	110	8,438	2	0	2	119	8,545	2	0	2	120
				T2S	7,825	2	0	2	110	8,429	2	0	2	119	8,536	2	0	2	120				
				T2M	7,865	2	0	2	111	8,473	2	0	2	119	8,580	2	0	2	121				
				T3S	7,617	2	0	2	107	8,205	2	0	2	116	8,309	2	0	2	117				
				T3M	7,846	2	0	2	111	8,452	2	0	2	119	8,559	2	0	2	121				
				T4M	7,675	2	0	2	108	8,269	2	0	2	116	8,373	2	0	2	118				
				TFTM	7,841	2	0	2	110	8,447	2	0	2	119	8,554	2	0	2	120				
				TSVS	8,155	3	0	0	115	8,785	3	0	0	124	8,896	3	0	0	125				
				TSS	8,162	3	0	1	115	8,792	3	0	1	124	8,904	3	0	1	125				
				TSM	8,141	3	0	2	115	8,770	3	0	2	124	8,881	3	0	2	125				
				TSW	8,204	3	0	2	116	8,838	4	0	2	124	8,950	4	0	2	126				
				BLC	6,429	1	0	2	91	6,926	1	0	2	98	7,013	1	0	2	99				
				LCCO	4,784	1	0	2	67	5,153	1	0	2	73	5,218	1	0	2	73				
				RCCO	4,784	1	0	2	67	5,153	1	0	2	73	5,218	1	0	2	73				
				P4	20	1400	92W	T1S	9,791	2	0	2	106	10,547	2	0	2	115	10,681	2	0	2	116
T2S	9,780	2	0					2	106	10,536	2	0	2	115	10,669	2	0	2	116				
T2M	9,831	2	0					2	107	10,590	2	0	2	115	10,724	2	0	2	117				
T3S	9,521	2	0					2	103	10,256	2	0	2	111	10,386	2	0	2	113				
T3M	9,807	2	0					2	107	10,565	2	0	2	115	10,698	2	0	2	116				
T4M	9,594	2	0					2	104	10,335	2	0	3	112	10,466	2	0	3	114				
TFTM	9,801	2	0					2	107	10,558	2	0	2	115	10,692	2	0	2	116				
TSVS	10,193	3	0					1	111	10,981	3	0	1	119	11,120	3	0	1	121				
TSS	10,201	3	0					1	111	10,990	3	0	1	119	11,129	3	0	1	121				
TSM	10,176	4	0					2	111	10,962	4	0	2	119	11,101	4	0	2	121				
TSW	10,254	4	0					3	111	11,047	4	0	3	120	11,186	4	0	3	122				
BLC	8,036	1	0					2	87	8,656	1	0	2	94	8,766	1	0	2	95				
LCCO	5,979	1	0					2	65	6,441	1	0	2	70	6,523	1	0	3	71				
									5,979	1	0	2	65	6,441	1	0	2	70	6,523	1	0	3	71

Performance Data

Lumen Output

Lumen values are from photometric tests performed in accordance with IESNA LM-79-08. Data is considered to be representative of the configurations shown, within the tolerances allowed by Lighting Facts. Contact factory for performance data on any configurations not shown here.

Forward Optics																			
Power Package	LED Count	Drive Current	System Watts	Dist. Type	30K (3000 K, 70 CRI)					40K (4000 K, 70 CRI)					50K (5000 K, 70 CRI)				
					Lumens	B	U	G	LPW	Lumens	B	U	G	LPW	Lumens	B	U	G	LPW
P5	40	700	89W	T1S	10,831	2	0	2	122	11,668	2	0	2	131	11,816	2	0	2	133
				T2S	10,820	2	0	2	122	11,656	2	0	2	131	11,803	2	0	2	133
				T2M	10,876	2	0	2	122	11,716	2	0	2	132	11,864	2	0	2	133
				T3S	10,532	2	0	2	118	11,346	2	0	2	127	11,490	2	0	2	129
				T3M	10,849	2	0	2	122	11,687	2	0	2	131	11,835	2	0	2	133
				T4M	10,613	2	0	3	119	11,434	2	0	3	128	11,578	2	0	3	130
				TFTM	10,842	2	0	2	122	11,680	2	0	2	131	11,828	2	0	2	133
				TSVS	11,276	3	0	1	127	12,148	3	0	1	136	12,302	3	0	1	138
				T5S	11,286	3	0	1	127	12,158	3	0	1	137	12,312	3	0	1	138
				T5M	11,257	4	0	2	126	12,127	4	0	2	136	12,280	4	0	2	138
				T5W	11,344	4	0	3	127	12,221	4	0	3	137	12,375	4	0	3	139
				BLC	8,890	1	0	2	100	9,576	1	0	2	108	9,698	1	0	2	109
				LCCO	6,615	1	0	3	74	7,126	1	0	3	80	7,216	1	0	3	81
				RCCO	6,615	1	0	3	74	7,126	1	0	3	80	7,216	1	0	3	81
P6	40	1050	134W	T1S	14,805	3	0	3	110	15,949	3	0	3	119	16,151	3	0	3	121
				T2S	14,789	3	0	3	110	15,932	3	0	3	119	16,134	3	0	3	120
				T2M	14,865	3	0	3	111	16,014	3	0	3	120	16,217	3	0	3	121
				T3S	14,396	3	0	3	107	15,509	3	0	3	116	15,705	3	0	3	117
				T3M	14,829	2	0	3	111	15,975	3	0	3	119	16,177	3	0	3	121
				T4M	14,507	2	0	3	108	15,628	3	0	3	117	15,826	3	0	3	118
				TFTM	14,820	2	0	3	111	15,965	3	0	3	119	16,167	3	0	3	121
				TSVS	15,413	4	0	1	115	16,604	4	0	1	124	16,815	4	0	1	125
				T5S	15,426	3	0	1	115	16,618	4	0	1	124	16,828	4	0	1	126
				T5M	15,387	4	0	2	115	16,576	4	0	2	124	16,786	4	0	2	125
				T5W	15,506	4	0	3	116	16,704	4	0	3	125	16,915	4	0	3	126
				BLC	12,151	1	0	2	91	13,090	1	0	2	98	13,255	1	0	2	99
				LCCO	9,041	1	0	3	67	9,740	1	0	3	73	9,863	1	0	3	74
				RCCO	9,041	1	0	3	67	9,740	1	0	3	73	9,863	1	0	3	74
P7	40	1300	166W	T1S	17,023	3	0	3	103	18,338	3	0	3	110	18,570	3	0	3	112
				T2S	17,005	3	0	3	102	18,319	3	0	3	110	18,551	3	0	3	112
				T2M	17,092	3	0	3	103	18,413	3	0	3	111	18,646	3	0	3	112
				T3S	16,553	3	0	3	100	17,832	3	0	3	107	18,058	3	0	3	109
				T3M	17,051	3	0	3	103	18,369	3	0	3	111	18,601	3	0	3	112
				T4M	16,681	3	0	3	100	17,969	3	0	3	108	18,197	3	0	3	110
				TFTM	17,040	3	0	3	103	18,357	3	0	4	111	18,590	3	0	4	112
				TSVS	17,723	4	0	1	107	19,092	4	0	1	115	19,334	4	0	1	116
				T5S	17,737	4	0	2	107	19,108	4	0	2	115	19,349	4	0	2	117
				T5M	17,692	4	0	2	107	19,059	4	0	2	115	19,301	4	0	2	116
				T5W	17,829	5	0	3	107	19,207	5	0	3	116	19,450	5	0	3	117
				BLC	13,971	2	0	2	84	15,051	2	0	2	91	15,241	2	0	2	92
				LCCO	10,396	1	0	3	63	11,199	1	0	3	67	11,341	1	0	3	68
					10,396	1	0	3	63	11,199	1	0	3	67	11,341	1	0	3	68

Performance Data

Lumen Output

Lumen values are from photometric tests performed in accordance with IESNA LM-79-08. Data is considered to be representative of the configurations shown, within the tolerances allowed by Lighting Facts. Contact factory for performance data on any configurations not shown here.

Rotated Optics																			
Power Package	LED Count	Drive Current	System Watts	Dist. Type	30K (3000 K, 70 CRI)					40K (4000 K, 70 CRI)					50K (5000 K, 70 CRI)				
					Lumens	B	U	G	LPW	Lumens	B	U	G	LPW	Lumens	B	U	G	LPW
P10	30	530	53W	T1S	6,727	2	0	2	127	7,247	3	0	3	137	7,339	3	0	3	138
				T2S	6,689	3	0	3	126	7,205	3	0	3	136	7,297	3	0	3	138
				T2M	6,809	3	0	3	128	7,336	3	0	3	138	7,428	3	0	3	140
				T3S	6,585	3	0	3	124	7,094	3	0	3	134	7,183	3	0	3	136
				T3M	6,805	3	0	3	128	7,331	3	0	3	138	7,424	3	0	3	140
				T4M	6,677	3	0	3	126	7,193	3	0	3	136	7,284	3	0	3	137
				TFTM	6,850	3	0	3	129	7,379	3	0	3	139	7,472	3	0	3	141
				TSVS	6,898	3	0	0	130	7,431	3	0	0	140	7,525	3	0	0	142
				T5S	6,840	2	0	1	129	7,368	2	0	1	139	7,461	2	0	1	141
				T5M	6,838	3	0	1	129	7,366	3	0	2	139	7,460	3	0	2	141
				TSW	6,777	3	0	2	128	7,300	3	0	2	138	7,393	3	0	2	139
				BLC	5,626	2	0	2	106	6,060	2	0	2	114	6,137	2	0	2	116
				LCCO	4,018	1	0	2	76	4,328	1	0	2	82	4,383	1	0	2	83
				RCCO	4,013	3	0	3	76	4,323	3	0	3	82	4,377	3	0	3	83
				P11	30	700	72W	T1S	8,594	3	0	3	119	9,258	3	0	3	129	9,376
T2S	8,545	3	0					3	119	9,205	3	0	3	128	9,322	3	0	3	129
T2M	8,699	3	0					3	121	9,371	3	0	3	130	9,490	3	0	3	132
T3S	8,412	3	0					3	117	9,062	3	0	3	126	9,177	3	0	3	127
T3M	8,694	3	0					3	121	9,366	3	0	3	130	9,484	3	0	3	132
T4M	8,530	3	0					3	118	9,189	3	0	3	128	9,305	3	0	3	129
TFTM	8,750	3	0					3	122	9,427	3	0	3	131	9,546	3	0	3	133
TSVS	8,812	3	0					0	122	9,493	3	0	0	132	9,613	3	0	0	134
T5S	8,738	3	0					1	121	9,413	3	0	1	131	9,532	3	0	1	132
T5M	8,736	3	0					2	121	9,411	3	0	2	131	9,530	3	0	2	132
TSW	8,657	4	0					2	120	9,326	4	0	2	130	9,444	4	0	2	131
BLC	7,187	3	0					3	100	7,742	3	0	3	108	7,840	3	0	3	109
LCCO	5,133	1	0					2	71	5,529	1	0	2	77	5,599	1	0	2	78
RCCO	5,126	3	0					3	71	5,522	3	0	3	77	5,592	3	0	3	78
P12	30	1050	104W					T1S	12,149	3	0	3	117	13,088	3	0	3	126	13,253
				T2S	12,079	4	0	4	116	13,012	4	0	4	125	13,177	4	0	4	127
				T2M	12,297	3	0	3	118	13,247	3	0	3	127	13,415	3	0	3	129
				T3S	11,891	4	0	4	114	12,810	4	0	4	123	12,972	4	0	4	125
				T3M	12,290	3	0	3	118	13,239	4	0	4	127	13,407	4	0	4	129
				T4M	12,058	4	0	4	116	12,990	4	0	4	125	13,154	4	0	4	126
				TFTM	12,369	4	0	4	119	13,325	4	0	4	128	13,494	4	0	4	130
				TSVS	12,456	3	0	1	120	13,419	3	0	1	129	13,589	4	0	1	131
				T5S	12,351	3	0	1	119	13,306	3	0	1	128	13,474	3	0	1	130
				T5M	12,349	4	0	2	119	13,303	4	0	2	128	13,471	4	0	2	130
				TSW	12,238	4	0	3	118	13,183	4	0	3	127	13,350	4	0	3	128
				BLC	10,159	3	0	3	98	10,944	3	0	3	105	11,083	3	0	3	107
				LCCO	7,256	1	0	3	70	7,816	1	0	3	75	7,915	1	0	3	76
				RCCO	7,246	3	0	3	70	7,806	4	0	4	75	7,905	4	0	4	76
				P13	30	1300	128W	T1S	14,438	3	0	3	113	15,554	3	0	3	122	15,751
T2S	14,355	4	0					4	112	15,465	4	0	4	121	15,660	4	0	4	122
T2M	14,614	3	0					3	114	15,744	4	0	4	123	15,943	4	0	4	125
T3S	14,132	4	0					4	110	15,224	4	0	4	119	15,417	4	0	4	120
T3M	14,606	4	0					4	114	15,735	4	0	4	123	15,934	4	0	4	124
T4M	14,330	4	0					4	112	15,438	4	0	4	121	15,633	4	0	4	122
TFTM	14,701	4	0					4	115	15,836	4	0	4	124	16,037	4	0	4	125
TSVS	14,804	4	0					1	116	15,948	4	0	1	125	16,150	4	0	1	126
T5S	14,679	3	0					1	115	15,814	3	0	1	124	16,014	3	0	1	125
T5M	14,676	4	0					2	115	15,810	4	0	2	124	16,010	4	0	2	125
TSW	14,544	4	0					3	114	15,668	4	0	3	122	15,866	4	0	3	124
BLC	7,919	3	0					3	62	8531	3	0	3	67	8639	3	0	3	67
LCCO	5,145	1	0					2	40	5543	1	0	2	43	5613	1	0	2	44
RCCO	5,139	3	0					3	40	5536	3	0	3	43	5606	3	0	3	44

Capable Luminaire

This item is an A+ capable luminaire, which has been designed and tested to provide consistent color appearance and system-level interoperability.

- All configurations of this luminaire meet the Acuity Brands' specification for chromatic consistency
- This luminaire is A+ Certified when ordered with DTL® controls marked by a shaded background. DTL DLL equipped luminaires meet the A+ specification for luminaire to photocontrol interoperability¹
- This luminaire is part of an A+ Certified solution for ROAM® or XPoint™ Wireless control networks, providing out-of-the-box control compatibility with simple commissioning, when ordered with drivers and control options marked by a shaded background¹

To learn more about A+, visit www.acuitybrands.com/aplus.

1. See ordering tree for details.
2. A+ Certified Solutions for ROAM require the order of one ROAM node per luminaire.
Sold Separately: [Link to Roam](#); [Link to DTL DLL](#)

FEATURES & SPECIFICATIONS

INTENDED USE

The sleek design of the D-Series Size 0 reflects the embedded high performance LED technology. It is ideal for many commercial and municipal applications, such as parking lots, plazas, campuses, and pedestrian areas.

CONSTRUCTION

Single-piece die-cast aluminum housing has integral heat sink fins to optimize thermal management through conductive and convective cooling. Modular design allows for ease of maintenance and future light engine upgrades. The LED driver is mounted in direct contact with the casting to promote low operating temperature and long life. Housing is completely sealed against moisture and environmental contaminants (IP65). Low EPA (0.95 ft²) for optimized pole wind loading.

FINISH

Exterior parts are protected by a zinc-infused Super Durable TGIC thermoset powder coat finish that provides superior resistance to corrosion and weathering. A tightly controlled multi-stage process ensures a minimum 3 mils thickness for a finish that can withstand extreme climate changes without cracking or peeling. Available in both textured and non-textured finishes.

OPTICS

Precision-molded proprietary acrylic lenses are engineered for superior area lighting distribution, uniformity, and pole spacing. Light engines are available in 3000 K, 4000 K or 5000 K (70 CRI) configurations. The D-Series Size 0 has zero uplight and qualifies as a Nighttime Friendly™ product, meaning it is consistent with the LEED® and Green Globes™ criteria for eliminating wasteful uplight.

ELECTRICAL

Light engine(s) configurations consist of high-efficacy LEDs mounted to metal-core circuit boards to maximize heat dissipation and promote long life (up to L85/100,000 hours at 25°C). Class 1 electronic drivers are designed to have a power factor >90%, THD <20%, and an expected life of 100,000 hours with <1% failure rate. Easily serviceable 10kV surge protection device meets a minimum Category C Low operation (per ANSI/IEEE C62.41.2).

STANDARD CONTROLS

The DSX0 LED area luminaire has a number of control options. Dusk to dawn controls can be utilized via optional NEMA twist-lock photocell receptacles. Integrated motion sensors with on-board photocells feature field-adjustable programming and are suitable for mounting heights up to 30 feet.

nLIGHT AIR CONTROLS

The DSX0 LED area luminaire is also available with nLight® AIR for the ultimate in wireless control. This powerful controls platform provides out-of-the-box basic motion sensing and photocontrol functionality and is suitable for mounting heights up to 40 feet. Once commissioned using a smartphone and the easy-to-use CLAIRITY app, nLight AIR equipped luminaires can be grouped, resulting in motion sensor and photocell group response without the need for additional equipment. Scheduled dimming with motion sensor over-ride can be achieved when used with the nLight Eclipse. Additional information about nLight Air can be found [here](#).

INSTALLATION

Included mounting block and integral arm facilitate quick and easy installation. Stainless steel bolts fasten the mounting block securely to poles and walls, enabling the D-Series Size 0 to withstand up to a 3.0 G vibration load rating per ANSI C136.31. The D-Series Size 0 utilizes the AERIS™ series pole drilling pattern (template #8). Optional terminal block and NEMA photocell receptacle are also available.

LISTINGS

UL Listed for wet locations. Light engines are IP66 rated; luminaire is IP65 rated. Rated for -40°C minimum ambient. U.S. Patent No. D672,492 S. International patent pending.

DesignLights Consortium® (DLC) Premium qualified product and DLC qualified product. Not all versions of this product may be DLC Premium qualified or DLC qualified. Please check the DLC Qualified Products List at www.designlights.org/QPL to confirm which versions are qualified.

International Dark-Sky Association (IDA) Fixture Seal of Approval (FSA) is available for all products on this page utilizing 3000K color temperature only.

WARRANTY

5-year limited warranty. Complete warranty terms located at: www.acuitybrands.com/support/customer-support/terms-and-conditions

Note: Actual performance may differ as a result of end-user environment and application.

All values are design or typical values, measured under laboratory conditions at 25 °C.

Specifications subject to change without notice.



WEDGE1 LED

Architectural Wall Sconce



Catalog Number

Notes

Type

Hit the Tab key or mouse over the page to see all interactive elements.

Specifications

Depth: 5.5"
Height: 8"
Width: 9"
Weight: 9 lbs
 (without options)

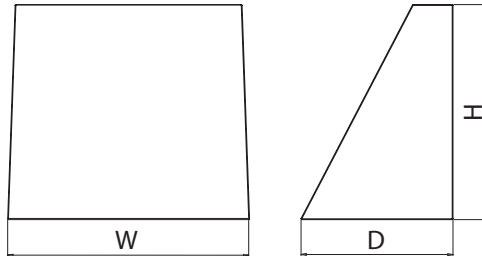

Introduction

The WEDGE LED family is designed to meet specifier's every wall-mounted lighting need in a widely accepted shape that blends with any architecture. The clean rectilinear design comes in four sizes with lumen packages ranging from 1,200 to 25,000 lumens, providing true site-wide solution.

WEDGE1 delivers up to 2,000 lumens with a soft, non-pixelated light source, creating a visually comfortable environment. The compact size of WEDGE1, with its integrated emergency battery backup option, makes it an ideal over-the-door wall-mounted lighting solution.

WEDGE LED Family Overview

Luminaire	Standard EM, 0°C	Cold EM, -20°C	Sensor	Lumens (4000K)					
				P1	P2	P3	P4	P5	P6
WEDGE1 LED	4W	--	--	1,200	2,000	--	--	--	--
WEDGE2 LED	10W	18W	Standalone / nLight	1,200	2,000	3,000	4,500	6,000	--
WEDGE3 LED	15W	18W	Standalone / nLight	7,500	8,500	10,000	12,000	--	--
WEDGE4 LED	--	--	Standalone / nLight	12,000	16,000	18,000	20,000	22,000	25,000

Ordering Information

EXAMPLE: WEDGE1 LED P2 40K 80CRI VF MVOLT PE DDBXD

Series	Package	Color Temperature	CRI	Distribution	Voltage	Mounting
WEDGE1 LED	P1 P2	27K 2700K 30K 3000K 35K 3500K 40K 4000K 50K ¹ 5000K	80CRI 90CRI	VF Visual comfort forward throw VW Visual comfort wide	MVOLT 347 ²	Shipped included SRM Surface mounting bracket Shipped separately AWS 3/8inch Architectural wall spacer BBW Surface-mounted back box PBBW Premium surface-mounted back box (top, left, right conduit entry)

Options	Finish
E4WH ³ Emergency battery backup, CEC compliant (4W, 0°C min)	DDBXD Dark bronze
PE ⁴ Photocell, Button Type	DBLXD Black
DS Dual switching (comes with 2 drivers and 2 light engines; see page 3 for details)	DNAXD Natural aluminum
DMG 0-10V dimming wires pulled outside fixture (for use with an external control, ordered separately)	DWHXD White
BCE Bottom conduit entry for premium back box (PBBW). Total of 4 entry points.	DSSXD Sandstone
	DDBTXD Textured dark bronze
	DBLTXD Textured black
	DNATXD Textured natural aluminum
	DWHGXD Textured white
	DSSTXD Textured sandstone

Accessories

Ordered and shipped separately.

WEDGEAWS DDBXD U	WEDGE 3/8inch Architectural Wall Spacer (specify finish)
WEDGE1PBBW DDBXD U	WEDGE1 Premium surface-mounted back box (specify finish)
WSBBW DDBXD U	Surface - mounted back box (specify finish)

NOTES

- 50K not available in 90CRI.
- 347V not available with E4WH, DS or PE.
- E4WH not available with PE or DS.
- PE not available with DS.



COMMERCIAL OUTDOOR

One Lithonia Way • Conyers, Georgia 30012 • Phone: 1-800-705-SERV (7378) • www.lithonia.com
 © 2019-2020 Acuity Brands Lighting, Inc. All rights reserved.

WEDGE1 LED
 Rev. 01/07/20

Performance Data

Lumen Output

Lumen values are from photometric tests performed in accordance with IESNA LM-79-08. Data is considered to be representative of the configurations shown, within the tolerances allowed by Lighting Facts. Contact factory for performance data on any configurations not shown here.

Performance Package	System Watts	Dist. Type	27K (2700K, 80 CRI)		30K (3000K, 80 CRI)		35K (3500K, 80 CRI)		40K (4000K, 80 CRI)		50K (5000K, 80 CRI)	
			Lumens	LPW	Lumens	LPW	Lumens	LPW	Lumens	LPW	Lumens	LPW
P1	10W	VF	1,120	112	1,161	116	1,194	119	1,227	123	1,235	123
		VW	1,122	112	1,163	116	1,196	120	1,229	123	1,237	124
P2	15W	VF	1,806	120	1,872	125	1,925	128	1,978	132	1,992	133
		VW	1,809	120	1,876	125	1,929	128	1,982	132	1,996	133

Electrical Load

Performance Package	System Watts	Current (A)				
		120V	208V	240V	277V	347V
P1	10W	0.082	0.049	0.043	0.038	--
	13W	--	--	--	--	0.046
P2	15W	0.132	0.081	0.072	0.064	--
	18W	--	--	--	--	0.056

Lumen Multiplier for 90CRI

CCT	Multiplier
27K	0.845
30K	0.867
35K	0.845
40K	0.885
50K	0.898

Lumen Ambient Temperature (LAT) Multipliers

Use these factors to determine relative lumen output for average ambient temperatures from 0-40°C (32-104°F).

Ambient	Lumen Multiplier
0°C / 32°F	1.03
10°C / 50°F	1.02
20°C / 68°F	1.01
25°C / 77°F	1.00
30°C / 86°F	0.99
40°C / 104°F	0.98

Projected LED Lumen Maintenance

Data references the extrapolated performance projections for the platforms noted in a 25°C ambient, based on 10,000 hours of LED testing (tested per IESNA LM-80-08 and projected per IESNA TM-21-11).

To calculate LLF, use the lumen maintenance factor that corresponds to the desired number of operating hours below. For other lumen maintenance values, contact factory.

Operating Hours	0	25,000	50,000	100,000
Lumen Maintenance Factor	1.0	>0.96	>0.95	>0.91

Photometric Diagrams

To see complete photometric reports or download .ies files for this product, visit the Lithonia Lighting WDGE LED homepage. Tested in accordance with IESNA LM-79 and LM-80 standards.

LEGEND

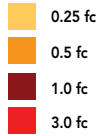

MH = 8ft
Grid = 8ft x 8ft

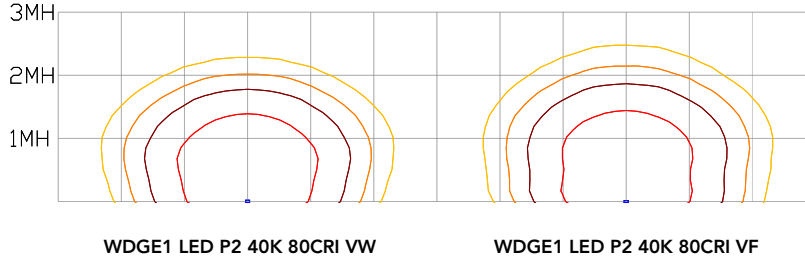

Emergency Egress Options

Emergency Battery Backup

The emergency battery backup is integral to the luminaire — no external housing required! This design provides reliable emergency operation while maintaining the aesthetics of the product. All emergency battery backup configurations include an independent secondary driver with an integral relay to immediately detect loss of normal power and automatically energize the luminaire. The emergency battery will power the luminaire for a minimum duration of 90 minutes (maximum duration of three hours) from the time normal power is lost and maintain a minimum of 60% of the light output at the end of 90minutes.

Applicable codes: NFPA 70/NEC – section 700.16, NFPA 101 Life Safety Code Section 7.9

The example below shows illuminance of 1 fc average and 0.1 fc minimum in emergency mode with E4WH and VF distribution.

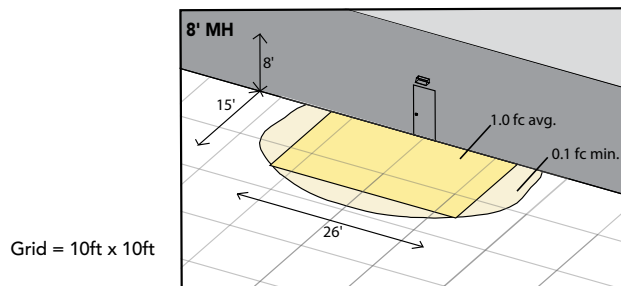

WDGE1 LED xx 40K 80CRI VF MVOLT E4WH

Dual Switching (DS) Option

The dual switching option offers operational redundancy that certain codes require. With this option the luminaire comes integrated with two drivers and two light engines. These work completely independent to each other so that a failure of any individual component does not cause the whole luminaire to go dark. This option is typically used with a back generator or inverter providing emergency power.

Applicable codes: NFPA 70/NEC – section 700.16, NFPA 101 Life Safety Code Section 7.9

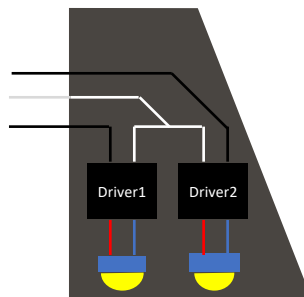



E4WH – 4W Emergency Battery Backup

D = 5.5"

H = 8"

W = 9"



PBBW – Premium Back Box

D = 1.75"

H = 8"

W = 9"

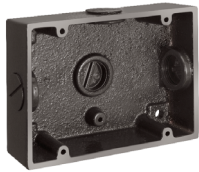

BBW – Standard Back Box

D = 1.5"

H = 4"

W = 5.5"



AWS – 3/8inch Architectural Wall Spacer

D = 0.38"

H = 4.4"

W = 7.5"

FEATURES & SPECIFICATIONS

INTENDED USE

Common architectural look, with clean rectilinear shape, of the WDGE LED was designed to blend with any type of construction, whether it be tilt-up, frame or brick. Applications include commercial offices, warehouses, hospitals, schools, malls, restaurants, and other commercial buildings.

CONSTRUCTION

The single-piece die-cast aluminum housing integrates secondary heat sinks to optimize thermal transfer from the internal light engine heat sinks and promote long life. The driver is mounted in direct contact with the casting for a low operating temperature and long life. The die-cast door frame is fully gasketed with a one-piece solid silicone gasket to keep out moisture and dust, providing an IP66 rating for the luminaire.

FINISH

Exterior painted parts are protected by a zinc-infused Super Durable TGIC thermoset powder coat finish that provides superior resistance to corrosion and weathering. A tightly controlled multi-stage process ensures a 3 mils thickness for a finish that can withstand extreme climate changes without cracking or peeling. Standard Super Durable colors include dark bronze, black, natural aluminum, sandstone and white. Available in textured and non-textured finishes.

OPTICS

Well crafted reflector optics allow the light engine to be recessed within the luminaire, providing visual comfort, superior distribution, uniformity, and spacing in wall-mount applications. The WDGE LED has zero uplight and qualifies as a Nighttime Friendly™ product, meaning it is consistent with the LEED® and Green Globes™ criteria for eliminating wasteful uplight.

ELECTRICAL

Light engine consists of high-efficiency LEDs mounted to metal-core circuit boards to maximize heat dissipation and promote long life (up to L91/100,000 hours at 25°C). The electronic driver has a power factor of >90%, THD <20%. Luminaire comes with built in 6kV surge protection, which meets a minimum Category C low exposure (per ANSI/IEEE C62.41.2).

INSTALLATION

A universal mounting plate with integral mounting support arms allows the fixture to hinge down for easy access while making wiring connections. The 3/8" Architectural Wall Spacer (AWS) can be used to create a floating appearance or to accommodate small imperfections in the wall surface.

LISTINGS

CSA certified to U.S. and Canadian standards. Luminaire is IP66 rated. PIR options are rated for wet location. Rated for -40°C minimum ambient. DesignLights Consortium® (DLC) Premium qualified product and DLC qualified product. Not all versions of this product may be DLC Premium qualified or DLC qualified. Please check the DLC Qualified Products List at www.designlights.org/QPL to confirm which versions are qualified.

WARRANTY

5-year limited warranty. Complete warranty terms located at: www.acuitybrands.com/support/customer-support/terms-and-conditions

Note: Actual performance may differ as a result of end-user environment and application. All values are design or typical values, measured under laboratory conditions at 25 °C. Specifications subject to change without notice.

Model No :: **20050LEDDMG-BL**
 Name :: **Edge**



Project Name :: _____
 Location :: _____
 Type :: _____
 Quantity :: _____
 Notes :: _____

Product Information

Product ID :: 20050
 UPC Code :: 641594230116
 Mounting Type :: Wall
 Finish :: Black (BL)
 Diffuser :: N/A
 Alt. Finishes :: Satin (SAT)
 Alt. Diffusers :: N/A

Product Dimensions

Fixture		Canopy	
Length ::	N/A	Length ::	N/A
Width ::	5.5"	Width ::	N/A
Diameter ::	N/A	Diameter ::	N/A
Extension ::	3.9"	Height ::	N/A
Height ::	7.1"		
Overall Height ::	N/A Max.		



Technical Specifications

Qualifications	Specifications	Photometrics	Recommended Dimmers
Location Rating :: Wet	Frame Material :: Metal	CCT :: 3000	(ELV) LUTRON Diva DVELV-303P; (ELV) LUTRON Maestro MAELV-600; (ELV) LUTRON Skylark SELV-300P; (TRIAC) LEVITON Decora Sureslide 6672; (TRIAC) LEVITON Decora Sureslide 6674; (TRIAC) LUTRON Diva DVCL-153P; (TRIAC) LUTRON Skylark CL
Certification :: cETLus	Diffuser Material :: Glass	CRI :: 90	
IES File :: No	Voltage :: 120v	Wattage :: 13 W	
JA8 Compliant :: No	Lamping Type :: Dedicated LED	Nominal Lumens :: 1293	
Title 20 Compliant :: N/A	Lamping Base :: SSL	Delivered Lumens :: N/A	
Energy Star :: No	Lamp Quantity :: 1	Custom Options :: N/A; Additional Items :: N/A	
ADA Compliant :: Yes	Lamp Wattage :: 13 W		
Marine Grade :: Yes	Total Wattage :: 13 W		
Emergency Lighting :: No	Lamps Included :: Yes		
Warranty :: 5 Year Limited	J-Box Type :: Standard		

Line Drawing #1

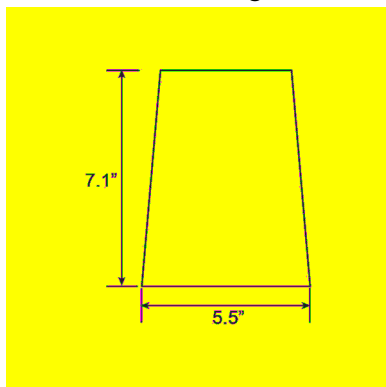

Line Drawing #2

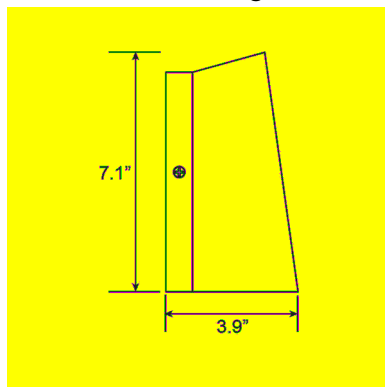

IES File

Image Not Available

Toll Free 800-828-5483 or www.AccessLighting.com

14410 Myford Road, Irvine, CA 92606

The information provided is subject to change without notice. ©2018 Access Lighting Corporation. All Rights Reserved
 Rev. 201902 Filename:: 20050LEDDMG-BL.pdf

