



---

## ##. Land Use and Building Form Standards

## Land Use and Building Form Descriptions and Standards

The land use categories and building forms regulated by this Chapter are defined in this Section. Standards or requirements that apply to particular land uses, whether these are allowed as permitted or conditional uses, are also included in this Section.

### Building Form Definitions and Design Standards

#### Intent.

A variety of building forms are defined here in order to identify and establish basic design parameters for those buildings that may be appropriate in one or more zoning districts. Purposes of design standards are:

- A. To ensure compatibility between different land uses and building forms;
- B. To encourage building forms that respect their context;
- C. To encourage pedestrian movement by encouraging building forms that present an active face to the street.

*Note that some residential land uses are identical to, or closely related to, residential building types. Others can occur in a broad variety of buildings. A multi-family dwelling unit, for example, can occupy a courtyard building, a large or small apartment building, or a mixed-use building.*

#### Applicability.

The design standards in this Section shall apply to new buildings or building additions that exceed the building's gross floor area by more than 50%. Building additions shall comply with the design standards to the extent feasible, given the placement of the existing building.

Some design standards are closely linked to a specific building form (for example, a parking building). Other design standards will vary by district, and will be listed in those district chapters. Building types that are not listed in this Section may be allowed if they meet the intent and other design standards of the district where they would be located.

## Residential Building Forms

### Single-Family Detached Building

A single-family dwelling with yards on all sides, oriented to the street, with an attached or detached garage.

#### Access and Entry

Each dwelling shall have direct access from a porch, stoop or courtyard to the street

Parking, loading and trash disposal may be accessed from an alley or driveway.

#### Parking

Surface parking shall be located in the side or rear yard.

Garages may be attached or detached.

Any street-facing wall that contains an attached garage door may occupy no more than 50% of the width of that building façade, measured at grade. That portion of the façade that contains the garage door must be recessed at least 2 feet behind the remainder of the façade. This standard may be waived only in cases where topography or lot configuration makes it impractical to meet this standard.

Detached garages must be located in the side or rear yard, meeting the standards for Accessory Buildings in Section \_\_\_.

#### Frontage

Each building must include a stoop, porch or terrace serving one or both dwelling units, oriented towards the primary abutting street.

#### Building Width

Buildings facing a public street may not be wider than 50 feet along a single plane on the axis facing the street. Additional building wings facing the street shall be set back at least 10 feet behind the front plane of the building.

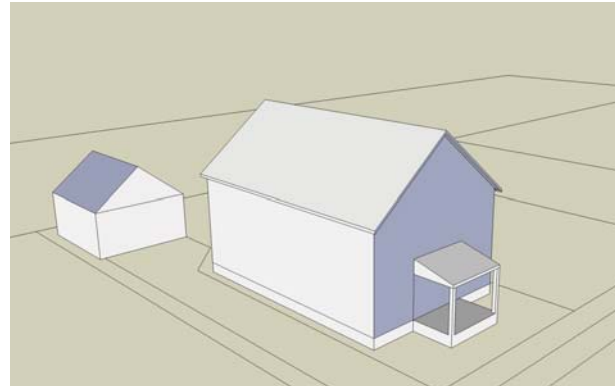

Typical Single Family Detached Building

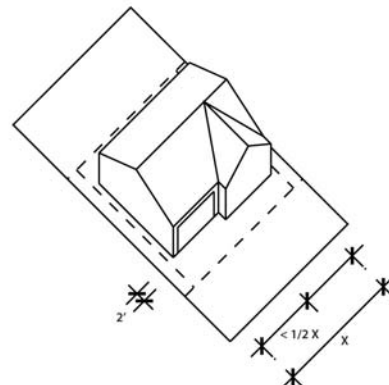

Attached Garage Recess

### Two-Flat Building

A building containing two dwelling units that are vertically stacked one above the other, with a separate entrance to each unit and with yards on all sides.

### Three-Flat Building

A building containing three dwelling units that are vertically stacked one above the other, with a separate entrance to each unit and with yards on all sides.

#### Access and Entry

At least one of the dwellings shall have direct access from a common porch or stoop facing the front lot line and street.

Parking, loading and trash disposal may be accessed from an alley or driveway.

#### Parking

Surface parking shall be located in the side or rear yard.

Garages may be attached or detached, but are typically detached. Detached garages must be located in the side or rear yard, meeting the standards for Accessory Buildings in Section \_\_\_\_.

Any street-facing wall that contains an attached garage door may occupy no more than 50% of the width of that building façade, measured at grade. That portion of the façade that contains the garage door must be recessed at least 2 feet behind the remainder of the façade. This standard may be waived only in cases where topography or lot configuration makes it impractical to meet this standard.

#### Frontage

Each building must include a stoop, porch or terrace serving at least one of the dwelling units.

#### Building Width

Buildings facing a public street may not be wider than 40 feet along a single plane on the axis facing the street. Additional building wings facing the street shall be set back at least 10 feet behind the front plane of the building.

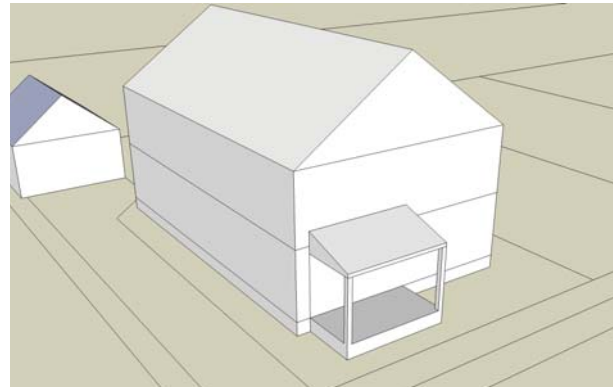

Typical Two-Flat Building

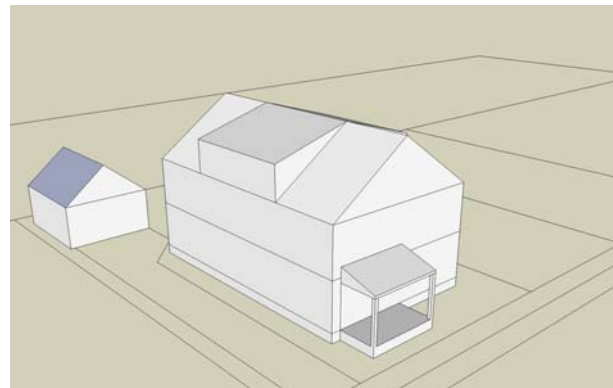

Typical Three-Flat Building

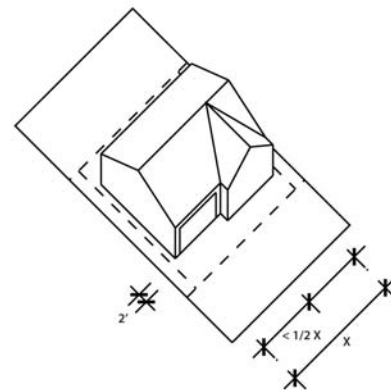

Attached Garage Recess

## Two-Family Building, Twin

A building containing two attached dwelling units that share a common side wall and that are usually on separate lots, with the common wall at the lot line. If the dwellings are on separate lots, the common wall must be located on the side lot line. The dwellings can also be treated as condominiums, with a third ownership area consisting of the remainder of the lots.

### Access and Entry

Each dwelling shall have direct access from a common or separate porch or stoop; at least one entrance shall face the front lot line.

Parking, loading and trash disposal may be accessed from an alley or driveway. Both units may, (and are encouraged to) share a common driveway.

### Parking

Garages may be attached or detached. Detached garages must be located in the side or rear yard, meeting the standards for Accessory Buildings in Section \_\_.

Any street-facing wall that contains an attached garage door may occupy no more than 50% of the width of that building façade, measured at grade. That portion of the façade that contains the garage door must be recessed at least 2 feet behind the remainder of the façade. This standard may be waived only in cases where topography or lot configuration makes it impractical to meet this standard.

### Frontage

Each building must include a stoop, porch or terrace serving one or both dwelling units, oriented towards the primary abutting street.

### Building Width

Buildings facing a public street may not be wider than 50 feet along a single plane on the axis facing the street. Additional building wings facing the street shall be set back at least 10 feet behind the front plane of the building.

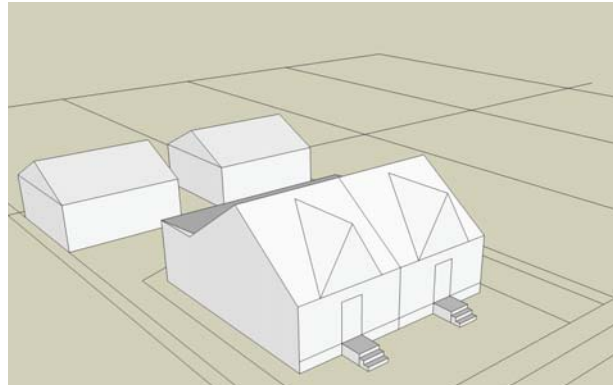

Typical Two-Family Twin Building

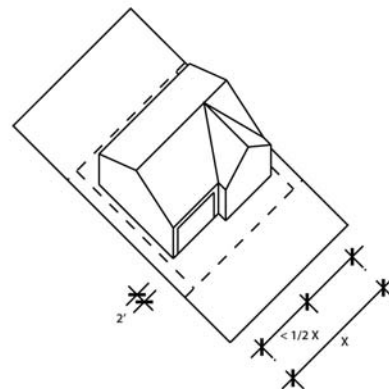

Attached Garage Recess

## Single-Family Attached Building, Townhouse, Rowhouse

A dwelling unit within a linear group of horizontally attached dwellings, each having a private entrance and totally exposed front and rear walls to be used for access, light and ventilation. Buildings may be oriented to the street or to a central green or courtyard.

### Access and Entry

The principal entry to each dwelling shall have direct access to the street or to a courtyard.

Parking, loading and trash disposal may be accessed from an alley or common sideyard driveway serving one or more buildings.

### Parking

Parking shall be located behind each building or in a common parking court in the interior of a block. Parking may be in a variety of configurations: surface, “tuck-under,” underground, or within an attached or detached garage to the rear of the principal building.

### Frontage

Each dwelling must include a stoop or porch fronting the street or a common green or courtyard.

Buildings facing a public street shall be comprised of individual units, articulated vertically to create visual interest and continuity. Divisions or breaks in materials, entry placement, window bays or other architectural details shall be used to delineate individual units.

### Massing and Articulation

Massing, proportions and articulation of single-family attached buildings should respond to existing residential buildings in their vicinity. Maximum building length shall not exceed 160 feet.

### Landscaping

Front yards shall be landscaped to provide visual screening and privacy. Landscaping may consist of trees, shrubs, and/or groundcovers, in combination with decorative fences or walls.

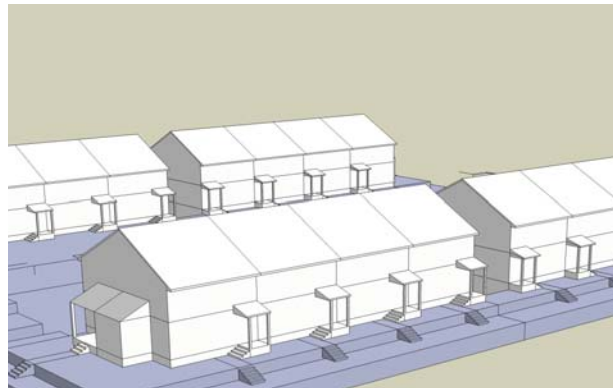

Typical Single Family Attached Buildings



## Small Apartment Building

A multi-story multi-family building with a central entrance oriented to the primary abutting street, containing four to eight units. Buildings of this type are sometimes designed to resemble a large single-family building with a pitched roof.

### Access and Entry

The principal entry to the building shall be oriented to the primary abutting street.

Parking, loading and trash disposal may be accessed from an alley or common sideyard driveway serving one or more buildings.

### Parking

Parking shall be located behind each building, below the building, or in a common parking court in the interior of a block.

### Frontage

Each building must include a stoop or porch fronting the street or a common green or courtyard.

### Massing and Articulation

Massing, proportions and articulation of small apartment buildings should respond to existing residential buildings in their vicinity, including features of those buildings such as roof pitch, proportions of windows and doors, and placement on the lot. Building facades shall be articulated vertically and horizontally for visual interest.

### Landscaping

Front yards shall be landscaped to provide visual screening and privacy. Landscaping may consist of trees, shrubs, and/or groundcovers, in combination with decorative fences or walls.

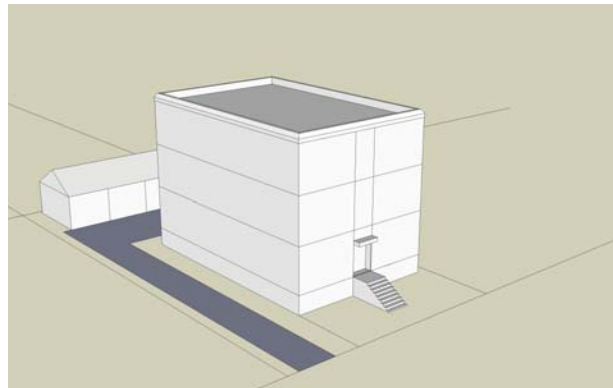

Typical Small Apartment Building



## Large Apartment Building, Stacked Flats

A multi-story building with combined entrances, stairways and elevators, comprised of single- or two-level occupant spaces stacked on top of each other, typically accessed from a central corridor.

### Access and Entry

The principal entry to the building shall be oriented to the primary abutting street.

Parking, loading and trash disposal may be accessed from an alley or common drive serving one or more buildings.

### Parking

Parking shall be located behind each building, under the building, or in a common parking court in the interior of a block. Structured parking visible at ground floor level shall not be visible from the front façade of the building.

### Frontage

Each building must include a stoop or porch fronting the street.

### Massing and Articulation

Massing, proportions and articulation of single-family attached buildings should respond to existing residential buildings in their vicinity. Maximum building length shall not exceed 160 feet. Facades facing a public street shall be vertically articulated at a minimum interval of 40 feet.

### Landscaping

Front yards shall be landscaped to provide visual screening and privacy. Landscaping may consist of trees, shrubs, and/or groundcovers, in combination with decorative fences or walls.

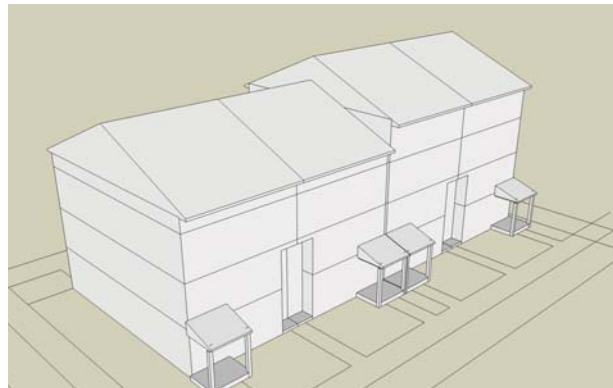

Typical Large Apartment Building





## Courtyard Apartment Building

A multi-story multi-family building designed around an open courtyard abutting a primary street, surrounded by building walls on three sides.

### Access and Entry

The principal entry to the building shall be oriented to the primary abutting street or courtyard. The courtyard shall be oriented to a street and shall be largely visible from the street, but may be separated from the street by a decorative fence.

Parking, loading and trash disposal may be accessed from an alley, through the courtyard, or through a common drive serving one or more buildings.

### Parking

Parking shall be located behind each building or wholly or partially underground. Structured parking visible at ground floor level shall not be visible from the front façade of the building. Surface parking may be located to the side yard of a courtyard building provided that it occupies no more than 25% of the frontage along the primary abutting street.

### Massing and Articulation

Buildings may be divided into individual attached units at ground level or served by shared entrances. Maximum building length shall not exceed 160 feet. Facades facing a public street shall be vertically articulated at a minimum interval of 40 feet.

### Landscaping and Open Space

Courtyards shall be a minimum of 35 feet in width or depth, and shall be maintained as common open space for residents. Courtyards shall be fully landscaped and may also include play structures and other amenities.

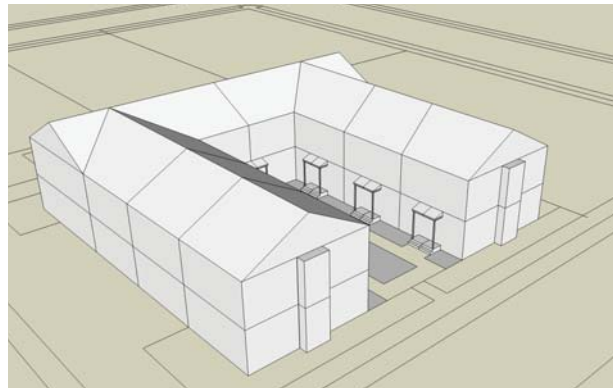

Typical Courtyard Apartment Building



### Carriage House Building

A building containing a detached garage and an accessory dwelling unit of modest size located above the garage. It is located on an alley or on the rear one-third of a lot that includes a principal building.

#### Access and Entry

The principal entry to the unit shall be accessed from the side or rear yard or alley. The entry shall be connected to the abutting street by a paved walkway.

#### Parking

Parking shall be located below or beside the unit and accessed from an alley or sideyard driveway.

#### Building Design

Carriage houses shall employ materials, roof pitch, orientation, door and window placement and proportions, and other details compatible with those of the principal building.

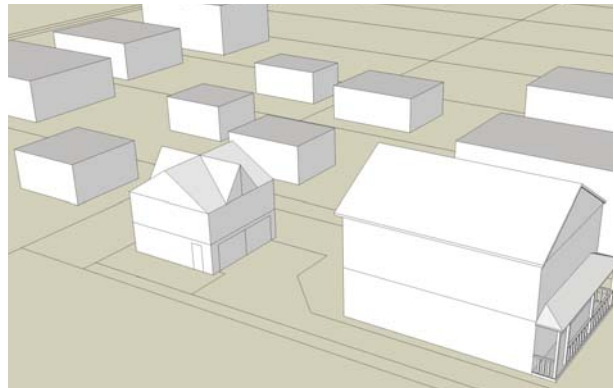

Typical Carriage House Building



## Mixed Use and Non-Residential Building Forms

### Commercial Block Building

A multi-story building that is designed to support a mix of commercial or office uses on the ground floor with office, studio, lodging and/or residential units above. Buildings are typically designed with storefronts or arcades at ground floor.

#### Access and Entry

Principal entry to each ground floor unit shall be a direct entrance from the primary abutting street. Parking, loading and trash disposal may be accessed from an alley or through a sideyard or rearyard drive serving one or more buildings.

#### Parking

Parking shall be not be located between the building's front façade and the street. Parking may be located behind the rear plane of the principal building on the lot, or within a side yard, provided that no more than 70 feet of lot frontage along the primary abutting street is occupied by parking or driveways. Parking may also be wholly or partially underground, or in a common parking area in the interior of a block.

#### Frontage

Buildings shall be designed with storefronts along at least 50% of the front ground floor façade. Stoops and patios may also be used.

#### Massing and Articulation

Maximum building length shall not exceed 160 feet. Facades facing a public street shall be vertically articulated at a minimum interval of 40 feet. Entrances shall be provided at least every 40 feet along the primary abutting street.

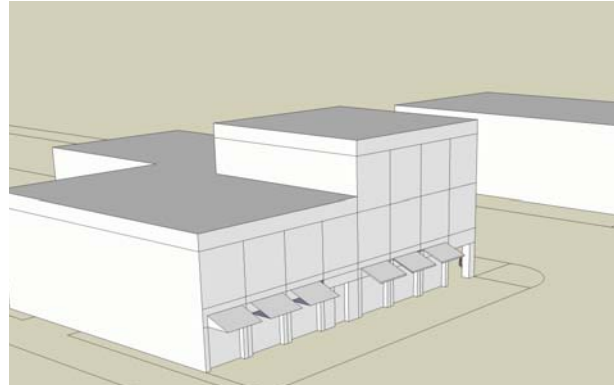

Typical Commercial Block Building



## Liner Building

A specialized building, parallel to the street, which is designed to conceal an area such as a parking lot or loading dock. While liner buildings may include commercial or residential uses, their limited depth (from front to back) makes them more disposed to residential use. Liner buildings may have a small common front yard, but do not include individual private outdoor spaces.

### Access and Entry

Principal entry to each ground floor unit shall be a direct entrance from the primary abutting street.

### Frontage

Buildings may be designed with storefronts, porches or stoops serving one or more units.

### Massing and Articulation

Maximum building length shall not exceed 300 feet. Minimum building depth is 16 feet. Facades facing a public street shall be vertically articulated at a minimum interval of 40 feet. Entrances shall be provided at least every 40 feet along the primary abutting street.

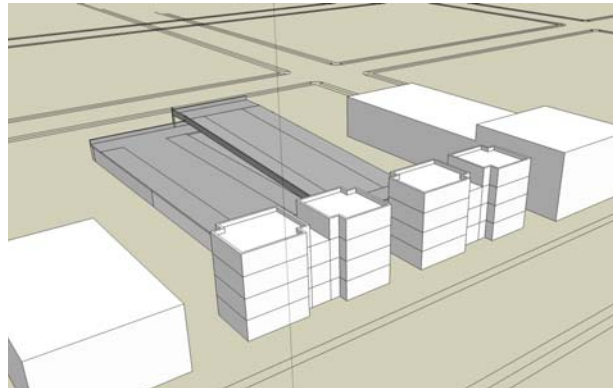

Typical Liner Building



## Parking Building

A multi-story building specifically designed for parking of automobiles on a temporary basis, which may also include ground-floor storefronts and upper-level office space. Often paired with a liner building along the street frontage.

### Access and Entry

Principal entry to each ground floor unit shall be a direct entrance from the primary abutting street. Vehicular entrance drives shall be located and designed to minimize interference with pedestrian movement. Vehicular entrances should be on secondary streets where feasible.

### Building Design

The ground floor of any parking structure abutting a public street or walkway shall be designed and architecturally detailed in a manner consistent with new commercial or mixed-use buildings.

Upper floors shall be designed so that sloped floors typical of parking structures do not dominate the appearance of the façade.

Windows or openings shall be provided that echo those of surrounding buildings.

### Massing and Articulation

Maximum building length shall not exceed 300 feet. Facades facing a public street shall be vertically articulated at a minimum interval of 40 feet. Entrances shall be provided at least every 40 feet along the primary abutting street.



Typical Parking Building

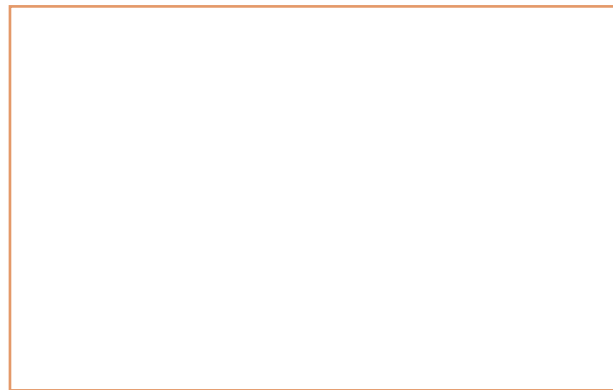

## Live-Work Building

Similar to townhouses in scale and detailing, but with a ground floor designed for small commercial, office and service establishments, often with storefront detailing. Buildings are typically placed close to the sidewalk, although a forecourt or patio design may be used to allow for outdoor seating space.

### Access and Entry

Principal entry to each ground floor unit shall be a direct entrance from the primary abutting street.

### Parking

Parking shall be located behind each building or wholly or partially underground.

### Frontage

Buildings may be designed with storefronts, porches, stoops or forecourts serving one or more units.

### Massing and Articulation

Massing, proportions and articulation of live-work buildings should respond to existing residential buildings in their vicinity. Maximum building length shall not exceed 160 feet. Facades facing a public street shall be vertically articulated at a minimum interval of 40 feet.



Typical Live-Work Building

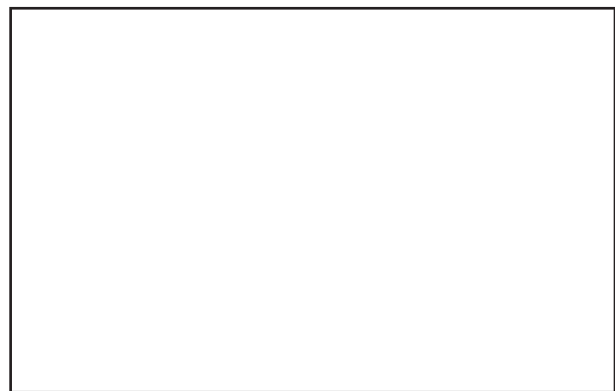

### Residential/Commercial Conversion

A former single-family dwelling converted to commercial or office use. The front yard generally remains as landscaped open space or courtyard; parking must be in the rear. The building form remains residential in character; ground floor windows and doors may be enlarged for improved visibility and access.

#### Access and Entry

Principal entry to each ground floor unit shall be a direct entrance from the primary abutting street.

#### Parking

Parking shall be located behind the building or in a separate common off-street parking facility. Side yard parking may be acceptable if no other alternatives exist.

#### Frontage and Design

The residential form of the building shall generally be maintained. Porch, stoop or patio frontage may be acceptable. Accessibility may be improved through changes in entrance grade or other means.

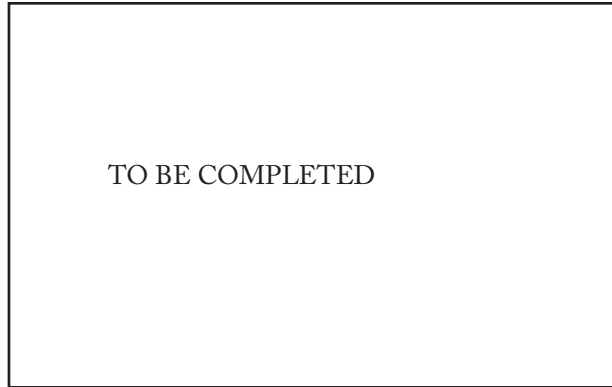

Typical Residential / Commercial Conversion



## Podium Building

A multi-story mixed-use building in which the upper stories are stepped back from a lower base, to provide outdoor terraces, to avoid excessive shadowing of streets or public spaces, or to preserve important views.

### Access and Entry

One or more ground floor entrances from the primary abutting street shall be provided.

### Parking

Parking shall be located behind each building, under the building, or in a common parking court in the interior of a block. Structured parking visible at ground floor level shall not be visible from the front façade of the building.

### Frontage

Buildings may be designed with storefronts, stoops or forecourts.

### Massing and Articulation

Maximum building length shall not exceed 300 feet. Facades facing a public street shall be vertically articulated at a minimum interval of 40 feet.

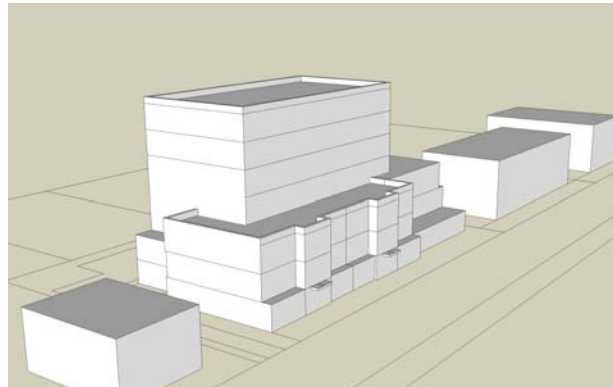

Typical Podium Building





## Flex Building

A variable building type at least two stories in height, designed to accommodate a variety of uses, including combinations of office, retail, lodging, and/or residential. A principal entrance should be oriented to the primary abutting street.

### Access and Entry

One or more ground floor entrances from the primary abutting street shall be provided.

### Parking

Parking shall be not be located between the building's front façade and the street. Parking may be located behind the rear plane of the principal building on the lot, or within a side yard, provided that no more than 70 feet of lot frontage along the primary abutting street is occupied by parking or driveways. Parking may also be wholly or partially underground, or in a common parking area in the interior of a block.

### Frontage

Buildings may be designed with storefronts, stoops or forecourts.

### Massing and Articulation

Maximum building length shall not exceed 300 feet. Facades facing a public street shall be vertically articulated at a minimum interval of 40 feet.

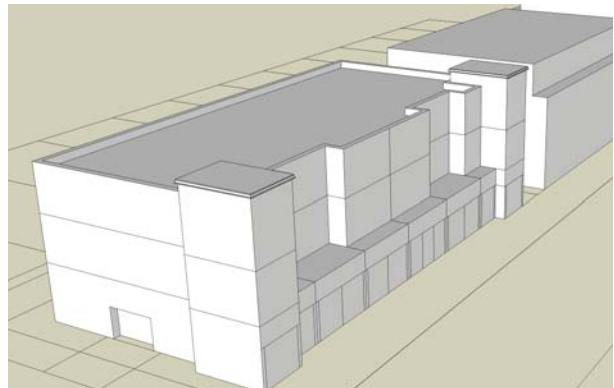

Typical Flex building



## Industrial Building

A large open-floor-plate building that allows maximum flexibility in the types of uses accommodated. Buildings are typically characterized by a tall single story or first floor, and may be set on a raised base to facilitate industrial loading and unloading.

### Access and Entry

One or more ground floor entrances from the primary abutting street shall be provided.

### Parking

Parking may be provided on any side of the building. Loading activities shall be situated to the side or rear of the building.

### Massing and Articulation

Facades facing a public street shall be vertically articulated at a minimum interval of 60 feet.

