



Location
3825 East Washington Avenue

Project Name
Multi-Tenant Retail-Erik's Bikes Boards Skis

Applicant
Erik Saltvold - Erik's Bike Shop/
John Seamon - Iconica

Existing Use
Vacant restaurant

Proposed Use
Demolish restaurant to construct 9,800 sq. ft.
retail building (in Urban Design Dist. 5)

Public Hearing Date
Plan Commission
04 May 2015

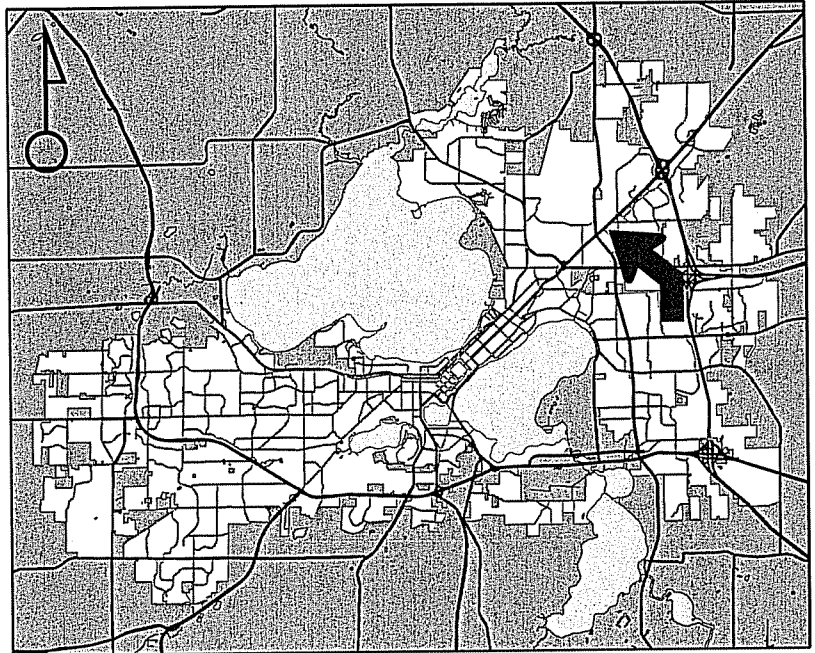

For Questions Contact: Kevin Firchow at: 267-1150 or kfirchow@cityofmadison.com or City Planning at 266-4635

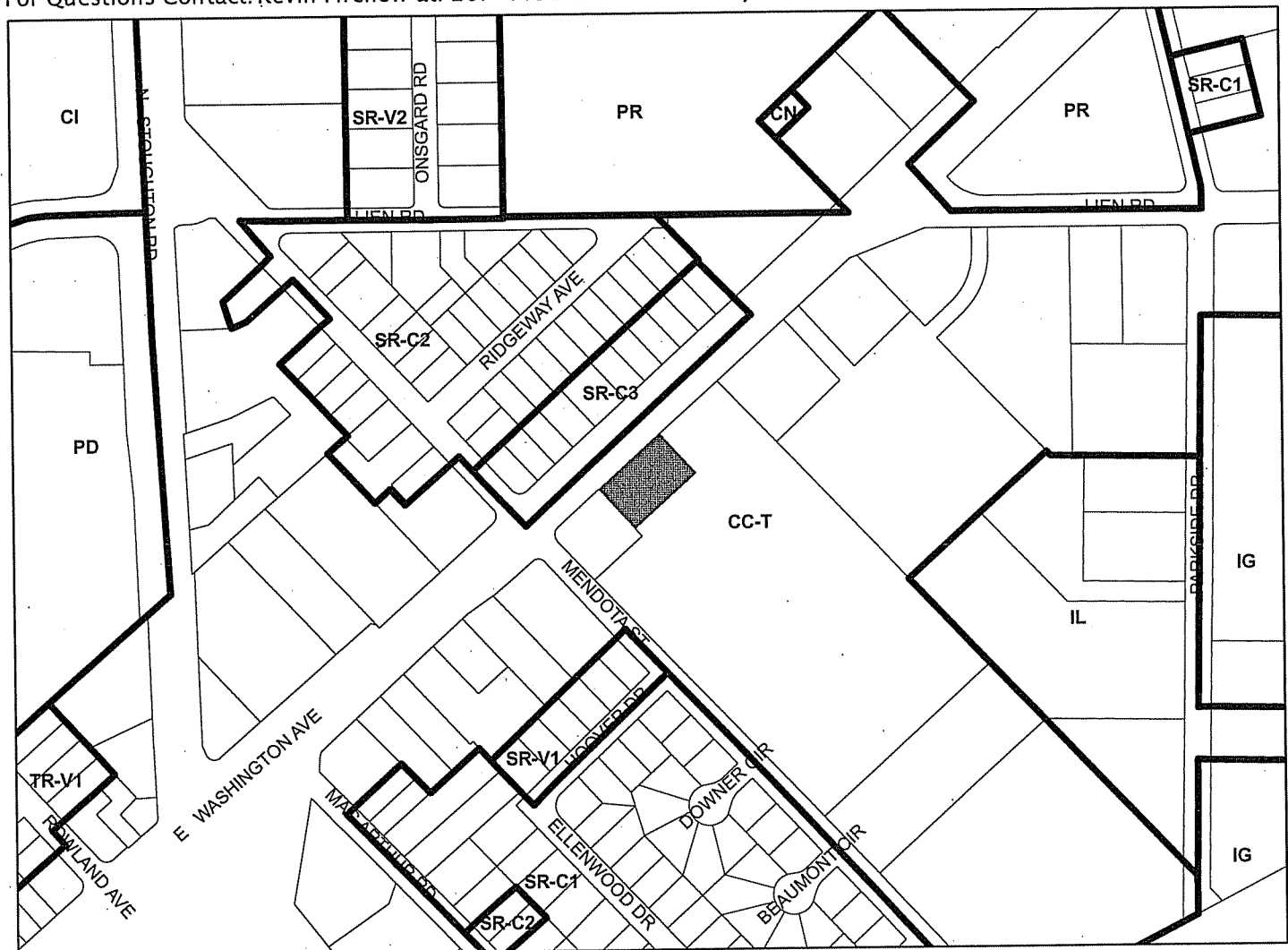

Scale : 1" = 400'

City of Madison, Planning Division : RPJ : Date : 29 April 2015

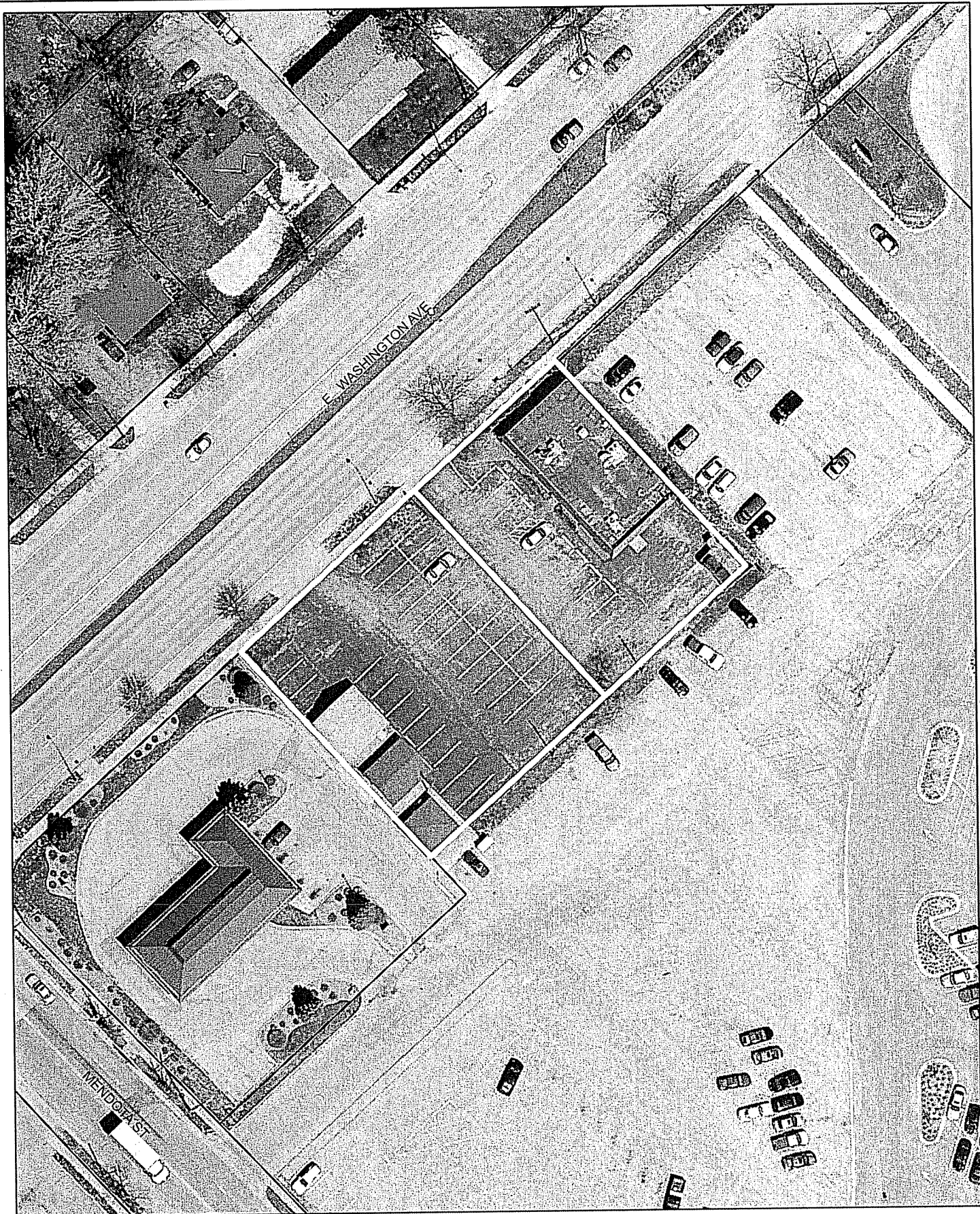



LAND USE APPLICATION

CITY OF MADISON

215 Martin Luther King Jr. Blvd; Room LL-100
PO Box 2985; Madison, Wisconsin 53701-2985
Phone: 608.266.4635 | Facsimile: 608.267.8739

- All Land Use Applications should be filed with the Zoning Administrator at the above address.
- The following information is required for all applications for Plan Commission review except subdivisions or land divisions, which should be filed using the Subdivision Application.
- This form may also be completed online at:
www.cityofmadison.com/developmentcenter/landdevelopment

FOR OFFICE USE ONLY:	
Amt. Paid <u>\$ 600</u>	Receipt No. <u>161120</u>
Date Received <u>12/17/14</u>	
Received By <u>JLK</u>	
Parcel No. <u>0810-332-0911-0</u>	
Aldermanic District <u>17 Joe Clausig</u>	
Zoning District <u>CC-T</u>	
Special Requirements <u>ext CU, UAD-05</u>	
Review Required By: <u>WP-15</u>	
<input type="checkbox"/> Urban Design Commission	<input type="checkbox"/> Plan Commission
<input type="checkbox"/> Common Council	<input type="checkbox"/> Other: _____

Form Effective: February 21, 2013

1. Project Address: 3825 East Washington Avenue
 Project Title (if any): Multi Tenant Retail - Erik's Bikes Boards Skis

2. This is an application for (Check all that apply to your Land Use Application):

- Zoning Map Amendment from _____ to _____
- Major Amendment to Approved PD-GDP Zoning Major Amendment to Approved PD-SIP Zoning
- Review of Alteration to Planned Development (By Plan Commission)
- Conditional Use, or Major Alteration to an Approved Conditional Use
- Demolition Permit
- Other Requests: _____

3. Applicant, Agent & Property Owner Information:

Applicant Name: John Seamon Company: Iconica
 Street Address: 901 Deming Way City/State: Madison, WI Zip: 53717
 Telephone: (608) 664-3550 Fax: (608) 664-3535 Email: john.seamon@iconicacreates.com

Project Contact Person: John Seamon Company: Iconica
 Street Address: 901 Deming Way City/State: Madison, WI Zip: 53717
 Telephone: (608) 664-3550 Fax: (608) 664-3535 Email: john.seamon@iconicacreates.com

Property Owner (if not applicant): Erik Saltvold - Erik's Bike Shop, Inc.
 Street Address: 9201 Penn Ave South, Suite 1 City/State: Bloomington, MN Zip: 55431

4. Project Information:

Provide a brief description of the project and all proposed uses of the site: 8,500 GSF single story mult-tenant retail building and associated on-site parking and landscaping.

Development Schedule: Commencement August 2014 Completion September 2015

5. Required Submittal Information

All Land Use applications are required to include the following:

Project Plans including:*

- Site Plans (fully dimensioned plans depicting project details including all lot lines and property setbacks to buildings; demolished/proposed/altered buildings; parking stalls, driveways, sidewalks, location of existing/proposed signage; HVAC/Utility location and screening details; useable open space; and other physical improvements on a property)
- Grading and Utility Plans (existing and proposed)
- Landscape Plan (including planting schedule depicting species name and planting size)
- Building Elevation Drawings (fully dimensioned drawings for all building sides, labeling primary exterior materials)
- Floor Plans (fully dimensioned plans including interior wall and room location)

Provide collated project plan sets as follows:

- **Seven (7) copies** of a full-sized plan set drawn to a scale of 1 inch = 20 feet (folded or rolled and stapled)
- **Twenty Five (25) copies** of the plan set reduced to fit onto 11 X 17-inch paper (folded and stapled)
- **One (1) copy** of the plan set reduced to fit onto 8 ½ X 11-inch paper

* For projects requiring review by the **Urban Design Commission**, provide **Fourteen (14) additional 11x17 copies** of the plan set. In addition to the above information, all plan sets should also include: 1) Colored elevation drawings with shadow lines and a list of exterior building materials/colors; 2) Existing/proposed lighting with photometric plan & fixture cutsheet; and 3) Contextual site plan information including photographs and layout of adjacent buildings and structures. The applicant shall bring samples of exterior building materials and color scheme to the Urban Design Commission meeting.

Letter of Intent: Provide one (1) Copy per Plan Set describing this application in detail including, but not limited to:

- | | | |
|---|---|--|
| • Project Team | • Building Square Footage | • Value of Land |
| • Existing Conditions | • Number of Dwelling Units | • Estimated Project Cost |
| • Project Schedule | • Auto and Bike Parking Stalls | • Number of Construction & Full-Time Equivalent Jobs Created |
| • Proposed Uses (and ft ² of each) | • Lot Coverage & Usable Open Space Calculations | • Public Subsidy Requested |
| • Hours of Operation | | |

Filing Fee: Refer to the Land Use Application Instructions & Fee Schedule. Make checks payable to: *City Treasurer*.

Electronic Submittal: All applicants are required to submit copies of all items submitted in hard copy with their application as Adobe Acrobat PDF files on a non-returnable CD to be included with their application materials, or by e-mail to pcapplications@cityofmadison.com.

Additional Information may be required, depending on application. Refer to the Supplemental Submittal Requirements.

6. Applicant Declarations

Pre-application Notification: The Zoning Code requires that the applicant notify the district alder and any nearby neighborhood and business associations in writing no later than **30 days prior to FILING this request**. List the alderperson, neighborhood association(s), and business association(s) AND the dates you sent the notices:
Notified Alder Joseph R. Clausius on 11/11/08

→ If a waiver has been granted to this requirement, please attach any correspondence to this effect to this form.

Pre-application Meeting with Staff: Prior to preparation of this application, the applicant is required to discuss the proposed development and review process with Zoning and Planning Division staff; note staff persons and date.

Planning Staff: K. Firchow, P. Anderson Date: 11/13/14 Zoning Staff: D. McAuliff, M. Tucker Date: 11/19/14

The applicant attests that this form is accurately completed and all required materials are submitted:

Name of Applicant John Seamon Relationship to Property: Project Consultant
Authorizing Signature of Property Owner [Signature] Date 12/15/2014

REVISED LANDSCAPE PLAN

EAST WASHINGTON AVENUE

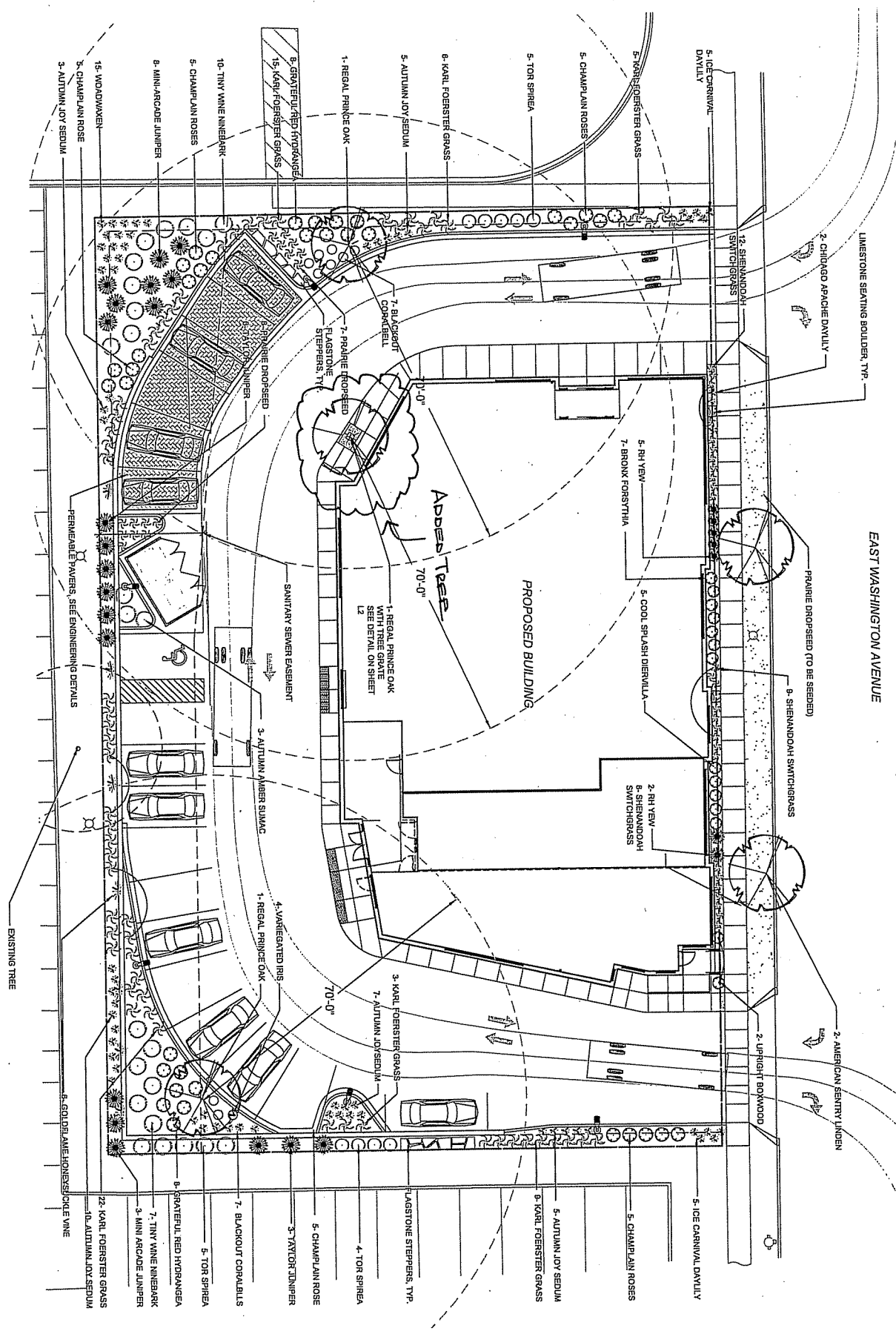

ERIK'S BIKES
SKIS AND BOARDS
MADISON, WISCONSIN

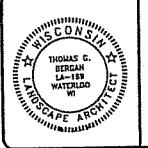

MCKAY NURSERY COMPANY
Since 1897 - An Employee Owned Company
PO Box 165
750 S. Monro Street
Watkins, WI 53294
www.mckaynursery.com
(7) 608.478.2121
(7) 800.225.4242
(7) 608.478.3015

Drawn by
Landscapes
Plan

1" = 10'-0"

DATE	18.05.2013
BY	ES
CHECKED BY	ES
PROJECT NO.	14.11117
SCALE	1/4" = 1'-0"
DATE	10/2
BY	ES

OVERALL LANDSCAPE CALCULATIONS
 DEVELOPED AREA 17,591 SF
 REQUIRED LANDSCAPE UNITS 58 UNITS
 LANDSCAPE POINTS REQUIRED 260 POINTS
 LANDSCAPE POINTS PROVIDED 819 POINTS

PLANT SCHEDULE - PROPOSED PLANTINGS

DECIDUOUS TREES	Quantity	Size	Points
Green Ash 4' x 6' x 10'	2	2 1/2" DBH	105
Red Maple 4' x 6' x 10'	3	2 1/2" DBH	105
DECIDUOUS SHRUBS			150
Red Dogwood	5	3 gal. Cont.	15
Red Yew	7	3 gal. Cont.	21
Red Spirea	17	3 gal. Cont.	51
Red Burning Bush	20	3 gal. Cont.	60
Red Nandina	3	3 gal. Cont.	9
Red Hydrangea	14	3 gal. Cont.	42
EVERGREEN SHRUBS			44
Blue Spruce	7	3 gal. Cont.	21
Red Spruce	7	3 gal. Cont.	21
Blue Spruce	7	3 gal. Cont.	21
UPRIGHT EVERGREEN			80
Blue Spruce	9	5" DBH	80
HERBACEOUS PLANTS			120
Red Fern	60	1 gal. Cont.	60
Red Daylily	20	1 gal. Cont.	20
Red Hosta	20	1 gal. Cont.	20
Red Ornamental Grass	20	1 gal. Cont.	20
Red Iris	20	1 gal. Cont.	20
Red Sedum	20	1 gal. Cont.	20
Red Phlox	20	1 gal. Cont.	20
Red Rudbeckia	20	1 gal. Cont.	20
Red Salvia	20	1 gal. Cont.	20
Red Verbena	20	1 gal. Cont.	20
Red Zinnia	20	1 gal. Cont.	20
TOTAL PLANTS	40	40	40

Notes:
 1. Contractor shall contact Diggers Hotline prior to starting work and shall be responsible for verification of all utilities.
 2. Upon completion of the work, remove all excess materials, debris tools, and equipment from the site. Contractor shall repair any damage to plant material and lawn areas resulting from mobilization, storage or construction.
 3. Final layout and materials shall be approved by landscape architect prior to installation.
 4. Contractor shall be responsible for clean-up of all disturbed areas. Disturbed lawn areas shall be seeded. All turf areas shall be covered with Filena Erosion Netting.
 5. See specifications for additional notes.
 6. Existing plants to remain will be flagged by Landscape Architect. Planting layout shall be adjusted on-site to accommodate existing plantings.
 7. All planting beds shall be mulch with 1.5" diameter washed stone over filter fabric.

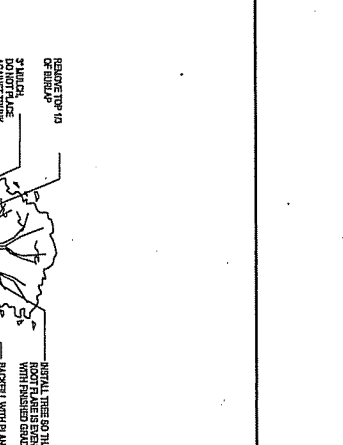
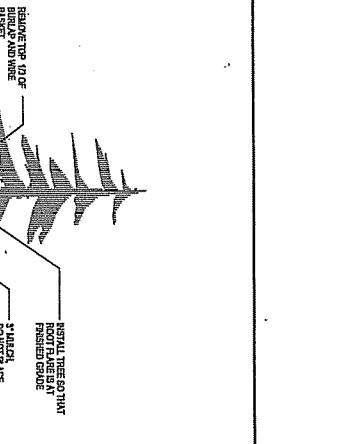
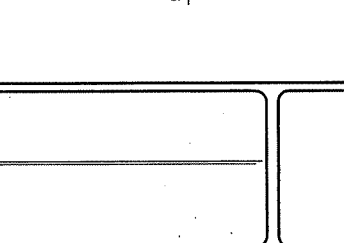
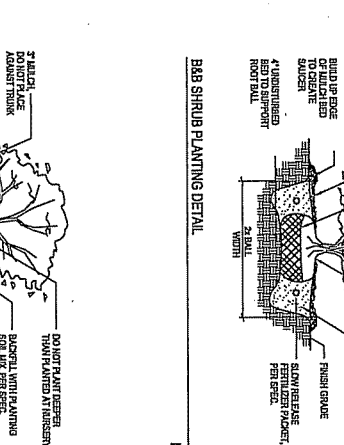
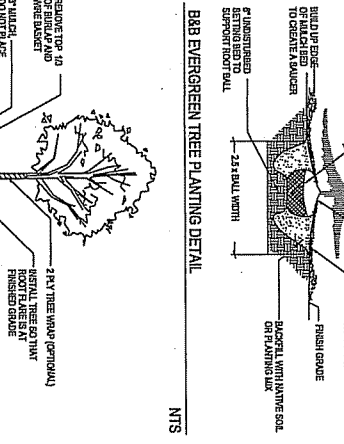
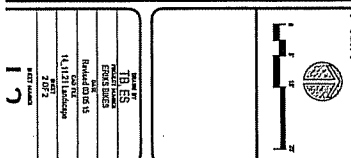
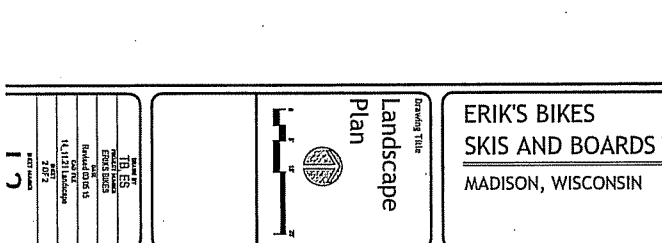
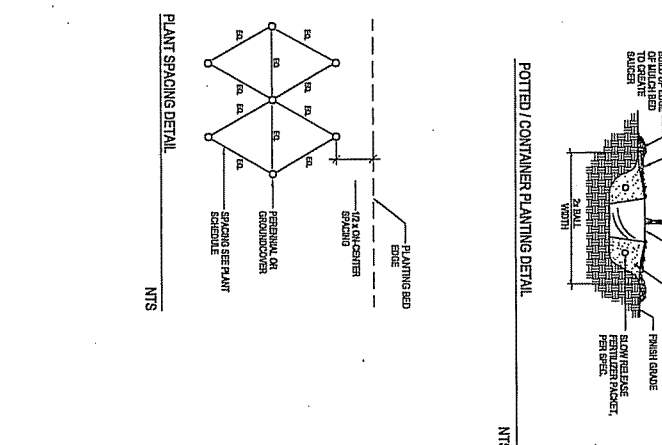
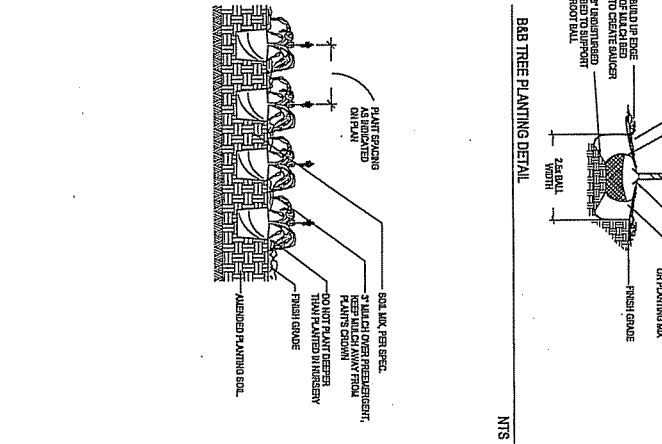
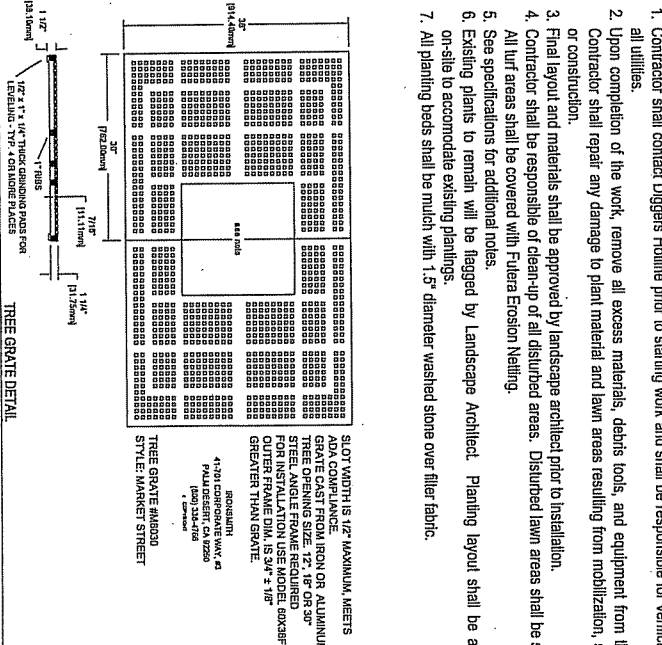

ERIK'S BIKES
 SKIS AND BOARDS
 MADISON, WISCONSIN

MCKAY
 NURSERY COMPANY
 Since 1897 - An Employee Owned Company
 PO Box 185 (7) 920.478.2121
 750 S. Monroe Street (T) 800.228.4242
 Waterloo, WI 53591 (F) 920.478.3615
 www.mckaynursery.com

Drafting Title
 Landscape
 Plan
 18-ES
 PROJECT NUMBER
 18-ES
 DRAWN BY
 11.11.21
 DATE
 2021
 13
 13



Project Description
Erik's BIKES SKIS BOARDS
January 21, 2015
Revised March 18, 2015

Project Description:

The proposed project sits on .617 acres of land formerly occupied by a single story 3,000 SF restaurant and 3 storage sheds in the 3800 block of East Washington Avenue with the nearest cross street being Mendota Street. The proposed building is a single story, 9,716 GSF multi-tenant retail building. The owner and primary tenant is to be Erik's Bikes, Boards and Skis.

A primary operational/use requirement for the facility is to allow for a SU-30 Truck to enter and exit the site during business hours. The hours of operation for Erik's are M-F 10am – 9pm, Sat. 9am – 7pm and Sunday 11am – 5pm.

Zoning:

The Property is located in the CC-T 'Commercial Corridor- Transitional' district. This district was established to recognize commercial corridors that remain largely auto-oriented, and encourage transformation into mixed-use corridors that are equally conducive to pedestrian, bicycle, transit and autos. Additionally, the property is located in a designated Urban Design District. Specifically UDD No. 5, per MGO Sec. 33.24(12).

The design solution aims at improving the quality of the landscaping, architecture and urban environment. Permitted uses include a wide range of office, retail, commercial recreation, lodging and civic uses are permitted. Specific permitted uses include - Retail sales and services: Business sales and service; sporting goods store; Food and Beverages: Coffee shop; Restaurant; Tavern. There are no minimum auto parking stalls required and 2 bike stalls required. However we are providing 19 auto parking stalls and 9 bicycle stalls. Maximum lot coverage = 85%. The lot area is 26,877 and 4,246 SF of this area(15.8%) is pervious. 980 SF is to be pervious pavers as indicated on the site plan.

Design:

The owner and primary tenant have developed a brand that is unique to them which we are looking to maintain in the architectural design. The arched endcap, red accents with a clean, more modern yet tech design sensibility while providing differentiation and massing articulation for multiple users is critical. The primary materials are, 30-32" smooth face large format cast stone base 28-34" above grade; three color ways and formats of smooth satin finish, concealed fastener Nichiha fiber cement board rain screen assembly in 18" x 3' – 6' sizes; clear anodized aluminum storefront, warm wood accents exterior wall areas, painted steel channel entry brows and architectural metal panel over building entry transoms.

The site design is largely driven by integrating the clearances and turning radius of the required delivery trucks; the placement of the building toward the primary street and the parking in the rear of the site allowing for auto traffic to enter either side of the building and circulate around the building.

Organizational Structure:

Owner: Erik Saltvold
Erik's Bikes

Architect: Iconica
901 Deming Way
Madison, WI 53717
608-664-3535
Contact: John Seamon
John.seamon@iconicacreates.com

Engineer: Iconica
901 Deming Way
Madison, WI 53717
608-664-3535
Contact: Patrick Eagan

Civil Design: JSD Professional Services, Inc.
161 Horizon Drive, Suite 101
Verona, WI 53593
Contact: Mike Grzesiak

Landscape Architect: McKay Nursery
Madison, WI 53717
608-843-0030
Contact: Eric Seidl

Signage: Graphic House
9204 Packer Drive
Wausau, WI 54401
Contact: Mike Johnson
715.842.0402

Project Schedule: Construction Start – Spring 2015.
Estimated Value of land: \$190,000.00
Estimated Project Cost: \$1,100,000.00
Public Subsidy Requested: None
Number of Construction and Full time Equivalent Jobs Created: 45

Thank you for your time in reviewing our proposal.

Sincerely,

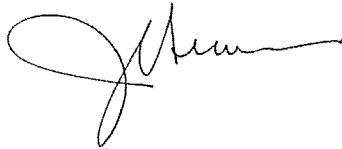

John Seamon
Architectural Director
Iconica

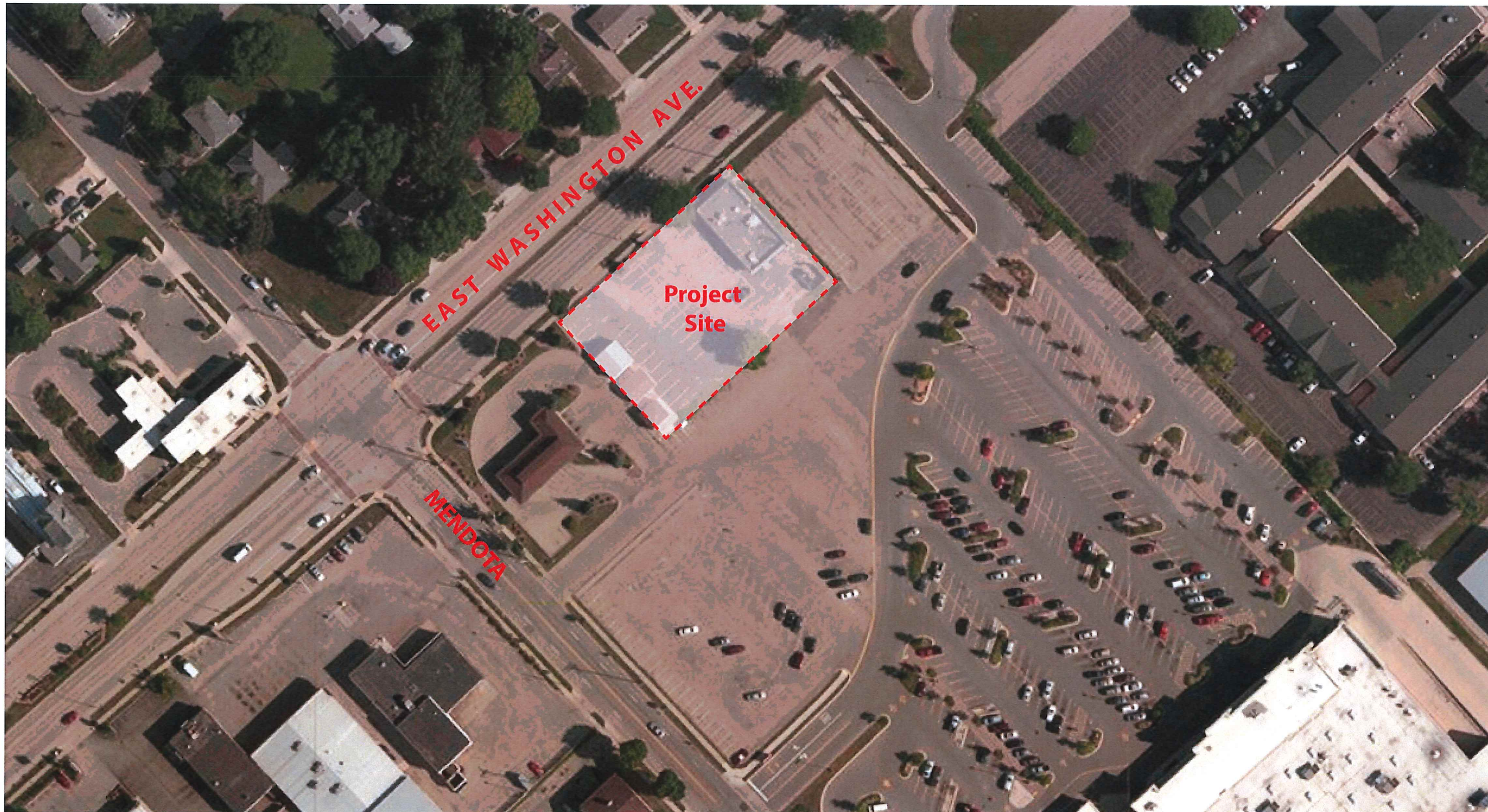

Locator Map



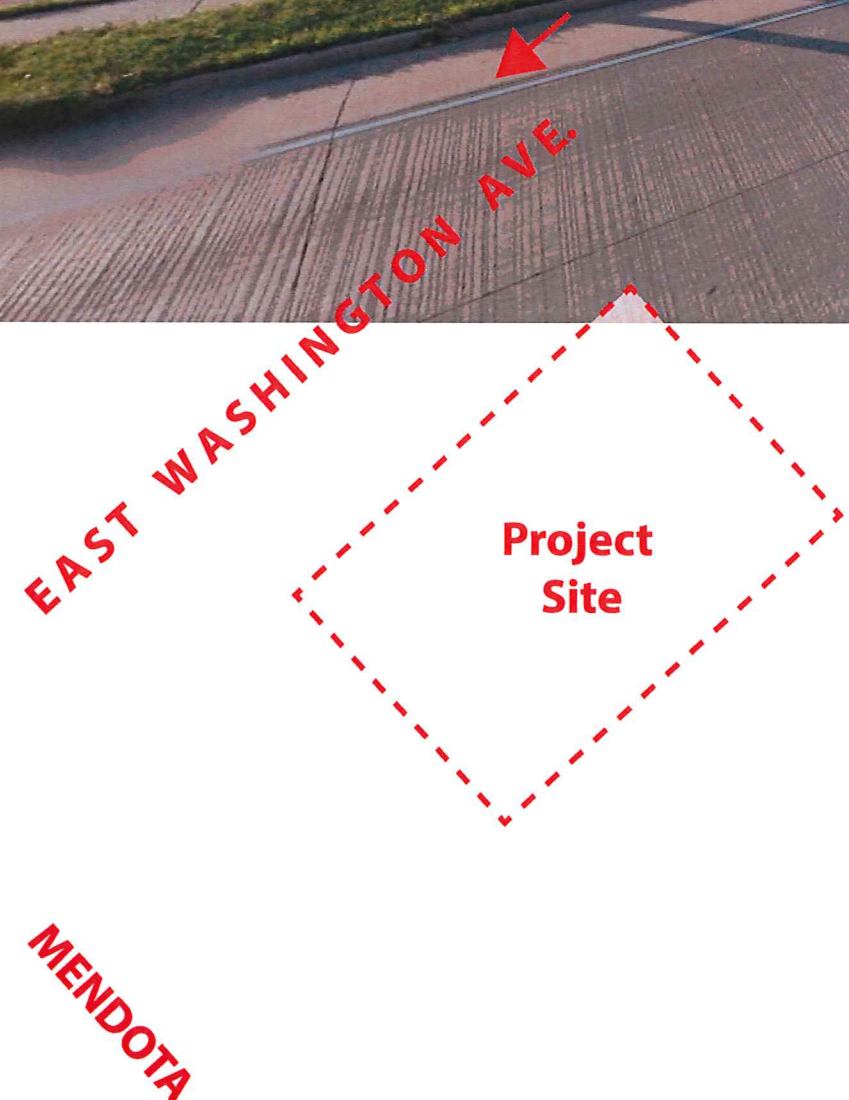

Context Photo
Looking South-West #1





EAST WASHINGTON AVE.

Project Site

MENDOTA

Context Photo
Looking South-West #2





EAST WASHINGTON AVE

Project Site

MENDOTA

Context Photo
Looking North - East





EAST WASHINGTON AVE.

Project Site

MENDOTA

Context Photo
Looking South





Storage buildings



Deli photo #1



Deli interior photo



Deli photo #2



Deli photo #3



Deli photo #4

Buildings To Be Demolished



"BUILDING RELATIONSHIPS WITH A COMMITMENT TO CLIENT SATISFACTION THROUGH TRUST, QUALITY AND EXPERIENCE"

- CIVIL ENGINEERING
- SURVEYING & MAPPING
- CONSTRUCTION SERVICES
- WATER RESOURCES
- PLANNING & DEVELOPMENT
- TRANSPORTATION ENGINEERING
- STRUCTURAL ENGINEERING
- LANDSCAPE ARCHITECTURE

MADISON REGIONAL OFFICE
 161 HORIZON DRIVE, SUITE 101
 VERONA, WISCONSIN 53593
 608.848.5060 PHONE | 608.848.2255 FAX

MADISON | MILWAUKEE
 KENOSHA | APPLETON
 www.jsdinc.com

SERVICES PROVIDED TO:

ICONICA
 901 DEMING WAY
 MADISON, WI 53717

PROJECT:

ERIK'S BIKE SHOP

PROJECT LOCATION:
 CITY OF MADISON
 DANE COUNTY, WI

JSD PROJECT NO.: 14-6475

SEAL/SIGNATURE:

ALTHOUGH EVERY EFFORT HAS BEEN MADE IN PREPARING THESE PLANS AND CHECKING THEM FOR ACCURACY, THE CONTRACTOR AND SUBCONTRACTORS MUST CHECK ALL DETAIL AND DIMENSIONS OF THEIR TRADE AND BE RESPONSIBLE FOR THE SAME.

DESIGN:	
DRAWN: JK	10-20-14
APPROVED: TJB	10-21-14

PLAN MODIFICATIONS:	DATE:

DIGGERS HOTLINE
 Call 811 or (800) 242-8511
 Milwaukee Area (262) 432-7910
 Hearing Impaired TDD (800) 542-2289
 www.DiggersHotline.com

SHEET TITLE:
**BOUNDARY,
 TOPOGRAPHIC,
 AND UTILITY SURVEY**

MAP NO.: C-374

SHEET NUMBER:

1

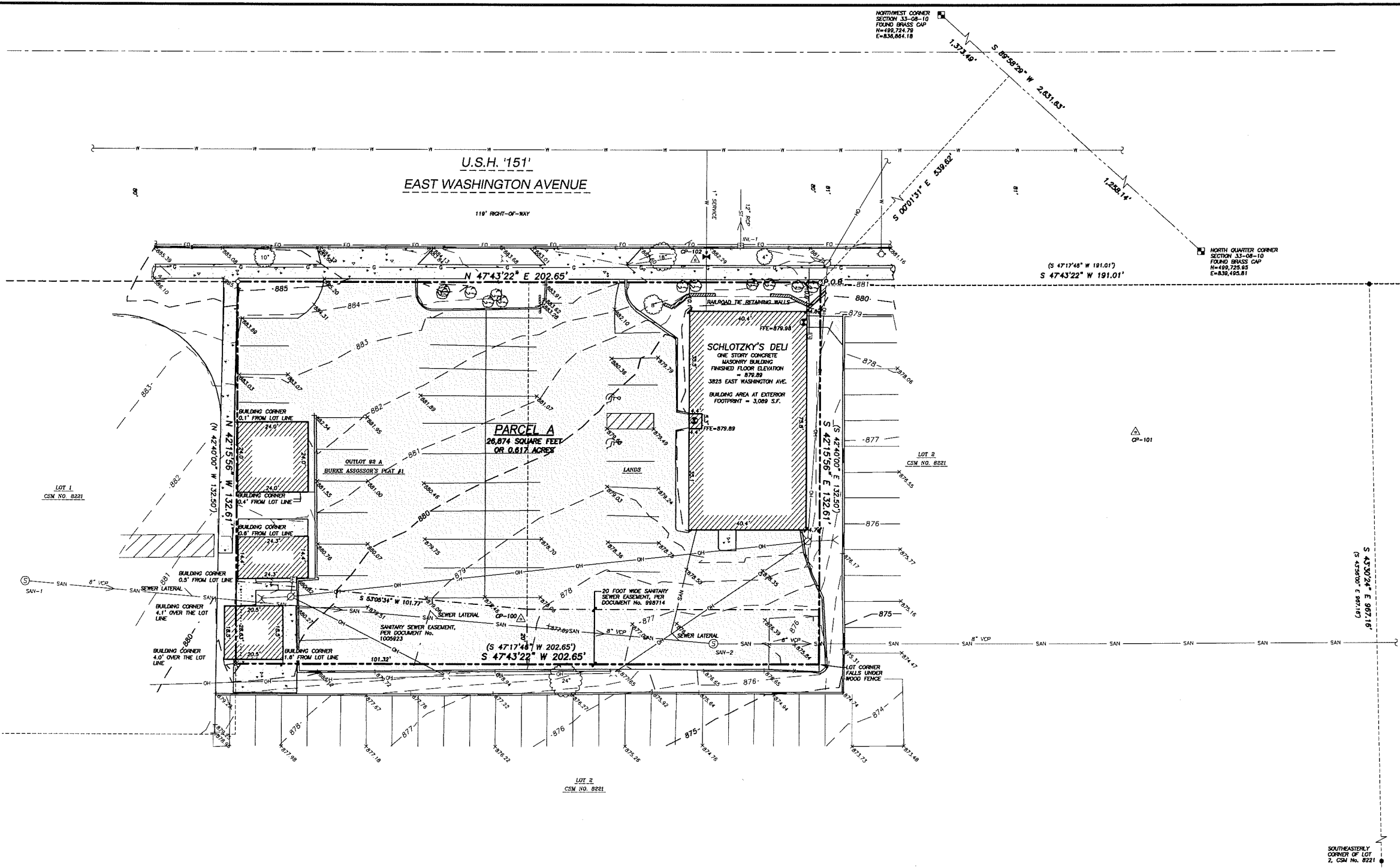

- LEGEND**
- GOVERNMENT CORNER
 - 3/4" REBAR FOUND
 - CHISELED "X" FOUND
 - 3/4" x 24" REBAR SET (1.50 LBS/LF)
 - △ CONTROL POINT
 - BENCHMARK
 - FINISHED FLOOR SHOT LOCATION
 - SIGN
 - SANITARY MANHOLE
 - HYDRANT
 - WATER OR GAS VALVE
 - CURB INLET
 - GAS REGULATOR/METER
 - POWER POLE W/GUY
 - LIGHT POLE
 - DECIDUOUS TREE
 - BUSH
 - HANDICAP PARKING
 - SECTION LINE
 - PARCEL BOUNDARY
 - PLATTED LOT LINE
 - RIGHT-OF-WAY LINE
 - CENTERLINE
 - EASEMENT LINE
 - x-x- FENCE LINE
 - GUARD OR SAFETY RAIL
 - EDGE OF PAVEMENT
 - CONCRETE CURB & GUTTER
 - EDGE OF GRAVEL
 - SAN- SANITARY SEWER
 - W- WATER LINE
 - ST- STORM SEWER
 - G- NATURAL GAS
 - OH- OVERHEAD ELECTRIC DISTRIBUTION
 - FO- FIBER OPTIC
 - ▨ BUILDING
 - B75- INDEX CONTOUR
 - B74- INTERMEDIATE CONTOUR
 - SPOT ELEVATION
 - ▨ BITUMINOUS PAVEMENT
 - ▨ RETAINING WALL
 - ▨ CONCRETE PAVEMENT
 - ▨ GRAVEL
 - ~ DISCONTINUED MAPPED PIPE LINE
 - () DENOTES RECORD DATA DEPICTING THE SAME LINE ON THE GROUND AS RETRACED BY THIS SURVEY

STRUCT. ID	RIM ELEVATION	INVERT ELEVATION	PIPE SIZE	PIPE TYPE
SAN-1	883.42	SW 873.42	8"	VCP
		NW 873.72	6"	VCP
SAN-2	876.11	NE 873.37	8"	VCP
		SW 866.93	8"	VCP
		NE 866.76	8"	VCP

INLET ID	RIM ELEVATION	INVERT ELEVATION	PIPE SIZE	PIPE TYPE
INL-1	881.58	NW 876.98	12"	RCP

CONTROL POINT	NORTHING	EASTING	ELEVATION	DESCRIPTION
CP-100	499,029.617	838,240.025	878.15	MAG NAIL
CP-101	499,220.823	838,353.958	877.30	MAG NAIL
CP-102	499,162.197	838,200.432	882.59	NAIL

*JSD DOES NOT GUARANTEE THAT THE CONTROL POINT ELEVATIONS LISTED ON THIS MAP HAVE BEEN DISTURBED SINCE THE DATE OF SURVEY. THEY SHOULD BE VERIFIED PRIOR TO CONSTRUCTION ACTIVITIES.

NOTES

- FIELD WORK PERFORMED BY JSD PROFESSIONAL SERVICES, INC. ON OCTOBER 17, 2014.
- BEARINGS FOR THIS SURVEY AND MAP ARE BASED ON THE WISCONSIN COUNTY COORDINATE SYSTEM, (WCCS), DANE COUNTY. THE NORTH LINE OF THE NORTHWEST QUARTER BEARS S 89°58'29" W.
- ELEVATIONS ARE BASED ON THE NORTH AMERICAN VERTICAL DATUM OF 1988 (NAVD88). BENCHMARK IS AN ALUMINUM CAP MARKING THE NORTHWEST CORNER OF SECTION 33, T08N, R10E, ELEVATION = 865.54'
- CONTOUR INTERVAL IS ONE FOOT.
- SPOT ELEVATIONS SHOWN ALONG CURB AND GUTTER REFERENCE THE TOP BACK OF CURB.
- SUBSURFACE UTILITIES AND FEATURES SHOWN ON THIS MAP HAVE BEEN APPROXIMATED BY LOCATING SURFICIAL FEATURES AND APPURTENANCES, LOCATING DIGGERS HOTLINE FIELD MARKINGS AND BY REFERENCE TO UTILITY RECORDS AND MAPS. DIGGER'S HOTLINE TICKET NO. 20144203488 AND 20144203496, WITH A CLEAR DATE OF OCTOBER 17, 2014.
- BEFORE EXCAVATION, APPROPRIATE UTILITY COMPANIES SHOULD BE CONTACTED. FOR EXACT LOCATION OF UNDERGROUND UTILITIES, CONTACT DIGGERS HOTLINE, AT 1.800.242.8511.
- THE ACCURACY OF THE BENCHMARKS SHOWN ON THIS MAP SHALL BE VERIFIED BEFORE BEING UTILIZED. JSD PROFESSIONAL SERVICES, INC. DOES NOT WARRANT THE ACCURACY OF THESE BENCHMARKS.
- THIS PARCEL IS ZONED CC-T, PER THE CITY OF MADISON ZONING MAP DATED JANUARY 2013.
- THIS PARCEL IS SUBJECT TO ALL EASEMENTS AND AGREEMENTS, BOTH RECORDED AND UNRECORDED.

LEGAL DESCRIPTION AS SURVEYED

PART OF OUTLOT 92 A, BURKE ASSESSOR'S PLAT #1, AND PART OF THE NORTHEAST QUARTER OF THE NORTHWEST QUARTER AND THE NORTHWEST QUARTER OF THE NORTHWEST QUARTER OF SECTION 33, TOWNSHIP 08 NORTH, RANGE 10 EAST, CITY OF MADISON, DANE COUNTY, WISCONSIN, MORE PARTICULARLY DESCRIBED AS FOLLOWS:
 COMMENCING AT THE NORTH QUARTER OF SECTION 33, AFORESAID; THENCE SOUTH 89 DEGREES 58 MINUTES 29 SECONDS WEST ALONG THE NORTH LINE OF THE NORTHWEST QUARTER OF SAID SECTION 33 A DISTANCE OF 1,258.14 FEET; THENCE SOUTH 00 DEGREES 01 MINUTES 31 SECONDS EAST, 539.62 FEET TO THE SOUTHEASTERLY RIGHT-OF-WAY LINE OF EAST WASHINGTON AVENUE (U.S.H. '151') AND THE POINT OF BEGINNING; THENCE SOUTH 42 DEGREES 15 MINUTES 56 SECONDS EAST, 132.61 FEET; THENCE SOUTH 47 DEGREES 43 MINUTES 22 SECONDS WEST, 202.65 FEET; THENCE NORTH 42 DEGREES 15 MINUTES 56 SECONDS WEST, 132.61 FEET TO THE SOUTHEASTERLY RIGHT-OF-WAY LINE OF EAST WASHINGTON AVENUE; THENCE NORTH 47 DEGREES 43 MINUTES 22 SECONDS EAST ALONG SAID RIGHT-OF-WAY LINE, 202.65 FEET TO THE POINT OF BEGINNING.

SAID PARCEL CONTAINS 26,874 SQUARE FEET OF 0.617 ACRES.

SURVEYOR'S CERTIFICATE

I, JOHN KREBS, WISCONSIN REGISTERED LAND SURVEYOR NO. S-1878, HEREBY CERTIFY THAT THIS BOUNDARY, TOPOGRAPHIC AND UTILITY SURVEY AND MAP IS CORRECT TO THE BEST OF MY KNOWLEDGE AND BELIEF IN ACCORDANCE WITH THE INFORMATION PROVIDED.

JOHN KREBS, S-1878
 PROFESSIONAL LAND SURVEYOR
 DATE

TO OBTAIN LOCATIONS OF PARTICIPANT UNDERGROUND UTILITIES BEFORE YOU DIG IN WISCONSIN

CALL DIGGERS HOTLINE
 1-800-242-8511 TOLL FREE
 WISCONSIN STATE LICENSE #48217(2014) REQUIRED MINIMUM THREE (3) WORK DAYS NOTICE BEFORE YOU EXCAVATE

THE INFORMATION SHOWN ON THIS DRAWING CONCERNING THE TYPE AND LOCATION OF UNDERGROUND UTILITIES IS NOT GUARANTEED TO BE ACCURATE OR ALL INCLUSIVE. THE CONTRACTOR IS RESPONSIBLE FOR MAKING THE CONTRACTOR'S OWN DETERMINATIONS AS TO THE TYPE AND LOCATION OF UNDERGROUND UTILITIES AS MAY BE NECESSARY TO AVOID DAMAGE THEREOF.

north

SCALE IN FEET
 20' 0 20'

File: I:\2014\146475-5\DWG\146475-Evac.dwg User: jk Plotted: Oct 23, 2014 11:40am Xref's:

THESE PLANS AND DESIGNS ARE COPYRIGHT PROTECTED AND MAY NOT BE USED IN WHOLE OR IN PART WITHOUT THE WRITTEN CONSENT OF JSD PROFESSIONAL SERVICES, INC.

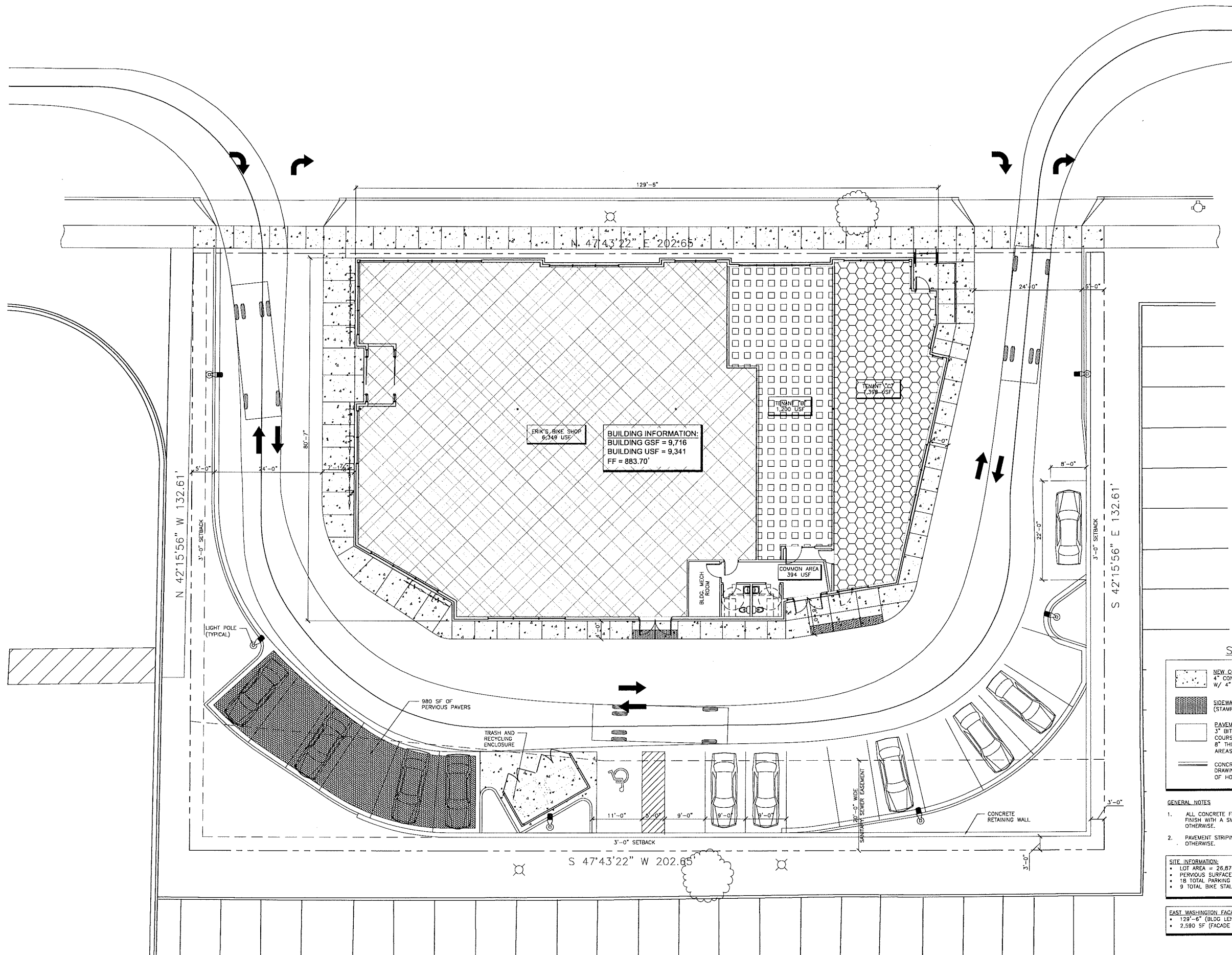

BUILDING INFORMATION:
 BUILDING GSF = 9,716
 BUILDING USF = 9,341
 FF = 883.70'

ERIK'S BIKE SHOP
 6,348 USF

TENANT 101
 1,200 USF

TENANT 102
 1,398 USF

BLDG. MECH. ROOM

COMMON AREA
 394 USF

980 SF OF PERVIOUS PAVERS

TRASH AND RECYCLING ENCLOSURE

CONCRETE RETAINING WALL

SITE LEGEND

- NEW CONCRETE FLATWORK:
 4" CONCRETE AT SIDEWALKS
 W/ 4" COMPACTED SUBBASE
- SIDEWALK RAMP:
 (STAMPED DETECTABLE WARNING GRID)
- PAVEMENT DESIGN:
 3" BITUMINOUS PAVING (1-1/2" SURFACE COURSE AND 1-1/2" BINDER COURSE) OVER 8" THICK LIMESTONE BASE AT PARKING AREAS AND 10" THICK BASE AT DRIVE AISLES
- CONCRETE CURB AND GUTTER (SEE CIVIL SITE DRAWINGS FOR CURB DETAILS AND LOCATION OF HOLDING AND REJECT CURBS)

- GENERAL NOTES**
- ALL CONCRETE FLATWORK SHALL RECEIVE A LIGHT BROOM FINISH WITH A SMOOTH WESTERN EDGE, UNLESS NOTED OTHERWISE.
 - PAVEMENT STRIPING SHALL BE YELLOW, UNLESS NOTED OTHERWISE.

SITE INFORMATION:

- LOT AREA = 26,874 SF / 0.617 ACRES
- PERVIOUS SURFACE AREA = 4,246 SF (15.8%)
- 18 TOTAL PARKING STALLS
- 9 TOTAL BIKE STALLS

EAST WASHINGTON FACADE GLAZING REQUIREMENTS:

- 129'-5" (BLDG LENGTH) x 60'-7 1/2" LF (87'-2 1/2" LF PROVIDED)
- 2,590 SF (FACADE AREA) x 40% = 1,036 SF (1,046 SF PROVIDED)

1 SITE PLAN
 SCALE: 1" = 10'-0"



901 Deming Way // Madison, WI 53717
 Ph: 608 664 3500 // Fax: 608 664 3535
 iconicacreates.com

ERIK'S BIKE SHOP
 3825 EAST WASHINGTON AVENUE
 MADISON, WISCONSIN 53704

ERIK'S - BIKE-BOARD-SKI
 9201 PENN AVE SOUTH #1
 BLOOMINGTON, MN 55431

ISSUE DATES:

RF/ISI DATE:

This document contains confidential or proprietary information of Iconica. Neither the document nor the information herein is to be reproduced, distributed, used or disclosed, either in whole or in part, except as specifically authorized by Iconica.

PROJECT #: 20140810
 SHEET NUMBER

A100

LEGEND (PROPOSED)

--- PROPERTY LINE
 --- 889 PROPOSED 1 FOOT CONTOUR
 --- 870 PROPOSED 5 FOOT CONTOUR

==== REJECT CURB AND GUTTER
 --- ASPHALTIC PAVEMENT
 --- CONCRETE PAVEMENT
 --- SILT FENCE
 --- SPOT ELEVATION
 BC - BACK OF CURB
 EC - EDGE OF PAVEMENT
 RM - STRUCTURE RIM
 EC - EDGE OF CONCRETE
 FG - FINAL GRADE
 HP - HIGH POINT
 SW - SIDEWALK
 TW - TOP OF WALL
 BW - BOTTOM OF WALL

JSD Professional Services, Inc.
 Engineers • Surveyors • Planners

"BUILDING RELATIONSHIPS WITH A COMMITMENT TO CLIENT SATISFACTION THROUGH TRUST, QUALITY AND EXPERIENCE"

MADISON REGIONAL OFFICE
 161 HORIZON DRIVE, SUITE 101
 VERONA, WISCONSIN 53593
 608.848.5060 PHONE | 608.848.2255 FAX

JSD Professional Services, Inc.
 Engineers • Surveyors • Planners

"BUILDING RELATIONSHIPS WITH A COMMITMENT TO CLIENT SATISFACTION THROUGH TRUST, QUALITY AND EXPERIENCE"

- CIVIL ENGINEERING
- SURVEYING & MAPPING
- CONSTRUCTION SERVICES
- WATER RESOURCES
- PLANNING & DEVELOPMENT
- TRANSPORTATION ENGINEERING
- STRUCTURAL ENGINEERING
- LANDSCAPE ARCHITECTURE

MADISON REGIONAL OFFICE
 161 HORIZON DRIVE, SUITE 101
 VERONA, WISCONSIN 53593
 608.848.5060 PHONE | 608.848.2255 FAX

MADISON | MILWAUKEE
 KENOSHA | APPLETON
 www.jsdinc.com

GENERAL NOTES

- REFER TO THE BOUNDARY, TOPOGRAPHIC AND UTILITY SURVEY DATED 10-17-2014 AND FOR EXISTING CONDITIONS, NOTES AND LEGEND.
- ALL WORK IN THE ROW SHALL BE IN ACCORDANCE WITH MSDOT STANDARD SPECIFICATIONS FOR HIGHWAY AND STRUCTURE CONSTRUCTION, LATEST EDITION.
- JSD SHALL BE HELD HARMLESS AND DOES NOT WARRANT ANY DEVIATIONS BY THE OWNER/CONTRACTOR FROM THE APPROVED CONSTRUCTION PLANS THAT MAY RESULT IN DISCIPLINARY ACTIONS BY ANY OR ALL REGULATORY AGENCIES.
- DRAWING FOR REVIEW - NOT FOR CONSTRUCTION UNLESS OTHERWISE NOTED IN THE TITLE BLOCK.

CONSTRUCTION SITE EROSION CONTROL REQUIREMENTS

- ALL EROSION AND SEDIMENT CONTROL PRACTICES SHALL BE DESIGNED AND IMPLEMENTED IN ACCORDANCE WITH THE CURRENT DEPARTMENT OF NATURAL RESOURCES EROSION AND SEDIMENT CONTROL TECHNICAL STANDARDS WHICH ARE AVAILABLE AT: <http://www.dnr.state.wi.us/runoff/stormwater/techstds.htm>
- INSTALL EROSION CONTROL MEASURES PRIOR TO ANY SITE WORK, INCLUDING GRADING OR DISTURBANCE OF EXISTING SURFACE MATERIALS AS SHOWN ON PLAN. MODIFICATIONS TO SEDIMENT CONTROL DESIGN MAY BE CONDUCTED TO MEET UNPREDICTED FIELD CONDITIONS IF MODIFICATIONS CONFORM TO MNR TECHNICAL STANDARDS.
- INSPECTIONS AND MAINTENANCE OF ALL EROSION CONTROL MEASURES SHALL BE ROUTINE (ONCE PER WEEK MINIMUM) TO ENSURE PROPER FUNCTION OF EROSION CONTROLS AT ALL TIMES. EROSION CONTROL MEASURES ARE TO BE IN WORKING ORDER AT THE END OF EACH WORK DAY. ONLINE REPORTING OF INSPECTIONS AND MAINTENANCE IS REQUIRED TO BE SUBMITTED TO THE CITY OF MADISON.
- INSPECT EROSION CONTROL MEASURES AFTER EACH 1/2" OR GREATER RAINFALL. REPAIR ANY DAMAGE OBSERVED DURING THE INSPECTION.
- EROSION CONTROL MEASURES SHALL BE REMOVED ONLY AFTER SITE CONSTRUCTION IS COMPLETE WITH ALL SOIL SURFACES HAVING AN ESTABLISHED VEGETATIVE COVER.
- INSTALL A TRACKING PAD, 50' LONG AND NO LESS THAN 12" THICK BY USE OF 3" CLEAR STONE. TRACKING PADS ARE TO BE MAINTAINED BY THE CONTRACTOR IN A CONDITION WHICH WILL PREVENT THE TRACKING OF MUD OR DRY SEDIMENT ONTO THE ADJACENT PUBLIC STREETS AFTER EACH WORKING DAY OR MORE FREQUENTLY AS REQUIRED BY THE CITY OF MADISON.
- INSTALL EROSION CONTROLS ON THE DOWNSTREAM SIDE OF STOCKPILES AND PROVIDE TEMPORARY SEEDING ON STOCKPILES WHICH ARE TO REMAIN IN PLACE FOR MORE THAN 7 DAYS.
- INSTALL CHECK DAMS WITHIN DRAINAGE DIVIDES AND IN FRONT OF SILT FENCING IN ANY LOW AREA ALL IN ACCORDANCE WITH MNR TECHNICAL STANDARDS.
- EROSION CONTROL FOR UTILITY CONSTRUCTION (STORM SEWER, SANITARY SEWER, WATER MAIN, ETC.):
 A. PLACE EXCAVATED FRENCH MATERIAL ON THE HIGH SIDE OF THE FRENCH.
 B. BACKFILL, COMPACT, AND STABILIZE THE FRENCH IMMEDIATELY AFTER PIPE CONSTRUCTION. DISCHARGE FRENCH WATER INTO A SEDIMENTATION BASIN OR FILTERING TANK IN ACCORDANCE WITH THE DEWATERING TECHNICAL STANDARD NO. 1061 PRIOR TO RELEASE INTO THE STORM SEWER, RECEIVING STREAM, OR DRAINAGE DITCH.
- INSTALL TYPE D INLET PROTECTION AROUND ALL STORM SEWER INLETS AND CATCH BASINS THAT MAY RECEIVE RUNOFF FROM AREAS UNDER CONSTRUCTION. REFER TO MSDOT FDM FOR RESPECTIVE DETAILS.
- APPLY ANIONIC POLYMER TO DISTURBED AREAS IF EROSION BECOMES PROBLEMATIC.
- ADDITIONAL EROSION CONTROL MEASURES, AS REQUESTED BY STATE INSPECTORS, LOCAL INSPECTORS, AND/OR ENGINEER SHALL BE INSTALLED WITHIN 24 HOURS OF REQUEST.
- ALL SLOPES EXCEEDING 5:1 (20%) SHALL BE STABILIZED WITH A CLASS II, TYPE B EROSION MATTING AND DRAINAGE SWALES SHALL BE STABILIZED WITH CLASS I, TYPE B EROSION MATTING OR APPLICATION OF A WOOD APPROVED POLYMER SOIL STABILIZATION TREATMENT OR A COMBINATION THEREOF, AS REQUIRED. CONTRACTOR SHALL PROVIDE PRODUCT SPECIFICATIONS TO PROJECT ENGINEER FOR APPROVAL.
- CONTRACTOR/OOWNER SHALL FILE A NOTICE OF TERMINATION UPON VEGETATIVE STABILIZATION AND/OR PROPERTY SALE IN ACCORDANCE WITH MNR REQUIREMENTS.
- CONTRACTOR SHALL TAKE ALL NECESSARY STEPS TO CONTROL DUST ARISING FROM CONSTRUCTION OPERATIONS. REFER TO MNR TECHNICAL STANDARD 1068.
- CONTRACTOR TO PROVIDE SEALED OR SOLID LID, OR FILTER BAGS ON ALL OPEN MANHOLES DURING CONSTRUCTION TO MINIMIZE SEDIMENT FROM ENTERING THE STORM SEWER SYSTEM.
- BUILDING AND WASTE MATERIAL SHALL BE HANDLED TO PREVENT RUNOFF OF MATERIAL INTO WATERS OF THE STATE.
- NO SOLID MATERIAL IS DISCHARGED IN VIOLATION OF WISCONSIN STATUTES CHAPTERS 30 OR 31, OR USC 1344 PERMITS.
- SHOULD GRANULAR SOIL SEAMS BE ENCOUNTERED BELOW PLANNED WATER LEVELS DURING EXCAVATION OF THE POND, THESE SOILS SHALL BE OVER EXCAVATED A MINIMUM OF 2 FEET AND REPLACED WITH COMPACTED CLAY MATERIALS TO SERVE AS A PLUG.

GRADING AND SEEDING NOTES

- ALL DISTURBED AREAS SHALL BE SEEDING AND MULCHED IMMEDIATELY FOLLOWING GRADING ACTIVITIES. SEED MIX TO BE IN ACCORDANCE WITH LANDSCAPE PLAN.
- CONTRACTOR SHALL STABILIZE ANY EXPOSED SOIL SURFACES ON THE SITE WITH MULCH PRIOR TO WORK.
- ALL PROPOSED GRADES SHOWN ARE FINISHED GRADES. CONTRACTOR SHALL VERIFY ALL GRADES, MAKE SURE ALL AREAS DRAIN PROPERLY AND SHALL REPORT ANY DISCREPANCIES TO THE ENGINEER PRIOR TO CONSTRUCTION.
- CONTRACTOR SHALL PROTECT ADJACENT PROPERTIES WITH SILT FENCING FOR EROSION CONTROL UNTIL CONSTRUCTION IS COMPLETED AND NOTICE OF TERMINATION FILED.
- CONTRACTOR SHALL WATER ALL NEWLY SEEDING AREAS DURING THE SUMMER MONTHS WHENEVER THERE IS A 7 DAY LAPSE WITH NO SIGNIFICANT RAINFALL.
- CONTRACTOR TO DEEP TILL ALL COMPACTED PERVIOUS SURFACES PRIOR TO SEEDING AND MULCHING. THIS MUST BE VERIFIED BY THE ENGINEER AS PART OF THE AS-BUILT CERTIFICATION.
- THE CONTRACTOR SHALL NOTIFY THE CITY OF MADISON A MINIMUM OF TWO (2) WORKING DAYS IN ADVANCE OF ANY SOIL DISTURBING ACTIVITY.

U.S.H. 151
 EAST WASHINGTON AVE

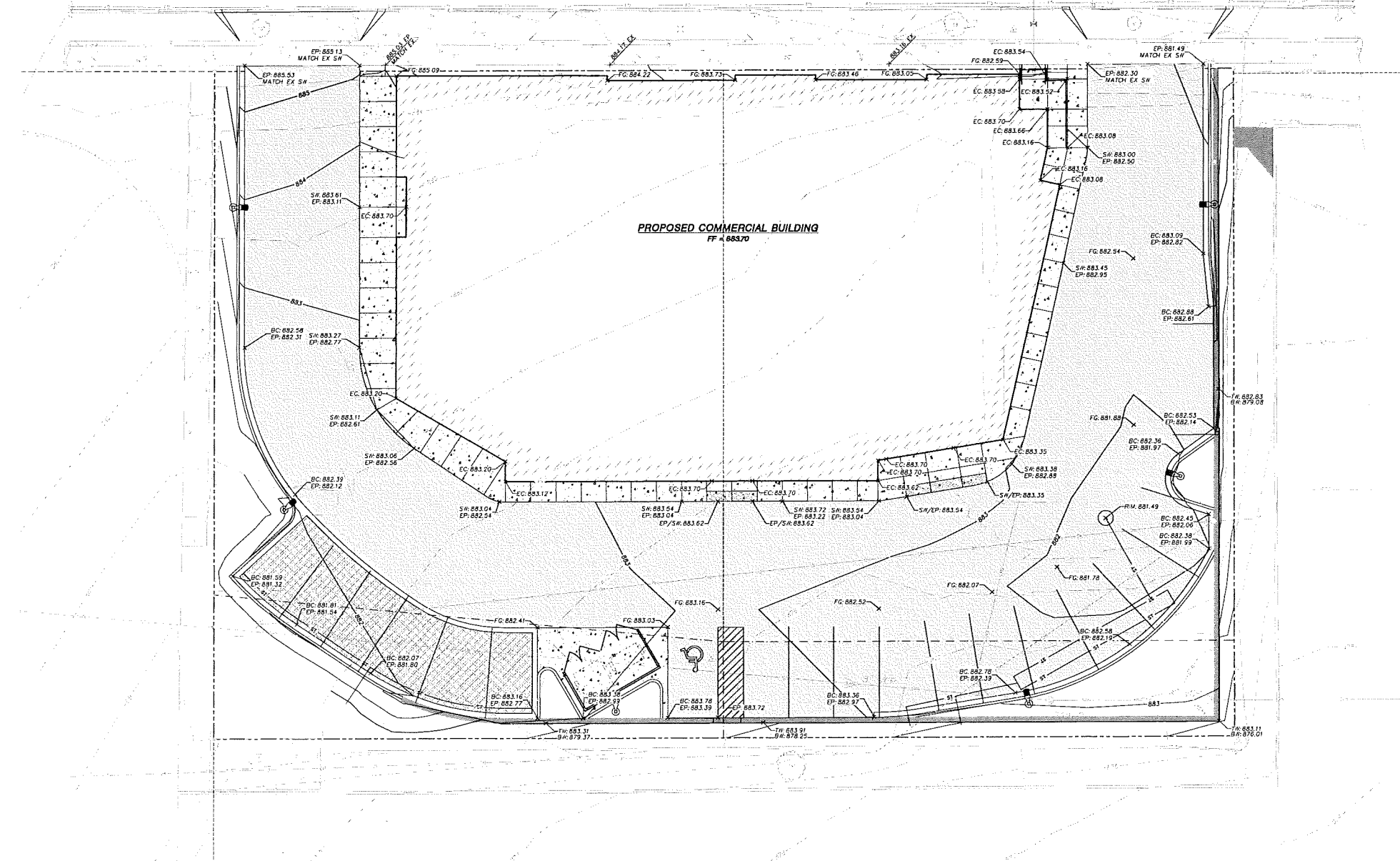

SERVICES PROVIDED TO:
 ICONICA

PROJECT LOCATION:
 ERIK'S BIKE SHOP
 E. WASHINGTON AVE.

PROJECT LOCATION:
 CITY OF MADISON
 DANE COUNTY, WI

JSD PROJECT NO.: 14-6475

SEAL/SIGNATURE:

ALTHOUGH EVERY EFFORT HAS BEEN MADE IN PREPARING THESE PLANS AND CHECKING THEM FOR ACCURACY, THE CONTRACTOR AND SUBCONTRACTORS MUST CHECK ALL DETAIL AND DIMENSIONS OF THEIR TRADE AND BE RESPONSIBLE FOR THE SAME.

DESIGN:	1/20	3/17/15
DRAWN:	1/20	3/17/15
APPROVED:		
PLAN MODIFICATIONS:		
LOCALITY:	WTA	3/17/15

DIGGERS & HOTLINE
 Toll Free (800) 242-8511
 Milwaukee Area (414) 259-1157
 Heavy Equipment (800) 542-2288
 www.DiggerandHotline.com

SHEET TITLE:
 GRADING AND EROSION CONTROL PLAN

SHEET NUMBER:
 C-2.0

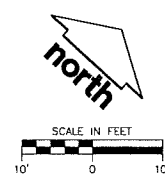

PRELIMINARY
 GRADING AND EROSION CONTROL PLAN

File: C:\2014\146475\DWG\146475-Construction-Drawings.dwg Layout: C3.0 User: mpruzanski Printed: Mar 17, 2015 4:23pm Scale:



Erik's - Multi Tenant Retail
Perspective view from East Washington
looking South East





Erik's - Multi Tenant Retail
Perspective view from East Washington
looking South West





Erik's - Multi Tenant Retail
Perspective view looking North West





Erik's - Multi Tenant Retail
Perspective view looking North East



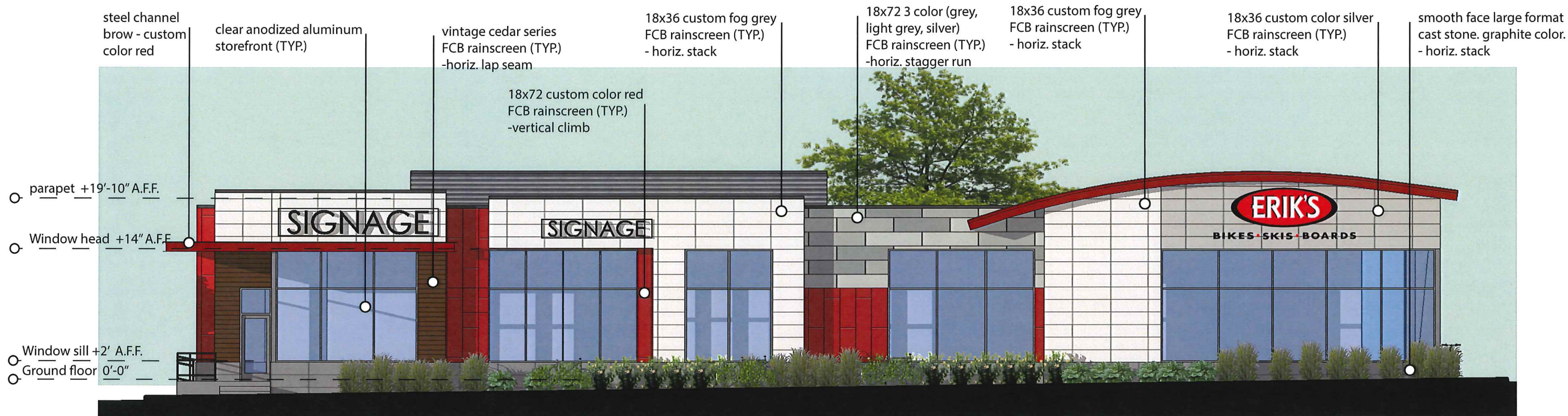

Erik's - Multi Tenant Retail
North Elevation



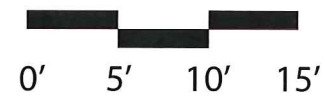

Erik's - Multi Tenant Retail West Elevation



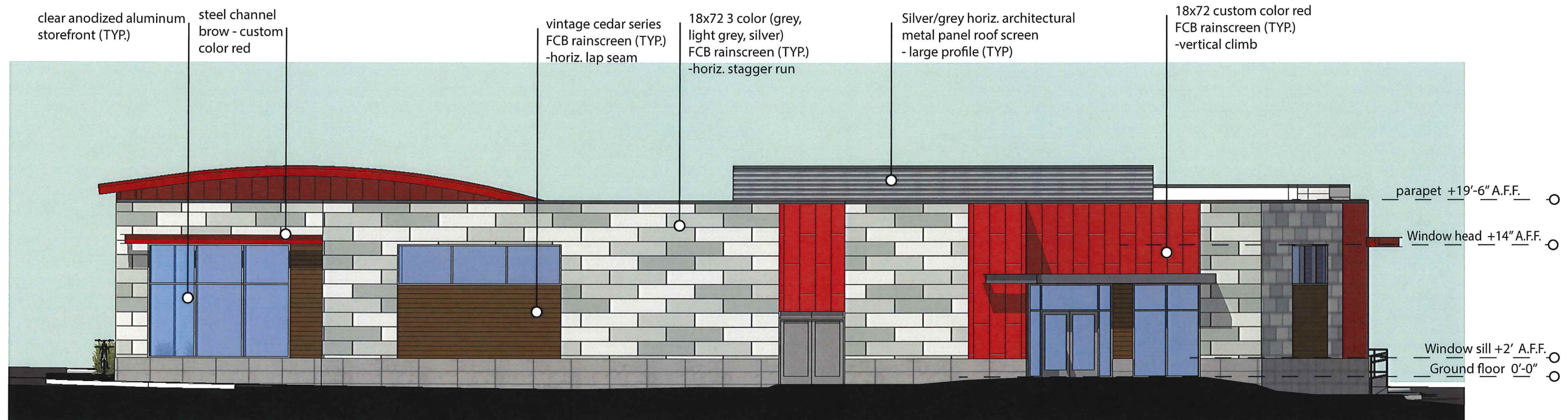

Erik's - Multi Tenant Retail South Elevation





Erik's - Multi Tenant Retail East Elevation



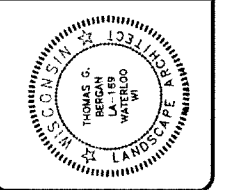

ERIK'S BIKES
SKIS AND BOARDS
 MADISON, WISCONSIN

Drawing Title
Landscape Plan

DRAWN BY
TB, ES
 PROJECT NUMBER
ERIK'S BIKES
 DATE
 Revised 03.15.15
 CAD FILE
 14_11.21 Landscape
 SHEET
 1 OF 2
 SHEET NUMBER
L1

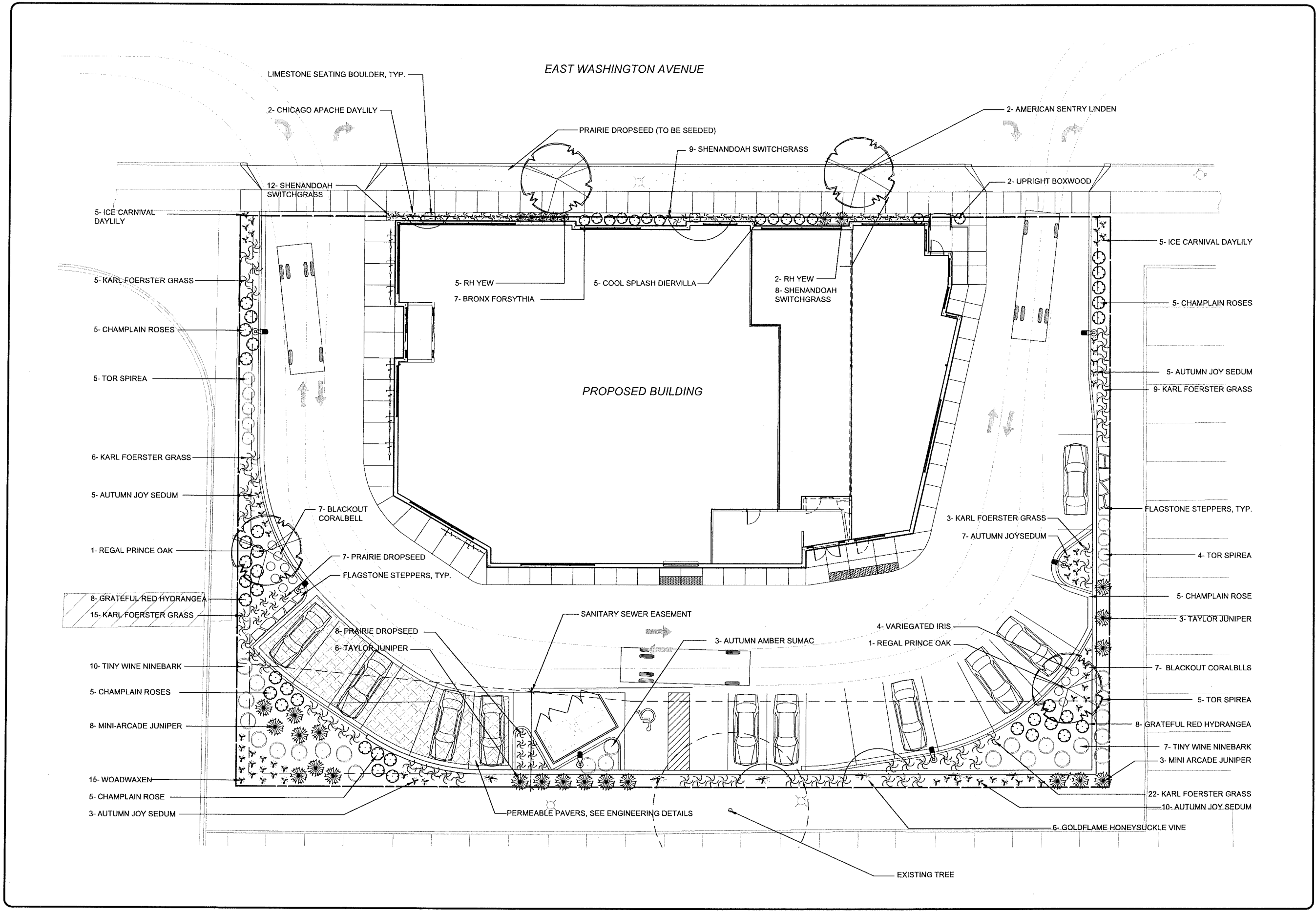

OVERALL LANDSCAPE CALCULATIONS

DEVELOPED AREA	17,156 SF
REQUIRED LANDSCAPE UNITS	58 UNITS
LANDSCAPE POINTS REQUIRED	290 POINTS
LANDSCAPE POINTS PROVIDED	965 POINTS

PLANT SCHEDULE- PROPOSED PLANTINGS

DECIDUOUS TREES				
Regal Prince Oak	<i>Quercus robur x bicolor 'Lang'</i>	Qty	Size	Points
		2	2 1/2" B&B	70
DECIDUOUS SHRUBS				
Cool Splash Diervilla	<i>Diervilla sessilifolia 'LPDC Padaras'</i>	5	3 gal. Cont.	15
Bronx Forsythia	<i>Forsythia viridissima 'Bronxensis'</i>	7	3 gal. Cont.	21
Grateful Red Hydrangea	<i>Hydrangea macrophylla 'Grateful Red'</i>	16	3 gal. Cont.	48
Little Wine Ninebark	<i>Physocarpus opulifolius 'Tiny Wine'</i>	17	3 gal. Cont.	51
Champlain Rose	<i>Rosa 'Champlain'</i>	20	3 gal. Cont.	60
Autumn Amber Sumac	<i>Rhus trilobata 'Autumn Amber'</i>	3	3 gal. Cont.	9
Birchleaf Spirea	<i>Spiraea betulifolia 'Tor'</i>	14	3 gal. Cont.	42
EVERGREEN SHRUBS				
Mini Arcade Juniper	<i>Juniperus sabina 'Mini Arcade'</i>	11	5 gal. Cont.	44
Upright Boxwood	<i>Buxus 'Green Mountain'</i>	7	5 gal. Cont.	28
RH Yew	<i>Taxus x. h 'Richard Horsey'</i>	7	5 gal. Cont.	28
UPRIGHT EVERGREEN				
Taylor Juniper	<i>Juniperus virginiana 'Taylor'</i>	9	5' B&B	90
HERBACEOUS PLANTS				
Karl Foerster Reed Grass	<i>Calamagrostis acutiflora 'Karl Foerster'</i>	60	1 gal. Cont.	120
Shenandoah Switchgrass	<i>Panicum virgatum 'Shenandoah'</i>	29	1 gal. Cont.	58
Prairie Dropseed	<i>Sporobolus heterolepis</i>	15	1 gal. Cont.	30
Goldflame Honeysuckle Vine	<i>L. x heckrottii 'Goldflame'</i>	6	1 gal. Cont.	0
Woodwaxen	<i>Genista tinctoria</i>	15	1 gal. Cont.	30
Chicago Apache Daylily	<i>Hemerocallis 'Chicago Apache'</i>	2	1 gal. Cont.	4
Ice Carnival Daylily	<i>Hemerocallis 'Ice Carnival'</i>	10	1 qt. Cont.	20
Blackout Coralbells	<i>Huechera 'Blackout'</i>	14	1 qt. Cont.	28
Variegated Iris	<i>Iris ensenata 'variegata'</i>	4	1 qt. Cont.	8
Autumn Joy Sedum	<i>Sedum x Herbstfreude</i>	20	1 gal. Cont.	40
TOTAL POINTS				936

Notes:

- Contractor shall contact Diggers Hotline prior to starting work and shall be responsible for verification of all utilities.
- Upon completion of the work, remove all excess materials, debris tools, and equipment from the site. Contractor shall repair any damage to plant material and lawn areas resulting from mobilization, storage or construction.
- Final layout and materials shall be approved by landscape architect prior to installation.
- Contractor shall be responsible of clean-up of all disturbed areas. Disturbed lawn areas shall be seeded. All turf areas shall be covered with Futera Erosion Netting.
- See specifications for additional notes.
- Existing plants to remain will be flagged by Landscape Architect. Planting layout shall be adjusted on-site to accommodate existing plantings.
- All planting beds shall be mulch with 1.5" diameter washed stone over filter fabric.

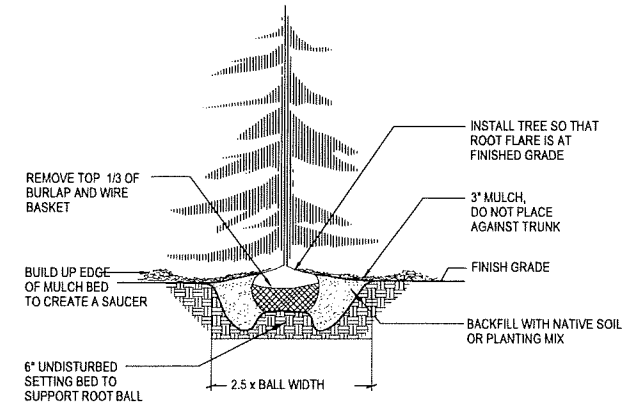

B&B EVERGREEN TREE PLANTING DETAIL

NTS

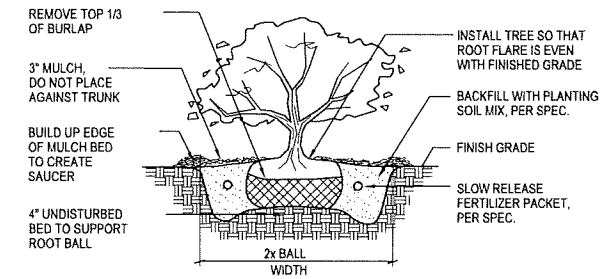

B&B SHRUB PLANTING DETAIL

NTS

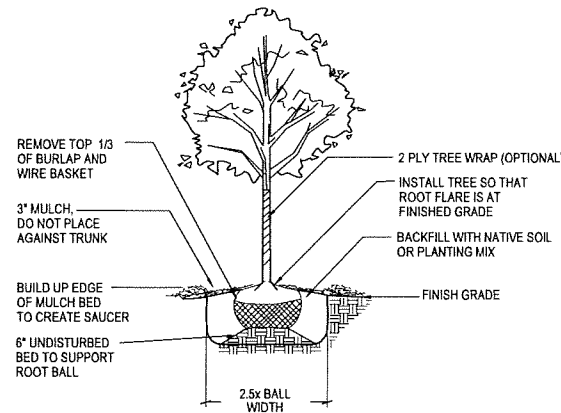

B&B TREE PLANTING DETAIL

NTS

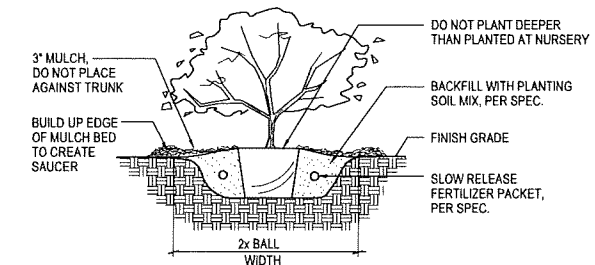

POTTED / CONTAINER PLANTING DETAIL

NTS

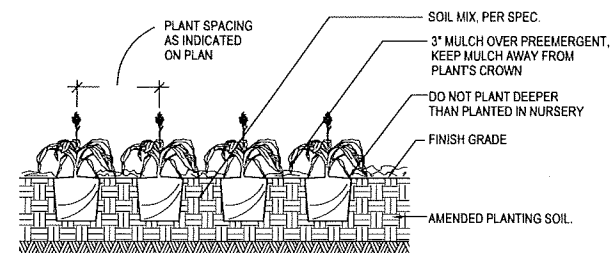

PERENNIAL / PLUG PLANTING DETAIL

NTS

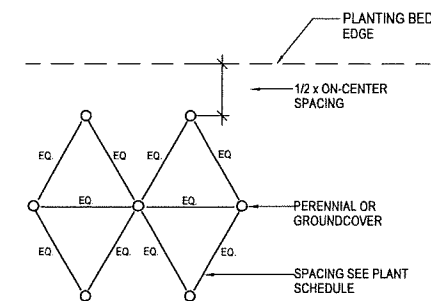

PLANT SPACING DETAIL

NTS



CITY OF MADISON LANDSCAPE WORKSHEET

Section 28.142 Madison General Ordinance

Project Location / Address 3825 E WASHINGTON
 Name of Project ERIK'S BIKES, BOARDS & SKIS
 Owner / Contact ERIK SALTVOLD
 Contact Phone 952-351-8345 Contact Email erik@eriks bikeshop.com

**** Landscape plans for zoning lots greater than ten thousand (10,000) square feet in size MUST be prepared by a registered landscape architect. ****

Applicability

The following standards apply to all exterior construction and development activity, including the expansion of existing buildings, structures and parking lots, except the construction of detached single-family and two-family dwellings and their accessory structures. The entire development site must be brought up to compliance with this section unless all of the following conditions apply, in which case only the affected areas need to be brought up to compliance:

- (a) The area of site disturbance is less than ten percent (10%) of the entire development site during any ten-(10) year period.
- (b) Gross floor area is only increased by ten percent (10%) during any ten-(10) year period.
- (c) No demolition of a principal building is involved.
- (d) Any displaced landscaping elements must be replaced on the site and shown on a revised landscaping plan.

Landscape Calculations and Distribution

Required landscaped areas shall be calculated based upon the total developed area of the property. Developed area is defined as that area within a single contiguous boundary which is made up of structures, parking, driveways and docking/loading facilities, but excluding the area of any building footprint at grade, land designated for open space uses such as athletic fields, and undeveloped land area on the same zoning lot. There are three methods for calculating landscape points depending on the size of the lot and Zoning District.

- (a) For all lots except those described in (b) and (c) below, five (5) landscape points shall be provided for each three hundred (300) square feet of developed area.

Total square footage of developed area 17,158 SF
 Total landscape points required 290

- (b) For lots larger than five (5) acres, points shall be provided at five (5) points per three hundred (300) square feet for the first five (5) developed acres, and one (1) point per one hundred (100) square feet for all additional acres.

Total square footage of developed area _____
 Five (5) acres = 217,800 square feet
 First five (5) developed acres = 3,630 points
 Remainder of developed area _____
 Total landscape points required _____

- (c) For the Industrial – Limited (IL) and Industrial – General (IG) districts, one (1) point shall be provided per one hundred (100) square feet of developed area.

Total square footage of developed area _____
 Total landscape points required _____

Tabulation of Points and Credits

Use the table to indicate the quantity and points for all existing and proposed landscape elements.

Plant Type/ Element	Minimum Size at Installation	Points	Credits/ Existing Landscaping		New/ Proposed Landscaping	
			Quantity	Points Achieved	Quantity	Points Achieved
Overstory deciduous tree	2½ inch caliper measured diameter at breast height (dbh)	35			2	70
Tall evergreen tree (i.e. pine, spruce)	5-6 feet tall	35				
Ornamental tree	1 1/2 inch caliper	15				
Upright evergreen shrub (i.e. arborvitae)	3-4 feet tall	10			9	90
Shrub, deciduous	#3 gallon container size, Min. 12"-24"	3			82	246
Shrub, evergreen	#3 gallon container size, Min. 12"-24"	4			25	100
Ornamental grasses/ perennials	#1 gallon container size, Min. 8"-18"	2			169	338
Ornamental/ decorative fencing or wall	n/a	4 per 10 lineal ft.				
Existing significant specimen tree	Minimum size: 2 ½ inch caliper dbh. *Trees must be within developed area and cannot comprise more than 30% of total required points.	14 per caliper inch dbh. Maximum points per tree: 200				
Landscape furniture for public seating and/or transit connections	* Furniture must be within developed area, publically accessible, and cannot comprise more than 5% of total required points.	5 points per "seat"				
Sub Totals				0		844

Total Number of Points Provided 844

* As determined by ANSI, ANLA- American standards for nursery stock. For each size, minimum plant sizes shall conform to the specifications as stated in the current American Standard for Nursery Stock.

SIGN SPECIFICATIONS

- (1) S/F INTERN. ILLUM. WALL SIGN
- * SIGN CABINETS ARE TO BE FORMED OF ALUM. PAINTED BLACK.
- * FACE IS TO BE WHITE POLYCARBONATE. ALL COPY IS TO BE WHITE w/ #3630-22 BLACK VINYL SHADOW & OPAQUE #8500-031 RED VINYL BACKGROUND.
- * PERFORATED METAL (.063" ALUM.) IS TO BE PAINTED BLACK & MOUNTED 1" OFF FACE OF SIGN.
- * "BIKES - SKIS - BOARDS" CABINET IS TO BE FORMED OF ALUM. PAINTED METALLIC SILVER. ALL COPY IS TO BE ROUTED OUT & BACKED w/ MILK WHITE ACRYLIC. COPY IS TO HAVE 3M DUAL COLOR PERFORATED VINYL (BLACK/WHITE). CIRCLES ARE TO HAVE #8500-031 RED VINYL. SIGN IS TO BE INTERN. ILLUM. w/ WHITE LED'S & MOUNTED FLUSH TO BUILDING.

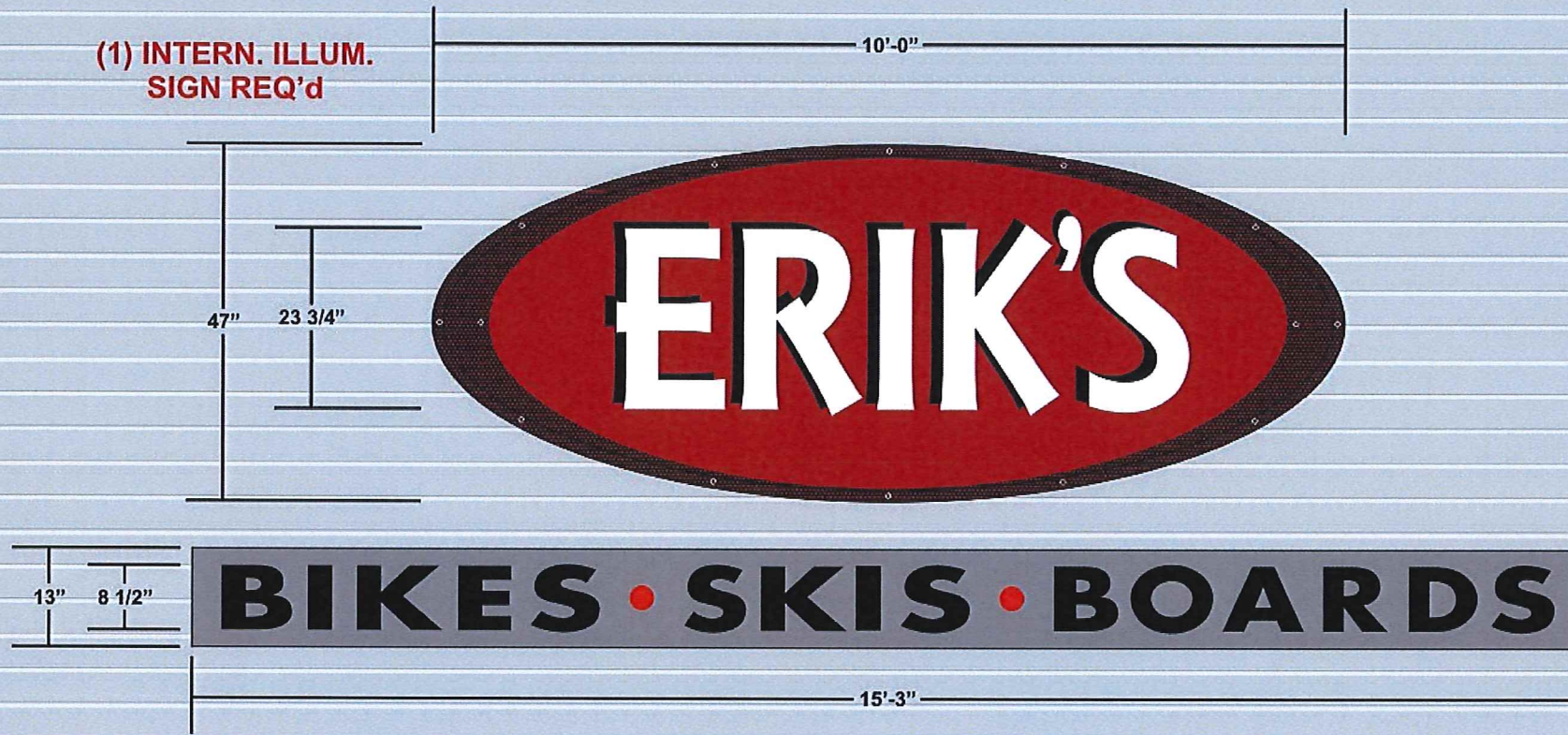

WHITE "ERIK'S" & DUAL COLOR WHITE "BIKES - SKIS - BOARDS" WILL LIGHT DIFFERENTLY AT NIGHT



"Erik's" sign - 47" x 120" = 39.2 SqFt
Secondary cabinet - 13" x 183" = 16.5 SqFt
TOTAL = 55.7 SqFt



CLIENT HAS IDENTIFIED THE LOCATION IN WHICH THE SIGNAGE IS TO BE INSTALLED. THE CLIENT HAS THE SOLE RESPONSIBILITY FOR THE STRUCTURAL INTEGRITY OF ALL EXISTING STRUCTURES TO SUPPORT THE SIGNAGE.

ALL RIGHTS RESERVED THIS IS AN ORIGINAL DESIGN CREATED BY GRAPHIC HOUSE, INCORPORATED. THE SUBMITTED DESIGN IS ORIGINAL AND PROTECTED UNDER COPYRIGHT LAWS OF THE UNITED STATES, TITLE 17 UNITED STATES CODE. YOU AGREE NOT TO COPY, PHOTOGRAPH, MODIFY OR SHARE DIRECTLY OR INDIRECTLY ANY OF THE FOREGOING HELD BY YOU WITH ANY OTHER PARTY NOR WILL YOU PERMIT ANY THIRD PARTY TO DO ANY OF THE FOREGOING WITHOUT THE WRITTEN CONSENT OF GRAPHIC HOUSE, INC. A DESIGN FEE OF NOT LESS THAN \$5000 WILL BE INVOICED IF THIS DRAWING IS SHARED OR COPIED BY ANYONE WHILE IN YOUR POSSESSION. THIS DOES NOT EXCLUDE ADDITIONAL COMPENSATION THAT MAY BE AWARDED DUE TO COPYRIGHT INFRINGEMENT.

RELEASE AUTH:

DISCLAIMER: THE INK COLORS SHOWN IN THIS RENDERING PROVIDE CONCEPTUAL COLORS & GRAPHICS LOCATIONS ONLY. THE COLORS MAY NOT MATCH THE ACTUAL AUTOMOTIVE PRINTS OR THE VINYL COLORS THAT WILL BE USED ON OR IN THE SIGN(S) SHOWN. ALL SIZES, SHAPES, COLORS, ETC. ARE CONCEPTUAL & MAY VARY FROM ACTUAL PRODUCT

- (1) S/F INTERN. ILLUM. INTERIOR HANGING SIGN
- * SIGN CABINET IS TO BE FORMED OF ALUM. PAINTED BLACK.
- * FACE IS TO BE WHITE POLYCARBONATE. ALL COPY IS TO BE WHITE w/ #3630-22 BLACK VINYL SHADOW & OPAQUE #8500-031 RED VINYL BACKGROUND.
- * PERFORATED METAL (.063" ALUM.) IS TO BE PAINTED BLACK & MOUNTED 1" OFF FACE OF SIGN.
- * SIGN IS TO BE HUNG FROM INTERIOR CEILING w/ SQUARE TUBE FRAME PAINTED BLACK.

(1) INTERN. ILLUM. INTERIOR
HANGING SIGN REQ'd



APPROX. NIGHT VIEW

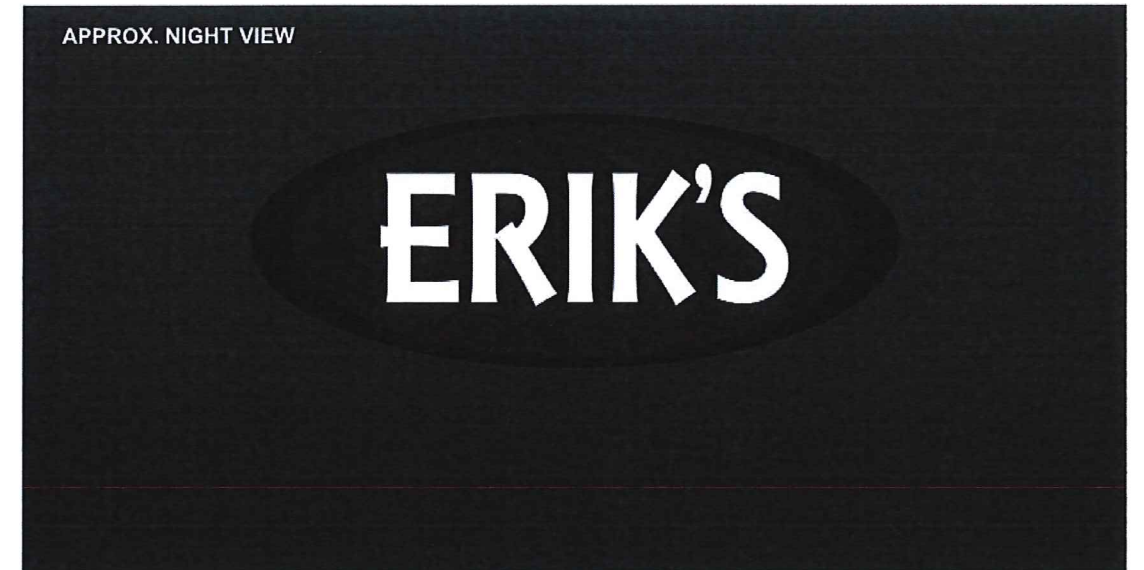

CLIENT HAS IDENTIFIED THE LOCATION IN WHICH THE SIGNAGE IS TO BE INSTALLED. THE CLIENT HAS THE SOLE RESPONSIBILITY FOR THE STRUCTURAL INTEGRITY OF ALL EXISTING STRUCTURES TO SUPPORT THE SIGNAGE.

ISSUE DATES:

RF/ISI DATE:

This document contains confidential or proprietary information of Iconica. Neither the document nor the information herein is to be reproduced, distributed, used or disclosed, either in whole or in part, except as specifically authorized by Iconica.

PROJECT #: 20140810

SHEET NUMBER

E100

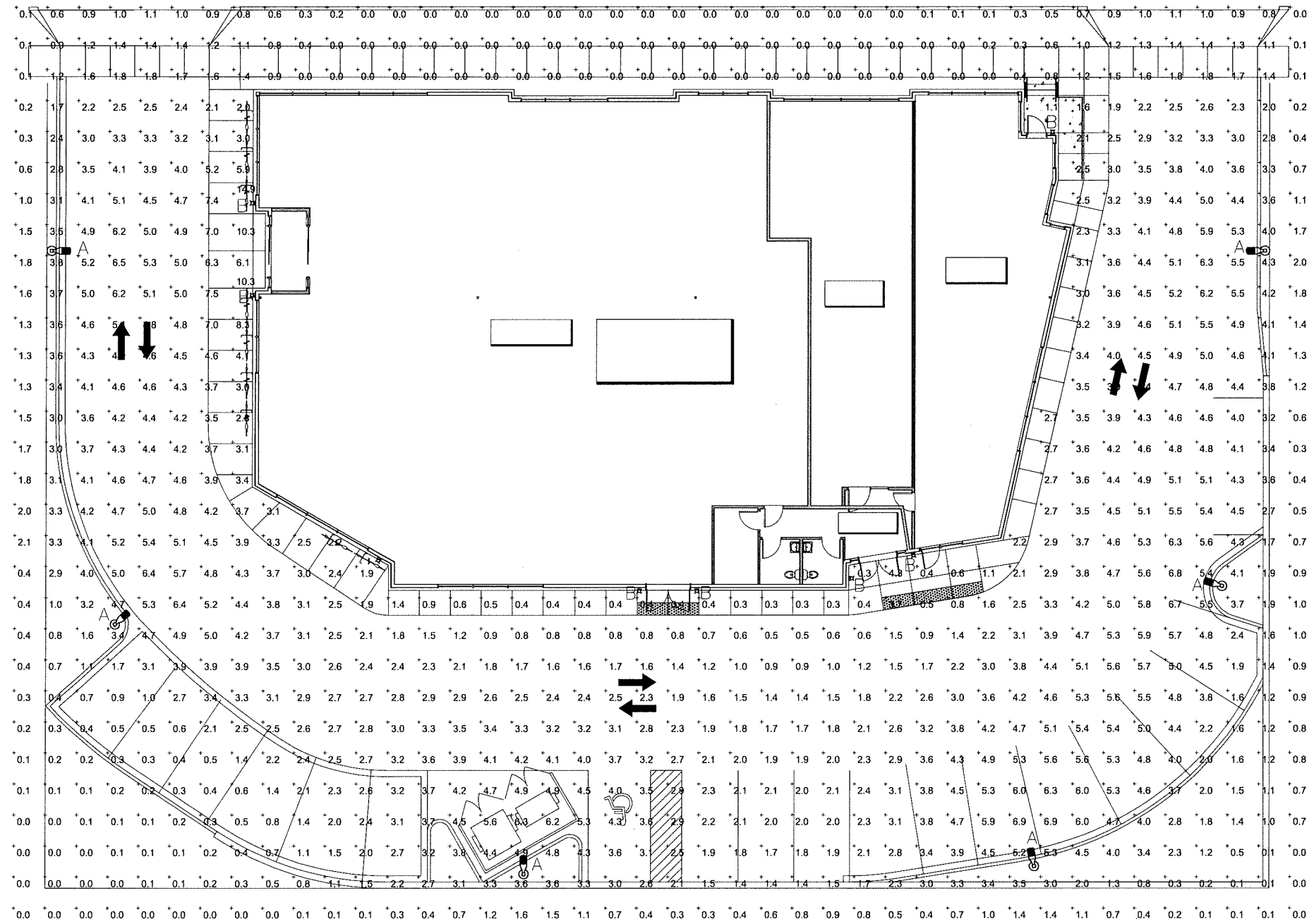

1 SITE PLAN - LIGHTING PHOTOMETRICS
SCALE: 1" = 10'

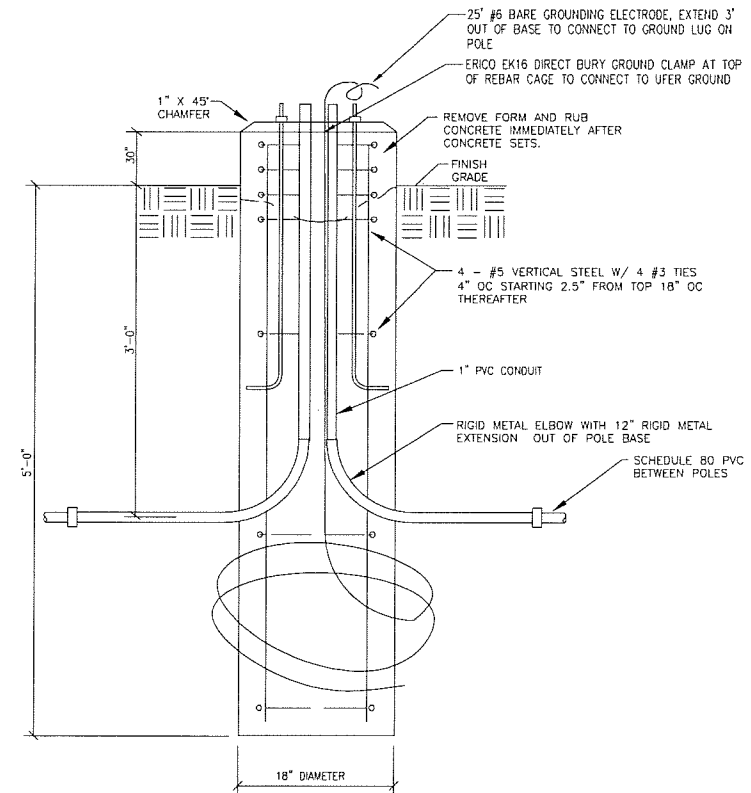

2 POLE BASE DETAIL
SCALE: NOT TO SCALE

LIGHT FIXTURE SCHEDULE								
ID	Description	Size	Manufacturer	Model #	Voltage	Lamps	Mounting	Remarks
A	LED POST MOUNTED AREA LIGHT, TYPE 4 DISTRIBUTION	33"x13"	LITHONIA	DSX1 LED 50C 700 40K T4M MVOLF HS	120	LED, 4000K, 131W, 80+CRI	1' SQUARE ALUMINUM POLE	
B	WALL MOUNTED ENTRY LIGHT, FULL CUTOFF		RAB	SUM12N	120	LED, 4000K, 14W, 80+CRI, 1370L	WALL 5'AFF	

EXTERIOR LIGHTING POWER CALCULATION							
BUILDING TYPE: RETAIL				ZONE: 2			
Description	Code	Area (SF) Length (LF)	Allowable (W)	Light Fixtures			Total Watts
				ID	# Fixtures	Watts /Fixture	
BASE SITE ALLOWANCE	600	w	600	A	6	131	786
PARKING LOT & DRIVES	0.06	W/SF	12,071	B	7	14	98
MAIN ENTRY	20	W/LF	12				
OTHER DOORS	20	W/LF	12				
WALKWAYS < 10' WIDE	0.7	W/LF	250				
TOTALS			LIGHTING ALLOWANCE			DESIGN TOTAL	884
	1986	>	884	EXTERIOR COMPLIES WITH THE ENERGY CODE			

©2014 Iconica, Inc.



D-Series Size 1 LED Area Luminaire



Catalog Number
Notes
Type

Hit the Tab key or mouse over the page to see all interactive elements.

d"series

TYPE - A&B

Specifications

EPA:	1.2 ft ² (0.11 m ²)
Length:	33" (83.8 cm)
Width:	13" (33.0 cm)
Height:	7-1/2" (19.0 cm)
Weight (max):	27 lbs (12.2 kg)

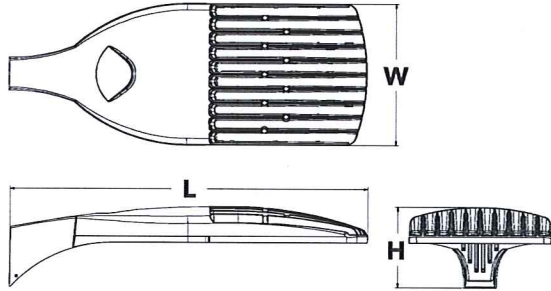

Introduction

The modern styling of the D-Series is striking yet unobtrusive - making a bold, progressive statement even as it blends seamlessly with its environment.

The D-Series distills the benefits of the latest in LED technology into a high performance, high efficacy, long-life luminaire. The outstanding photometric performance results in sites with excellent uniformity, greater pole spacing and lower power density. It is ideal for replacing 100 - 400W metal halide in pedestrian and area lighting applications with typical energy savings of 65% and expected service life of over 100,000 hours.

Ordering Information

EXAMPLE: DSX1 LED 60C 1000 40K T3M MVOLT SPA DDBXD

DSX1 LED

Series	LEDs	Drive current	Color temperature	Distribution	Voltage	Mounting	Control options	Other options	Finish (required)
DSX1 LED	Forward optics	530 530 mA	30K 3000 K (80 CRI min.)	T1S Type I short	MVOLT ³	Shipped included SPA Square pole mounting RPA Round pole mounting WBA Wall bracket SPUMBA Square pole universal mounting adaptor ⁵ RPUMBA Round pole universal mounting adaptor ⁵ Shipped separately⁶ KMA8 Mast arm mounting bracket adaptor (specify finish) DDBXD U	Shipped installed PER NEMA twist-lock receptacle only (no controls) ⁷ DMG 0-10V dimming driver (no controls) ⁸ DCR Dimmable and controllable via ROAM [®] (no controls) ⁹ DS Dual switching ^{10,11} PIR Motion sensor, 8-15' mounting height ¹² PIRH Motion sensor, 15-30' mounting height ¹² BL30 Bi-level switched dimming, 30% ^{11,13} BL50 Bi-level switched dimming, 50% ^{11,13}	Shipped installed HS House-side shield ¹⁴ WTB Utility terminal block ¹⁵ SF Single fuse (120, 277, 347V) ¹⁶ DF Double fuse (208, 240, 480V) ¹⁶ L90 Left rotated optics ¹⁷ R90 Right rotated optics ¹⁷	DDBXD Dark bronze DBLXD Black DNAXD Natural aluminum DWHXD White DDBTXD Textured dark bronze DBLBXD Textured black DNATXD Textured natural aluminum DWHGXD Textured white
	30C 30 LEDs (one engine)	700 700 mA	40K 4000 K (70 CRI min.)	T2S Type II short	120 ³				
	40C 40 LEDs (two engines)	1000 1000 mA (1 A)	50K 5000 K (70 CRI)	T2M Type II medium	208 ³				
	60C 60 LEDs (two engines)		AMBPC Amber phosphor converted ²	T3S Type III short	240 ³				
	Rotated optics ¹			T3M Type III medium	277 ³				
	60C 60 LEDs (two engines)			T4M Type IV medium	347 ⁴				
				TFTM Forward throw medium	480 ⁴				
				T5VS Type V very short					
				T5S Type V short					
				T5M Type V medium					

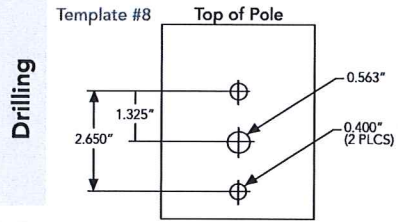

DSX1 shares a unique drilling pattern with the AERIS™ family. Specify this drilling pattern when specifying poles, per the table below.

DM19AS	Single unit	DM29AS	2 at 90°*
DM28AS	2 at 180°	DM39AS	3 at 90°*
DM49AS	4 at 90°*	DM32AS	3 at 120°**

Example: SSA 20 4C DM19AS DDBXD

Visit Lithonia Lighting's **POLES CENTRAL** to see our wide selection of poles, accessories and educational tools.

*Round pole top must be 3.25" O.D. minimum.
**For round pole mounting (RPA) only.

Tenon Mounting Slipfitter**

Tenon O.D.	Single Unit	2 at 180°	2 at 90°	3 at 120°	3 at 90°	4 at 90°
2-3/8"	AST20-190	AST20-280	AST20-290	AST20-320	AST20-390	AST20-490
2-7/8"	AST25-190	AST25-280	AST25-290	AST25-320	AST25-390	AST25-490
4"	AST35-190	AST35-280	AST35-290	AST35-320	AST35-390	AST35-490

NOTES

- Rotated optics only available with 60C.
- AMBPC only available with 530mA or 700mA.
- MVOLT driver operates on any line voltage from 120-277V (50/60 Hz). Specify 120, 208, 240 or 277 options only when ordering with fusing (SF, DF options).
- Not available with single board, 530mA product (30C 530, or 60C 530 DS). Not available with DCR, BL30 or BL50.
- Available as a separate combination accessory: PUMBA (finish) U.
- Must be ordered as a separate accessory; see Accessories information. For use with 2-3/8" mast arm (not included).
- Photocell ordered and shipped as a separate line item from Acuity Brands Controls. See accessories. Not available with DS or DCR.
- DMG option for 347v or 480v requires 1000mA
- Specifies a ROAM[®] enabled luminaire with 0-10V dimming capability; PER option required. Not available with 347 or 480V. Additional hardware and services required for ROAM[®] deployment; must be purchased separately. Call 1-800-442-6745 or email: sales@roomservices.net. N/A with BL30, BL50, DS, PIR or PIRH.
- Requires 40C or 60C. Provides 50/50 luminaire operation via two independent drivers on two separate circuits. N/A with PER, DCR, WTB, PIR, or PIRH.
- Requires an additional switched circuit.
- PIR specifies the SensorSwitch SBGR-10-ODP control; PIRH specifies the SensorSwitch SBGR-6-ODP control; see Motion Sensor Guide for details. Dimming driver standard. Not available with DS or DCR.
- Dimming driver standard. MVOLT only. Not available with DCR.
- Also available as a separate accessory; see Accessories information.
- WTB not available with DS.
- Single fuse (SF) requires 120, 277 or 347 voltage option. Double fuse (DF) requires 208, 240 or 480 voltage option.
- Available with 60 LEDs (60C option) only.
- Requires luminaire to be specified with PER option. Ordered and shipped as a separate line item from Acuity Brands Control.

Accessories

DLL127F 1.5 JU	Photocell - SSL twist-lock (120-277V) ¹¹
DLL347F 1.5 CUL JU	Photocell - SSL twist-lock (347V) ¹¹
DLL480F 1.5 CUL JU	Photocell - SSL twist-lock (480V) ¹¹
SCU	Shorting cap ¹¹
DSX1HS 30C U	House-side shield for 30 LED unit
DSX1HS 40C U	House-side shield for 40 LED unit
DSX1HS 60C U	House-side shield for 60 LED unit
PUMBA DDBXD U*	Square and round pole universal mounting bracket adaptor (specify finish)
KMA8 DDBXD U	Mast arm mounting bracket adaptor (specify finish) ¹⁴

For more control options, visit [DII](#) and [ROAM](#) online.



Lumen Output

Lumen values are from photometric tests performed in accordance with IESNA LM-79-08. Data is considered to be representative of the configurations shown, within the tolerances allowed by Lighting Facts. Actual performance may differ as a result of end-user environment and application. Actual wattage may differ by +/- 8% when operating between 120-480V +/-10%. Contact factory for performance data on any configurations not shown here.

LEDs	Drive Current (mA)	System Watts	Dist. Type	30K (3000 K, 80 minimum CRI)					40K (4000 K, 70 minimum CRI)					50K (5000 K, 70 CRI)					
				Lumens	B	U	G	LPW	Lumens	B	U	G	LPW	Lumens	B	U	G	LPW	
				30C (30 LEDs)	700 mA	68 W	T1S	5,290	1	0	1	78	6,524	2	0	2	96	7,053	2
T2S	5,540	1	0				1	81	6,833	2	0	2	100	7,387	2	0	2	109	
T2M	5,360	1	0				2	79	6,611	2	0	2	97	7,147	2	0	2	105	
T3S	5,479	1	0				1	81	6,757	1	0	2	99	7,305	2	0	2	107	
T3M	5,452	1	0				2	80	6,724	2	0	2	99	7,269	2	0	2	107	
T4M	5,461	1	0				2	80	6,736	2	0	2	99	7,282	2	0	2	107	
TFTM	5,378	1	0				2	79	6,633	1	0	2	98	7,171	1	0	2	105	
TSVS	5,708	2	0				0	84	7,040	3	0	0	104	7,611	3	0	1	112	
T5S	5,639	2	0				0	83	6,955	2	0	0	102	7,519	3	0	0	111	
T5M	5,710	3	0				1	84	7,042	3	0	1	104	7,613	3	0	2	112	
T5W	5,551	3	0				1	82	6,847	3	0	2	101	7,401	3	0	2	109	
T1S	7,229	2	0				2	69	9,168	2	0	2	87	9,874	2	0	2	94	
T2S	7,572	2	0				2	72	9,603	2	0	2	91	10,342	2	0	2	98	
T2M	7,325	2	0				2	70	9,291	2	0	2	88	10,005	2	0	3	95	
T3S	7,488	2	0				2	71	9,496	2	0	2	90	10,227	2	0	2	97	
T3M	7,451	2	0		2	71	9,450	2	0	2	90	10,177	2	0	2	97			
T4M	7,464	2	0		2	71	9,467	2	0	2	90	10,195	2	0	2	97			
TFTM	7,351	1	0		2	70	9,323	2	0	2	89	10,040	2	0	3	96			
TSVS	7,801	3	0		1	74	9,894	3	0	1	94	10,655	3	0	1	101			
T5S	7,803	3	0		2	74	9,774	3	0	1	93	10,526	3	0	1	100			
T5M	7,707	3	0		0	73	9,897	3	0	2	94	10,658	4	0	2	102			
T5W	7,586	3	0		2	72	9,621	4	0	2	92	10,363	4	0	2	99			
40C (40 LEDs)	700 mA	89 W	T1S		6,876	2	0	2	77	8,639	2	0	2	97	9,345	2	0	2	105
			T2S		7,202	2	0	2	81	9,049	2	0	2	102	9,788	2	0	2	110
			T2M		6,968	2	0	2	78	8,755	2	0	2	98	9,469	2	0	3	106
			T3S		7,122	2	0	2	80	8,948	2	0	2	101	9,679	2	0	2	109
			T3M		7,088	2	0	2	80	8,905	2	0	2	100	9,632	2	0	2	108
			T4M		7,100	2	0	2	80	8,920	2	0	2	100	9,649	2	0	2	108
			TFTM		6,992	1	0	2	79	8,785	2	0	2	99	9,502	2	0	2	107
			TSVS		7,421	3	0	0	83	9,323	3	0	1	105	10,085	3	0	1	113
			T5S	7,331	2	0	0	82	9,210	3	0	1	103	9,962	3	0	1	112	
			T5M	7,423	3	0	2	83	9,326	3	0	2	105	10,087	4	0	2	113	
			T5W	7,216	3	0	2	81	9,066	4	0	2	102	9,807	4	0	2	110	
			T1S	9,521	2	0	2	69	11,970	2	0	2	87	12,871	3	3	0	93	
			T2S	9,972	2	0	2	72	12,558	3	0	3	91	13,481	3	0	3	98	
			T2M	9,648	2	0	3	70	12,149	3	0	3	88	13,043	3	0	3	95	
			T3S	9,862	2	0	2	71	12,418	2	0	2	90	13,331	2	0	2	97	
	T3M	9,814	2	0	2	71	12,358	3	0	3	90	13,267	3	0	3	96			
	T4M	9,831	2	0	2	71	12,379	2	0	3	90	13,290	2	0	3	96			
	TFTM	9,681	2	0	2	70	12,191	2	0	3	88	13,087	2	0	3	95			
	TSVS	10,275	3	0	1	74	12,937	3	0	1	94	13,890	4	0	1	101			
	T5S	10,150	3	0	1	74	12,782	3	0	1	93	13,721	3	0	1	99			
	T5M	10,278	4	0	2	74	12,942	4	0	2	94	13,894	4	0	2	101			
	T5W	9,991	4	0	2	72	12,582	4	0	2	91	13,507	4	0	2	98			
	60C (60 LEDs)	700 mA	131 W	T1S	10,226	2	0	2	78	12,871	3	0	3	98	13,929	3	0	3	106
				T2S	10,711	2	0	2	82	13,481	3	0	3	103	14,589	3	0	3	111
				T2M	10,363	2	0	3	79	13,043	3	0	3	100	14,115	3	0	3	108
				T3S	10,592	2	0	2	81	13,331	2	0	2	102	14,427	3	0	3	110
				T3M	10,541	2	0	2	80	13,267	3	0	3	101	14,357	3	0	3	110
				T4M	10,559	2	0	2	81	13,290	2	0	3	101	14,382	3	0	3	110
				TFTM	10,398	2	0	3	79	13,087	2	0	3	100	14,163	2	0	3	108
				TSVS	11,036	3	0	1	84	13,890	4	0	4	106	15,032	4	0	1	115
T5S				10,902	3	0	1	83	13,721	3	0	1	105	14,849	4	0	1	113	
T5M				11,039	4	0	2	84	13,894	4	0	2	106	15,036	4	0	2	115	
T5W				10,732	4	0	2	82	13,507	4	0	2	103	14,617	4	0	2	112	
T1S				14,017	3	0	3	67	17,632	3	0	3	84	19,007	3	0	3	91	
T2S				14,681	3	0	3	70	18,467	3	0	3	88	19,908	3	0	3	95	
T2M				14,204	3	0	3	68	17,867	3	0	3	85	19,260	3	0	3	92	
T3S				14,518	3	0	3	69	18,262	3	0	3	87	19,687	3	0	3	94	
T3M		14,448	3	0	3	69	18,173	3	0	4	87	19,591	3	0	4	94			
T4M		14,473	3	0	3	69	18,205	3	0	3	87	19,625	3	0	4	94			
TFTM		14,253	2	0	3	68	17,928	3	0	4	86	19,326	3	0	4	92			
TSVS		15,127	4	0	1	72	19,028	4	0	1	91	20,512	4	0	1	98			
T5S		14,943	4	0	1	71	18,797	4	0	1	90	20,263	4	0	1	97			
T5M		15,131	4	0	2	72	19,033	4	0	2	91	20,517	5	0	3	98			
T5W		14,710	4	0	2	70	18,503	5	0	3	89	19,946	5	0	3	95			

Note: Available with phosphor-converted amber LED's (nomenclature AMBPC). These LED's produce light with 97+% >530 nm. Output can be calculated by applying a 0.7 factor to 4000 K lumen values and photometric files.



Performance Data

Lumen Ambient Temperature (LAT) Multipliers

Use these factors to determine relative lumen output for average ambient temperatures from 0-40°C (32-104°F).

Ambient		Lumen Multiplier
0°C	32°F	1.02
10°C	50°F	1.01
20°C	68°F	1.00
25°C	77°F	1.00
30°C	86°F	1.00
40°C	104°F	0.99

Projected LED Lumen Maintenance

Data references the extrapolated performance projections for the platforms noted in a 25°C ambient, based on 10,000 hours of LED testing (tested per IESNA LM-80-08 and projected per IESNA TM-21-11).

To calculate LLF, use the lumen maintenance factor that corresponds to the desired number of operating hours below. For other lumen maintenance values, contact factory.

Operating Hours	0	25,000	50,000	100,000
Lumen Maintenance Factor	DSX1 LED 60C 1000			
	1.0	0.95	0.93	0.88
	DSX1 LED 60C 700			
	1.0	0.99	0.98	0.96

Electrical Load

Number of LEDs	Drive Current (mA)	System Watts	Current (A)					
			120	208	240	277	347	480
30	530	52	0.52	0.30	0.26	0.23	--	--
	700	68	0.68	0.39	0.34	0.30	0.24	0.17
	1000	105	1.03	0.59	0.51	0.45	0.36	0.26
40	530	68	0.67	0.39	0.34	0.29	0.23	0.17
	700	89	0.89	0.51	0.44	0.38	0.31	0.22
	1000	138	1.35	0.78	0.67	0.58	0.47	0.34
60	530	99	0.97	0.56	0.48	0.42	0.34	0.24
	700	131	1.29	0.74	0.65	0.56	0.45	0.32
	1000	209	1.98	1.14	0.99	0.86	0.69	0.50

Photometric Diagrams

To see complete photometric reports or download .ies files for this product, visit Lithonia Lighting's [D-Series Area Size 1 homepage](#).

Isofootcandle plots for the DSX1 LED 60C 1000 40K. Distances are in units of mounting height (20').

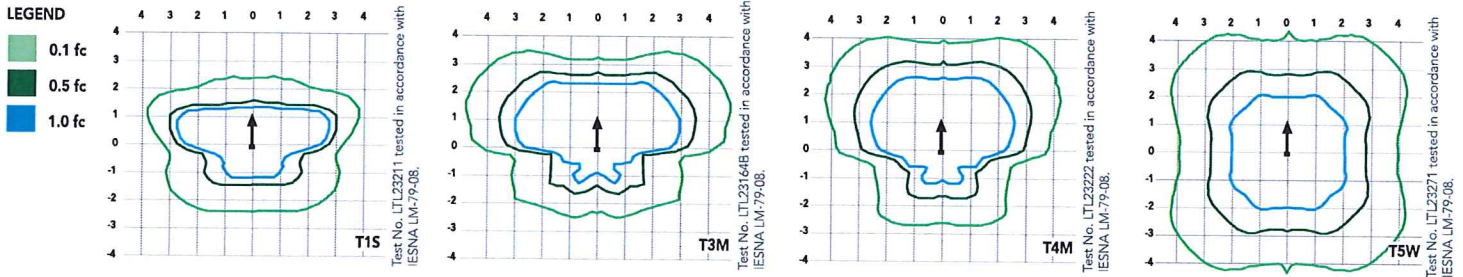

FEATURES & SPECIFICATIONS

INTENDED USE

The sleek design of the D-Series Size 1 reflects the embedded high performance LED technology. It is ideal for many commercial and municipal applications, such as parking lots, plazas, campuses, and streetscapes.

CONSTRUCTION

Single-piece die-cast aluminum housing has integral heat sink fins to optimize thermal management through conductive and convective cooling. Modular design allows for ease of maintenance and future light engine upgrades. The LED driver is mounted in direct contact with the casting to promote low operating temperature and long life. Housing is completely sealed against moisture and environmental contaminants (IP65). Low EPA (1.2 ft²) for optimized pole wind loading.

FINISH

Exterior parts are protected by a zinc-infused Super Durable TGIC thermoset powder coat finish that provides superior resistance to corrosion and weathering. A tightly controlled multi-stage process ensures a minimum 3 mils thickness for a finish that can withstand extreme climate changes without cracking or peeling. Available in both textured and non-textured finishes.

OPTICS

Precision-molded proprietary acrylic lenses are engineered for superior area lighting distribution, uniformity, and pole spacing. Light engines are available in standard 4000 K (70 minimum CRI) or optional 3000 K (80 minimum CRI) or 5000 K (70 CRI) configurations. The D-Series Size 1 has zero uplight and qualifies as a Nighttime Friendly™ product, meaning it is consistent with the LEED® and Green Globes™ criteria for eliminating wasteful uplight.

ELECTRICAL

Light engine configurations consist of 30, 40 or 60 high-efficacy LEDs mounted to metal-core circuit boards to maximize heat dissipation and promote long life (up to L96/100,000 hours at 25°C). Class 1 electronic drivers are designed to have a power factor >90%, THD <20%, and an

expected life of 100,000 hours with <1% failure rate. Easily serviceable 10kV or 6kV surge protection device meets a minimum Category C Low operation (per ANSI/IEEE C62.41.2).

INSTALLATION

Included mounting block and integral arm facilitate quick and easy installation. Stainless steel bolts fasten the mounting block securely to poles and walls, enabling the D-Series Size 1 to withstand up to a 3.0 G vibration loading rating per ANSI C136.31. The D-Series Size 1 utilizes the AERIS™ series pole drilling pattern. Optional terminal block, tool-less entry, and NEMA photocontrol receptacle are also available.

LISTINGS

UL Listed for wet locations. Light engines are IP66 rated; luminaire is IP65 rated. Rated for -40°C minimum ambient. U.S. Patent No. D672,492 S. International patent pending.

DesignLights Consortium® (DLC) qualified product. Not all versions of this product may be DLC qualified. Please check the DLC Qualified Products List at www.designlights.org to confirm which versions are qualified.

WARRANTY

Five-year limited warranty. Full warranty terms located at: www.acuitybrands.com/CustomerResources/Terms_and_conditions.aspx

Note: Specifications subject to change without notice.



SLIM12N

TYPE - C

12, 18 and 26 Watt SLIM wallpacks are ultra efficient and deliver impressive light distribution with a compact low-profile design that's super easy to install as a downlight or uplight.

Color: Bronze

Weight: 4.5 lbs

LED Info

Watts: 12W
Color Temp: 4000K (Neutral)
Color Accuracy: 82
L70 Lifespan: 100000
LM79 Lumens: 1372
Efficacy: 99 LPW

Driver Info

Type: Constant Current
120V: 0.12A
208V: 0.08A
240V: 0.07A
277V: 0.06A
Input Watts: 14W
Efficiency: 86%

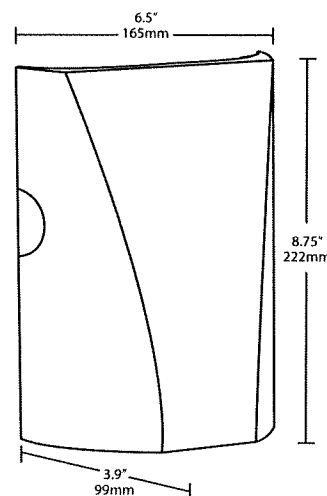

Technical Specifications

UL Listing:

Suitable for wet locations. Suitable for mounting within 1.2m (4ft) of the ground.

IP Rating:

Ingress Protection rating of IP66 for dust and water.

LED:

Multi-chip, long-life LED.

Lifespan:

100,000-hour LED lifespan based on IES LM-80 results and TM-21 calculations.

Driver:

Constant Current, Class 2, 100-277V, 50/60 Hz., 4KV surge protection, 350mA, 100-240VAC 0.3-0.15 Amps, 277VAC 0.15Amps, Power Factor 99%.

THD:

10.1% at 120V

Cold Weather Starting:

The minimum starting temperature is -40°F/-40°C.

Ambient Temperature:

Suitable for use in 40°C (104°F) ambient temperatures.

Thermal Management:

Superior heat sinking with internal Air-Flow fins.

Housing:

Precision die-cast aluminum housing.

Mounting:

Heavy-duty mounting bracket with hinged housing for easy installation.

Recommended Mounting Height:

Up to 8 ft.

HID Replacement Range:

The SLIM12 can be used to replace 70W MH based on delivered lumens.

Lens:

Tempered glass lens.

Reflector:

Specular thermoplastic.

Gaskets:

High-temperature silicone.

Finish:

Our environmentally friendly polyester powder coatings are formulated for high-durability and long-lasting color, and contains no VOC or toxic heavy metals.

ADA Compliant:

SLIM™ is ADA Compliant.

DLC Listed:

This product is on the Design Lights Consortium (DLC) Qualified Products List and is eligible for rebates from DLC Member Utilities.

Dark Sky Approved:

The International Dark Sky Association has approved this product as a full cutoff, fully shielded luminaire.

Color Consistency:

3-step MacAdam Ellipse binning to achieve consistent fixture-to-fixture color.

Color Stability:

LED color temperature is warranted to shift no more than 200K in CCT over a 5 year period.

RAB
LIGHTING

Tech Help Line: 888 RAB-1000

Email: sales@rabweb.com

On the web at: www.rabweb.com

Color Uniformity:

RAB's range of CCT (Correlated Color Temperature) follows the guidelines for the American National Standard for Specifications for the Chromaticity of Solid State Lighting (SSL) Products, ANSI C78.377-2011.

Green Technology:

Mercury and UV free, and RoHS compliant.

California Title 24:

SLIM12 complies with 2013 California Title 24 building and electrical codes as a residential outdoor fixture. See SLIM12/PC for a model that complies as a commercial outdoor non-pole-mounted fixture ≤ 30 Watts.

IESNA LM-79 & LM-80 Testing:

RAB LED luminaires have been tested by an independent laboratory in accordance with IESNA LM-79 and LM-80, and have received the Department of Energy "Lighting Facts" label.

Patents:

The design of the SLIM™ is protected by patents in U.S. Pat D681,864, and pending patents in Canada, China, Taiwan and Mexico.

Country of Origin:

Designed by RAB in New Jersey and assembled in the USA by RAB's IBEW Local 3 workers.

Buy American Act Compliant:

This product is a COTS item manufactured in the United States, and is compliant with the Buy American Act.

Recovery Act (ARRA) Compliant:

This product complies with the 52.225-21 "Required Use of American Iron, Steel, and Manufactured Goods-- Buy American Act-- Construction Materials (October 2010).

Trade Agreements Act Compliant:

This product is a COTS item manufactured in the United States, and is compliant with the Trade Agreements Act.

GSA Schedule:

Suitable in accordance with FAR Subpart 25.4.