

# Plat of Survey

Legal Description of Record: Document Number 5743136

THE SOUTHEAST 39 FEET IN WIDTH OF LOT THREE (3), BLOCK 114, ORIGINAL PLAT OF MADISON, IN THE CITY OF MADISON, DANE COUNTY, WISCONSIN MORE PARTICULARLY DESCRIBED AS FOLLOWS:

BEGINNING AT THE EAST CORNER OF LOT 3, BLOCK 114; THENCE SOUTHWESTERLY ON THE LINE BETWEEN LOTS 3 AND 4, 132 FEET; THENCE NORTHWESTERLY ON THE LINE BETWEEN LOTS 3 AND 16, 39 FEET; THENCE NORTHEAST 132 FEET TO HANCOCK STREET; THENCE SOUTHEASTERLY ON HANCOCK STREET 39 FEET TO THE POINT OF BEGINNING.

Notes:

1. Building dimensions and associated offset distances were measured along the outside of the siding.
2. This parcel may be subject to, or benefit from, Easements or agreements, written or otherwise, not shown hereon.

LEGEND

- ▲ FOUND PK OR MAG NAIL
- SOLID IRON ROD FOUND (0.75" Dia. unless noted)
- ⊙ IRON PIPE FOUND (1" Outside Diam. unless Noted)
- 3/4"x18" SOLID IRON ROD SET 1.50Lbs./LINEAL FOOT.
- ( ) INDICATES RECORDED AS DISTANCES ARE MEASURED TO THE NEAREST HUNDREDTH OF A FOOT.

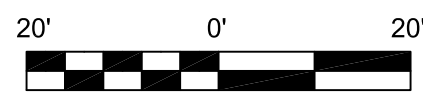
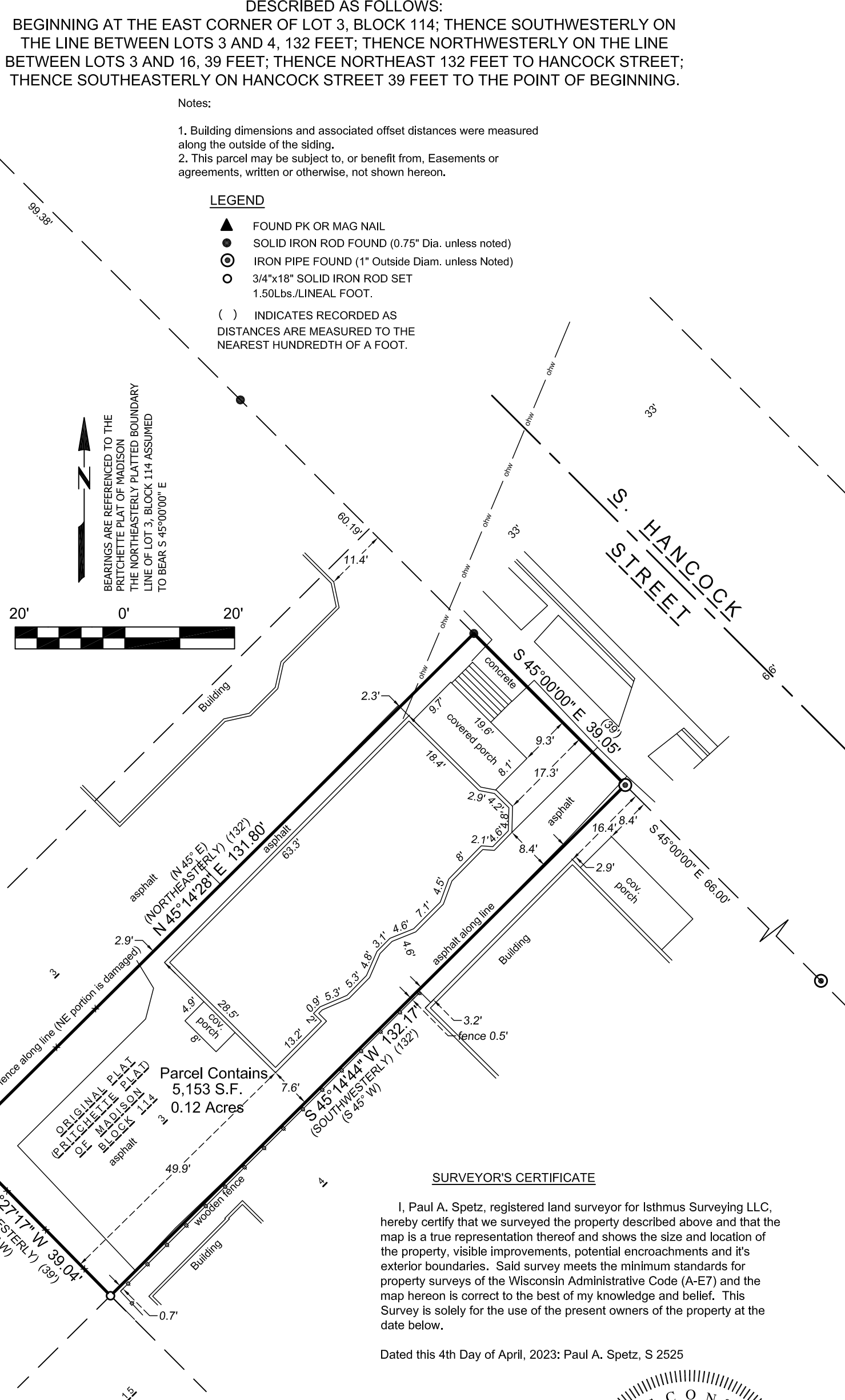

BEARINGS ARE REFERENCED TO THE PRITCHETTE PLAT OF MADISON THE NORTHEASTERLY PLATTED BOUNDARY LINE OF LOT 3, BLOCK 114 ASSUMED TO BEAR S 45°00'00\"/>

Parcel Contains  
5,153 S.F.  
0.12 Acres

SURVEYOR'S CERTIFICATE

I, Paul A. Spetz, registered land surveyor for Isthmus Surveying LLC, hereby certify that we surveyed the property described above and that the map is a true representation thereof and shows the size and location of the property, visible improvements, potential encroachments and it's exterior boundaries. Said survey meets the minimum standards for property surveys of the Wisconsin Administrative Code (A-E7) and the map hereon is correct to the best of my knowledge and belief. This Survey is solely for the use of the present owners of the property at the date below.

Dated this 4th Day of April, 2023: Paul A. Spetz, S 2525

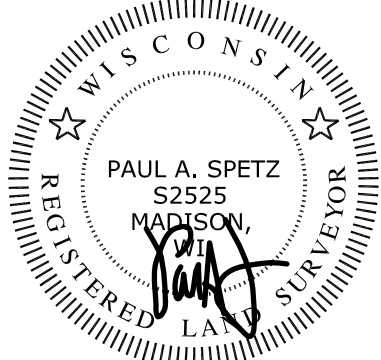

PREPARED FOR:  
ARP EBERLE ARCHITECTS  
433 W WASHINGTON AVENUE, SUITE 400  
MADISON, WI 53703

PREPARED BY:  
ISTHMUS SURVEYING, LLC  
450 NORTH BALDWIN STREET  
MADISON, WI 53703  
(608) 244.1090  
www.isthmussurveying.com



**HATCH SYMBOLS**

	EARTHWORK		PLYWOOD
	GRAVEL		FINISH LUMBER
	PLASTER, SAND, GROUT		WOOD STUDS, BLOCKING
	CONCRETE		STEEL STUDS
	CONCRETE MASONRY		GYPSUM WALLBOARD
	CLAY MASONRY		ACOUSTICAL TILE
	PRECAST CONCRETE		BATT INSULATION
	METAL		RIGID INSULATION

**ABBREVIATIONS:**

ADA - AMERICAN WITH DISABILITIES ACT  
AFF - ABOVE FINISHED FLOOR  
CFI - CONTRACTOR FURNISHED CONTRACTOR INSTALLED  
CFM - CUBIC FOOT PER MINUTE  
CL - CENTERLINE  
CLNG - CEILING  
CLR - CLEAR  
DIM - DIMENSION  
DN - DOWN  
EA - EACH  
EQ - EQUAL  
FD - FLOOR DRAIN  
FEC - FIRE EXTINGUISHER CABINET  
GC - GENERAL CONTRACTOR  
GWB - GYPSUM WALL BOARD  
MAX - MAXIMUM  
MIN - MINIMUM  
MISC - MISCELLANEOUS  
MTD - MOUNTED  
NTS - NOT TO SCALE  
OFCI - OWNER FURNISHED CONTRACTOR INSTALLED  
OFOI - OWNER FURNISHED OWNER INSTALLED  
OPP - OPPOSITE  
SIM - SIMILAR  
SS - STAINLESS STEEL  
STD - STANDARD  
THK - THICK  
TYP - TYPICAL  
UNO - UNLESS OTHERWISE NOTED  
W/ - WITH

**MEP/FP DESIGN-BUILD SCOPE OF WORK**

**MECHANICAL SCOPE OF WORK**

**GENERAL**

- MECHANICAL CONTRACTOR TO PROVIDE DEMOLITION OF ALL EXISTING MECHANICAL SYSTEMS WITHIN THE BUILDING (COORDINATE WITH G.C.).
- MECHANICAL CONTRACTOR TO PROVIDE DESIGN OF SYSTEMS FOR FIVE INDIVIDUAL TENANT SPACES WITH INDIVIDUAL PROGRAMMABLE CONTROLS / THERMOSTATS, AS WELL AS BATHROOM EXHAUST FANS AND ELECTRIC WALL HEATERS IN COMMON AREAS SUCH AS STAIRWELLS.
- MECHANICAL BASIS OF DESIGN: HEAT PUMP SYSTEM.
- EQUIPMENT TO BE INSTALLED WITHIN EACH TENANT SPACE AND ON THE SITE. SEE THE SITE PLAN ON A010 & A011 FOR EQUIPMENT LOCATIONS.
- SUBMITTAL REQUIREMENTS:** MECHANICAL CONTRACTOR TO PROVIDE EQUIPMENT CUT SHEETS AND DUCTWORK LAYOUT PLANS FOR THE ARCHITECT TO APPROVE.
- FOLLOW ALL APPLICABLE CODES.
- OBTAIN ALL NECESSARY PERMITS AND INSPECTIONS APPLICABLE TO ELECTRICAL WORK.

**FIRE PROTECTION SCOPE OF WORK:**

**SPRINKLER SYSTEM:**

- PROVIDE NEW NFPA 13R SPRINKLER SYSTEMS THROUGHOUT ALL APPLICABLE SPACES OF BUILDING.
- PROVIDE DRY-PIPE SYSTEM IN ATTIC SPACE IF REQUIRED.
- PROVIDE CONCEALED HEADS IN GWB CEILINGS.

**SMOKE ALARM SYSTEM:**

- DESIGN AND INSTALL A SMOKE ALARM SYSTEM IN ACCORDANCE WITH IBC 907.2.11.2 AND ANY OTHER APPLICABLE CODES

**PLUMBING SCOPE OF WORK**

**GENERAL**

- DEMOLITION OF ALL EXISTING PLUMBING WITHIN THE BUILDING (COORDINATE WITH G.C.).
- COORDINATE WITH FIRE PROTECTION CONTRACTOR.
- PROVIDE SINGLE BUILDING-WIDE WATER SOFTENER.
- PROVIDE CENTRALIZED WATER HEATING SYSTEM TO SERVE EACH TENANT SPACE.
- PROVIDE PLUMBING TO ALL RESTROOMS AND PLUMBING FIXTURES AS SHOWN ON THE PLANS.
- WATER SUPPLY PIPING TO BE PEX OR CPVC.
- FOLLOW ALL APPLICABLE CODES.
- OBTAIN ALL NECESSARY PERMITS AND INSPECTIONS APPLICABLE TO ELECTRICAL WORK.
- SUBMITTAL REQUIREMENTS:** PLUMBING CONTRACTOR TO PROVIDE FIXTURE CUT SHEETS, AND EQUIPMENT SUBMITTALS TO ARCHITECT FOR REVIEW.

**ELECTRICAL SCOPE OF WORK**

**GENERAL**

- PROVIDE NEW MAIN BUILDING ELECTRICAL METER.
- PROVIDE NEW MAIN AND BRANCH PANELING FOR ENTIRE BUILDING.
- PROVIDE INDIVIDUAL METERING SYSTEM FOR EACH TENANT SPACE.
- PROVIDE 100 AMP BRANCH PANEL IN EACH TENANT SPACE.
- PROVIDE LIGHTING AS SHOWN ON THE RCP FOR INTERIOR AND EXTERIOR SPACES; ALL LIGHTING TO BE LED WITH DIMMER SWITCHES WHERE INDICATED ON THE LIGHT FIXTURE SCHEDULE ON A111, A112, A113.
- VERIFY EGRESS LIGHTING AND ILLUMINATION LEVELS THROUGHOUT THE SPACES ARE ADEQUATE.
- FOLLOW ALL APPLICABLE CODES.
- OBTAIN ALL NECESSARY PERMITS AND INSPECTIONS APPLICABLE TO ELECTRICAL WORK.
- SUBMITTAL REQUIREMENTS:** ELECTRICAL CONTRACTOR TO PROVIDE LIGHTING PLANS, LUMINAIRE SCHEDULE, FIXTURE CUT SHEETS, DEVICES AND EQUIPMENT SUBMITTALS TO ARCHITECT FOR REVIEW.

**LEGEND - PLAN SYMBOLS**

**CALLOUTS**

	BUILDING SECTION SYMBOL, 1/A101 INDICATES DETAIL 1 CAN BE FOUND ON SHEET A101
	WALL SECTION SYMBOL, 1/A101 INDICATES DETAIL 1 CAN BE FOUND ON SHEET A101
	SECTION DETAIL SYMBOL, 1/A101 INDICATES DETAIL 1 CAN BE FOUND ON SHEET A101
	PLAN DETAIL OR ENLARGED PLAN SYMBOL, 1/A101 INDICATES DETAIL 1 CAN BE FOUND ON SHEET A101
	EXTERIOR ELEVATION SYMBOL, 1/A201 INDICATES DETAIL 1 CAN BE FOUND ON SHEET A201
	INTERIOR ELEVATION SYMBOL, 1/A401 INDICATES DETAIL 1 CAN BE FOUND ON SHEET A401
	VERTICAL OR SPOT ELEVATION
	1 HOUR FIRE RATED WALL
	FIRE EXTINGUISHER - SURFACE MOUNT
	FIRE EXTINGUISHER CABINET AND FIRE EXTINGUISHER - SEMI-RECESSED

**IDENTIFICATION**

	NEW CONSTRUCTION GRID LINE IDENTIFICATION
	EXISTING CONSTRUCTION GRID LINE IDENTIFICATION
	WALL TYPE IDENTIFICATION
	KEYED NOTE IDENTIFICATION
	WINDOW IDENTIFICATION
	REVISION IDENTIFICATION
	DOOR IDENTIFICATION
	ROOM NAME, NUMBER, AND SF AREA
	NORTH ARROW
	INDICATE FLOOR SLOPING TO DRAIN

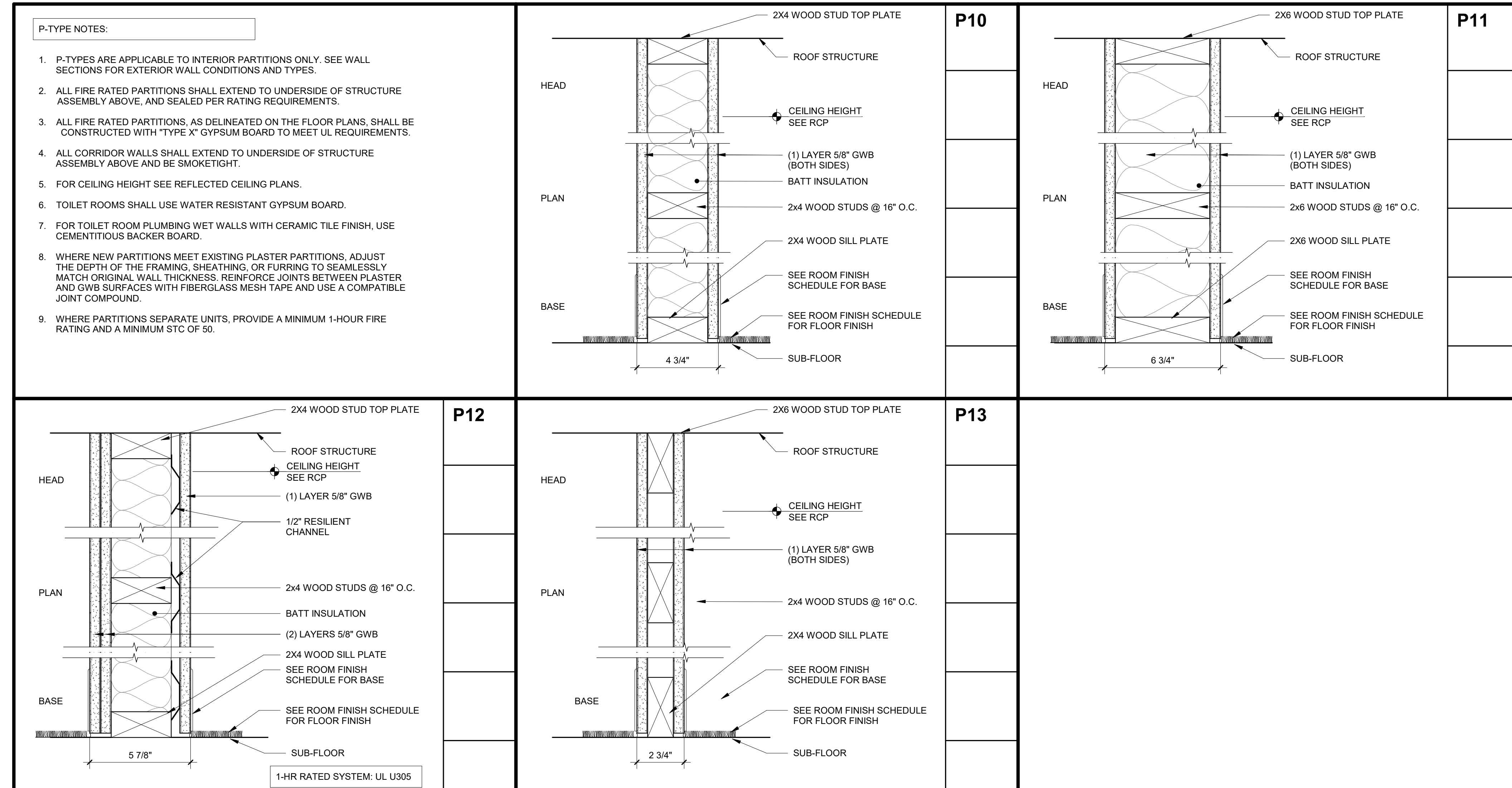

**1 PARTITION TYPES**  
3" = 1'-0"

No.	Description	Date

112 South Hancock Street

Madison, WI 53703

**NOTES, ABBREVIATIONS, PARTITION TYPES, MEP SCOPE**

CONSTRUCTION DOCUMENTS	
Project number	THA-22-01
Date	06/08/2023

**A001**

WOOD OR  
HOLLOW  
METAL

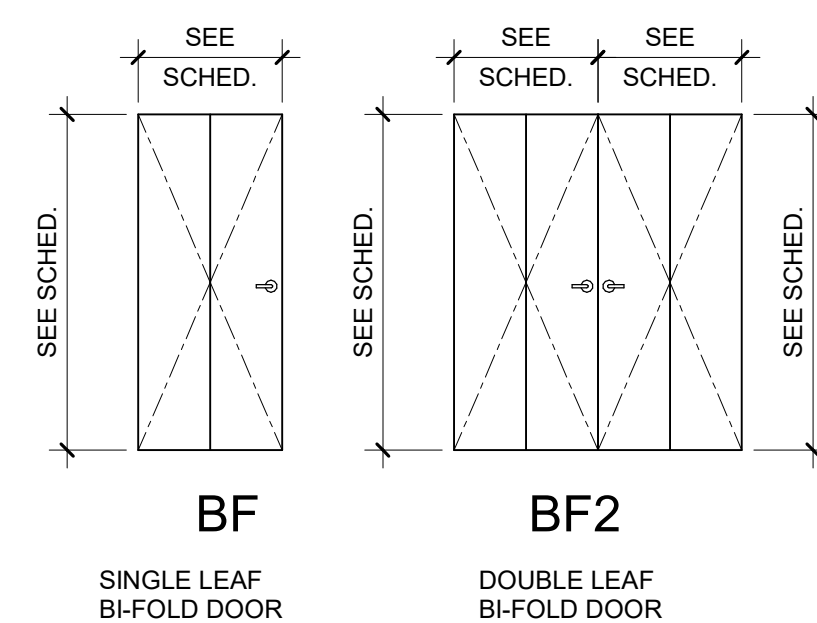
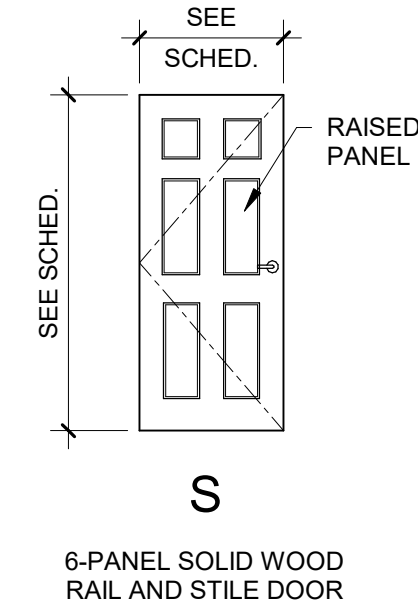
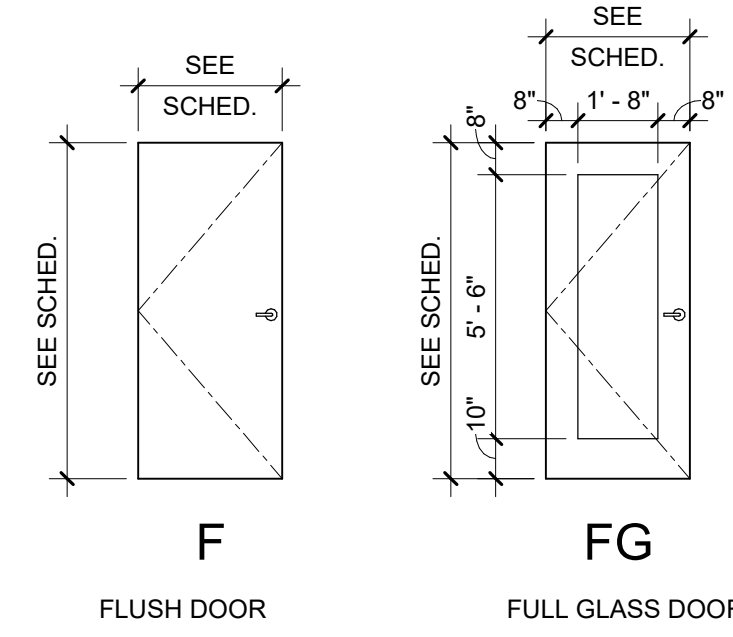

**1 DOOR TYPES**  
1/4" = 1'-0"

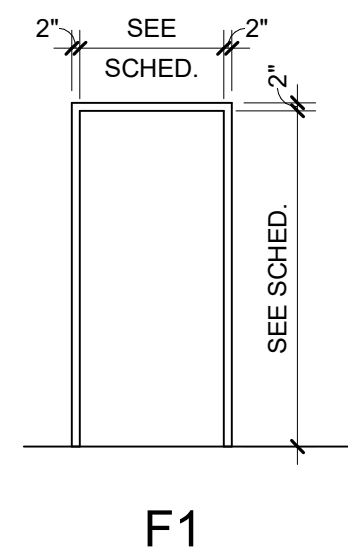

**2 FRAME TYPES**  
1/4" = 1'-0"

DOOR AND HARDWARE SCHEDULE

DOOR NUMBER	QTY.	DOOR										FRAME			MISCELLANEOUS		REMARKS	
		LEAF WIDTH 1	LEAF WIDTH 2	TOTAL WIDTH	HEIGHT	TYPE	MAT'L	GLAZING TYPE	FINISH	TYPE	MAT'L	DETAILS			FIRE RATING	HWDR SET		
												HEAD	JAMB	OTHER				
001	(1)	3'-0"		3'-0"	7'-0"	F	HM		PT-6	F1	HM						PT-6	
002	(1)	3'-0"		3'-0"	7'-0"	S	WD		STN-1	F1	WD						STN-1	
003	(1)	3'-0"		3'-0"	7'-0"	F	HM		PT-6	F1	HM						PT-6	
104	(1)	3'-0"		3'-0"	7'-6"	S	WD		STN-1	F1	WD						STN-1	
105	(1)	3'-0"		3'-0"	7'-6"	S	WD		STN-1	F1	WD						STN-1	
106	(4)	1'-3"		5'-0"	7'-0"	BF2	WD		STN-1	F1	WD						STN-1	
110	(2)	1'-3"		2'-6"	7'-0"	BF1	WD		STN-1	F1	WD						STN-1	
111	(1)	3'-0"		3'-0"	7'-0"	FG	WD		STN-1	F1	WD						STN-1	
112	(1)	3'-0"		3'-0"	7'-0"	S	WD		STN-1	F1	WD						STN-1	
113	(1)	2'-10"		2'-10"	7'-0"	S	WD		STN-1	F1	WD						STN-1	
114	(1)	2'-10"		2'-10"	7'-0"	S	WD		STN-1	F1	WD						STN-1	
115	(4)	1'-6"		6'-0"	7'-0"	BF2	WD		STN-1	F1	WD						STN-1	
116	(2)	1'-6"		3'-0"	7'-0"	BF1	WD		STN-1	F1	WD						STN-1	
117	(4)	1'-3"		5'-0"	7'-0"	BF2	WD		STN-1	F1	WD						STN-1	
202	(2)	1'-6"		3'-0"	7'-0"	BF1	WD		STN-1	F1	WD						STN-1	
204	(1)	2'-4"		2'-4"	7'-0"	S	WD		STN-1	F1	WD						STN-1	
208	(1)	2'-10"		2'-10"	7'-0"	S	WD		STN-1	F1	WD						STN-1	
209	(1)	2'-10"		2'-10"	7'-0"	S	WD		STN-1	F1	WD						STN-1	
210	(1)	3'-0"		3'-0"	7'-0"	S	WD		STN-1	F1	WD						STN-1	
211	(2)	1'-6"		3'-0"	7'-0"	BF1	WD		STN-1	F1	WD						STN-1	
212	(1)	3'-0"		3'-0"	7'-0"	S	WD		STN-1	F1	WD						STN-1	
220	(1)	3'-0"		3'-0"	7'-0"	S	WD		STN-1	F1	WD						STN-1	
221	(1)	3'-0"		3'-0"	7'-0"	FG	WD		STN-1	F1	WD						STN-1	
222	(1)	3'-0"		3'-0"	7'-0"	S	WD		STN-1	F1	WD						STN-1	
223	(1)	3'-0"		3'-0"	7'-0"	S	WD		STN-1	F1	WD						STN-1	
225	(1)	3'-0"		3'-0"	7'-0"	S	WD		STN-1	F1	WD						STN-1	
226	(4)	1'-3"		5'-0"	7'-0"	BF2	WD		STN-1	F1	WD						STN-1	
227	(4)	1'-6"		6'-0"	7'-0"	BF2	WD		STN-1	F1	WD						STN-1	
228	(2)	1'-4"		2'-8"	7'-0"	BF1	WD		STN-1	F1	WD						STN-1	
229	(4)	1'-0"		4'-0"	7'-0"	BF2	WD		STN-1	F1	WD						STN-1	
244	(4)	1'-3"		5'-0"	7'-0"	BF2	WD		STN-1	F1	WD						STN-1	
261	(2)	1'-6"		3'-0"	7'-0"	BF1	WD		STN-1	F1	WD						STN-1	
300	(1)	3'-0"		3'-0"	7'-0"	S	WD		STN-1	F1	WD						STN-1	
303	(1)	2'-10"		2'-10"	7'-0"	S	WD		STN-1	F1	WD						STN-1	
304	(1)	2'-10"		2'-10"	7'-0"	S	WD		STN-1	F1	WD						STN-1	
305	(1)	2'-10"		2'-10"	7'-0"	S	WD		STN-1	F1	WD						STN-1	
306	(1)	2'-10"		2'-10"	7'-0"	S	WD		STN-1	F1	WD						STN-1	
307	(1)	2'-10"		2'-10"	7'-0"	S	WD		STN-1	F1	WD						STN-1	
308	(1)	2'-10"		2'-10"	7'-0"	S	WD		STN-1	F1	WD						STN-1	
310	(4)	1'-3"		5'-0"	7'-0"	BF2	WD		STN-1	F1	WD						STN-1	
311	(1)	2'-10"		2'-10"	7'-0"	S	WD		STN-1	F1	WD						STN-1	
312	(2)	1'-6"		3'-0"	7'-0"	BF1	WD		STN-1	F1	WD						STN-1	
313	(1)	2'-10"		2'-10"	7'-0"	S	WD		STN-1	F1	WD						STN-1	
E1	(1)	3'-4"		3'-4"	7'-6"	FG	WD		STN-1	F1	WD						STN-1	
E2	(1)	3'-4"		3'-4"	7'-6"	FG	WD		STN-1	F1	WD						STN-1	
E3	(1)	3'-4"		3'-4"	7'-6"	FG	WD		STN-1	F1	WD						STN-1	
E4	(1)	2'-5 1/2"		2'-5 1/2"	7'-6"	S	WD		STN-1	F1	WD						STN-1	
E6	(2)	1'-9"		1'-9"	3'-6 5/8"	7'-2"												
E10	(2)	4'-0"		1'-0"	4'-1 1/16"	7'-2"												

DOOR AND HARDWARE SCHEDULE ABBREVIATIONS	DOOR AND HARDWARE SCHEDULE GENERAL NOTES
DOOR/FRAME MATERIALS AL = ALUMINUM EX = EXISTING HM = HOLLOW METAL SS = STAINLESS STEEL ST = STEEL WD = WOOD	1. schedule notes 2. 3.

**WINDOW GENERAL NOTES:**

- SCOPE OF WORK INVOLVES THE REHABILITATION OF A HISTORIC BUILDING. TREAT THE BUILDING RESPECTFULLY, CAREFULLY RESPECT EXISTING CONDITIONS AND TREAT EXISTING MATERIALS AS IRREPLACEABLE. DO NOT REMOVE, ALTER, OR DISFIGURE ANY EXISTING MATERIALS, ELEMENTS, OR FINISHES UNLESS INDICATED IN THE DRAWINGS OR SPECIFICATIONS OR DIRECTED BY THE ARCHITECT.
- ALL EXISTING WINDOWS TO REMAIN AS NOTED, WHERE POSSIBLE. CONDITIONS VARY FROM DAMAGED GLAZING, MISSING GLAZING, DAMAGED FRAME, MISSING FRAME, TO NON-ORIGINAL WINDOWS. CONTRACTOR TO PERFORM THOROUGH CONDITION ASSESSMENT FOR ALL WINDOWS TO DETERMINE LEVEL OF REPAIR, RESTORATION, OR REPLACEMENT NEEDED. NEW WINDOWS TO MATCH APPEARANCE (TRIM PROFILE, MOLDING STYLE) SIZE, AND OPERATION OF EXISTING WINDOWS.
- MANUFACTURER BASIS OF DESIGN FOR NEW WINDOWS: MARVIN ULTIMATE CLAD WINDOWS.
- EXTERIOR CLADDING FINISH: TBD. INTERIOR FINISH: TBD.
- OPENING SIZES PROVIDED ARE APPROXIMATE FOR EACH WINDOW TYPE. CONTRACTOR IS RESPONSIBLE FOR FIELD VERIFYING EVERY OPENING. DIMENSIONAL TOLERANCES SHALL MEET ALL REQUIREMENTS FOR PERIMETER SEALANT JOINT.
- FIELD VERIFYING OF ALL DIMENSIONS AND EXISTING CONDITIONS IS THE SOLE RESPONSIBILITY OF THE CONTRACTOR.
- REFER TO BUILDING ELEVATIONS FOR WINDOW LOCATIONS, TYPES, AND QUANTITIES.
- SCOPE OF WORK INVOLVES REMOVAL AND REPLACEMENT OF EXTERIOR WINDOWS AND DOORS.
- EXISTING WINDOW UNITS ARE LIKELY TO BE PAINTED WITH LEAD-BASED PAINTS. CONTRACTOR SHALL BE RESPONSIBLE FOR TAKING PRECAUTIONS AND COMPLYING WITH ALL REGULATIONS.
- CONTRACTOR IS RESPONSIBLE FOR PROTECTING OPENINGS DURING CONSTRUCTION TO MAINTAIN A WEATHER TIGHT BUILDING ENCLOSURE AND PREVENT UNAUTHORIZED ENTRY.
- EXISTING WINDOW GLAZING COMPOUND, CAULKING AND SEALANTS ARE ASSUMED TO CONTAIN ASBESTOS. CONTRACTOR REMOVING EXISTING CAULKING AND/OR WINDOWS & DOORS SHALL COMPLY WITH WISCONSIN ADMINISTRATIVE CODE CHAPTER DEPARTMENT OF HEALTH SERVICES 159-CERTIFICATION AND TRAINING REQUIREMENTS FOR ASBESTOS ACTIVITIES.

WINDOW SCHEDULE									
TYPE MARK	COUNT	WIDTH	HEIGHT	WINDOW TYPE	LEVEL	SILL HEIGHT	HEAD HEIGHT	OPERATION	REMARKS
EXISTING									
A	8	2'-10"	5'-6"	EXISTING WOOD WINDOW	FIRST FLOOR	2'-2"	7'-8"	DOUBLE HUNG	1, 2, 3
B	1	3'-6"	5'-6"	EXISTING WOOD WINDOW	FIRST FLOOR	2'-2"	7'-8"	DOUBLE HUNG	1, 2, 3
C	1	3'-11"	2'-9 1/2"	EXISTING WOOD WINDOW	FIRST FLOOR	4'-10 1/2"	7'-8"	FIXED	1, 2, 3
D	1	1'-7"	3'-0"	EXISTING SKYLIGHT	THIRD FLOOR			SKYLIGHT	1, 2, 3
E	1	2'-10"	4'-6"	EXISTING WOOD WINDOW	FIRST FLOOR	3'-2"	7'-8"	DOUBLE HUNG	1, 2, 3
F	1	4'-0"	5'-0"	EXISTING WOOD WINDOW	FIRST FLOOR	3'-2"	8'-2"	DOUBLE HUNG	1, 2, 3
G	1	3'-0"	5'-0"	EXISTING WOOD WINDOW	FIRST FLOOR	2'-8"	7'-8"	DOUBLE HUNG	1, 2, 3
H	2	2'-0"	7'-9"	EXISTING WOOD WINDOW	FIRST FLOOR	4'-6"	12'-3"	DOUBLE HUNG	1, 2, 3
K	7	2'-10"	5'-0"	EXISTING WOOD WINDOW	SECOND FLOOR	2'-2"	7'-2"	DOUBLE HUNG	1, 2, 3
L	1	3'-4"	5'-0"	EXISTING WOOD WINDOW	SECOND FLOOR	2'-2"	7'-2"	DOUBLE HUNG	1, 2, 3
M	1	2'-10"	4'-0"	EXISTING WOOD WINDOW	SECOND FLOOR	3'-2"	7'-2"	DOUBLE HUNG	1, 2, 3
N	2	3'-0"	5'-0"	EXISTING WOOD WINDOW	SECOND FLOOR	2'-2"	7'-2"	DOUBLE HUNG	1, 2, 3
P	1	3'-4"	5'-0"	EXISTING WOOD WINDOW	SECOND FLOOR	2'-2"	7'-2"	DOUBLE HUNG	1, 2, 3
NEW									
Q	4	2'-9 3/8"	4'-1"	MARVIN ULTIMATE CLAD	<varies>	<varies>	<varies>	DOUBLE HUNG	4
R	1	3'-5 3/8"	5'-1"	MARVIN ULTIMATE CLAD	SECOND FLOOR	2'-1"	7'-2"	DOUBLE HUNG	4
S	2	3'-11"	2'-9 1/2"	MARVIN ULTIMATE CLAD	SECOND FLOOR	4'-4 1/2"	7'-2"	FIXED	4
T	6	2'-7 3/8"	4'-5"	MARVIN ULTIMATE CLAD	THIRD FLOOR	2'-6"	6'-11"	DOUBLE HUNG	4
U	2	2'-7 3/8"	4'-1"	MARVIN ULTIMATE CLAD	THIRD FLOOR	3'-4"	7'-5"	DOUBLE HUNG	4
V	1	2'-9 3/8"	4'-1"	MARVIN ULTIMATE CLAD	FIRST FLOOR	3'-7"	7'-8"	DOUBLE HUNG	4
W	4	2'-11 3/8"	3'-5"	MARVIN ULTIMATE CLAD	THIRD FLOOR	3'-6"	6'-11"	DOUBLE HUNG	4
Y	1	3'-11"	2'-9 1/2"	MARVIN ULTIMATE CLAD	FIRST FLOOR	4'-10 1/2"	7'-8"	DOUBLE HUNG	4
Z	1	2'-9 3/8"	4'-1"	MARVIN ULTIMATE CLAD	SECOND FLOOR	3'-1"	7'-2"	DOUBLE HUNG	4

REMARKS
1. EXISTING WINDOW TO REMAIN, IF EXISTING WINDOW IS DAMAGED BEYOND REPAIR, REPLACE WITH NEW WINDOW.
2. RESTORE ANY MINOR DAMAGE TO EXISTING WINDOWS SUCH AS ROT OR MISSING WOOD. REMOVE ALL EXISTING FINISH AND PREP AND REPAINT EXISTING WINDOWS. SEE "WINDOW GENERAL NOTES".
3. REPAIR OR REPLACE DAMAGED OR MISSING STORM WINDOWS.
4. NEW WINDOW, PROVIDE STORM WINDOW.
5. NEW WINDOW DIMENSIONS INDICATE FRAME SIZE OF MARVIN ULTIMATE CLAD WINDOWS.

No.	Description	Date

112 South Hancock Street

Madison, WI 53703

**DOOR SCHEDULE AND WINDOW SCHEDULE**

CONSTRUCTION DOCUMENTS	
Project number	THA-22-01
Date	06/08/2023

A002

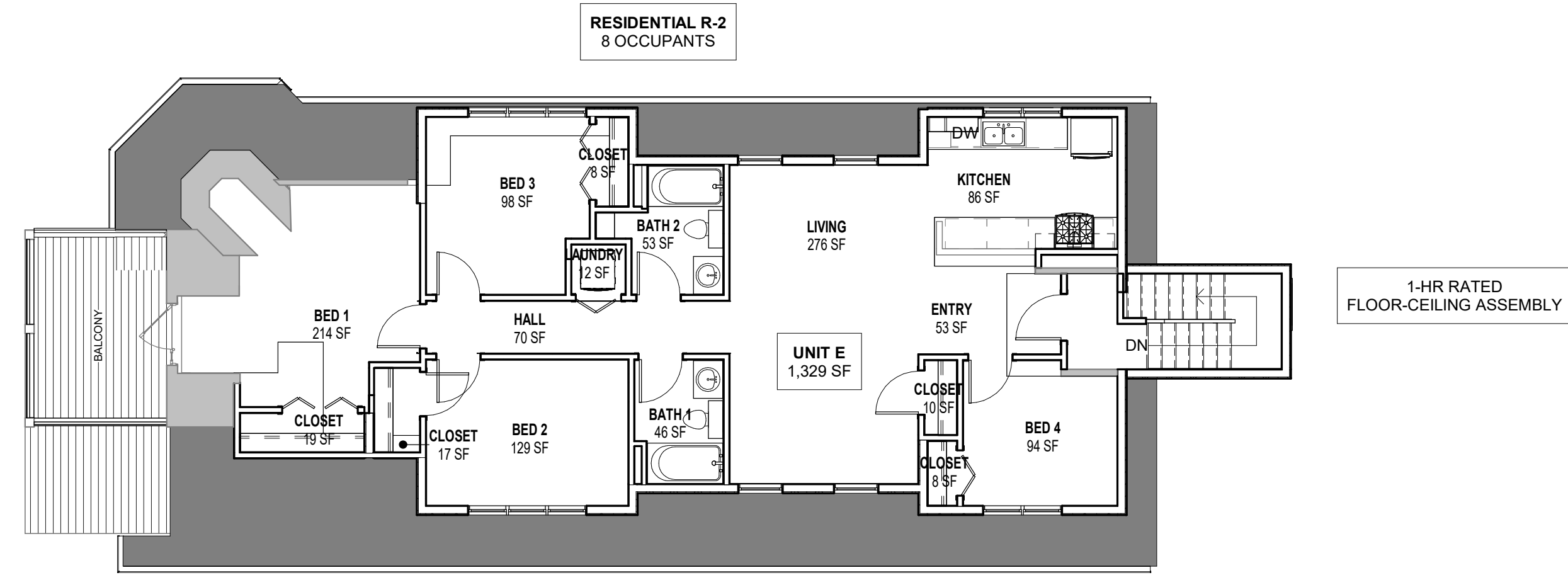

**THIRD FLOOR PLAN - CODE**  
1/8" = 1'-0"

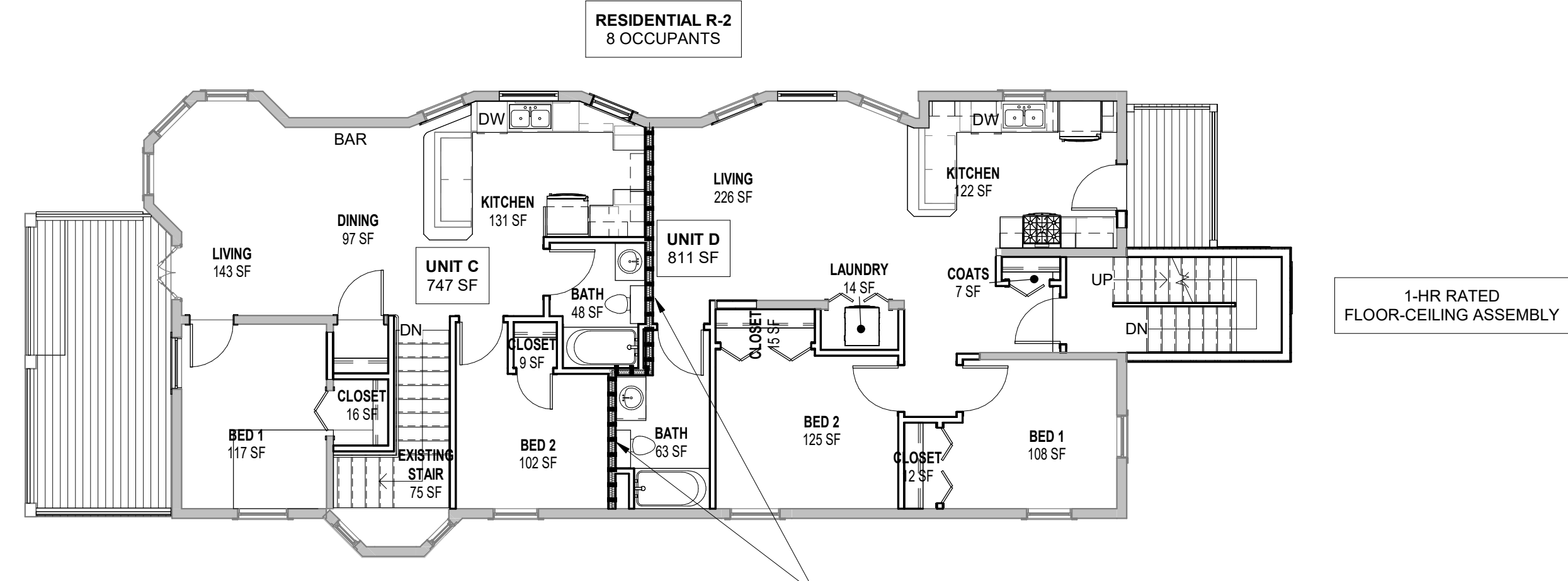

**SECOND FLOOR PLAN - CODE**  
1/8" = 1'-0"

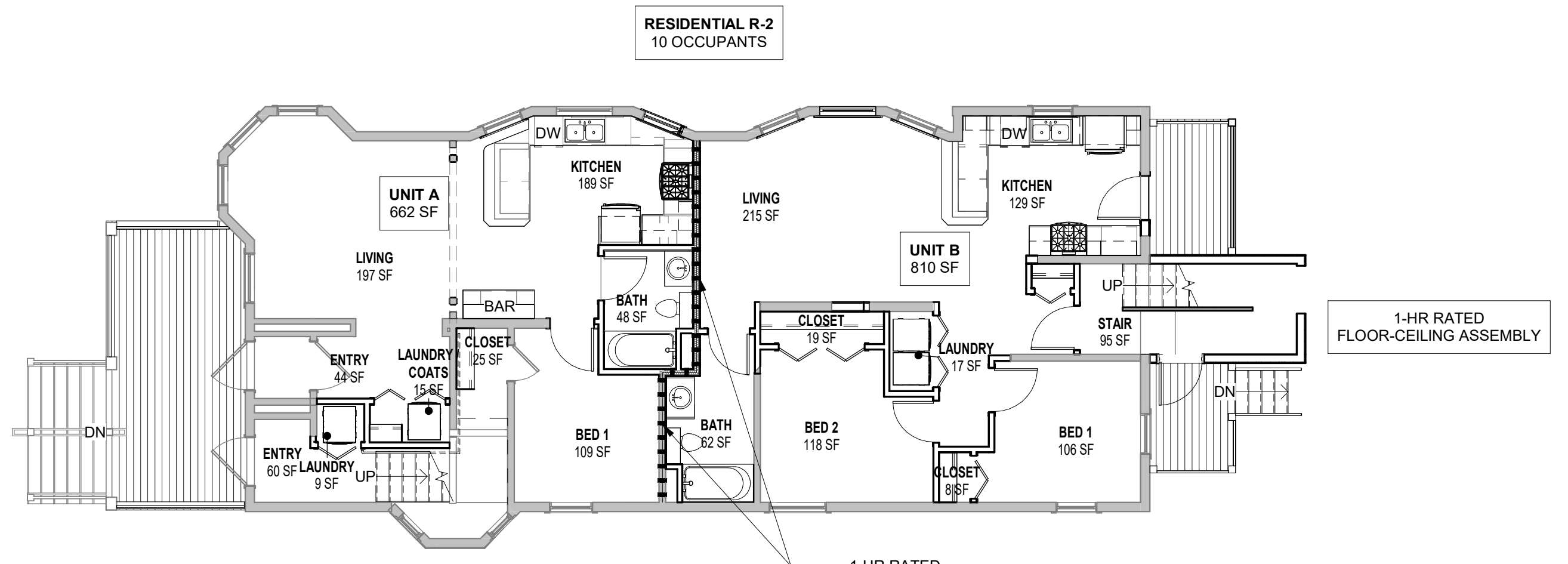

**FIRST FLOOR PLAN - CODE**  
1/8" = 1'-0"

**CODE ANALYSIS:**

**APPLICABLE CODES:**  
WISCONSIN COMMERCIAL BUILDING CODE 2018 - EFFECTIVE MAY 1, 2018 (BASED ON 2015 INTERNATIONAL BUILDING CODE WITH WISCONSIN AMENDMENTS - SPS 361 & 362)  
2015 INTERNATIONAL EXISTING BUILDING CODE (IEBC)  
2015 INTERNATIONAL ENERGY CONSERVATION CODE WITH WISCONSIN AMENDMENTS (SPS 363)  
2015 INTERNATIONAL MECHANICAL CODE WITH WISCONSIN AMENDMENTS (SPS 364)  
2015 INTERNATIONAL FUEL GAS CODE WITH WISCONSIN AMENDMENTS (SPS 365)  
2009 WISCONSIN PLUMBING CODE - SPS 381-387  
WISCONSIN STATE ELECTRICAL CODE - SPS 316

**BUILDING USE AND OCCUPANCY CLASSIFICATION:**  
GROUP R-2

**CONSTRUCTION TYPE:**  
TYPE VB FULL BUILDING SPRINKLERED

**WORK AREA:**  
ALTERATION LEVEL 3

**PROJECT WORK AREA =**  
BASEMENT = 1,822 SF  
FIRST FLOOR = 1,858 SF  
SECOND FLOOR = 1,585 SF  
THIRD FLOOR = 1,500 SF

**RATED CONSTRUCTION:**  
PRIMARY STRUCTURAL FRAME: 0  
BEARING WALLS: 0  
FLOOR CONSTRUCTION: 0  
ROOF CONSTRUCTION: 0

**OCCUPANT LOAD:**  
RESIDENTIAL = 200 GSF PER OCCUPANT  
BASEMENT S OCCUPANCY = 0 OCCUPANTS  
FIRST FLOOR R2 OCCUPANCY = 10 OCCUPANTS  
SECOND FLOOR R2 OCCUPANCY = 8 OCCUPANTS  
THIRD FLOOR R2 OCCUPANCY = 8 OCCUPANTS

**TOTAL: 26 OCCUPANTS**

**FIRE SEPARATIONS:**  
HORIZONTAL SEPARATION BETWEEN R OCCUPANCIES: 1 HOUR (TABLE 508.4 & 711.2.4)

**ACCESSIBILITY**

SECTION 1107.7 - GENERAL EXCEPTIONS. WHERE SPECIFICALLY PERMITTED BY SECTION 1107.5 OR 1107.6, THE REQUIRED NUMBER OF TYPE A UNITS AND TYPE B UNITS IS PERMITTED TO BE REDUCED IN ACCORDANCE WITH SECTIONS 1107.7.1 THROUGH 1107.7.5.

SECTION 1107.7.1 STRUCTURES WITHOUT ELEVATOR SERVICE. WHERE NO ELEVATOR SERVICE IS PROVIDED IN A STRUCTURE, ONLY THE DWELLING UNITS AND SLEEPING UNITS THAT ARE LOCATED ON STORIES INDICATED IN SECTIONS 1107.7.1.1 AND 1107.7.1.2 ARE REQUIRED TO BE TYPE A UNITS AND TYPE B UNITS, RESPECTIVELY. THE NUMBER OF TYPE A UNITS SHALL BE DETERMINED IN ACCORDANCE WITH SECTION 1107.6.2.2.1.

IEBC SECTION 705. A FACILITY THAT IS ALTERED SHALL COMPLY WITH THE APPLICABLE PROVISIONS IN SECTIONS 705.1.1 THROUGH 705.1.14 AND CHAPTER 11 OF THE IBC UNLESS IT IS TECHNICALLY INFEASIBLE. WHERE COMPLIANCE WITH THIS SECTION IS TECHNICALLY INFEASIBLE, THE ALTERATION SHALL PROVIDE ACCESS TO THE MAXIMUM EXTENT THAT IS TECHNICALLY FEASIBLE.

IEBC SECTION 410.9 - HISTORIC BUILDINGS. THESE PROVISIONS SHALL APPLY TO FACILITIES DESIGNATED AS HISTORIC STRUCTURES THAT UNDERGO ALTERATIONS, UNLESS TECHNICALLY INFEASIBLE. WHERE COMPLIANCE WITH THE REQUIREMENTS FOR ACCESSIBLE ROUTES, ENTRANCES, OR TOILET ROOMS WOULD THREATEN OR DESTROY THE HISTORIC SIGNIFICANCE OF THE FACILITY, AS DETERMINED BY THE APPLICABLE GOVERNING AUTHORITY, THE ALTERNATIVE REQUIREMENTS OF SECTIONS 410.9.1-410.9.4 SHALL BE PERMITTED.

EXCEPTION: TYPE B DWELLING OR SLEEPING UNITS REQUIRED BY SECTION 1107 IBC ARE NOT REQUIRED TO BE PROVIDED IN HISTORICAL BUILDINGS.

THE HISTORIC CHARACTER OF THE BUILDING MAY BE ADVERSELY AFFECTED IF AN ACCESSIBLE RAMP IS ADDED TO THE MAIN ENTRY.

SITE RESTRICTIONS MAKE ADDING AN ACCESSIBLE RAMP AT THE REAR OF THE BUILDING THAT PROVIDES AN ACCESSIBLE ROUTE FROM GRADE TO THE FIRST FLOOR LEVEL (32" HEIGHT CHANGE, REQUIRING 32 FEET OF RAMP LENGTH PLUS LANDINGS) OF THE BUILDING TECHNICALLY INFEASIBLE.

SINCE ADDING AN ACCESSIBLE ROUTE OR ELEVATOR TO ACCESS DWELLING UNITS ON THE FIRST FLOOR OR UPPER FLOORS OF THE BUILDING IS TECHNICALLY INFEASIBLE, DWELLING UNITS ARE NOT REQUIRED TO MEET TYPE A/TYPE B ACCESSIBILITY CRITERIA.

SECTION 420.2 - SEPARATION WALLS. WALLS SEPARATING DWELLING UNITS IN THE SAME BUILDING, WALLS SEPARATING SLEEPING UNITS IN THE SAME BUILDING AND WALLS SEPARATING DWELLING OR SLEEPING UNITS FROM OTHER OCCUPANCIES CONTIGUOUS TO THEM IN THE SAME BUILDING SHALL BE CONSTRUCTED AS FIRE PARTITIONS IN ACCORDANCE WITH SECTION 708. FIRE PARTITIONS SHALL HAVE A FIRE-RESISTANCE RATING OF NOT LESS THAN 1 HOUR (420.2, 708.3)

SECTION 420.3 - HORIZONTAL SEPARATION. FLOOR ASSEMBLIES SEPARATING DWELLING UNITS IN THE SAME BUILDINGS, FLOOR ASSEMBLIES SEPARATING SLEEPING UNITS IN THE SAME BUILDING AND FLOOR ASSEMBLIES SEPARATING DWELLING OR SLEEPING UNITS FROM OTHER OCCUPANCIES CONTIGUOUS TO THEM IN THE SAME BUILDING SHALL BE CONSTRUCTED AS HORIZONTAL ASSEMBLIES IN ACCORDANCE WITH SECTION 711.

SECTION 420.5 - AUTOMATIC SPRINKLER SYSTEM GROUP R OCCUPANCIES SHALL BE EQUIPPED THROUGHOUT WITH AN AUTOMATIC SPRINKLER SYSTEM IN ACCORDANCE WITH SECTION 903.2.8.

**MEANS OF EGRESS:**

SECTION 1006.2.1 - EXCEPTION 1. IN GROUP R-2 OCCUPANCIES, ONE MEANS OF EGRESS IS PERMITTED WITHIN AND FROM INDIVIDUAL DWELLING UNITS WITH A MAXIMUM OCCUPANT LOAD OF 20 WHERE THE DWELLING UNIT IS EQUIPPED THROUGH-OUT WITH AN AUTOMATIC SPRINKLER SYSTEM IN ACCORDANCE WITH SECTION 903.3.1.1 OR 903.3.1.2 AND THE COMMON PATH OF EGRESS TRAVEL DOES NOT EXCEED 125 FEET (38 100 MM).

SECTION 1006.3.2 - A SINGLE EXIT OR ACCESS TO A SINGLE EXIT SHALL BE PERMITTED FROM ANY STORY OR OCCUPIED ROOF WHERE ONE OF THE FOLLOWING CONDITIONS EXIST: 1) THE OCCUPANT LOAD, NUMBER OF DWELLING UNITS AND THE COMMON PATH OF EGRESS TRAVEL DISTANCE DOES NOT EXCEED THE VALUES IN TABLE 1006.3.2(1) (4 DWELLING UNITS; 125 FEET)

SECTION 1017.2 - EXIT ACCESS TRAVEL DISTANCE. OCCUPANCY R2 = 250 FT W/ SPRINKLER

**SOUND TRANSMISSION:**

SECTION 1207.2 - AIR-BORNE SOUND. WALLS, PARTITIONS AND FLOOR/CEILING ASSEMBLIES SEPARATING DWELLING UNITS AND SLEEPING UNITS FROM EACH OTHER OR FROM PUBLIC OR SERVICE AREAS SHALL HAVE A SOUND TRANSMISSION CLASS OF NOT LESS THAN 50, OR NOT LESS THAN 45 IF FIELD TESTED, FOR AIR-BORNE NOISE WHEN TESTED IN ACCORDANCE WITH ASTM E90. PENETRATIONS OR OPENINGS IN CONSTRUCTION ASSEMBLIES FOR PIPING, ELECTRICAL DEVICES, RECESSED CABINETS, BATHTUBS, SOFFITS, OR HEATING, VENTILATING OR EXHAUST DUCTS SHALL BE SEALED, LINED, INSULATED OR OTHERWISE TREATED TO MAINTAIN THE REQUIRED RATINGS. THIS REQUIREMENT SHALL NOT APPLY TO ENTRANCE DOORS; HOWEVER, SUCH DOORS SHALL BE TIGHT FITTING TO THE FRAME AND SILL.

SECTION 1207.3 - STRUCTURE-BORNE SOUND. FLOOR/CEILING ASSEMBLIES BETWEEN DWELLING UNITS AND SLEEPING UNITS OR BETWEEN A DWELLING UNIT OR SLEEPING UNIT AND A PUBLIC OR SERVICE AREA WITHIN THE STRUCTURE SHALL HAVE AN IMPACT INSULATION CLASS RATING OF NOT LESS THAN 50, OR NOT LESS THAN 45 IF FIELD TESTED, WHEN TESTED IN ACCORDANCE WITH ASTM E492.

No.	Description	Date

**112 South Hancock Street**  
Madison, WI 53703  
**CODE ANALYSIS AND CODE PLANS**

CONSTRUCTION DOCUMENTS

Project number	THA-22-01
Date	06/08/2023

**LOT INFORMATION:**  
**LOT AREA:** 5187 S.F.  
**IMPERVIOUS AREA/BUILDING:** 3861 S.F.  
**PERVIOUS AREA:** 1326 S.F.  
**LOT COVERAGE:** 74.4%  
**SIDE YARD SETBACK FOR NEW CONSTRUCTION:**  
 10% OF LOT WIDTH  
 3.9 FEET / 39 FOOT LOT WIDTH  
**NEW DORMERS ON WEST ELEVATION AT THIRD FLOOR NEED TO BE SET BACK 3.9 FEET FROM THE LOT LINE.**

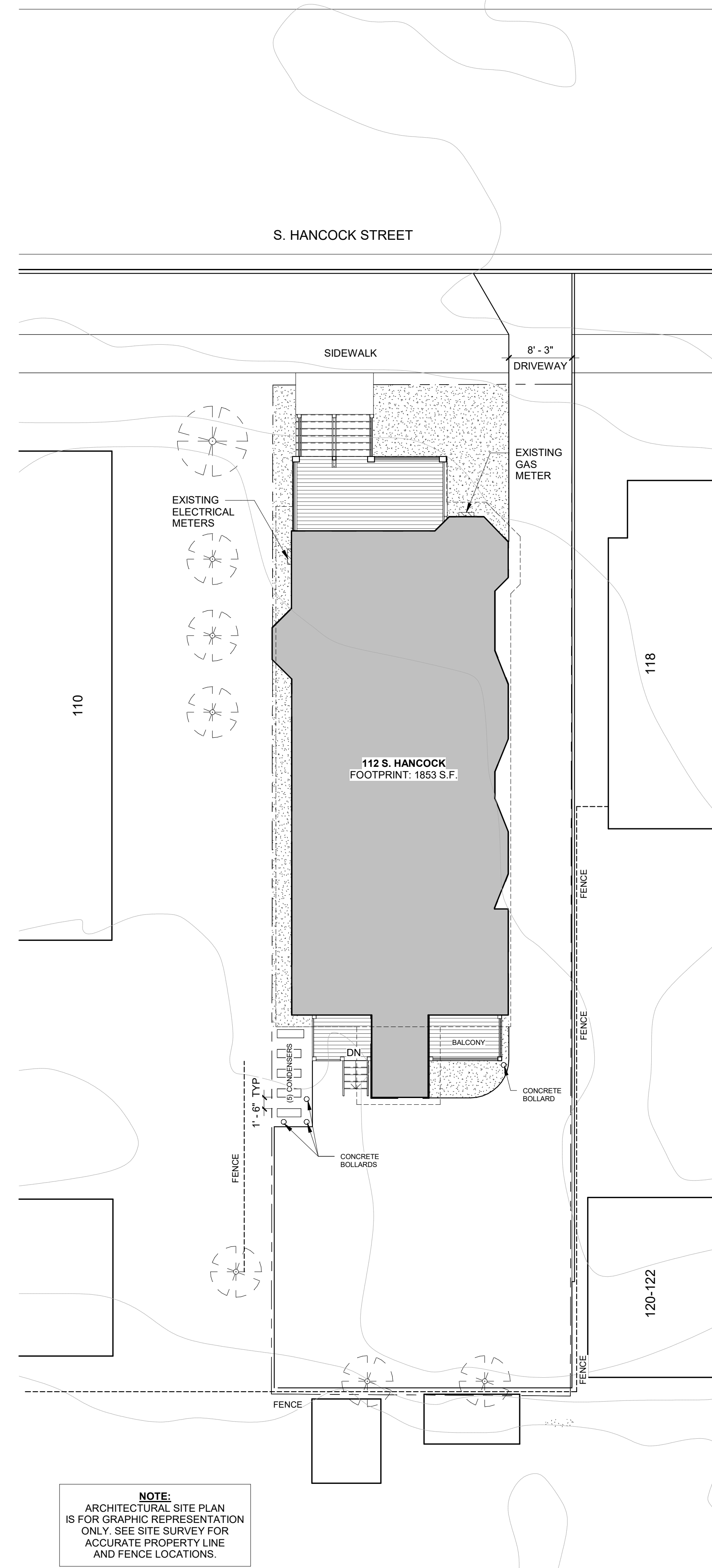
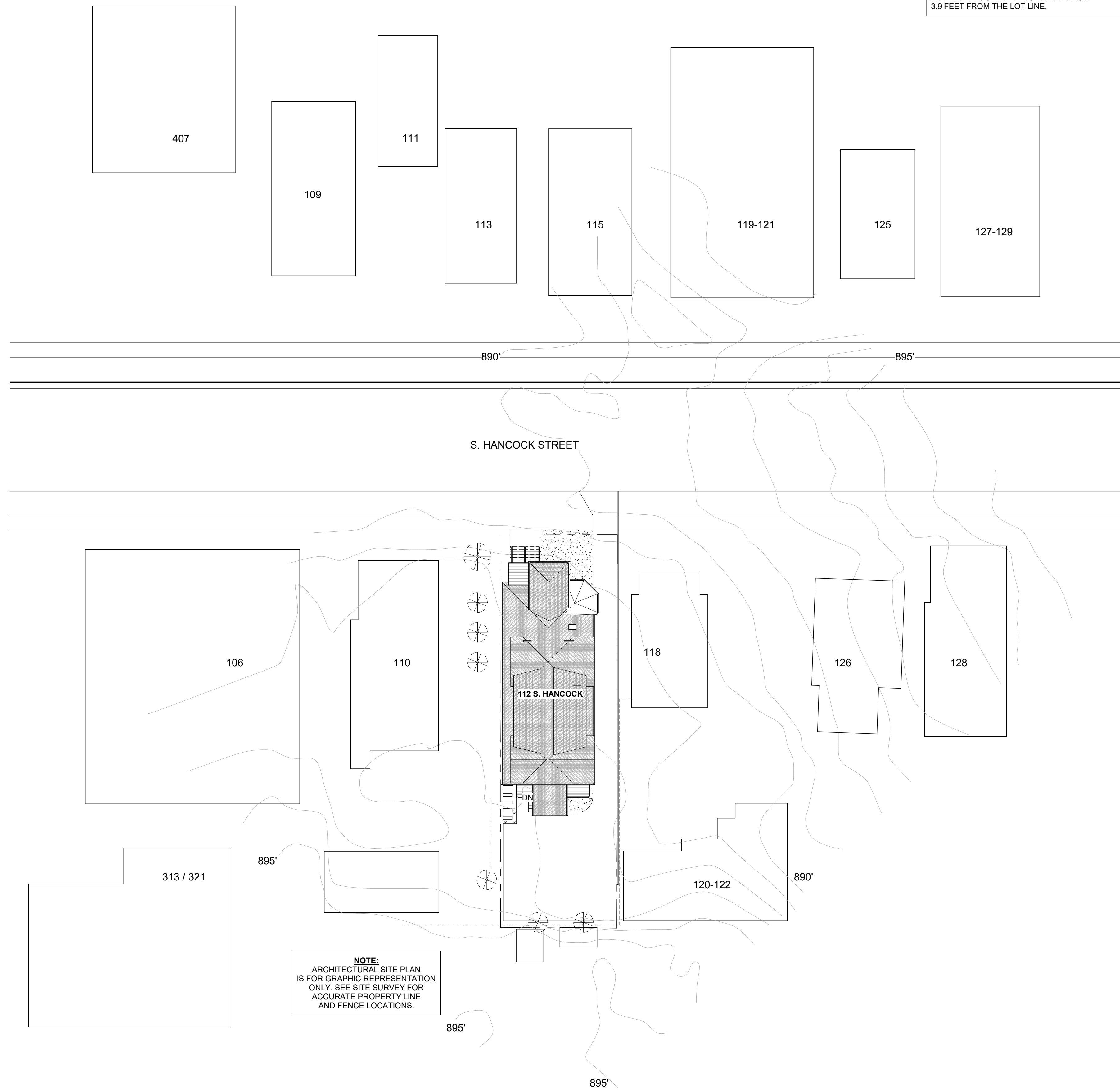

No.	Description	Date

**112 South Hancock Street**

Madison, WI 53703

**ARCHITECTURAL SITE PLAN**

CONSTRUCTION DOCUMENTS	
Project number	THA-22-01
Date	06/08/2023

**A010**

NORTH  
  
**1 SITE PLAN - OVERALL**  
 1" = 20'-0"

NORTH  
  
**2 SITE PLAN - ENLARGED**  
 1" = 10'-0"

**DEMOLITION GENERAL NOTES:**

- SCOPE OF WORK INVOLVES THE REHABILITATION OF A HISTORIC BUILDING. TREAT THE BUILDING RESPECTFULLY. CAREFULLY RESPECT EXISTING CONDITIONS AND TREAT EXISTING MATERIALS AS IRREPLACEABLE. DO NOT REMOVE, ALTER, OR DISFIGURE ANY EXISTING MATERIALS, ELEMENTS, OR FINISHES UNLESS INDICATED IN THE DRAWINGS OR SPECIFICATIONS OR DIRECTED BY THE ARCHITECT.
- FIELD VERIFY ALL DIMENSIONS. BRING ANY DISCREPANCIES TO THE ATTENTION OF THE ARCHITECT / ENGINEER FOR FINAL DECISION.
- REPAIR ALL WALLS AND FINISHES DISTURBED DURING DEMOLITION THAT ARE TO REMAIN.
- ALL EXISTING LIGHT FIXTURES ARE TO BE REMOVED.
- PROVIDE SHORING OF EXISTING STRUCTURAL WALL AND ROOF MEMBERS PRIOR TO THE COMMENCEMENT OF ASSOCIATED DEMOLITION OPERATIONS.
- PROVIDE FLOOR CUTTING/DEMOLITION AS NEEDED TO ROUTE EXISTING PLUMBING TO NEW PLUMBING FIXTURES. PATCH WOOD FLOORS AFTER WORK IS COMPLETE.
- ALL EXISTING WALLS TO REMAIN ARE SHOWN SHADED GRAY.
- CONTRACTORS ARE RESPONSIBLE FOR MAINTAINING CONTINUOUS UTILITY SERVICE TO ALL SPACES IN THE BUILDING NOT AFFECTED BY THIS WORK. ANY DISRUPTION IN SERVICE REQUIRED TO PERFORM WORK OR TO MODIFY EXISTING DUCTWORK, PIPING, CONDUIT, CIRCUITS OR ANY ASSOCIATED EQUIPMENT, MUST BE COORDINATED IN ADVANCE WITH THE OWNER/USER.
- PROVIDE SLAB CUTTING/DEMOLITION AS NEEDED TO ROUTE PLUMBING TO NEW PLUMBING FIXTURES. PATCH CONCRETE FLOORS AFTER WORK IS COMPLETE.
- ALL EXISTING WINDOWS TO REMAIN AS NOTED. WHERE POSSIBLE, CONTRACTOR TO PERFORM THOROUGH CONDITION ASSESSMENT FOR ALL WINDOWS TO DETERMINE LEVEL OF REPAIR, RESTORATION, OR REPLACEMENT NEEDED. NEW WINDOWS TO MATCH PROFILE OF EXISTING WINDOWS.
- REMOVE ALL WINDOW AIR CONDITIONING UNITS.

**DEMOLITION PLAN SYMBOL LEGEND**

- EXISTING PARTITION TO REMAIN
- EXISTING PARTITION TO BE REMOVED
- EXISTING DOOR TO REMAIN
- EXISTING DOOR TO BE REMOVED
- EXISTING ITEM TO REMAIN
- EXISTING ITEM TO BE REMOVED
- KEYED NOTE IDENTIFICATION

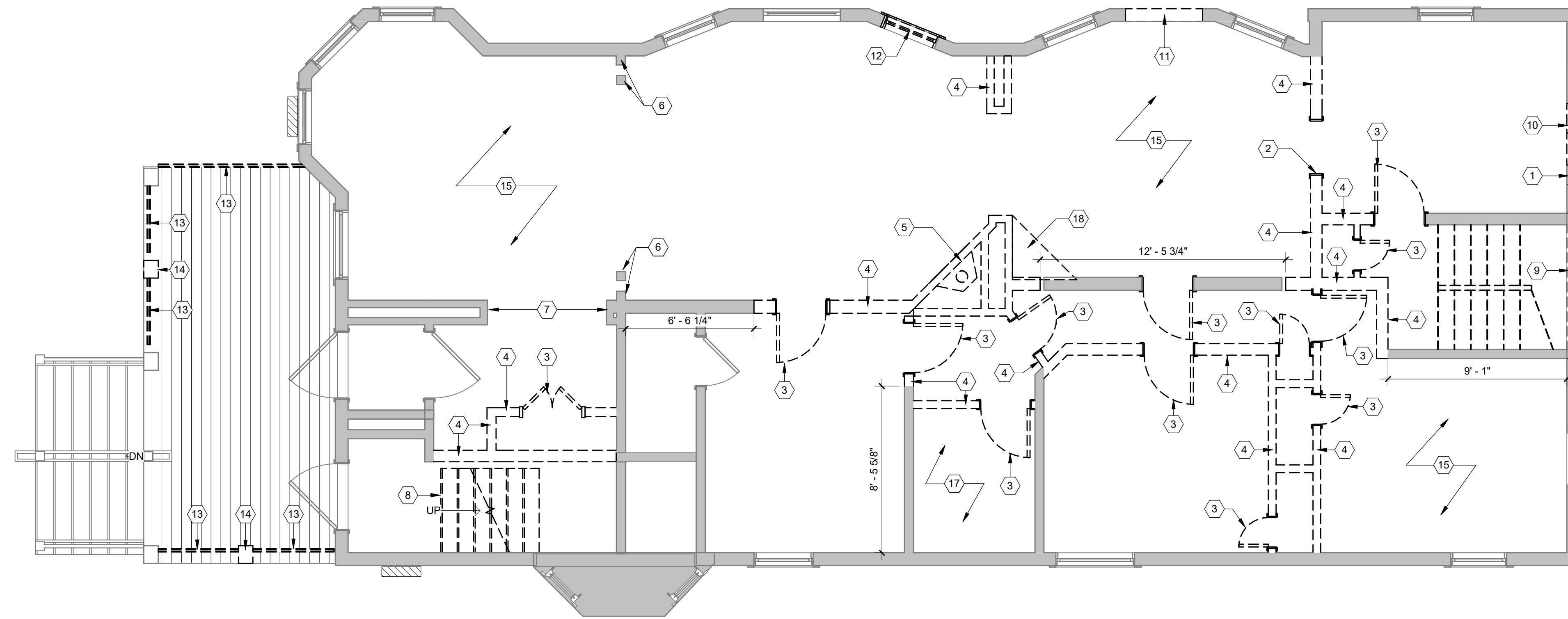

NORTH  
**1** FIRST FLOOR DEMOLITION PLAN  
1/4" = 1'-0"

**KEYED NOTES** #

1	REMOVE WINDOW AS SHOWN
2	REMOVE OPENING AS SHOWN
3	REMOVE DOOR AND FRAME AS SHOWN
4	REMOVE STUD WALL AND PLASTER AS SHOWN
5	REMOVE FIREPLACE AND ASSOCIATED FINISHES AND DUCTWORK
6	EXISTING WOOD COLUMNS AND TRIM TO REMAIN
7	EXISTING POCKET DOOR TO REMAIN
8	REMOVE PORTION OF EXISTING FOUNDATION WALL AS SHOWN, PROVIDE NEW STEEL HEADER AT OPENING
9	REMOVE PORTION OF EXTERIOR WALL AS SHOWN, PREP FOR STAIR ADDITION
10	REMOVE PORTION OF WALL AS SHOWN, PREP OPENING FOR NEW DOOR
11	REMOVE PORTION OF EXTERIOR WALL TO CUT OPENING FOR NEW WINDOW
12	REMOVE WINDOW, PREP OPENING FOR NEW OR RETROFITTED WINDOW
13	REMOVE RAILINGS AS SHOWN
14	REMOVE WOOD COLUMNS AND TRIM AS SHOWN
15	EXISTING HARDWOOD FLOORING TO REMAIN THROUGHOUT, PROTECT DURING CONSTRUCTION
16	REMOVE WOOD STAIR TREADS, RISERS, STRINGERS, RAILINGS AS SHOWN
17	REMOVE PLUMBING FIXTURES
18	REMOVE BUILT-IN CABINET
19	REMOVE CMU WALL AS SHOWN
20	REMOVE EXISTING BOILER AND ASSOCIATED PIPING
21	REMOVE FIREPLACE ASH DUMP

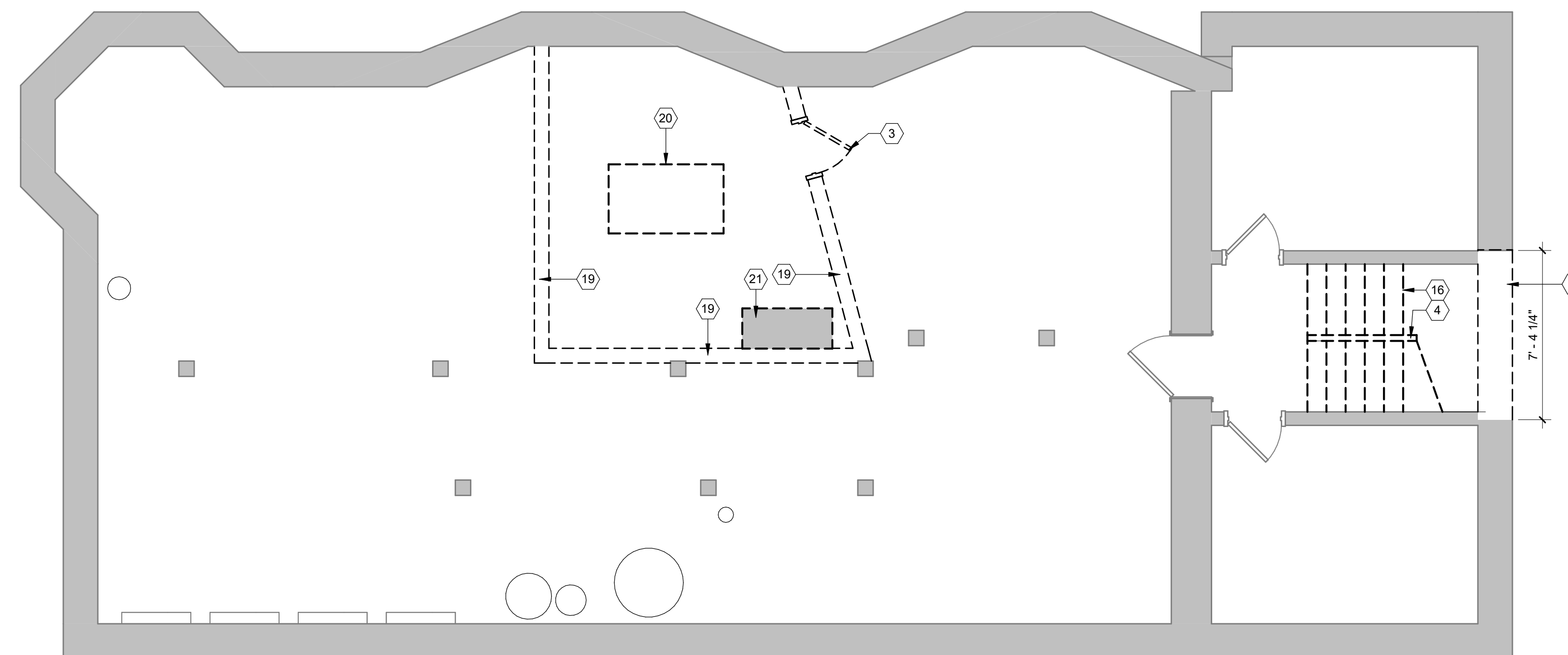

NORTH  
**2** BASEMENT DEMOLITION PLAN  
1/4" = 1'-0"

No.	Description	Date

112 South Hancock Street

Madison, WI 53703

**DEMOLITION PLANS**







CONSTRUCTION DOCUMENTS	
Project number	THA-22-01
Date	06/08/2023

**AD101**

**DEMOLITION GENERAL NOTES:**

1. SCOPE OF WORK INVOLVES THE REHABILITATION OF A HISTORIC BUILDING. TREAT THE BUILDING RESPECTFULLY. CAREFULLY RESPECT EXISTING CONDITIONS AND TREAT EXISTING MATERIALS AS IRREPLACEABLE. DO NOT REMOVE, ALTER, OR DISFIGURE ANY EXISTING MATERIALS, ELEMENTS, OR FINISHES UNLESS INDICATED IN THE DRAWINGS OR SPECIFICATIONS OR DIRECTED BY THE ARCHITECT.
2. FIELD VERIFY ALL DIMENSIONS. BRING ANY DISCREPANCIES TO THE ATTENTION OF THE ARCHITECT / ENGINEER FOR FINAL DECISION.
3. REPAIR ALL WALLS AND FINISHES DISTURBED DURING DEMOLITION THAT ARE TO REMAIN.
4. ALL EXISTING LIGHT FIXTURES ARE TO BE REMOVED.
5. PROVIDE SHORING OF EXISTING STRUCTURAL WALL AND ROOF MEMBERS PRIOR TO THE COMMENCEMENT OF ASSOCIATED DEMOLITION OPERATIONS.
6. PROVIDE FLOOR CUTTING/DEMOLITION AS NEEDED TO ROUTE EXISTING PLUMBING TO NEW PLUMBING FIXTURES. PATCH WOOD FLOORS AFTER WORK IS COMPLETE.
7. ALL EXISTING WALLS TO REMAIN ARE SHOWN SHADED GRAY.
8. CONTRACTORS ARE RESPONSIBLE FOR MAINTAINING CONTINUOUS UTILITY SERVICE TO ALL SPACES IN THE BUILDING NOT AFFECTED BY THIS WORK. ANY DISRUPTION IN SERVICE REQUIRED TO PERFORM WORK OR TO MODIFY EXISTING DUCTWORK, PIPING, CONDUIT, CIRCUITS OR ANY ASSOCIATED EQUIPMENT, MUST BE COORDINATED IN ADVANCE WITH THE OWNER/USER.
9. PROVIDE SLAB CUTTING/DEMOLITION AS NEEDED TO ROUTE PLUMBING TO NEW PLUMBING FIXTURES. PATCH CONCRETE FLOORS AFTER WORK IS COMPLETE.
10. ALL EXISTING WINDOWS TO REMAIN AS NOTED. WHERE POSSIBLE, CONTRACTOR TO PERFORM THOROUGH CONDITION ASSESSMENT FOR ALL WINDOWS TO DETERMINE LEVEL OF REPAIR, RESTORATION, OR REPLACEMENT NEEDED. NEW WINDOWS TO MATCH PROFILE OF EXISTING WINDOWS.
11. REMOVE ALL WINDOW AIR CONDITIONING UNITS.

**DEMOLITION PLAN SYMBOL LEGEND**

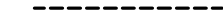
-  EXISTING PARTITION TO REMAIN
-  EXISTING PARTITION TO BE REMOVED
-  EXISTING DOOR TO REMAIN
-  EXISTING DOOR TO BE REMOVED
-  EXISTING ITEM TO REMAIN
-  EXISTING ITEM TO BE REMOVED
-  KEYED NOTE IDENTIFICATION

**KEYED NOTES #**

1	REMOVE DOOR AND FRAME AS SHOWN
2	REMOVE EXISTING PATIO FLOOR JOISTS, COLUMNS, RAILING, WOOD TRIM
3	REMOVE WOOD STAIR TREADS, RISERS, STRINGERS, RAILINGS AS SHOWN
4	REMOVE BRICK CHIMNEY
5	REMOVE RAILINGS AS SHOWN
6	REMOVE PLUMBING FIXTURES
7	EXISTING HARDWOOD FLOORING TO REMAIN THROUGHOUT, PROTECT DURING CONSTRUCTION
8	REMOVE STUD WALL AND PLASTER AS SHOWN
9	REMOVE PORTION OF WALL AS SHOWN, PREP OPENING FOR NEW DOOR
10	REMOVE PORTION OF EXTERIOR WALL TO CUT OPENING FOR NEW WINDOW
11	REMOVE WOOD COLUMNS AND TRIM AS SHOWN
12	REMOVE FIREPLACE AND ASSOCIATED FINISHES AND DUCTWORK
13	REMOVE WINDOW AS SHOWN
14	REMOVE WINDOW, PREP OPENING FOR NEW OR RETROFITTED WINDOW
15	REMOVE GUTTERS AND DOWNSPOUTS
16	REMOVE PORTION OF ROOF FRAMING, SHEATHING, AND ASPHALT SHINGLES TO PREP FOR NEW ROOF FRAMING. SEE STRUCTURAL FOR EXTENTS OF EXISTING ROOF FRAMING TO BE REMOVED

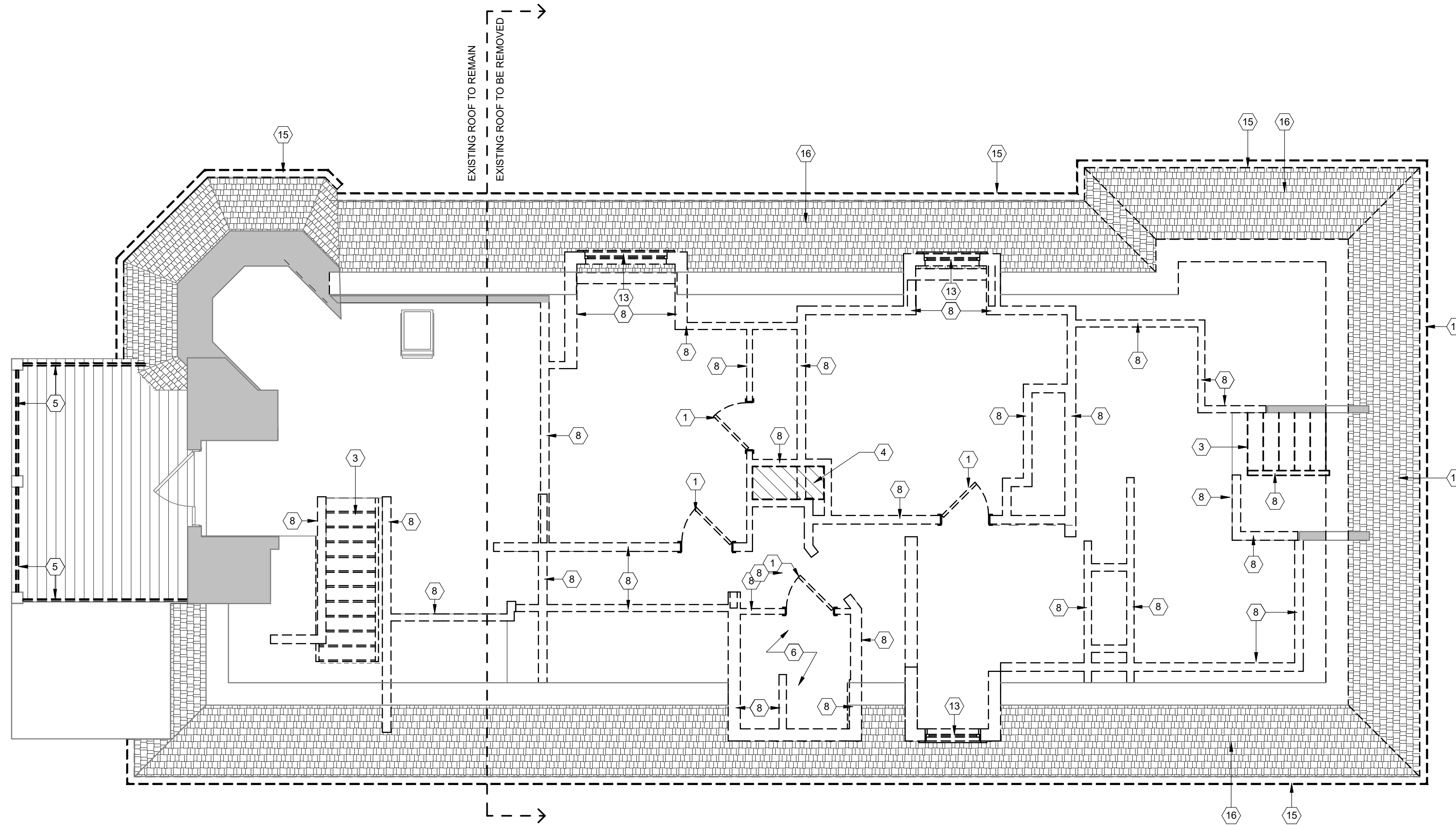

**1 THIRD FLOOR DEMOLITION PLAN**  
1/4" = 1'-0"

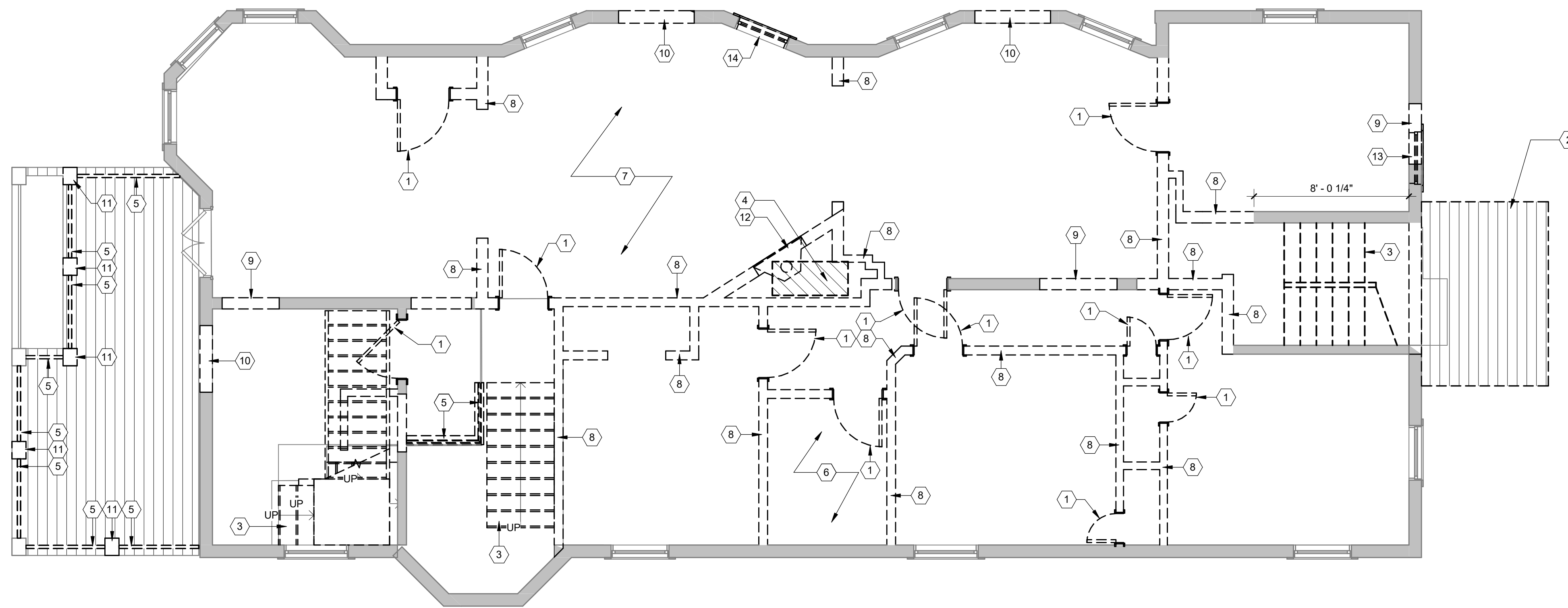

**2 SECOND FLOOR DEMOLITION PLAN**  
1/4" = 1'-0"

No.	Description	Date

**112 South Hancock Street**

Madison, WI 53703

**DEMOLITION PLANS**

CONSTRUCTION DOCUMENTS		
Project number	THA-22-01	
Date	06/08/2023	

**AD102**



KEYED NOTES (#)	
1	REMOVE GUTTERS AND DOWNSPOUTS
2	REMOVE GABLE ROOF AND DORMER WALLS AS SHOWN
3	REMOVE BRICK CHIMNEY AND ASSOCIATED DUCTWORK
4	REMOVE EXISTING PATIO FLOOR JOISTS, COLUMNS, RAILING, WOOD TRIM
5	REMOVE PORTION OF ROOF FRAMING, SHEATHING, AND ASPHALT SHINGLES TO PREP FOR NEW ROOF FRAMING. SEE STRUCTURAL FOR EXTENTS OF EXISTING ROOF FRAMING TO BE REMOVED
6	THIS PORTION OF EXISTING ROOF FRAMING TO REMAIN

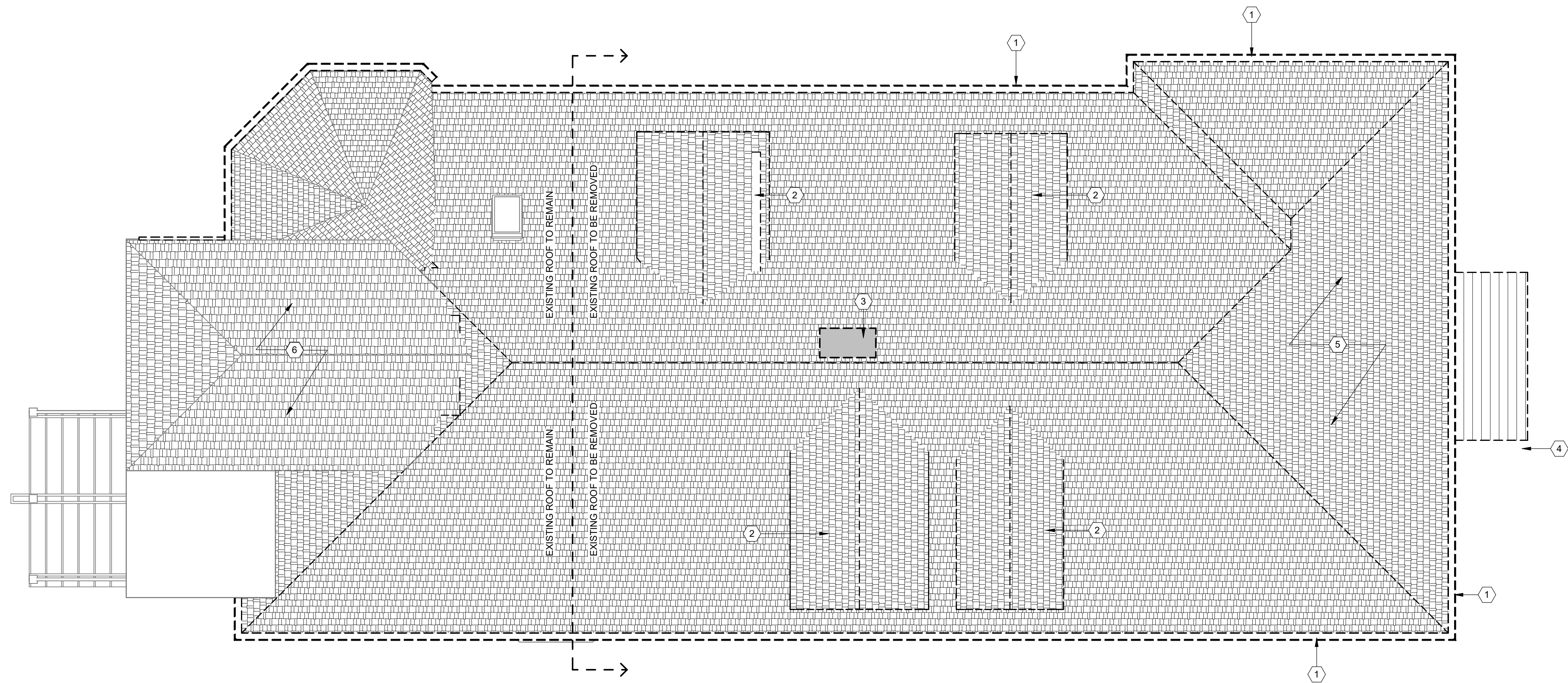

No.	Description	Date

NORTH  
**1** ROOF DEMOLITION PLAN  
1/4" = 1'-0"

112 South Hancock Street

Madison, WI 53703

**DEMOLITION PLANS**

CONSTRUCTION DOCUMENTS	
Project number	THA-22-01
Date	06/08/2023

**AD103**

**DEMOLITION GENERAL NOTES:**

1. SCOPE OF WORK INVOLVES THE REHABILITATION OF A HISTORIC BUILDING. TREAT THE BUILDING RESPECTFULLY. CAREFULLY RESPECT EXISTING CONDITIONS AND TREAT EXISTING MATERIALS AS IRREPLACEABLE. DO NOT REMOVE, ALTER, OR DISFIGURE ANY EXISTING MATERIALS, ELEMENTS, OR FINISHES UNLESS INDICATED IN THE DRAWINGS OR SPECIFICATIONS OR DIRECTED BY THE ARCHITECT.
2. FIELD VERIFY ALL DIMENSIONS, BRING ANY DISCREPANCIES TO THE ATTENTION OF THE ARCHITECT / ENGINEER FOR FINAL DECISION.
3. REPAIR ALL WALLS AND FINISHES DISTURBED DURING DEMOLITION THAT ARE TO REMAIN.
4. ALL EXISTING LIGHT FIXTURES ARE TO BE REMOVED.
5. PROVIDE SHORING OF EXISTING STRUCTURAL WALL AND ROOF MEMBERS PRIOR TO THE COMMENCEMENT OF ASSOCIATED DEMOLITION OPERATIONS.
6. PROVIDE FLOOR CUTTING/DEMOLITION AS NEEDED TO ROUTE EXISTING PLUMBING TO NEW PLUMBING FIXTURES. PATCH WOOD FLOORS AFTER WORK IS COMPLETE.
7. ALL EXISTING WALLS TO REMAIN ARE SHOWN SHADED GRAY.
8. CONTRACTORS ARE RESPONSIBLE FOR MAINTAINING CONTINUOUS UTILITY SERVICE TO ALL SPACES IN THE BUILDING NOT AFFECTED BY THIS WORK. ANY DISRUPTION IN SERVICE REQUIRED TO PERFORM WORK OR TO MODIFY EXISTING DUCTWORK, PIPING, CONDUIT, CIRCUITS OR ANY ASSOCIATED EQUIPMENT, MUST BE COORDINATED IN ADVANCE WITH THE OWNER/USER.
9. PROVIDE SLAB CUTTING/DEMOLITION AS NEEDED TO ROUTE PLUMBING TO NEW PLUMBING FIXTURES. PATCH CONCRETE FLOORS AFTER WORK IS COMPLETE.
10. ALL EXISTING WINDOWS TO REMAIN AS NOTED, WHERE POSSIBLE. CONTRACTOR TO PERFORM THOROUGH CONDITION ASSESSMENT FOR ALL WINDOWS TO DETERMINE LEVEL OF REPAIR, RESTORATION, OR REPLACEMENT NEEDED. NEW WINDOWS TO MATCH PROFILE OF EXISTING WINDOWS.
11. REMOVE ALL WINDOW AIR CONDITIONING UNITS.

**KEYED NOTES (#)**

1	REMOVE VINYL SIDING AND TRIM
2	REMOVE EXISTING PATIO FLOOR JOISTS, COLUMNS, RAILING, WOOD TRIM
3	REMOVE WINDOW AS SHOWN, REMOVE PORTION OF WALL AND PREP OPENING FOR NEW DOOR
4	REMOVE PORTION OF EXTERIOR WALL AS SHOWN, PREP FOR STAIR ADDITION
5	REMOVE PORTION OF ROOF FRAMING, SHEATHING, AND ASPHALT SHINGLES TO PREP FOR NEW ROOF FRAMING. SEE DEMO ROOF PLAN AND STRUCTURAL FOR EXTENTS OF EXISTING ROOF FRAMING TO BE REMOVED
6	REMOVE PORTION OF EXISTING FOUNDATION WALL AS SHOWN. PROVIDE NEW STEEL HEADER AT OPENING
7	REMOVE GUTTERS AND DOWNSPOUTS
8	REMOVE GABLE ROOF AND DORMER WALLS AS SHOWN
9	REMOVE WOOD RAILING AS SHOWN
10	REMOVE WOOD BALUSTER AS SHOWN
11	REMOVE PORTION OF EXTERIOR WALL TO CUT OPENING FOR NEW WINDOW



**1 NORTH ELEVATION - DEMOLITION**  
1/4" = 1'-0"

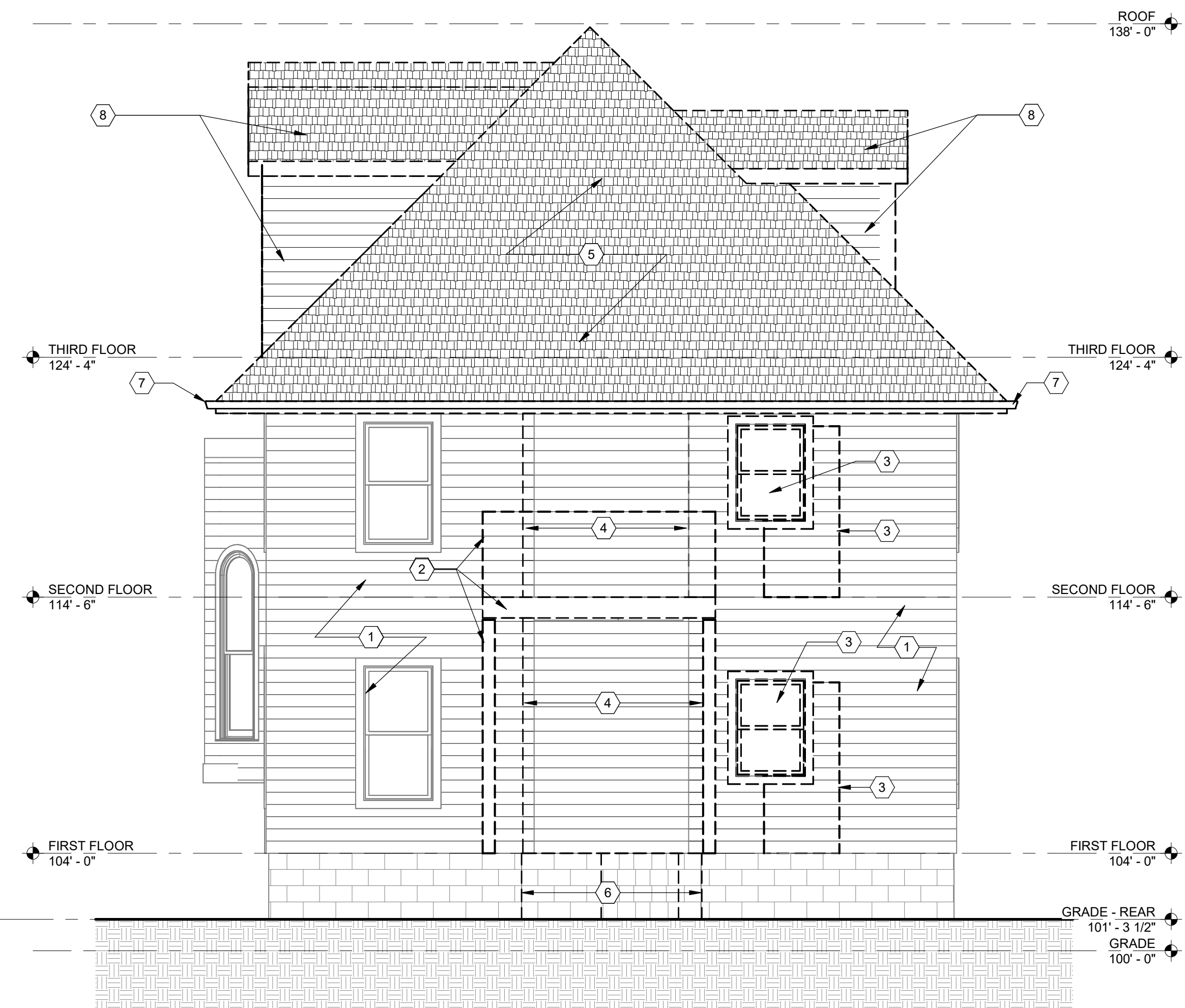

**2 SOUTH ELEVATION - DEMOLITION**  
1/4" = 1'-0"

No.	Description	Date

**112 South Hancock Street**

Madison, WI 53703

**DEMOLITION ELEVATIONS**

CONSTRUCTION DOCUMENTS	
Project number	THA-22-01
Date	06/08/2023

**AD201**

**DEMOLITION GENERAL NOTES:**

1. SCOPE OF WORK INVOLVES THE REHABILITATION OF A HISTORIC BUILDING. TREAT THE BUILDING RESPECTFULLY. CAREFULLY RESPECT EXISTING CONDITIONS AND TREAT EXISTING MATERIALS AS IRREPLACEABLE. DO NOT REMOVE, ALTER, OR DISFIGURE ANY EXISTING MATERIALS, ELEMENTS, OR FINISHES UNLESS INDICATED IN THE DRAWINGS OR SPECIFICATIONS OR DIRECTED BY THE ARCHITECT.
2. FIELD VERIFY ALL DIMENSIONS. BRING ANY DISCREPANCIES TO THE ATTENTION OF THE ARCHITECT / ENGINEER FOR FINAL DECISION.
3. REPAIR ALL WALLS AND FINISHES DISTURBED DURING DEMOLITION THAT ARE TO REMAIN.
4. ALL EXISTING LIGHT FIXTURES ARE TO BE REMOVED.
5. PROVIDE SHORING OF EXISTING STRUCTURAL WALL AND ROOF MEMBERS PRIOR TO THE COMMENCEMENT OF ASSOCIATED DEMOLITION OPERATIONS.
6. PROVIDE FLOOR CUTTING/DEMOLITION AS NEEDED TO ROUTE EXISTING PLUMBING TO NEW PLUMBING FIXTURES. PATCH WOOD FLOORS AFTER WORK IS COMPLETE.
7. ALL EXISTING WALLS TO REMAIN ARE SHOWN SHADED GRAY.
8. CONTRACTORS ARE RESPONSIBLE FOR MAINTAINING CONTINUOUS UTILITY SERVICE TO ALL SPACES IN THE BUILDING NOT AFFECTED BY THIS WORK. ANY DISRUPTION IN SERVICE REQUIRED TO PERFORM WORK OR TO MODIFY EXISTING DUCTWORK, PIPING, CONDUIT, CIRCUITS OR ANY ASSOCIATED EQUIPMENT, MUST BE COORDINATED IN ADVANCE WITH THE OWNER/USER.
9. PROVIDE SLAB CUTTING/DEMOLITION AS NEEDED TO ROUTE PLUMBING TO NEW PLUMBING FIXTURES. PATCH CONCRETE FLOORS AFTER WORK IS COMPLETE.
10. ALL EXISTING WINDOWS TO REMAIN AS NOTED, WHERE POSSIBLE. CONTRACTOR TO PERFORM THOROUGH CONDITION ASSESSMENT FOR ALL WINDOWS TO DETERMINE LEVEL OF REPAIR, RESTORATION, OR REPLACEMENT NEEDED. NEW WINDOWS TO MATCH PROFILE OF EXISTING WINDOWS.
11. REMOVE ALL WINDOW AIR CONDITIONING UNITS.

**KEYED NOTES (#)**

1	REMOVE VINYL SIDING AND TRIM
2	REMOVE WOOD RAILING AS SHOWN
3	REMOVE WOOD BALUSTER AS SHOWN
4	REMOVE EXISTING PATIO FLOOR, JOISTS, COLUMNS, RAILING, WOOD TRIM
5	REMOVE GABLE ROOF AND DORMER WALLS AS SHOWN
6	REMOVE WINDOW AS SHOWN
7	REMOVE GUTTERS AND DOWNSPOUTS
8	REMOVE PORTION OF ROOF FRAMING, SHEATHING, AND ASPHALT SHINGLES TO PREP FOR NEW ROOF FRAMING. SEE DEMO ROOF PLAN AND STRUCTURAL FOR EXTENTS OF EXISTING ROOF FRAMING TO BE REMOVED
9	REMOVE WINDOW, PREP OPENING FOR NEW OR RETROFITTED WINDOW
10	REMOVE PORTION OF EXTERIOR WALL TO CUT OPENING FOR NEW WINDOW



**1 EAST ELEVATION - DEMOLITION**  
3/16" = 1'-0"

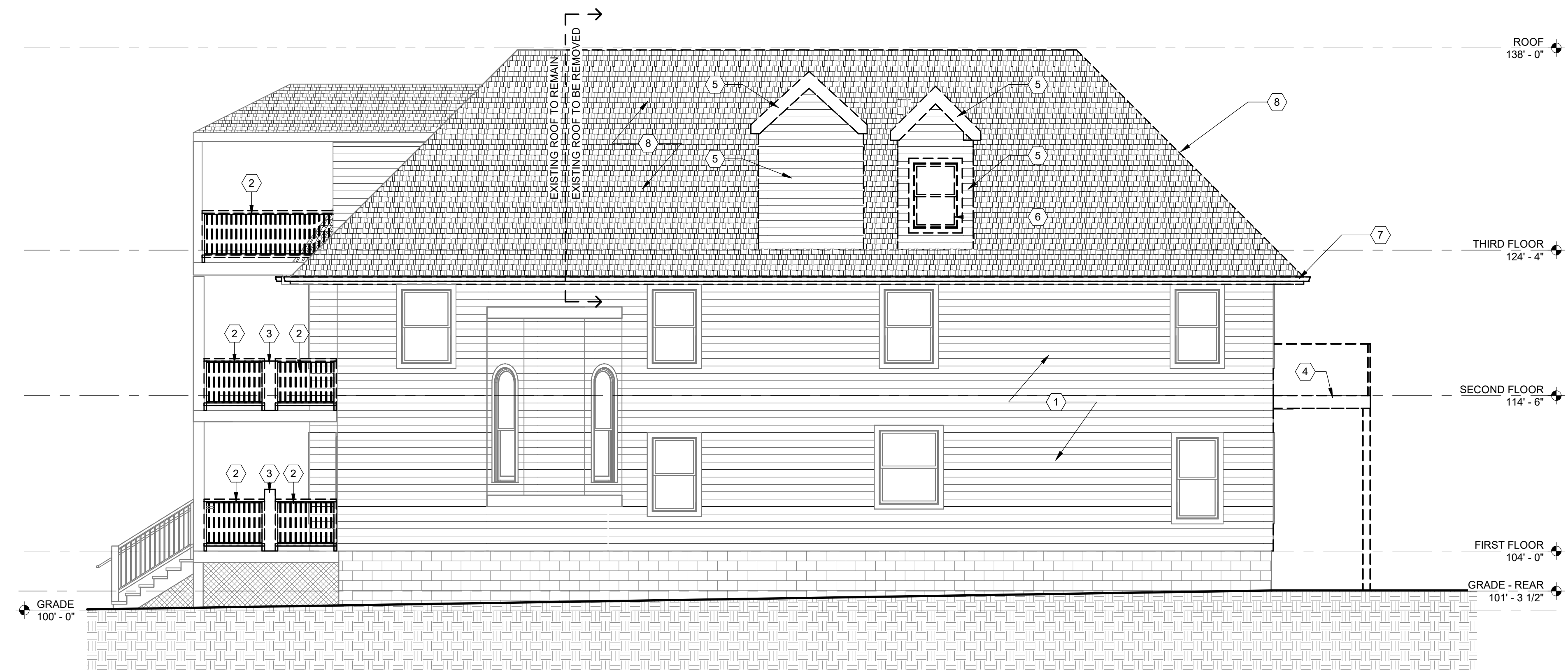

**2 WEST ELEVATION - DEMOLITION**  
3/16" = 1'-0"

No.	Description	Date

112 South Hancock Street

Madison, WI 53703

**DEMOLITION ELEVATIONS**

CONSTRUCTION DOCUMENTS	
Project number	THA-22-01
Date	06/08/2023

AD202

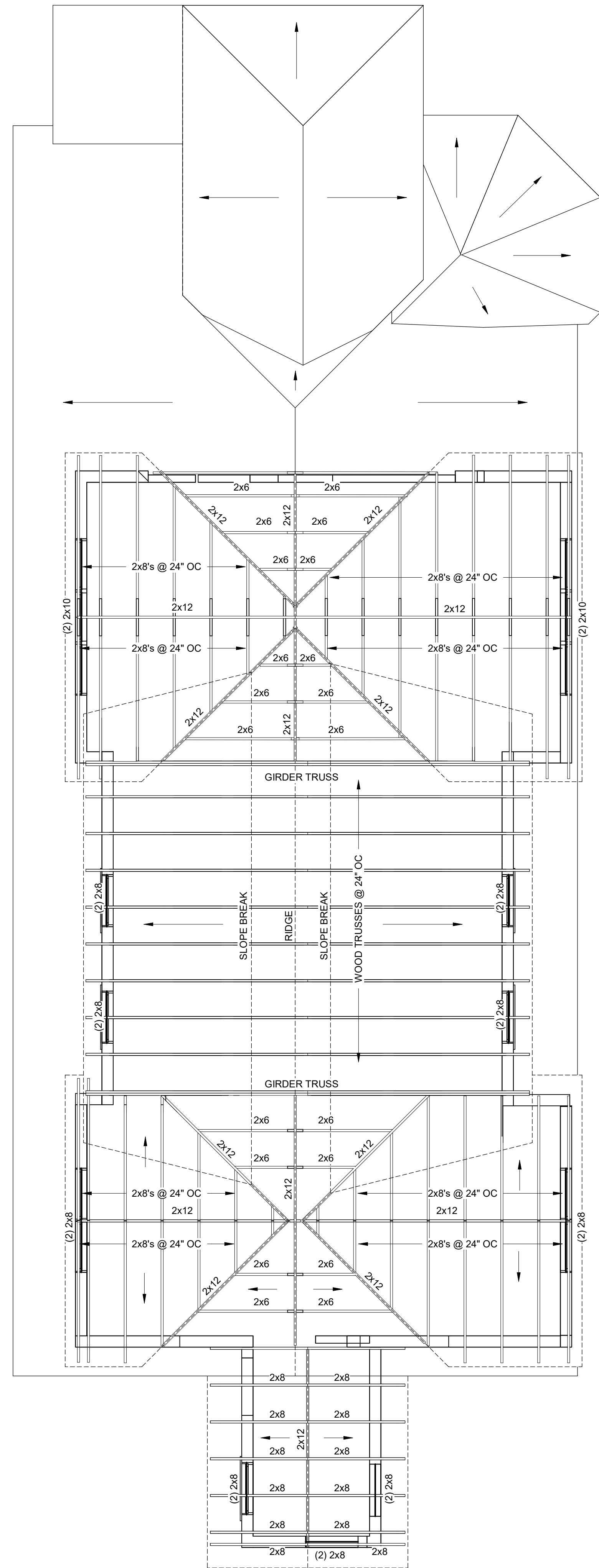

**FRAMING NOTES**

- ALL DIMENSIONAL STRUCTURAL FRAMING MEMBERS SHALL BE S-P-F, No 2 OR BETTER LUMBER.
- ROOF SHEATHING SHALL BE 1/2" APA EXPOSURE RATED SHEATHING WITH A 24/0 SPAN RATING. ATTACH TO ROOF TRUSSES WITH 8d RING SHANK NAILS @ 6" OC AT PANEL EDGES AND 12" OC AT INTERMEDIATE SUPPORTS.
- STAGGER SHEATHING JOINTS 4 FEET BETWEEN SHEATHING COURSES.
- LVL FRAMING SHALL HAVE THE FOLLOWING MINIMUM DESIGN PROPERTIES:  

ALLOWABLE BENDING STRESS:	2,900 PSI
ALLOWABLE SHEAR STRESS:	285 PSI
MODULUS OF ELASTICITY:	2.0 x 10 <sup>6</sup> PSI
- PRE-ENGINEERED ROOF TRUSSES SHALL BE DESIGNED FOR THE FOLLOWING LOADS:  

TC DL:	10 PSF
BC DL:	10 PSF
TC LL:	20 PSF
TC SL:	22 PSF

No.	Description	Date

Owner

Project Name

Enter address here

**ROOF FRAMING PLAN**

Project Status	
Project number	Project Number
Date	Issue Date

**S200**

KEYED NOTES #	
1	1-HOUR FIRE RESISTANCE RATING REQUIRED BETWEEN UNITS; REMOVE EXISTING PLASTER AND WOOD LATH TO EXPOSE STUDS AND RECONSTRUCT PARTITION TO MATCH PARTITION TYPE P12.
2	EXISTING POCKET DOOR AND TRIM TO REMAIN
3	ELECTRIC WALL HEATER (1KW) WITH INTERNAL THERMOSTAT
4	ELECTRICAL PANELS
5	WATER METER
6	SANITARY STACK
7	EXISTING HOT WATER HEATER
8	WATER SOFTENER

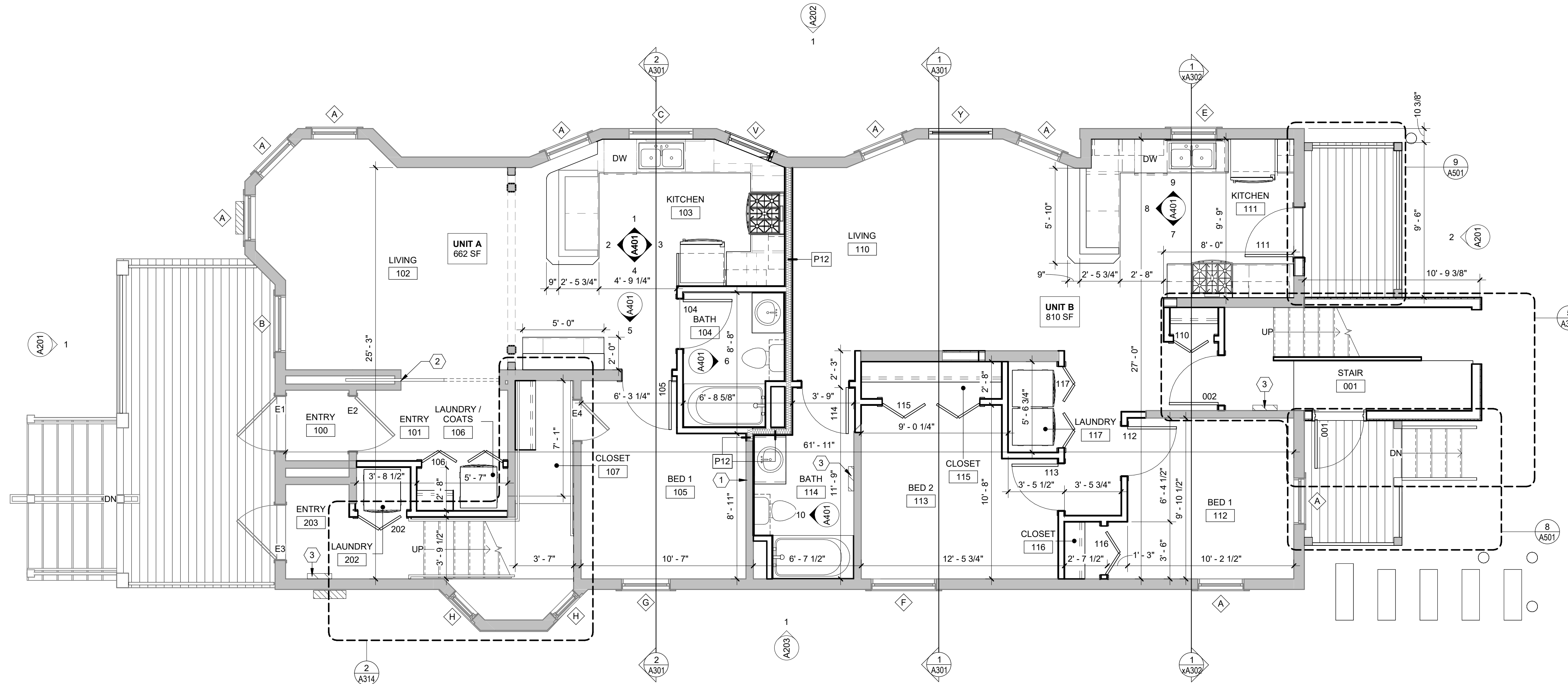

NORTH  
**1** FIRST FLOOR PLAN  
1/4" = 1'-0"

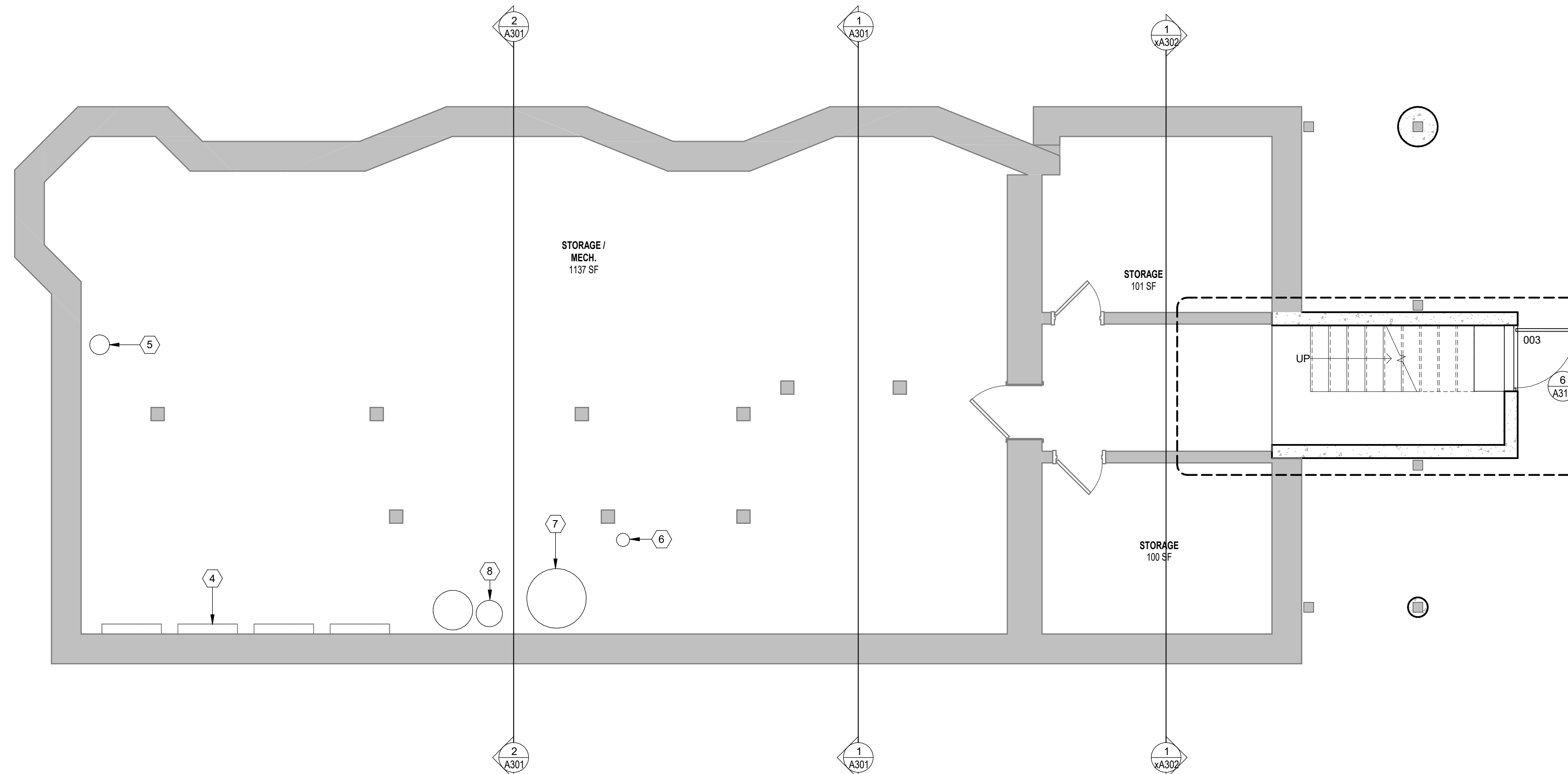

NORTH  
**2** BASEMENT PLAN  
1/4" = 1'-0"

**FLOOR PLAN GENERAL NOTES:**

1. SITE DATUM OF 891' = GRADE AT 100'-0". FIRST FLOOR ELEVATION IS 104' - 0" ON ARCHITECTURAL DRAWINGS.
2. FIELD VERIFY ALL DIMENSIONS. BRING ANY DISCREPANCIES TO THE ATTENTION OF THE ARCHITECT / ENGINEER FOR FINAL DECISION.
3. SEE SHEET A001 FOR PARTITION TYPES & MEP SCOPE OF WORK.
4. SEE SHEET A002 FOR DOOR SCHEDULE AND WINDOW SCHEDULE.
5. SEE SHEET A111, A112, A113 FOR REFLECTED CEILING PLANS.
6. SEE SHEET A121, A122 FOR FINISH PLAN AND SCHEDULES.
7. DIMENSIONS ON FLOOR PLAN ARE BASED ON FACE OF FINISH WALL TO FINISHED WALL (NOMINAL).
8. REFER TO DEMOLITION SHEETS FOR COORDINATION OF DEMOLITION SCOPE.

No.	Description	Date

**112 South Hancock Street**

Madison, WI 53703

**BASEMENT & FIRST FLOOR PLAN**

CONSTRUCTION DOCUMENTS	
Project number	THA-22-01
Date	06/08/2023

**A101**

**FLOOR PLAN GENERAL NOTES:**

1. SITE DATUM OF 891' = GRADE AT 100'-0". FIRST FLOOR ELEVATION IS 104'-0" ON ARCHITECTURAL DRAWINGS.
2. FIELD VERIFY ALL DIMENSIONS. BRING ANY DISCREPANCIES TO THE ATTENTION OF THE ARCHITECT / ENGINEER FOR FINAL DECISION.
3. SEE SHEET A001 FOR PARTITION TYPES & MEP SCOPE OF WORK.
4. SEE SHEET A002 FOR DOOR SCHEDULE AND WINDOW SCHEDULE.
5. SEE SHEET A111, A112, A113 FOR REFLECTED CEILING PLANS.
6. SEE SHEET A121, A122 FOR FINISH PLAN AND SCHEDULES.
7. DIMENSIONS ON FLOOR PLAN ARE BASED ON FACE OF FINISH WALL TO FINISHED WALL (NOMINAL).
8. REFER TO DEMOLITION SHEETS FOR COORDINATION OF DEMOLITION SCOPE.

**KEYED NOTES**

1	INFILL FLOOR AT CHIMNEY
2	EXISTING SKYLIGHT TO REMAIN
3	INFILL FLOOR AT STAIR
4	ELECTRIC WALL HEATER (1KW) WITH INTERNAL THERMOSTAT
5	SHELF
6	HATCH INDICATES NEW FLOOR AREA

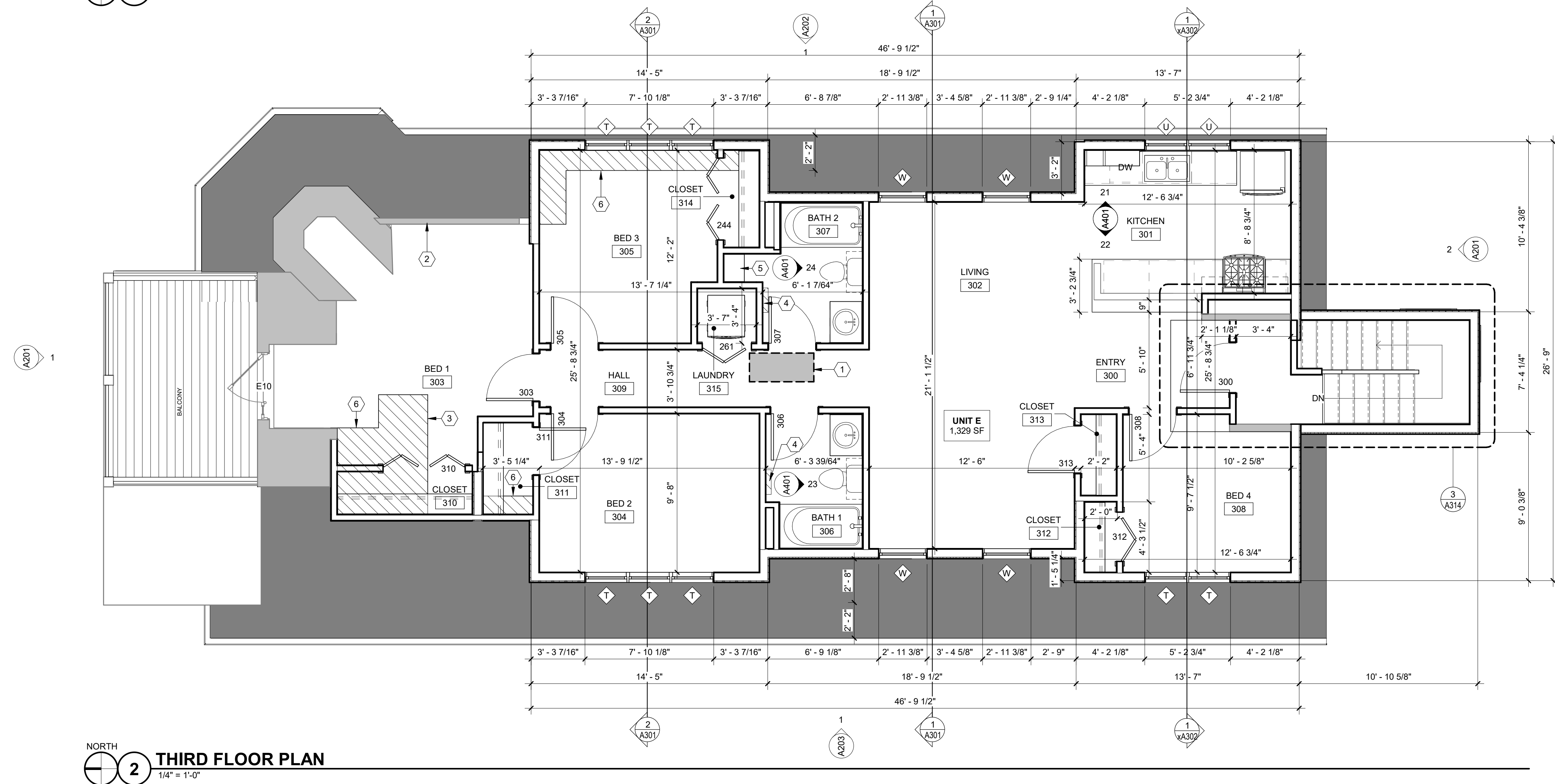
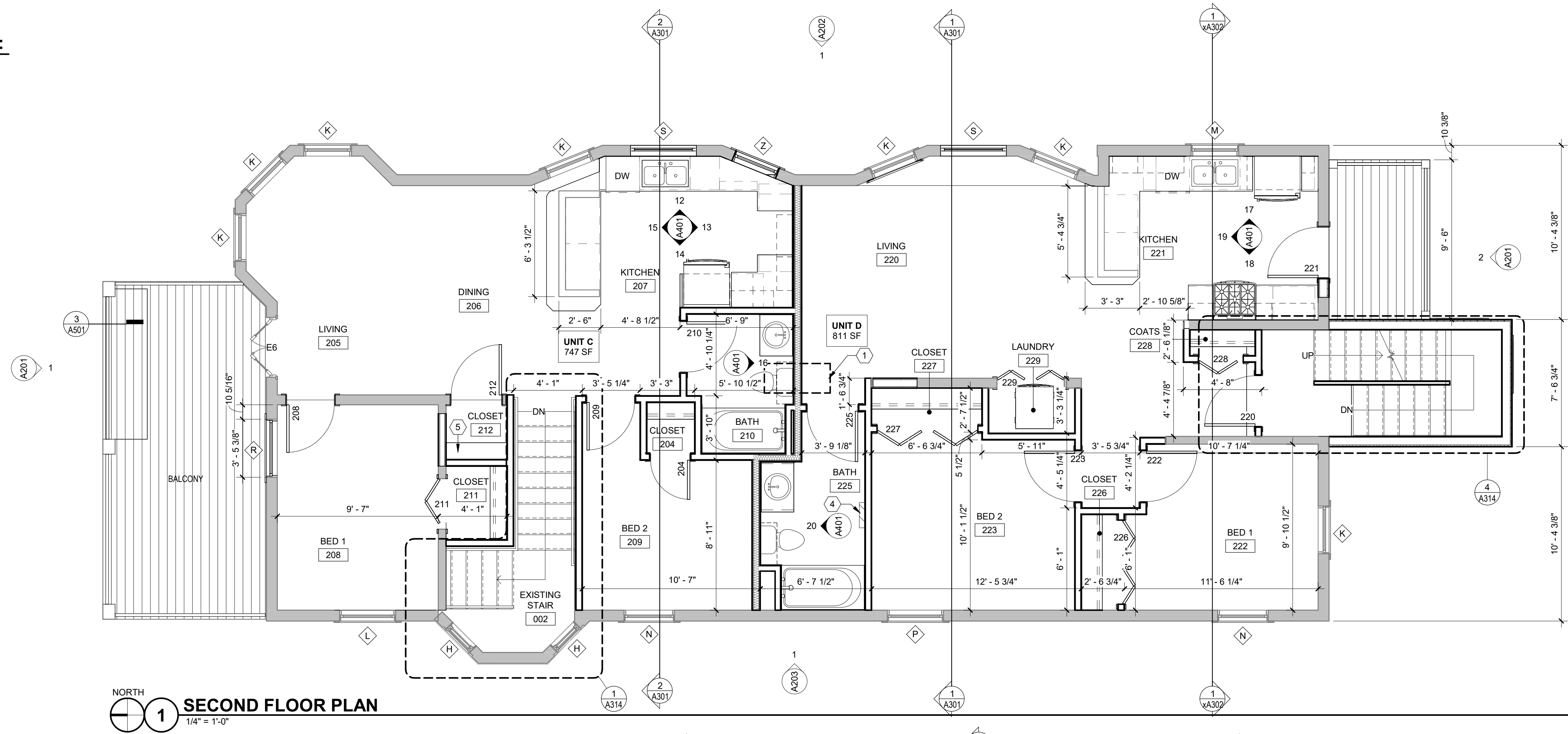

No.	Description	Date

112 South Hancock Street

Madison, WI 53703

**SECOND & THIRD FLOOR PLAN**

CONSTRUCTION DOCUMENTS

Project number	THA-22-01
Date	06/08/2023

**A102**

**FLOOR PLAN GENERAL NOTES:**

1. SITE DATUM OF 89'1" = GRADE AT 100'-0". FIRST FLOOR ELEVATION IS 104'-0" ON ARCHITECTURAL DRAWINGS.
2. FIELD VERIFY ALL DIMENSIONS. BRING ANY DISCREPANCIES TO THE ATTENTION OF THE ARCHITECT / ENGINEER FOR FINAL DECISION.
3. SEE SHEET A001 FOR PARTITION TYPES & MEP SCOPE OF WORK.
4. SEE SHEET A002 FOR DOOR SCHEDULE AND WINDOW SCHEDULE.
5. SEE SHEET A111, A112, A113 FOR REFLECTED CEILING PLANS.
6. SEE SHEET A121, A122 FOR FINISH PLAN AND SCHEDULES.
7. DIMENSIONS ON FLOOR PLAN ARE BASED ON FACE OF FINISH WALL TO FINISHED WALL (NOMINAL).
8. REFER TO DEMOLITION SHEETS FOR COORDINATION OF DEMOLITION SCOPE.

**KEYED NOTES** (#)

1	NEW ALUMINUM GUTTER
2	NEW ALUMINUM DOWNSPOUT, DRAIN TO GRADE
3	NEW ASPHALT SHINGLES
4	EXISTING SKYLIGHT TO REMAIN
5	EPDM ROOF, SLOPE 1/4" PER FOOT

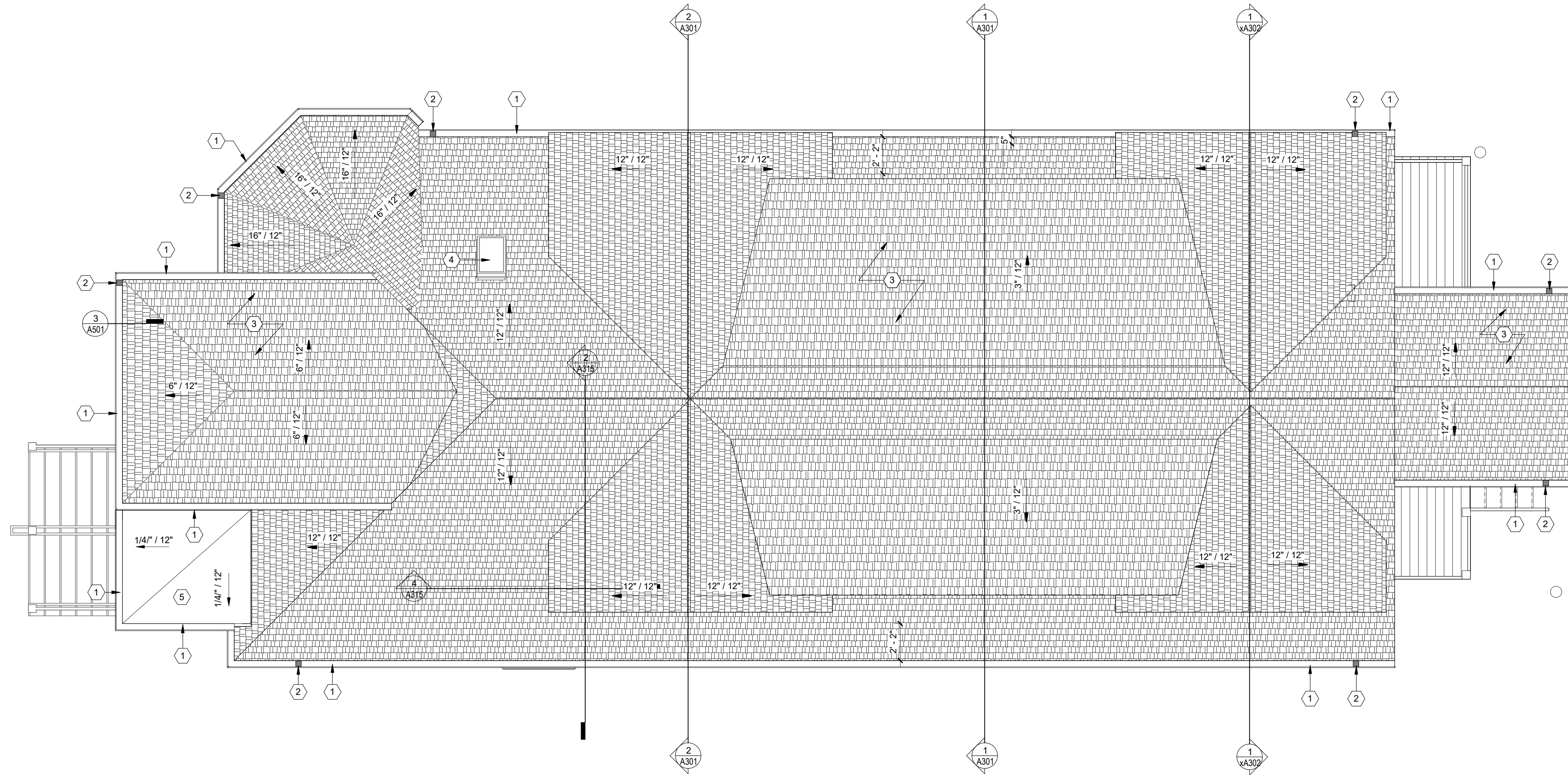

No.	Description	Date

NORTH  
**1** ROOF PLAN  
1/4" = 1'-0"

112 South Hancock Street

Madison, WI 53703

**ROOF PLAN**

CONSTRUCTION DOCUMENTS	
Project number	THA-22-01
Date	06/08/2023

**A104**

LIGHT FIXTURE SCHEDULE								
MARK	FIXTURE TYPE	MANUFACTURER	MODEL NUMBER	LAMP TYPE	COLOR TEMP.	COLOR	DIMMIN G	REMARKS
F1	4" RECESSED DOWNLIGHT OR SURFACE MOUNTED FIXTURE			LED	3000		YES	1
F2	VANITY LIGHT FIXTURE			LED	3000		NO	
F3	PENDANT			LED	3000		YES	
F4	CEILING FAN W/ LIGHT			LED	3000		YES	
F5	UNDER CABINET MOUNTED LINEAR STRIP LIGHT			LED	2700		NO	
F6	LINEAR SURFACE MOUNTED LIGHT			LED	2700		NO	
F7	EXTERIOR WALL MOUNTED DOWNLIGHT			LED	2700		NO	
F8	WALL MOUNTED SCONCE			LED	3000		NO	
F9	SURFACE MOUNTED LIGHT			LED	3000		YES	

LIGHT FIXTURE SCHEDULE REMARKS	
1.	RECESSED FIXTURES MUST MEET 1 HR FIRE RATING

**CEILING GENERAL NOTES:**

- REFER TO FINISH SCHEDULE FOR KEY CODES, SELECTION AND COLOR.
- ALL CEILINGS OR SOFFITS NOTED AS GWB OR PLASTER TO BE PAINTED PT-XX UNLESS NOTED OTHERWISE.

**CEILING LEGEND:**

- GYPSUM BOARD CEILING (PAINTED)
- 12" x 48" RECESSED LIGHT FIXTURE
- 6" x 48" RECESSED LIGHT FIXTURE
- RECESSED DOWN LIGHT
- SUPPLY AIR DIFFUSER
- RETURN AIR DIFFUSER / EXHAUST GRILL
- EXHAUST FAN
- SUPPLY AIR DIFFUSER - SLOT
- 1' x 4' LIGHT FIXTURE (SUSPENDED)
- INDUSTRIAL FLUORESCENT
- WALL MOUNTED EXIT LIGHT
- CEILING MOUNTED EXIT LIGHT
- SPRINKLER
- SMOKE ALARM
- OCCUPANCY SENSOR
- SMOKE DETECTOR
- CONTROL JOINT
- CEILING HEIGHT / MATERIAL
- CEILING FAN W/ LIGHT
- PENDANT LIGHT



433 W. Washington Ave. (608) 204-7464  
Suite 400 AroEberle.com  
Madison, WI 53703

KEYED NOTES (#)	
1	CROWN MOLDING
2	WALL MOUNTED FAN COIL WITH HAND REMOTE
3	80 CFM BATH EXHAUST FAN (NO LIGHT)
4	GWB SOFFIT

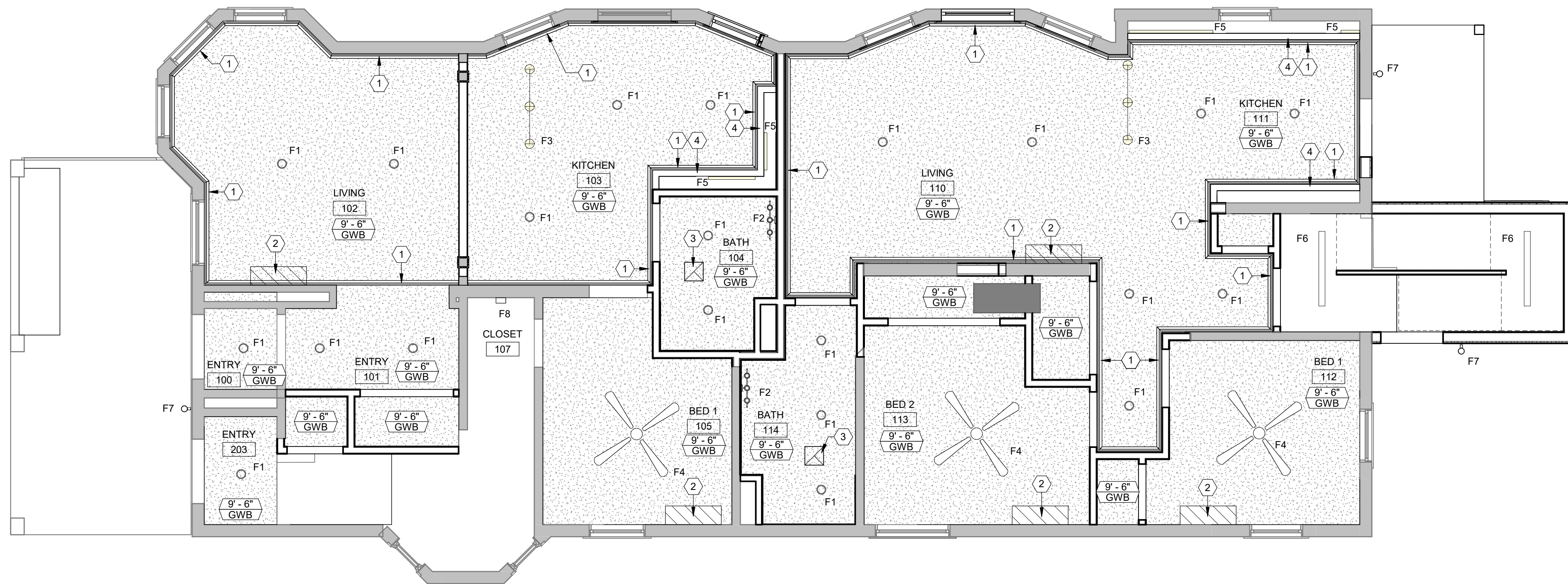

No.	Description	Date

112 South Hancock Street

Madison, WI 53703

**FIRST FLOOR REFLECTED CEILING PLAN**

CONSTRUCTION DOCUMENTS	
Project number	THA-22-01
Date	06/08/2023

A111

**FIRST FLOOR REFLECTED CEILING PLAN**  
1/4" = 1'-0"



LIGHT FIXTURE SCHEDULE								
MARK	FIXTURE TYPE	MANUFACTURER	MODEL NUMBER	LAMP TYPE	COLOR TEMP.	COLOR	DIMMIN G	REMARKS
F1	4" RECESSED DOWNLIGHT OR SURFACE MOUNTED FIXTURE			LED	3000		YES	1
F2	VANITY LIGHT FIXTURE			LED	3000		NO	
F3	PENDANT			LED	3000		YES	
F4	CEILING FAN W/ LIGHT			LED	3000		YES	
F5	UNDER CABINET MOUNTED LINEAR STRIP LIGHT			LED	2700		NO	
F6	LINEAR SURFACE MOUNTED LIGHT			LED	2700		NO	
F7	EXTERIOR WALL MOUNTED DOWNLIGHT			LED	2700		NO	
F8	WALL MOUNTED SCONCE			LED	3000		NO	
F9	SURFACE MOUNTED LIGHT			LED	3000		YES	
LIGHT FIXTURE SCHEDULE REMARKS								
1.	RECESSED FIXTURES MUST MEET 1 HR FIRE RATING							

**CEILING GENERAL NOTES:**

- REFER TO FINISH SCHEDULE FOR KEY CODES, SELECTION AND COLOR.
- ALL CEILINGS OR SOFFITS NOTED AS GWB OR PLASTER TO BE PAINTED PT-XX UNLESS NOTED OTHERWISE.

**CEILING LEGEND:**

- GYPSUM BOARD CEILING (PAINTED)
- 12" x 48" RECESSED LIGHT FIXTURE
- 6" x 48" RECESSED LIGHT FIXTURE
- RECESSED DOWN LIGHT
- SUPPLY AIR DIFFUSER
- RETURN AIR DIFFUSER / EXHAUST GRILL
- EXHAUST FAN
- SUPPLY AIR DIFFUSER - SLOT
- 1" x 4" LIGHT FIXTURE (SUSPENDED)
- INDUSTRIAL FLUORESCENT
- WALL MOUNTED EXIT LIGHT
- CEILING MOUNTED EXIT LIGHT
- SPRINKLER
- SMOKE ALARM
- OCCUPANCY SENSOR
- SMOKE DETECTOR
- CONTROL JOINT
- CEILING HEIGHT / MATERIAL
- CEILING FAN W/ LIGHT
- PENDANT LIGHT



433 W. Washington Ave. (608) 204-7464  
Suite 400 AroEberle.com  
Madison, WI 53703

KEYED NOTES (#)	
1	GWB SOFFIT
2	WALL MOUNTED FAN COIL WITH HAND REMOTE
3	80 CFM BATH EXHAUST FAN (NO LIGHT)
4	CROWN MOLDING

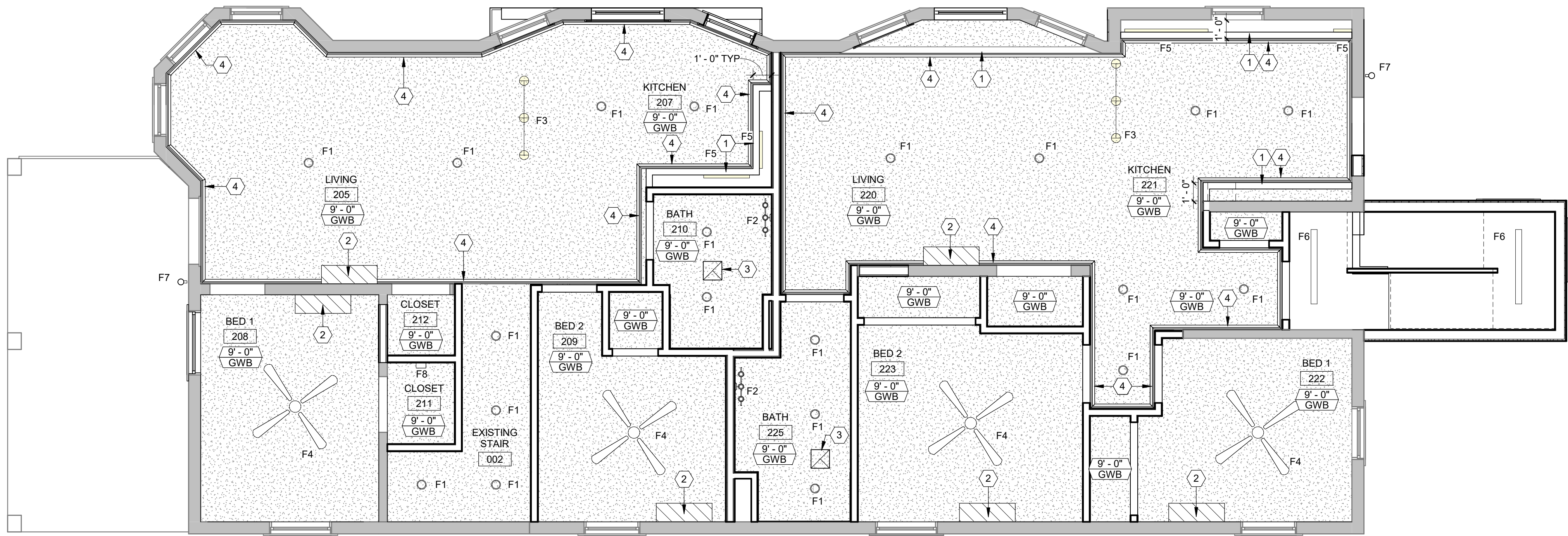

No.	Description	Date

112 South Hancock Street  
Madison, WI 53703  
**SECOND FLOOR REFLECTED CEILING PLAN**

**SECOND FLOOR REFLECTED CEILING PLAN**  
1/4" = 1'-0"

CONSTRUCTION DOCUMENTS  
Project number: THA-22-01  
Date: 06/08/2023

**A112**

LIGHT FIXTURE SCHEDULE								
MARK	FIXTURE TYPE	MANUFACTURER	MODEL NUMBER	LAMP TYPE	COLOR TEMP.	COLOR	DIMMIN G	REMARKS
F1	4" RECESSED DOWNLIGHT OR SURFACE MOUNTED FIXTURE			LED	3000		YES	1
F2	VANITY LIGHT FIXTURE			LED	3000		NO	
F3	PENDANT			LED	3000		YES	
F4	CEILING FAN W/ LIGHT			LED	3000		YES	
F5	UNDER CABINET MOUNTED LINEAR STRIP LIGHT			LED	2700		NO	
F6	LINEAR SURFACE MOUNTED LIGHT			LED	2700		NO	
F7	EXTERIOR WALL MOUNTED DOWNLIGHT			LED	2700		NO	
F8	WALL MOUNTED SCONCE			LED	3000		NO	
F9	SURFACE MOUNTED LIGHT			LED	3000		YES	

LIGHT FIXTURE SCHEDULE REMARKS	
1.	RECESSED FIXTURES MUST MEET 1 HR FIRE RATING

**CEILING GENERAL NOTES:**

- REFER TO FINISH SCHEDULE FOR KEY CODES, SELECTION AND COLOR.
- ALL CEILINGS OR SOFFITS NOTED AS GWB OR PLASTER TO BE PAINTED PT-XX UNLESS NOTED OTHERWISE.

**CEILING LEGEND:**

- GYPSUM BOARD CEILING (PAINTED)
- 12" x 48" RECESSED LIGHT FIXTURE
- 6" x 48" RECESSED LIGHT FIXTURE
- RECESSED DOWN LIGHT
- SUPPLY AIR DIFFUSER
- RETURN AIR DIFFUSER / EXHAUST GRILL
- EXHAUST FAN
- SUPPLY AIR DIFFUSER - SLOT
- 1' x 4' LIGHT FIXTURE (SUSPENDED)
- INDUSTRIAL FLUORESCENT
- WALL MOUNTED EXIT LIGHT
- CEILING MOUNTED EXIT LIGHT
- SPRINKLER
- SMOKE ALARM
- OCCUPANCY SENSOR
- SMOKE DETECTOR
- CONTROL JOINT
- CEILING HEIGHT / MATERIAL
- CEILING FAN W/ LIGHT
- PENDANT LIGHT

KEYED NOTES (#)	
1	WALL MOUNTED FAN COIL WITH HAND REMOTE
2	80 CFM BATH EXHAUST FAN (NO LIGHT)

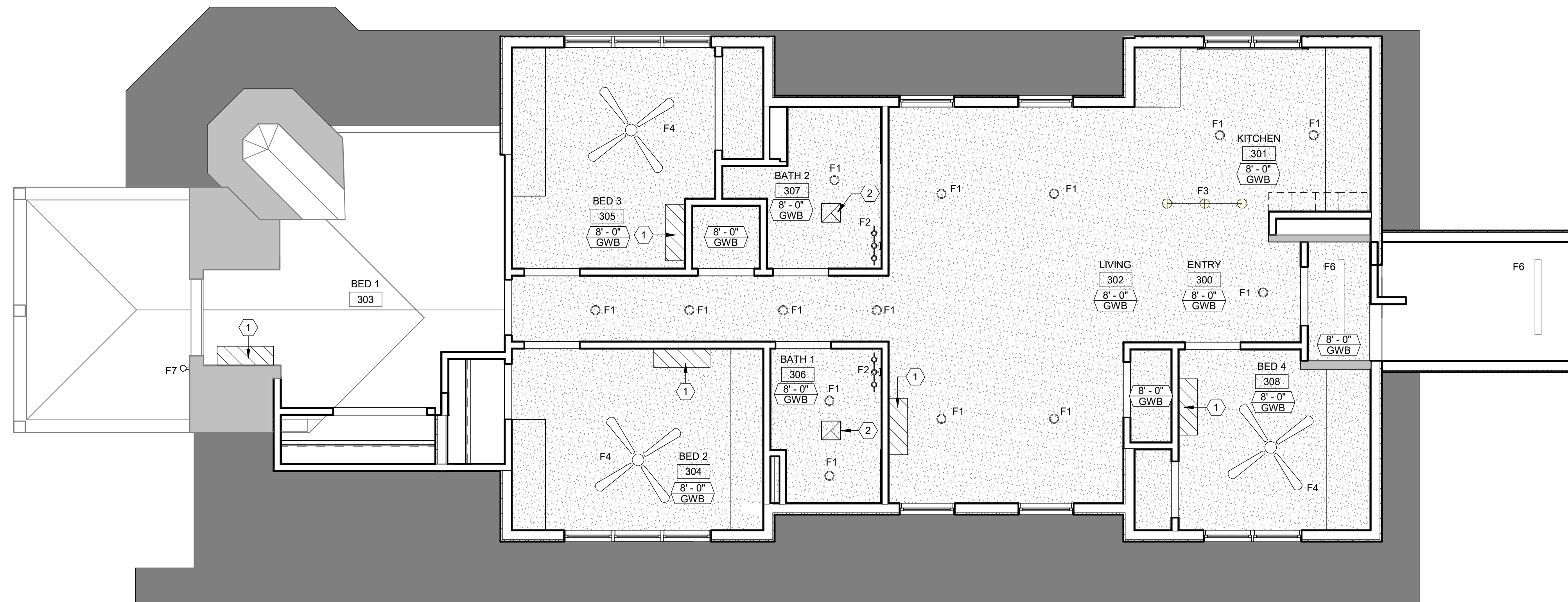

No.	Description	Date

112 South Hancock Street

Madison, WI 53703

**THIRD FLOOR REFLECTED CEILING PLAN**

CONSTRUCTION DOCUMENTS	
Project number	THA-22-01
Date	06/08/2023

**A113**

NORTH **1** THIRD FLOOR REFLECTED CEILING PLAN  
1/4" = 1'-0"

KEYED NOTES	
1	DECORATIVE WAINSCOTTING 42" HIGH

FINISH NUMBER	FINISH DESCRIPTION	MANUFACTURER	MODEL NUMBER	PRODUCT DESCRIPTION			REMARKS
				STYLE	COLOR	SIZE	
CM-1	CROWN MOLDING - TYPE 1	WOODGRAIN MILLWORK	WM 49 / WM 51	-	-	9/16" x 3-5/8" x 192"	PAINT PT-1
CT-1	CERAMIC TILE - TYPE 1	DALTILE	-	COLOR WHEEL CLASSIC	ARCTIC WHITE 0190 (1)	3" x 6"	KITCHEN BACKSPASHES & BATHROOM WET WALLS
CT-2	CERAMIC TILE - TYPE 2	CERAMIC TILEWORKS	-	BUILDER BASIC 1" HEX MOSAIC	WHITE AND BLACK	SHEET = 10.5" x 11.75"	BATHROOM FLOORS
CTB-1	CERAMIC TILE BASE - TYPE 1	DALTILE	S3419T	COLOR WHEEL CLASSIC	ARCTIC WHITE 0190 (1)	4-1/4" x 6"	BATHROOM COVE BASE, USE COORDINATING CORNER TRIM
GR-1	GROUT COLOR - TYPE 1	MAPEI	10	-	BLACK	-	USE WITH CT-1 AND CT-2
GT-1	GRANITE - TYPE 1	-	-	-	-	-	OWNER SELECTION
PT-1	PAINT COLOR - TYPE 1	SHERWIN WILLIAMS	SW 7636	SEMI GLOSS	ORIGAMI WHITE	-	GENERAL WALL PAINT COLOR
PT-2	PAINT COLOR - TYPE 2	SHERWIN WILLIAMS	SW 7008	FLAT	ALABASTER	-	CEILING PAINT COLOR
PT-3	PAINT COLOR - TYPE 3	SHERWIN WILLIAMS	-	SEMI GLOSS	-	-	ACCENT PAINT COLOR
PT-4	PAINT COLOR - TYPE 4	SHERWIN WILLIAMS	SW 7605	HIGH GLOSS	GALE FORCE	-	NAVY CABINET COLOR
PT-5	PAINT COLOR - TYPE 5	SHERWIN WILLIAMS	SW 7659	HIGH GLOSS	GRIS	-	GRAY CABINET COLOR
PT-6	PAINT COLOR - TYPE 6	SHERWIN WILLIAMS	-	-	-	-	HOLLOW METAL DOOR PAINT COLOR
STN-1	WOOD STAIN - TYPE 1	-	-	-	-	-	MATCH EXISTING WOOD FINISH
WB-1	WOOD BASE - TYPE 1	-	-	-	-	-	REPAIR & REFINISH EXISTING HARDWOOD BASE, NEW AS NEEDED
WF-1	WOOD FLOORING - TYPE 1	-	-	-	-	-	REPAIR & REFINISH EXISTING HARDWOOD FLOORING

UNIT #	ROOM NO.	ROOM NAME	FLOOR	BASE	WALLS				CEILING		REMARKS
					NORTH	SOUTH	EAST	WEST	MTL	HEIGHT	
	212	CLOSET									
STAIR	001	STAIR								GWB	SEE RCP
STAIR	002	EXISTING STAIR								GWB	SEE RCP
UNIT A	100	ENTRY								GWB	SEE RCP
UNIT A	101	ENTRY								GWB	SEE RCP
UNIT A	102	LIVING								GWB	SEE RCP
UNIT A	103	KITCHEN								GWB	SEE RCP
UNIT A	104	BATH								GWB	SEE RCP
UNIT A	105	BED 1								GWB	SEE RCP
UNIT A	106	LAUNDRY / COATS								GWB	SEE RCP
UNIT A	107	CLOSET								GWB	SEE RCP
UNIT B	110	LIVING								GWB	SEE RCP
UNIT B	111	KITCHEN								GWB	SEE RCP
UNIT B	112	BED 1								GWB	SEE RCP
UNIT B	113	BED 2								GWB	SEE RCP
UNIT B	114	BATH								GWB	SEE RCP
UNIT B	115	CLOSET								GWB	SEE RCP
UNIT B	116	CLOSET								GWB	SEE RCP
UNIT B	117	LAUNDRY								GWB	SEE RCP
UNIT B	118	ENTRY								GWB	SEE RCP
UNIT C	202	LAUNDRY								GWB	SEE RCP
UNIT C	203	ENTRY								GWB	SEE RCP
UNIT C	204	CLOSET								GWB	SEE RCP
UNIT C	205	LIVING								GWB	SEE RCP
UNIT C	206	DINING								GWB	SEE RCP
UNIT C	207	KITCHEN								GWB	SEE RCP
UNIT C	208	BED 1								GWB	SEE RCP
UNIT C	209	BED 2								GWB	SEE RCP
UNIT C	210	BATH								GWB	SEE RCP
UNIT C	211	CLOSET								GWB	SEE RCP
UNIT D	220	LIVING								GWB	SEE RCP
UNIT D	221	KITCHEN								GWB	SEE RCP
UNIT D	222	BED 1								GWB	SEE RCP
UNIT D	223	BED 2								GWB	SEE RCP
UNIT D	225	BATH								GWB	SEE RCP
UNIT D	226	CLOSET								GWB	SEE RCP
UNIT D	227	CLOSET								GWB	SEE RCP
UNIT D	228	COATS								GWB	SEE RCP
UNIT D	229	LAUNDRY								GWB	SEE RCP
UNIT E	300	ENTRY								GWB	SEE RCP
UNIT E	301	KITCHEN								GWB	SEE RCP
UNIT E	302	LIVING								GWB	SEE RCP
UNIT E	303	BED 1								GWB	SEE RCP
UNIT E	304	BED 2								GWB	SEE RCP
UNIT E	305	BED 3								GWB	SEE RCP
UNIT E	306	BATH 1								GWB	SEE RCP
UNIT E	307	BATH 2								GWB	SEE RCP
UNIT E	308	BED 4								GWB	SEE RCP
UNIT E	309	HALL								GWB	SEE RCP
UNIT E	310	CLOSET								GWB	SEE RCP
UNIT E	311	CLOSET								GWB	SEE RCP
UNIT E	312	CLOSET								GWB	SEE RCP
UNIT E	313	CLOSET								GWB	SEE RCP
UNIT E	314	CLOSET								GWB	SEE RCP
UNIT E	315	LAUNDRY								GWB	SEE RCP

**FINISH PLAN GENERAL NOTES:**

- REFER TO MATERIAL FINISH SCHEDULE ON A002 FOR KEY CODES, SELECTION AND COLOR.
- REFER TO ROOM FINISH SCHEDULE, THIS SHEET FOR ALL ROOM FINISHES NOT NOTED ON PLAN.
- ALL EXISTING WOOD FLOORING TO REMAIN. REPAIR AND REFINISH AS NEEDED, U.N.O.
- ALL WALLS TO BE PAINTED PT-1, U.N.O.
- ALL CEILINGS TO BE PAINTED PT-2, U.N.O.

FLOORING TRANSITION SCHEDULE						
FLOORING TYPE	TRANSITION	PRODUCT DESCRIPTION				REMARKS
		MFR	STYLE	COLOR		
RFT - SC	1/8" - 0"					
CPT - RFT	1/4" - 0"					
CPT - SC	1/2" - 0"					
CT - SC	3/8" - 0"					
CPT - CT	1/8" - 0"					

**FINISH PLAN SYMBOLS ABBREVIATIONS**

- |  |                     |                              |
|--|---------------------|------------------------------|
|  | FLOORING FINISH     | AFF = ABOVE FINISHED FLOOR   |
|  | FLOORING TRANSITION | CT = CERAMIC TILE            |
|  | WALL FINISH         | CTB = CERAMIC TILE BASE      |
|  | BASE FINISH         | CG = CORNER GUARD            |
|  |                     | CONC = CONCRETE              |
|  |                     | CPT = CARPET                 |
|  |                     | EM = ENTRY MAT               |
|  |                     | GWB = GYPSUM WALL BOARD      |
|  |                     | PLAM = PLASTIC LAMINATE      |
|  |                     | PT = PAINT                   |
|  |                     | LAM = LAMINATED FLOORING     |
|  |                     | QB = QUARRY BASE             |
|  |                     | QT = QUARRY TILE             |
|  |                     | RB = RUBBER WALL BASE        |
|  |                     | RFT = RUBBER FLOOR TILE      |
|  |                     | SC = SEALED CONCRETE         |
|  |                     | SV = SHEET VINYL             |
|  |                     | VCT = VINYL COMPOSITION TILE |
|  |                     | WDF = WOOD FLOORING          |
|  |                     | WDB = WOOD BASE              |
|  |                     | WDC = WOOD CROWN MOLDING     |
|  |                     | WT = WINDOW TREATMENT        |

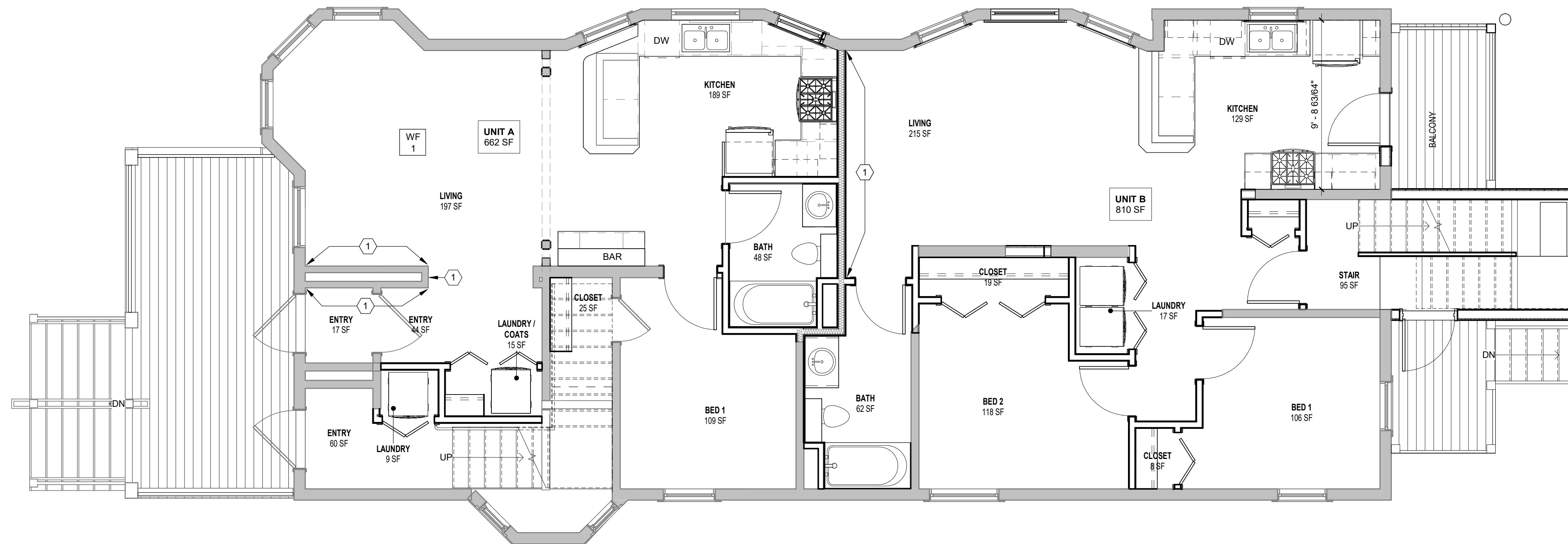

No.	Description	Date

112 South Hancock Street

Madison, WI 53703

**FIRST FLOOR FINISH PLAN AND ROOM FINISH SCHEDULE**

CONSTRUCTION DOCUMENTS	
Project number	THA-22-01
Date	06/08/2023

A121

KEYED NOTES #	
1	DECORATIVE WAINSCOTTING 42" HIGH

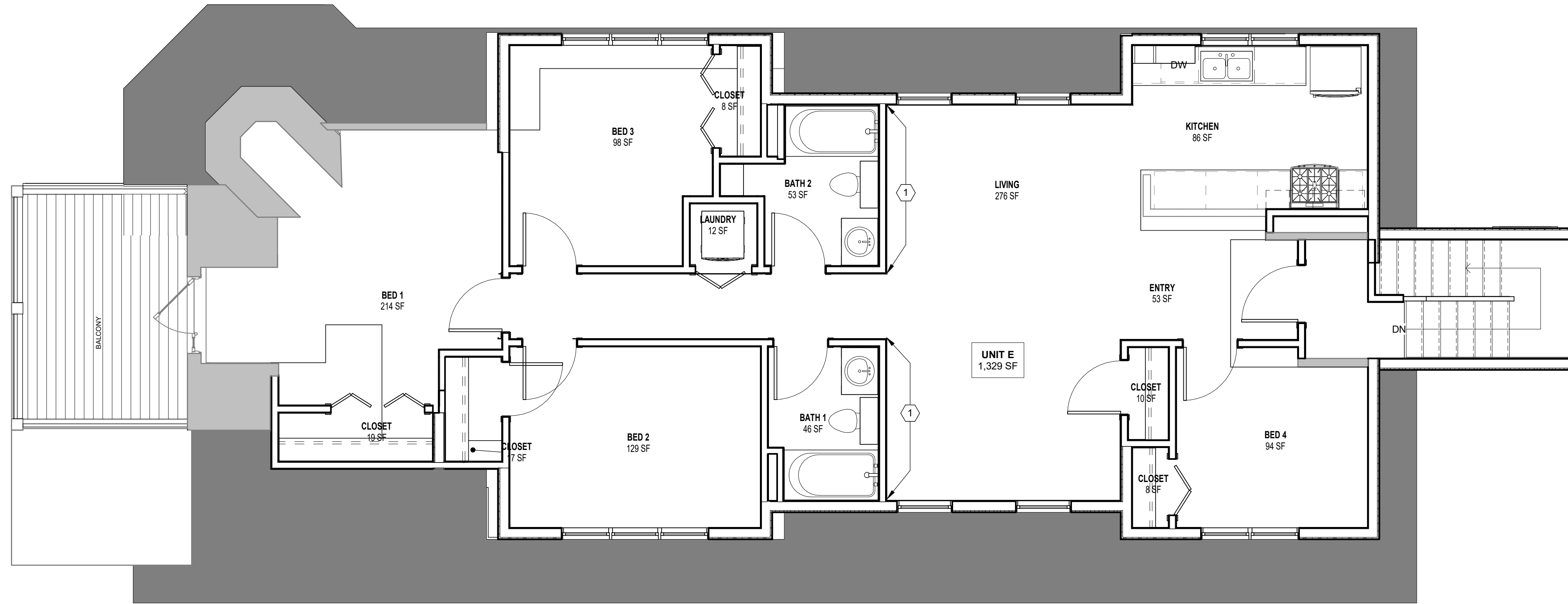

NORTH  
**1** THIRD FLOOR FINISH PLAN  
1/4" = 1'-0"

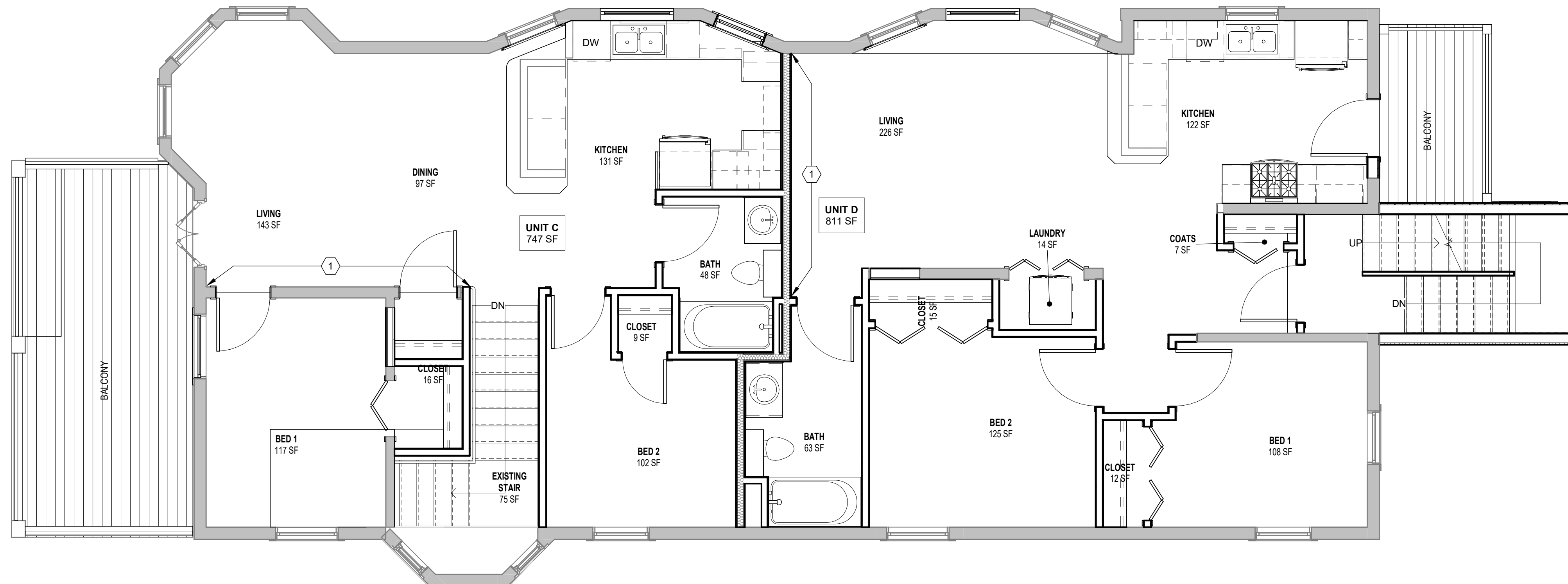

NORTH  
**2** SECOND FLOOR FINISH PLAN  
1/4" = 1'-0"

No.	Description	Date

112 South Hancock Street

Madison, WI 53703

**SECOND & THIRD FLOOR FINISH PLAN**

CONSTRUCTION DOCUMENTS	
Project number	THA-22-01
Date	06/08/2023

**A122**

**KEYED NOTES** #

1	NEW HORIZONTAL FIBER CEMENT BOARD LAP SIDING & TRIM, BASIS OF DESIGN: JAMES HARDIE PLANK LAP SIDING, SMOOTH FINISH, COLOR TBD
2	NEW ASPHALT SHINGLES
3	NEW ALUMINUM GUTTERS
4	NEW EXTERIOR WALL MOUNTED DOWNLIGHT LIGHT FIXTURE, SEE LIGHT FIXTURE SCHEDULE
5	NEW WOOD WINDOW, BASIS OF DESIGN: MARVIN ULTIMATE, SEE WINDOW SCHEDULE
6	NEW DOOR, SEE DOOR SCHEDULE
7	NEW WOOD RAILING
8	NEW BALCONY, 5/4X8 TREATED HARDWOOD OR COMPOSITE DECK BOARDS OVER 2X10 WOOD FRAMING AT 16" O.C.
9	WOOD COLUMN
10	24" DIAMETER CONCRETE SONOTUBE
11	NEW WOOD STAIR, STRINGER, AND RAILING
12	WOOD paneled GUARDRAIL, SEE DETAIL ON A501
13	MECHANICAL EQUIPMENT
14	12" DIAMETER CONCRETE SONOTUBE
15	NEW ALUMINUM DOWNSPOUT, DRAIN TO GRADE



**1 NORTH ELEVATION**  
1/4" = 1'-0"

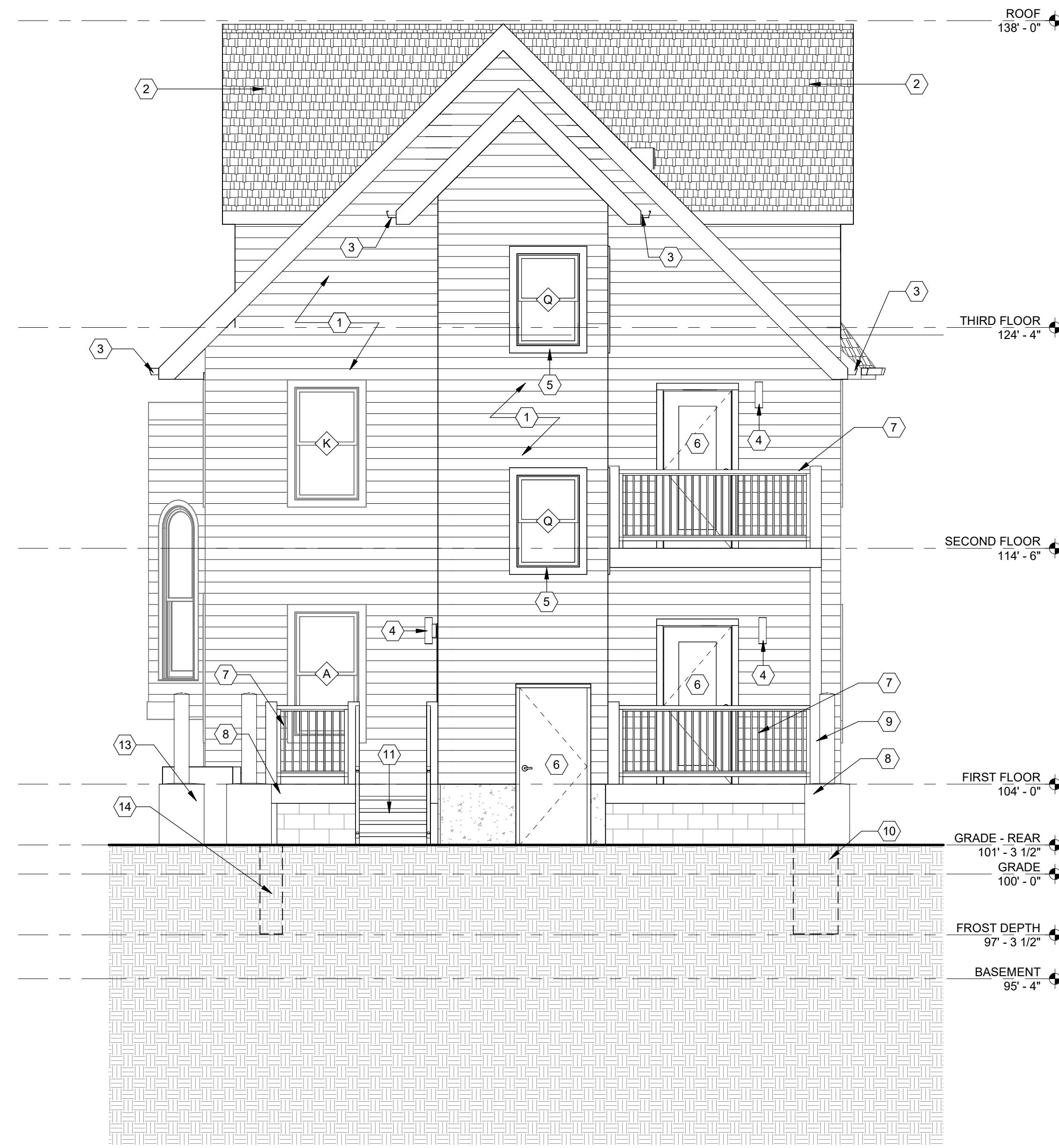

**2 SOUTH ELEVATION**  
1/4" = 1'-0"

No.	Description	Date

112 South Hancock Street

Madison, WI 53703

**EXTERIOR ELEVATIONS**

CONSTRUCTION DOCUMENTS	
Project number	THA-22-01
Date	06/08/2023

**A201**

**KEYED NOTES** #

1	EXISTING SKYLIGHT TO REMAIN
2	NEW ALUMINUM GUTTERS
3	MECHANICAL EQUIPMENT
4	NEW WOOD WINDOW; BASIS OF DESIGN: MARVIN ULTIMATE; SEE WINDOW SCHEDULE
5	NEW HORIZONTAL FIBER CEMENT BOARD LAP SIDING & TRIM; BASIS OF DESIGN: JAMES HARDIE PLANK LAP SIDING, SMOOTH FINISH, COLOR TBD
6	WOOD paneled GUARDRAIL, SEE DETAIL ON A501
7	NEW ASPHALT SHINGLES
8	NEW EXTERIOR WALL MOUNTED DOWNLIGHT LIGHT FIXTURE, SEE LIGHT FIXTURE SCHEDULE
9	NEW WOOD RAILING
10	NEW BALCONY, 5/4X6 TREATED HARDWOOD OR COMPOSITE DECK BOARDS OVER 2X10 WOOD FRAMING AT 16" O.C.
11	WOOD COLUMN
12	24" DIAMETER CONCRETE SONOTUBE
13	WOOD LATTICE
14	NEW ALUMINUM DOWNSPOUT, DRAIN TO GRADE



No.	Description	Date

**1 EAST ELEVATION**  
1/4" = 1'-0"

112 South Hancock Street

Madison, WI 53703

**EXTERIOR ELEVATIONS**

CONSTRUCTION DOCUMENTS	
Project number	THA-22-01
Date	06/08/2023

**A202**

**KEYED NOTES** #

1	NEW HORIZONTAL FIBER CEMENT BOARD LAP SIDING & TRIM, BASIS OF DESIGN: JAMES HARDIE PLANK LAP SIDING, SMOOTH FINISH, COLOR TBD
2	NEW ASPHALT SHINGLES
3	NEW EXTERIOR WALL MOUNTED DOWNLIGHT LIGHT FIXTURE, SEE LIGHT FIXTURE SCHEDULE
4	NEW ALUMINUM GUTTERS
5	WOOD LATTICE
6	WOOD paneled GUARDRAIL, SEE DETAIL ON A501
7	NEW DOOR, SEE DOOR SCHEDULE
8	NEW WOOD RAILING
9	NEW WOOD STAIR
10	NEW BALCONY, 5/4x8 TREATED HARDWOOD OR COMPOSITE DECK BOARDS OVER 2x10 WOOD FRAMING AT 16" O.C.
11	NEW WOOD WINDOW, BASIS OF DESIGN: MARVIN ULTIMATE; SEE WINDOW SCHEDULE
12	12" DIAMETER CONCRETE SONOTUBE
13	NEW ALUMINUM DOWNSPOUT, DRAIN TO GRADE



No.	Description	Date

112 South Hancock Street

Madison, WI 53703

**EXTERIOR ELEVATIONS**

CONSTRUCTION DOCUMENTS	
Project number	THA-22-01
Date	06/08/2023

**A203**

**1 WEST ELEVATION**  
1/4" = 1'-0"

KEYED NOTES #	
1	NEW EXTERIOR WALL ASSEMBLY: 2X6 WOOD STUD WITH BATT INSULATION, 3/4" PLYWOOD SHEATHING, AIRWEATHER BARRIER, HORIZONTAL FIBER CEMENT BOARD LAP SIDING
2	SOFFIT; BASIS OF DESIGN: JAMES HARDIE SOFFIT PANELS
3	NEW WOOD WINDOW; BASIS OF DESIGN: MARVIN ULTIMATE; SEE WINDOW SCHEDULE

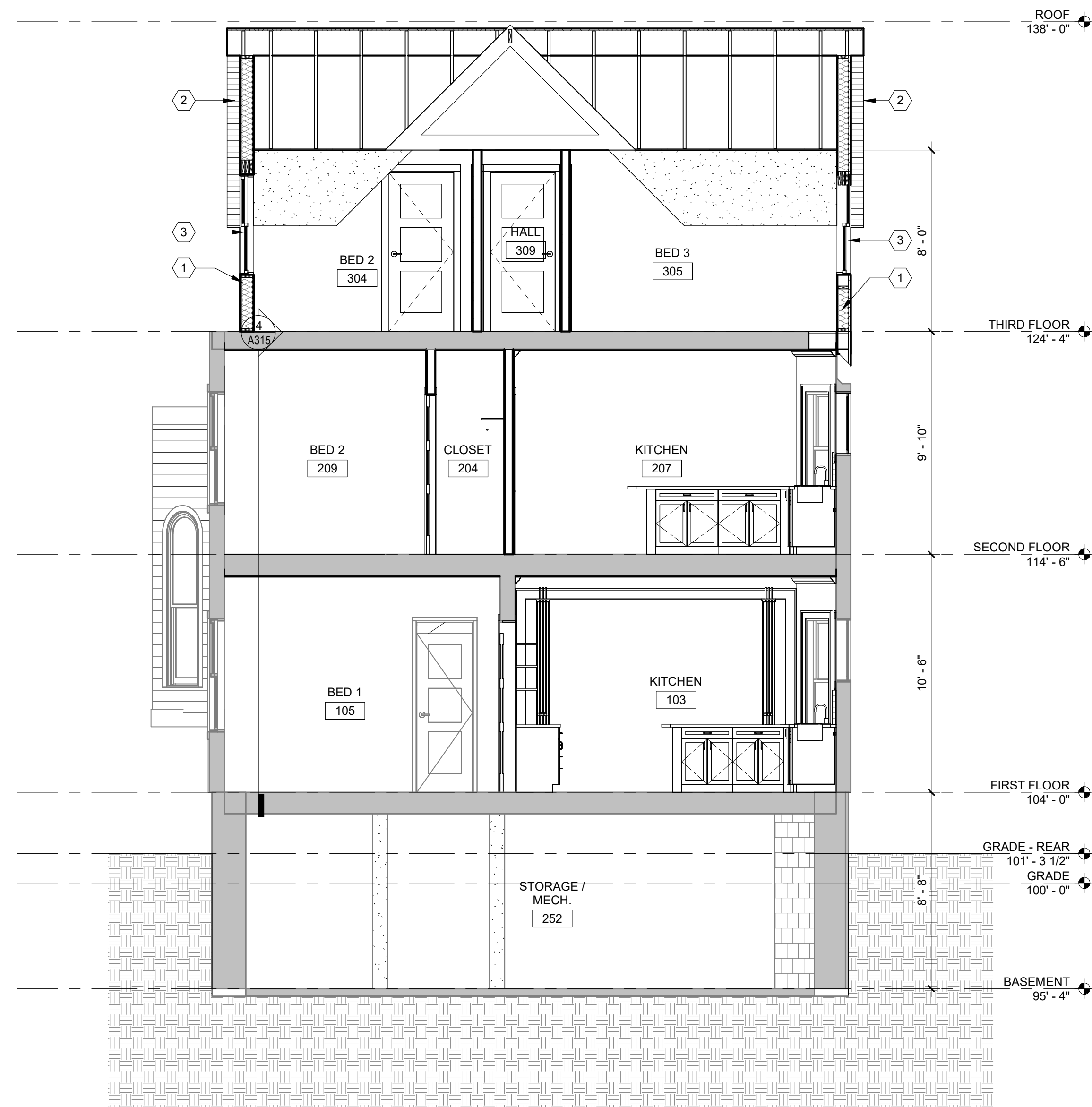

**2 BUILDING SECTION AT GABLE DORMER LOOKING NORTH**  
1/4" = 1'-0"

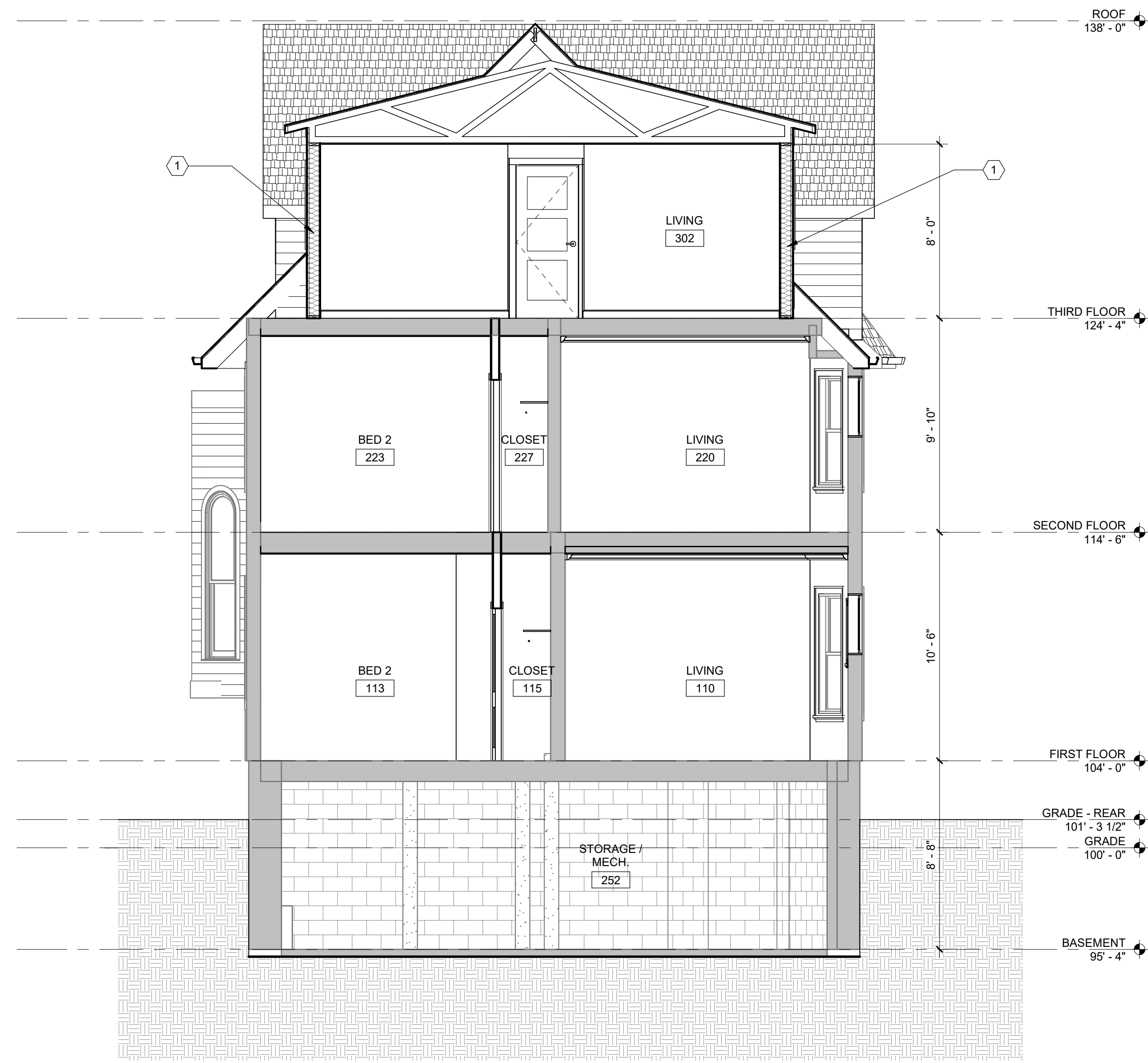

**1 BUILDING SECTION AT SHED DORMER**  
1/4" = 1'-0"

No.	Description	Date

112 South Hancock Street

Madison, WI 53703

**BUILDING SECTIONS**

CONSTRUCTION DOCUMENTS	
Project number	THA-22-01
Date	06/08/2023

**A301**



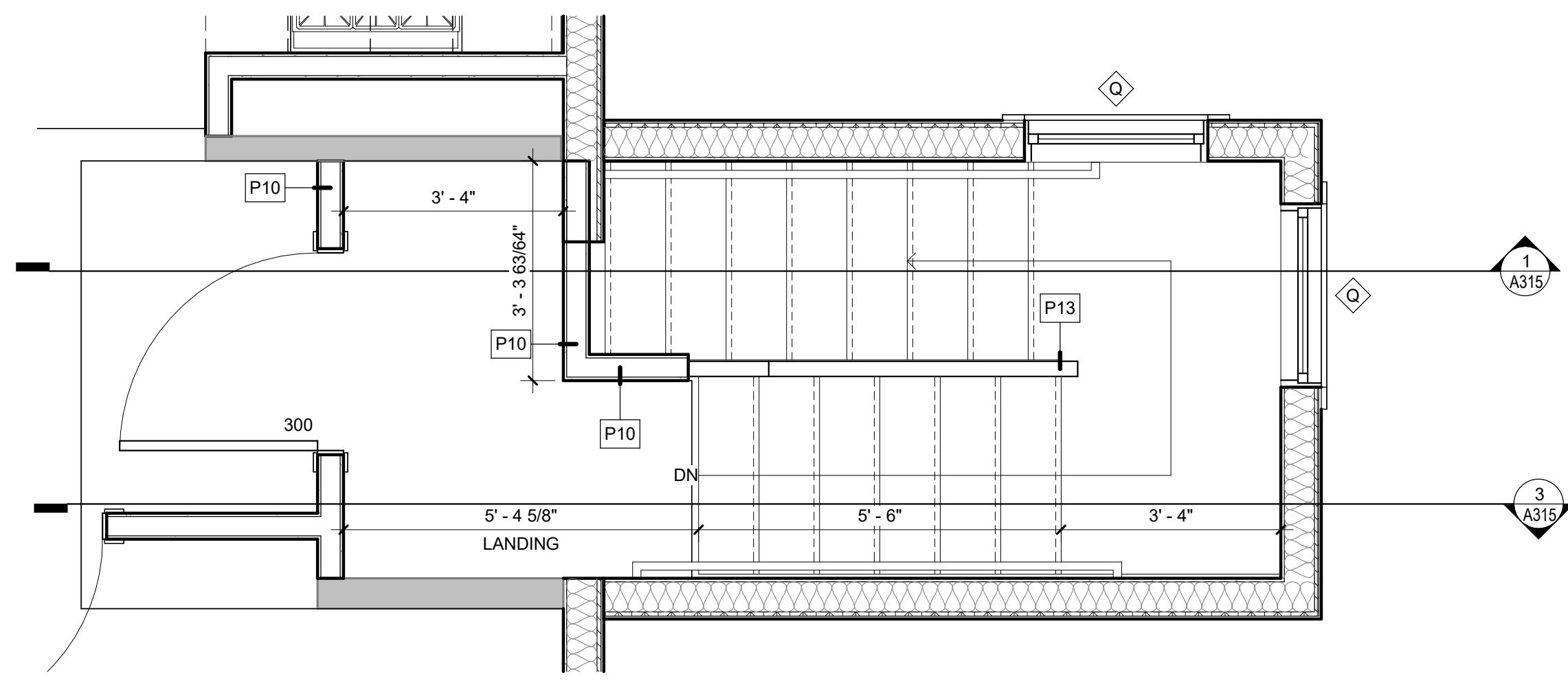

**3 THIRD FLOOR - ENLARGED STAIR #1 PLAN**  
1/2" = 1'-0"

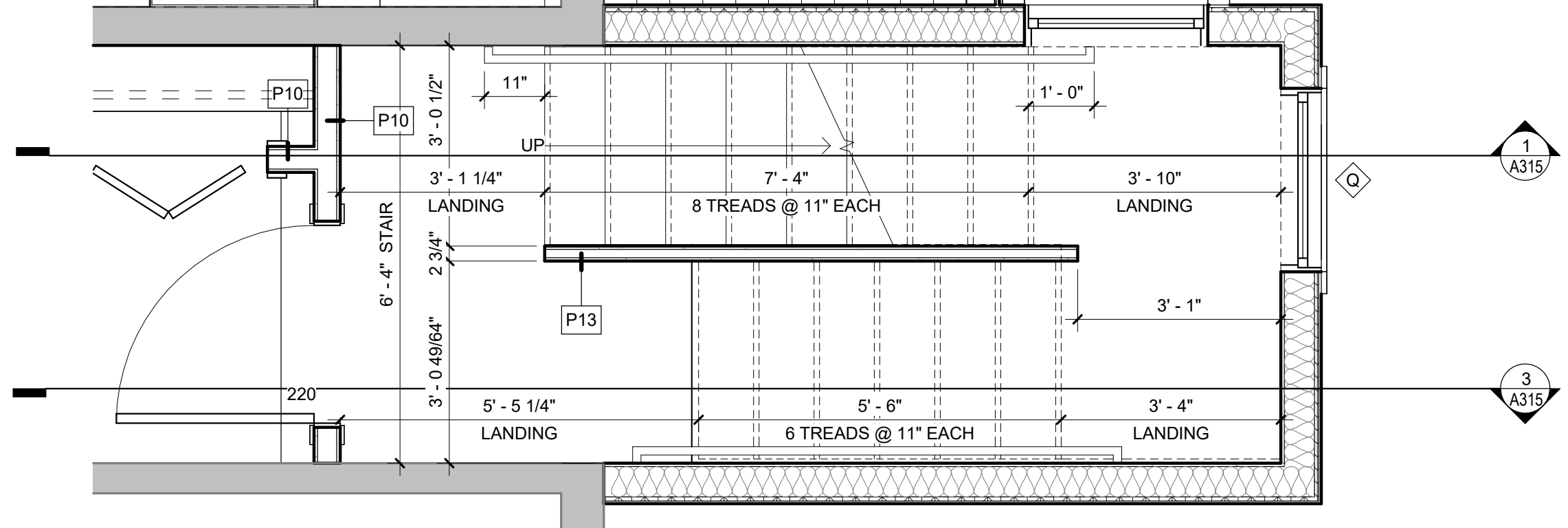

**4 SECOND FLOOR - ENLARGED STAIR #1 PLAN**  
1/2" = 1'-0"

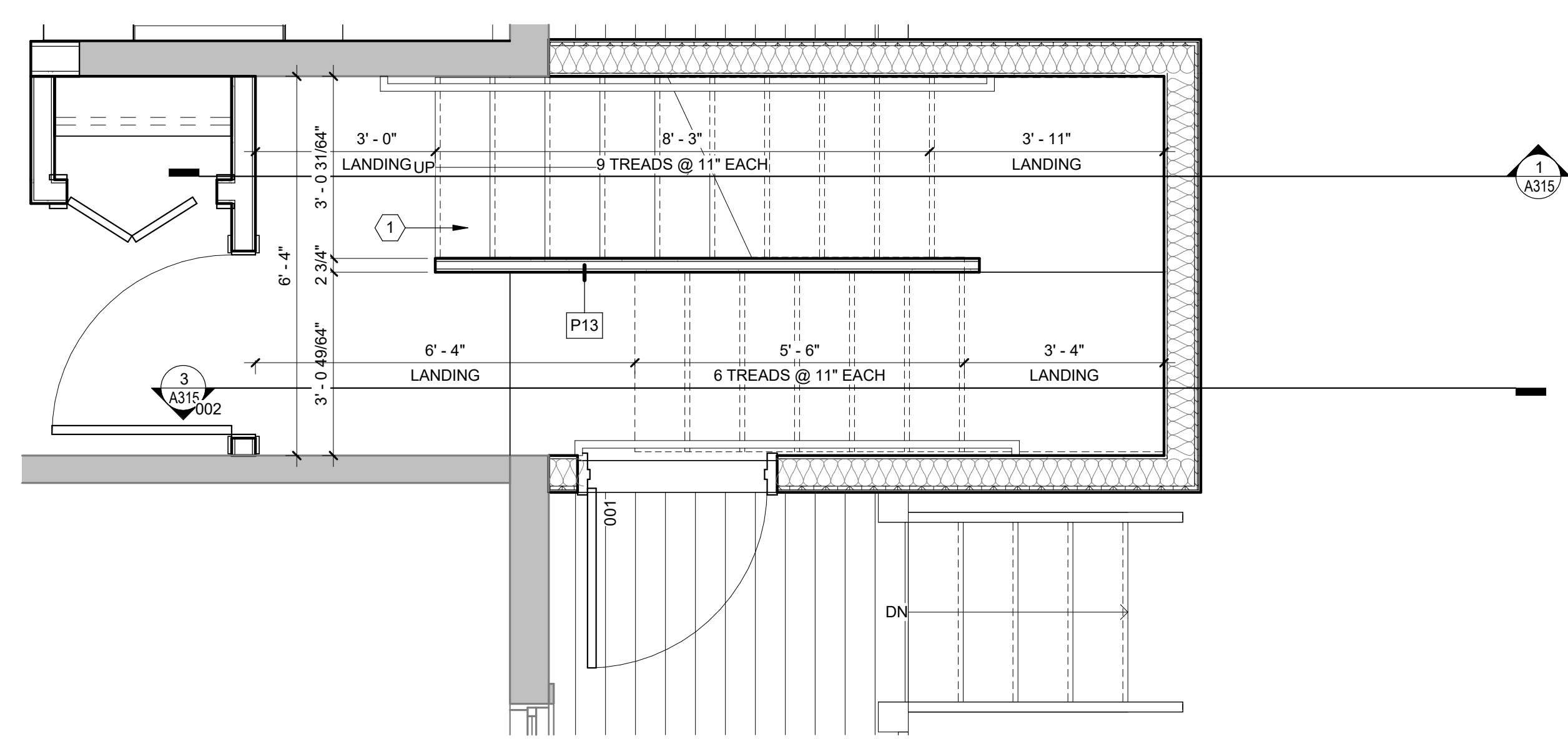

**5 FIRST FLOOR - ENLARGED STAIR #1 PLAN**  
1/2" = 1'-0"

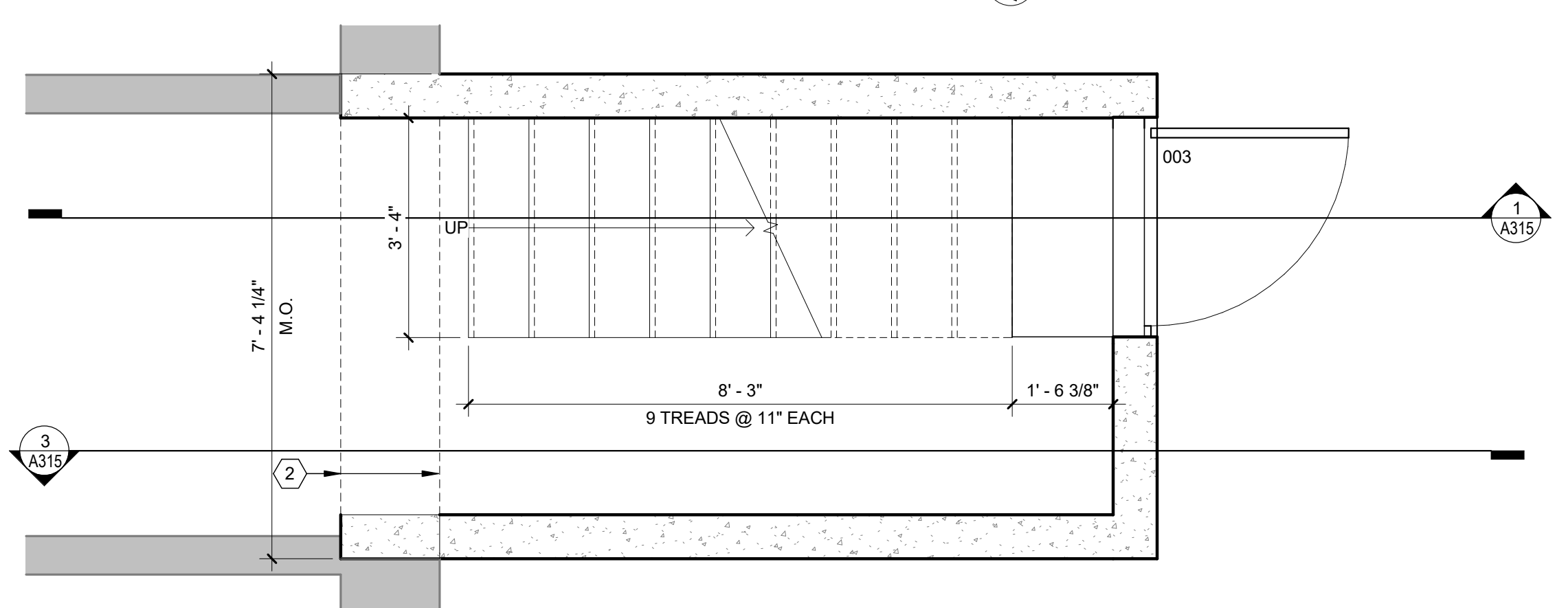

**6 BASEMENT - ENLARGED STAIR #1 PLAN**  
1/2" = 1'-0"

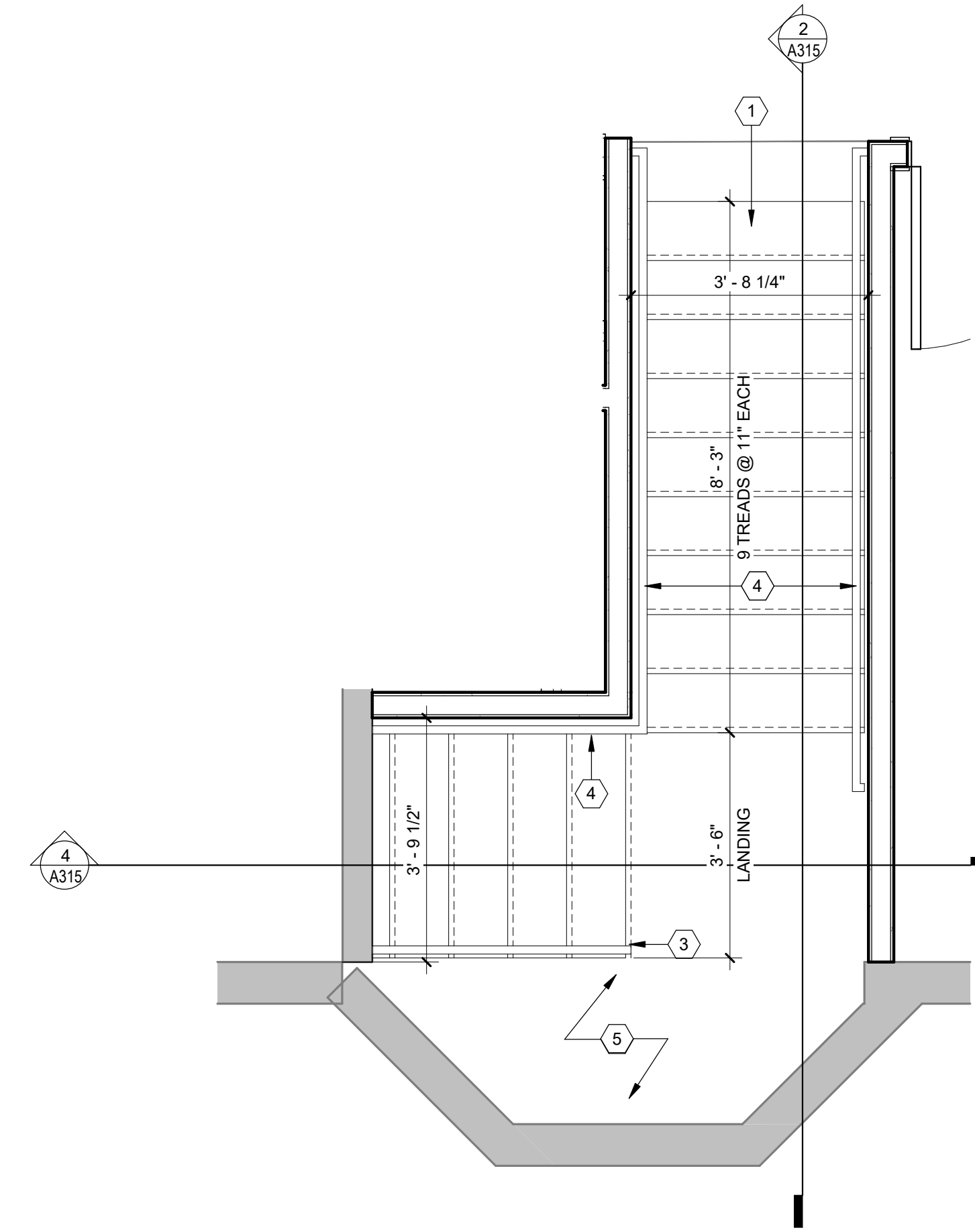

**1 SECOND FLOOR - ENLARGED STAIR #2 PLAN**  
1/2" = 1'-0"

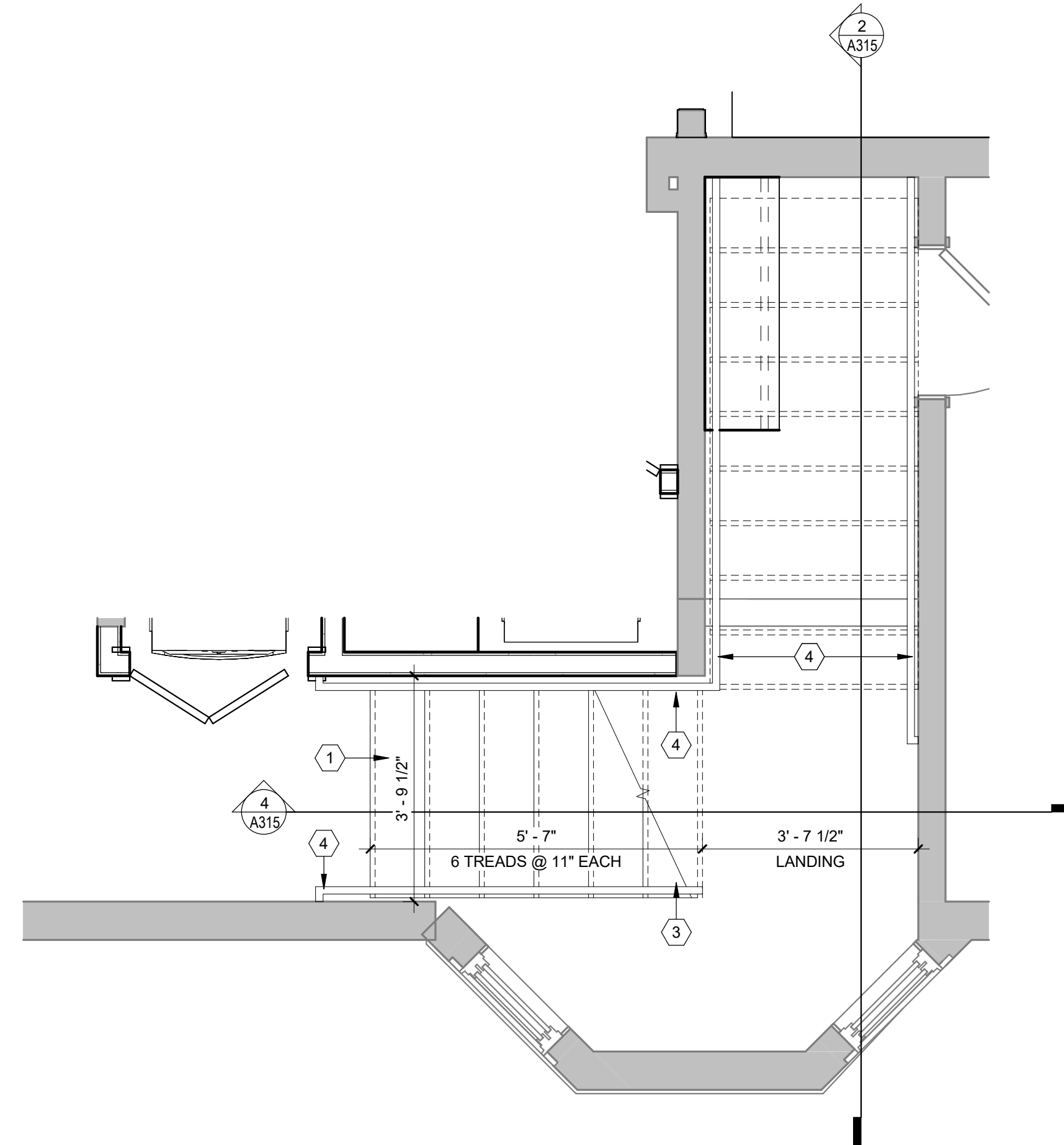

**2 FIRST FLOOR - ENLARGED STAIR #2 PLAN**  
1/2" = 1'-0"

No.	Description	Date

112 South Hancock Street

Madison, WI 53703

STAIR PLANS

CONSTRUCTION DOCUMENTS	
Project number	THA-22-01
Date	06/08/2023

A314

KEYED NOTES #	
1	WOOD STAIR
2	WOOD HANDRAIL
3	2X10 WOOD FRAMED FLOOR
4	NEW STEEL HEADER FOR OPENING IN FOUNDATION WALL
5	NEW FLOOR INFILL
6	SLOPED GWB CEILING
7	CLOSET SHELF AND POLE
8	LIGHT FIXTURE
9	WOOD HANDRAIL, RETURN TO FLOOR

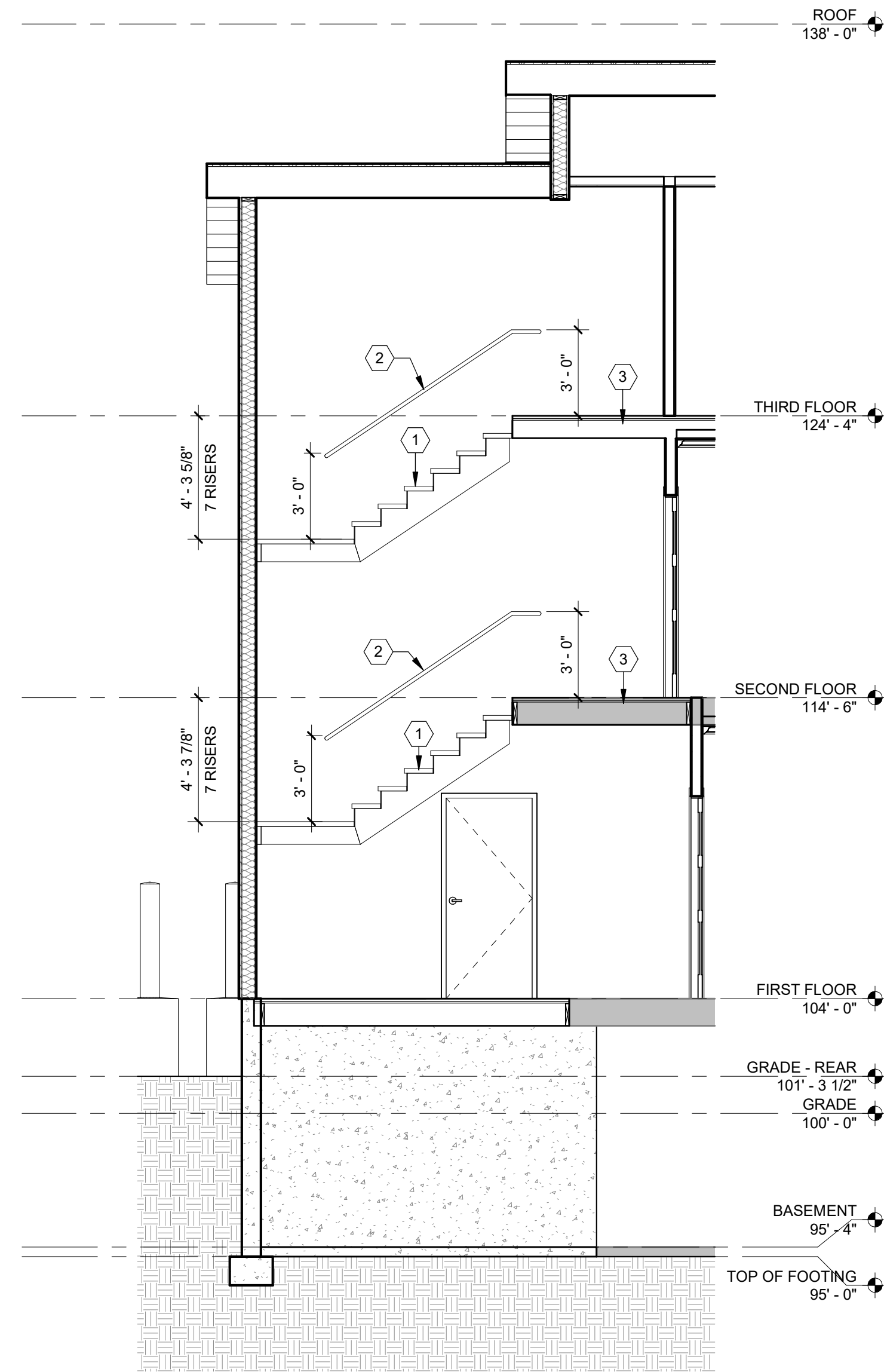

**3 STAIR #1 - SECTION 1**  
1/4" = 1'-0"

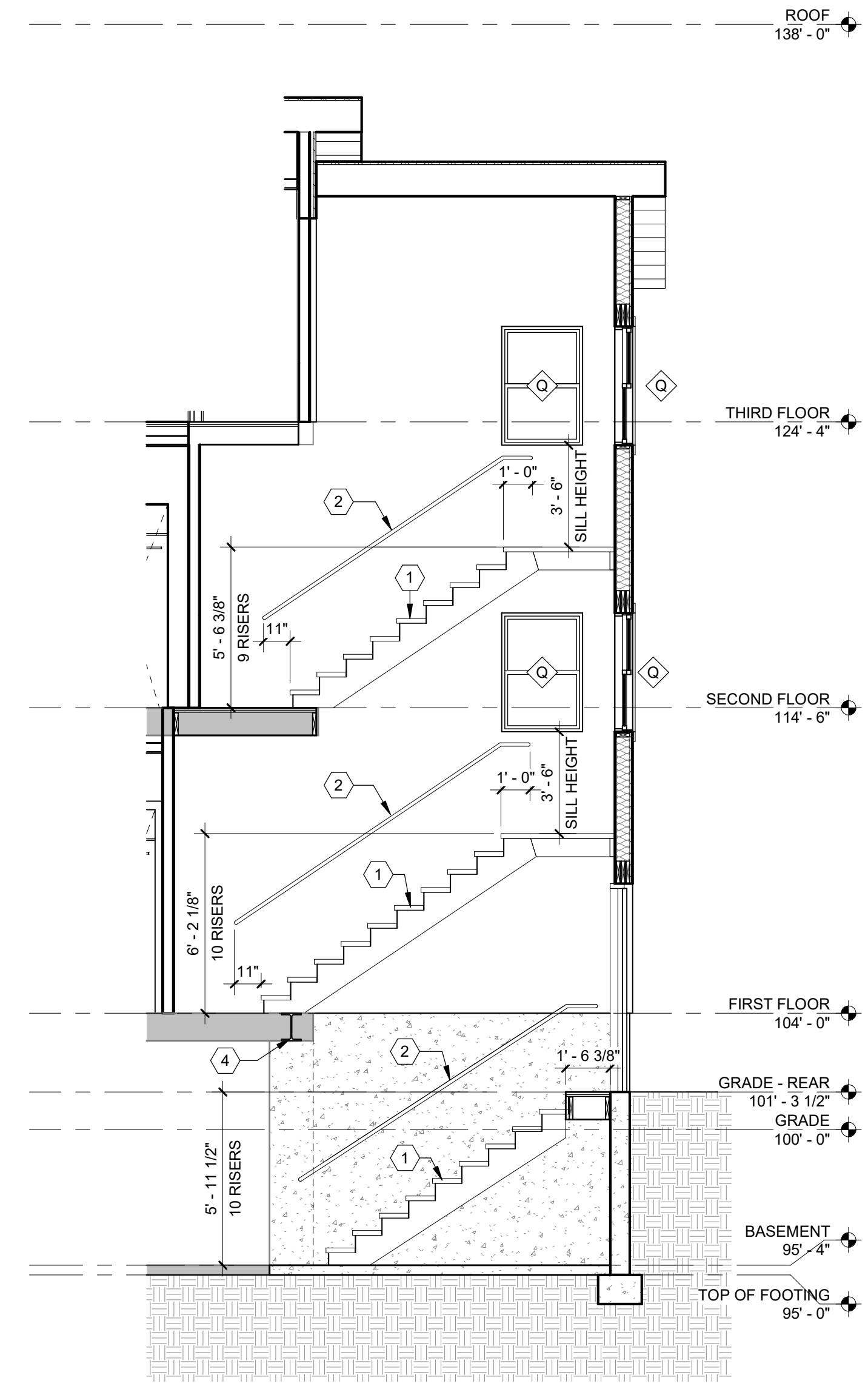

**1 STAIR #1 - SECTION 2**  
1/4" = 1'-0"

No.	Description	Date

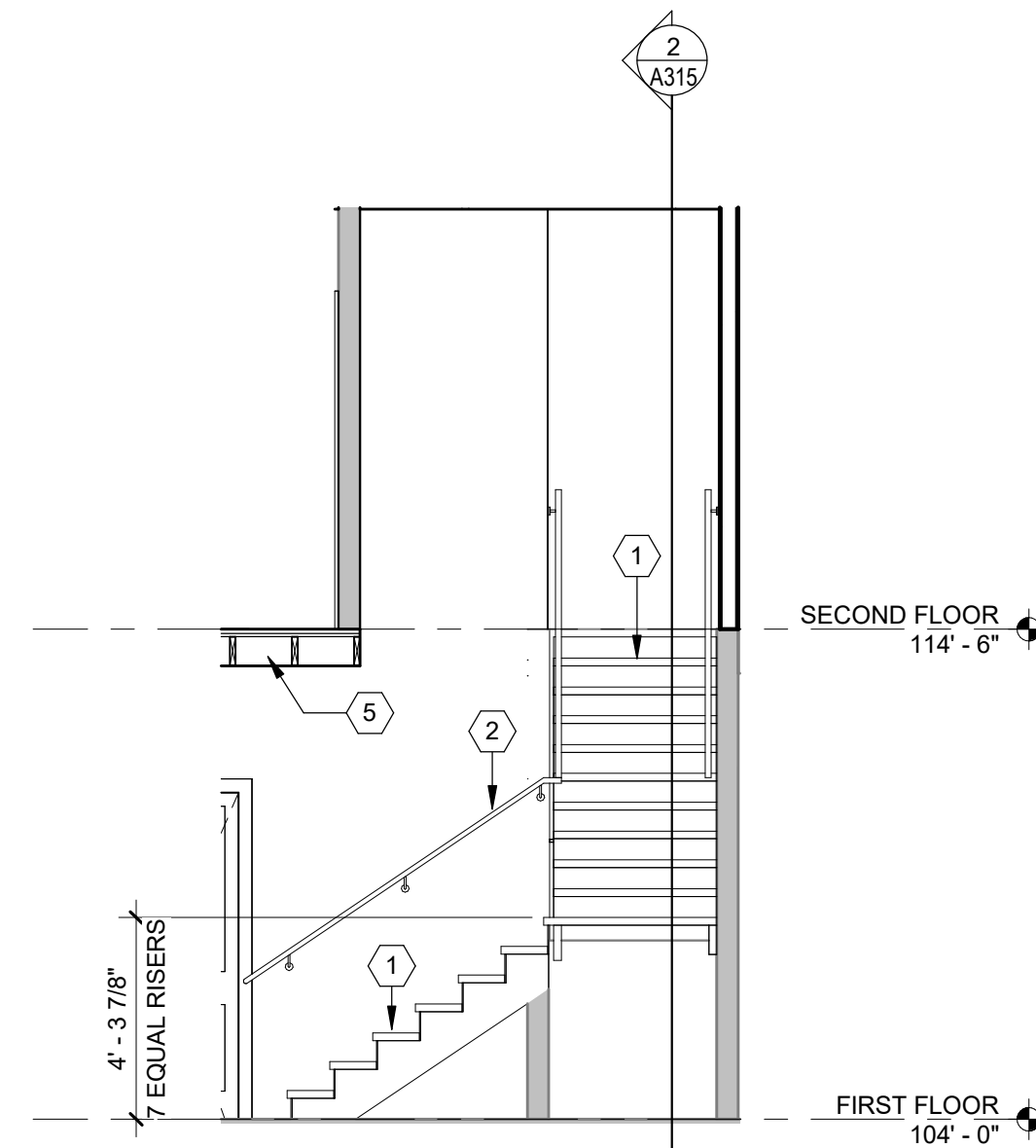

**4 STAIR #2 - SECTION 1**  
1/4" = 1'-0"

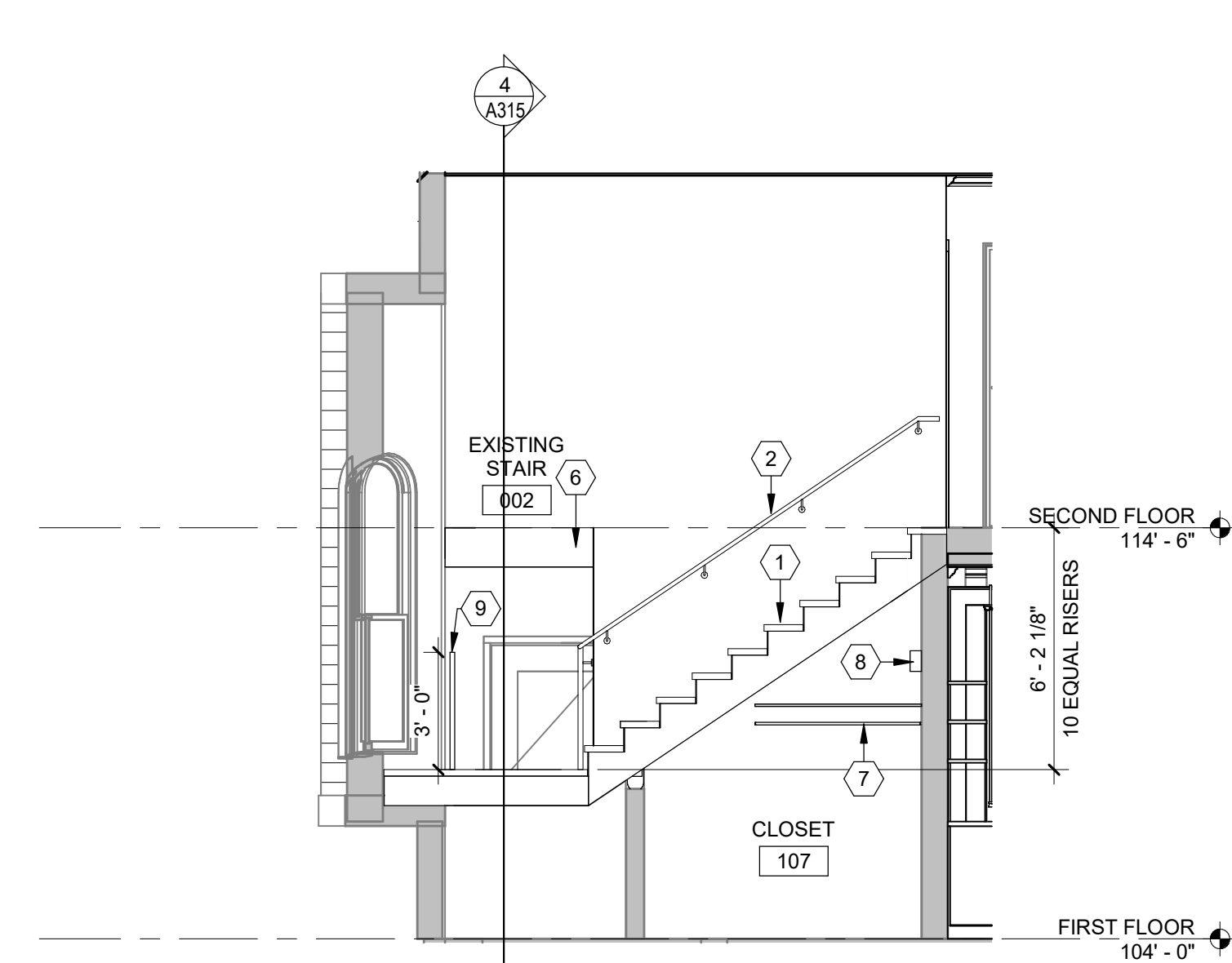

**2 STAIR #2 - SECTION 2**  
1/4" = 1'-0"

112 South Hancock Street

Madison, WI 53703

**STAIR SECTIONS**

CONSTRUCTION DOCUMENTS	
Project number	THA-22-01
Date	06/08/2023

**A315**



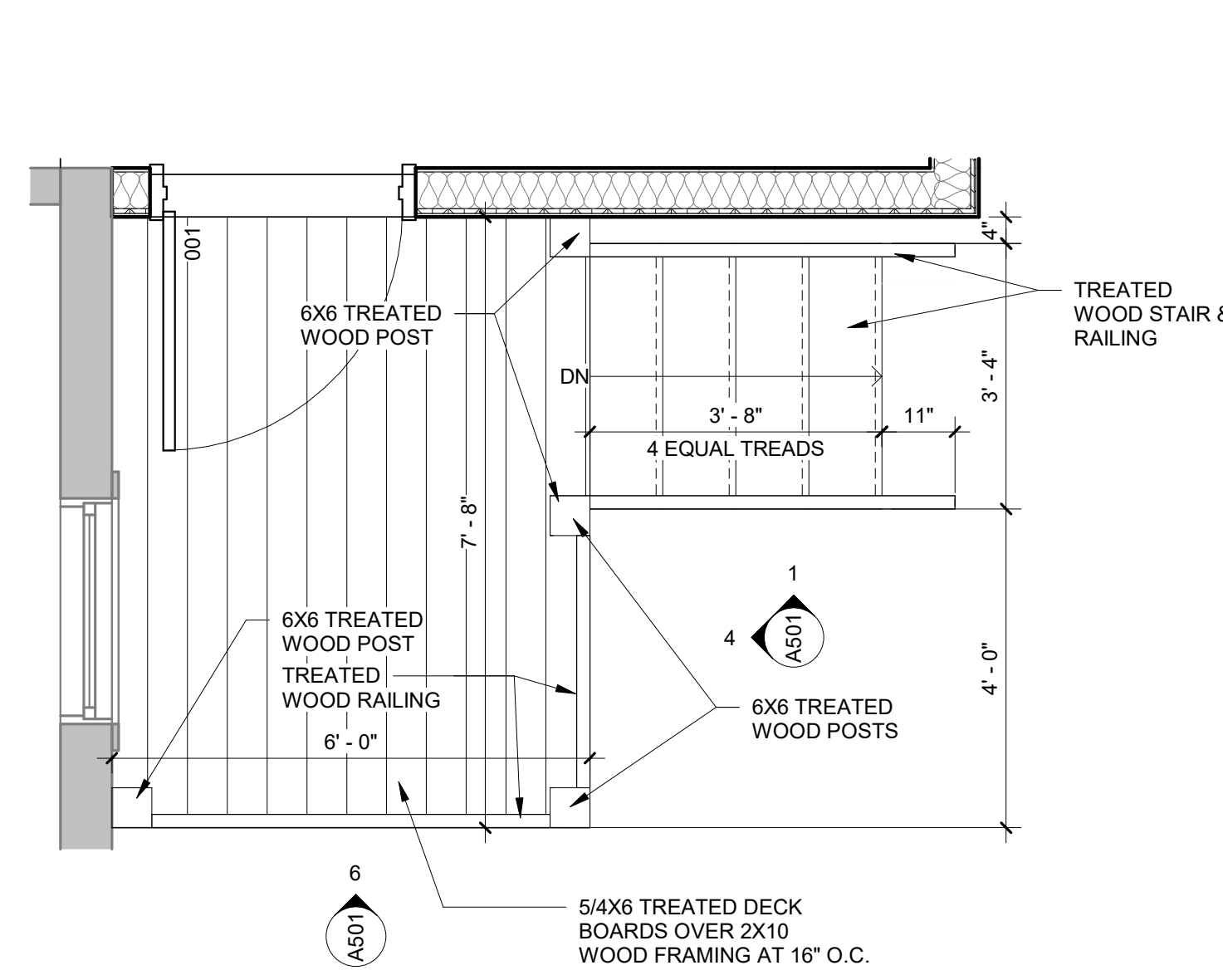

**8** **SOUTHWEST PATIO - ENLARGED PLAN**  
1/2" = 1'-0"

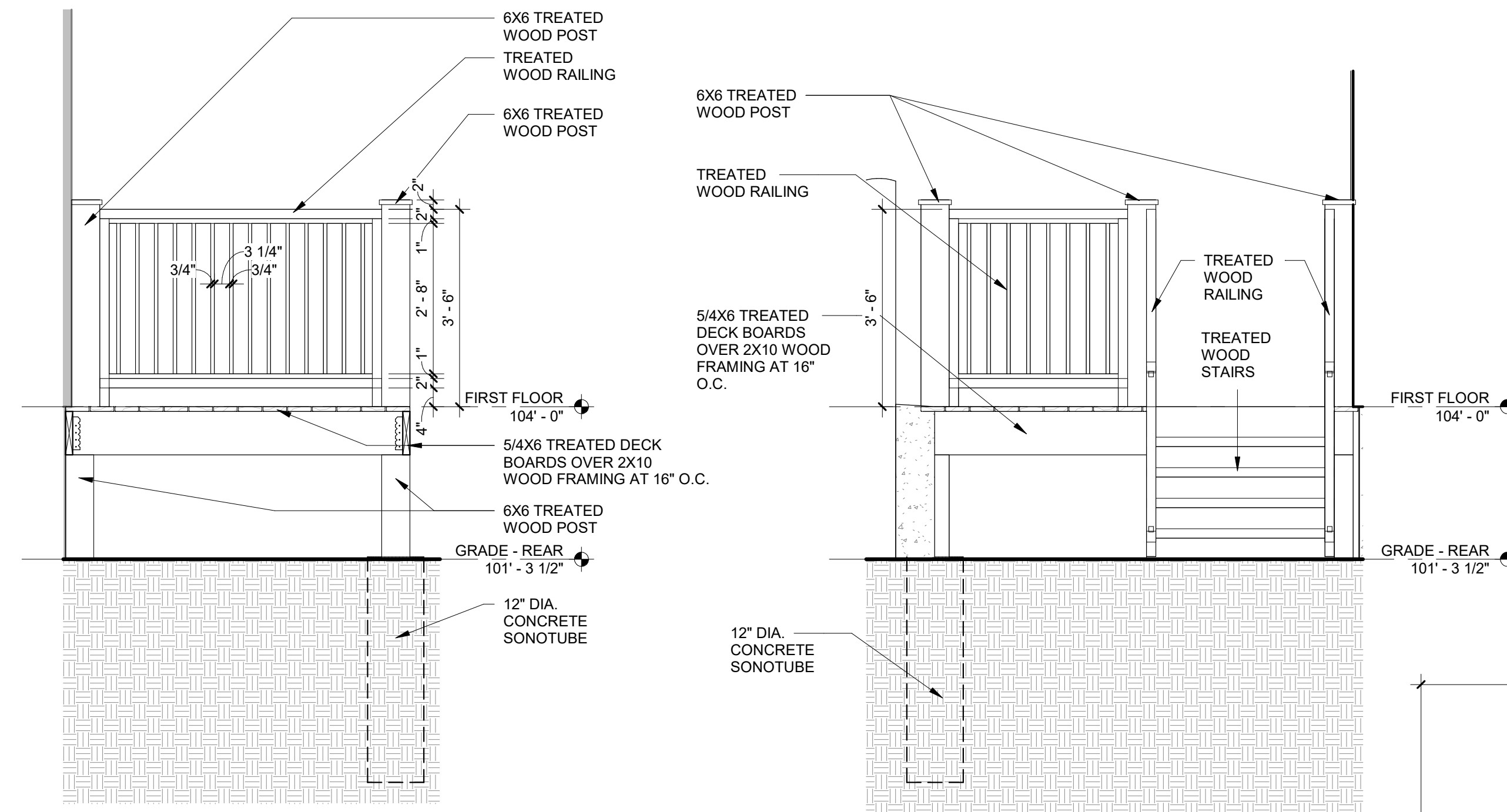

**4** **SOUTHWEST PATIO - 1**  
1/2" = 1'-0"

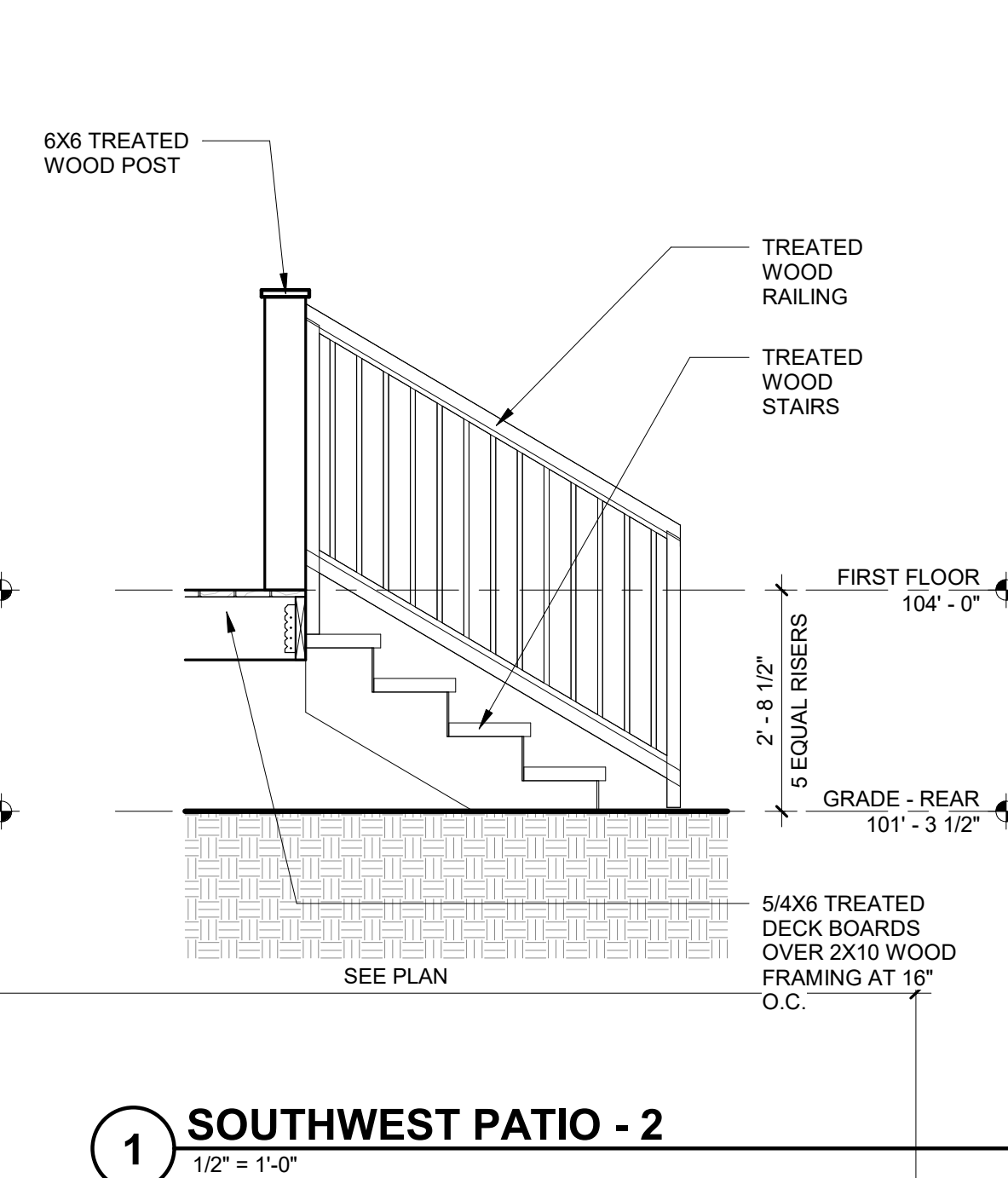

**1** **SOUTHWEST PATIO - 2**  
1/2" = 1'-0"

**6** **SOUTHWEST PATIO - 3**  
1/2" = 1'-0"

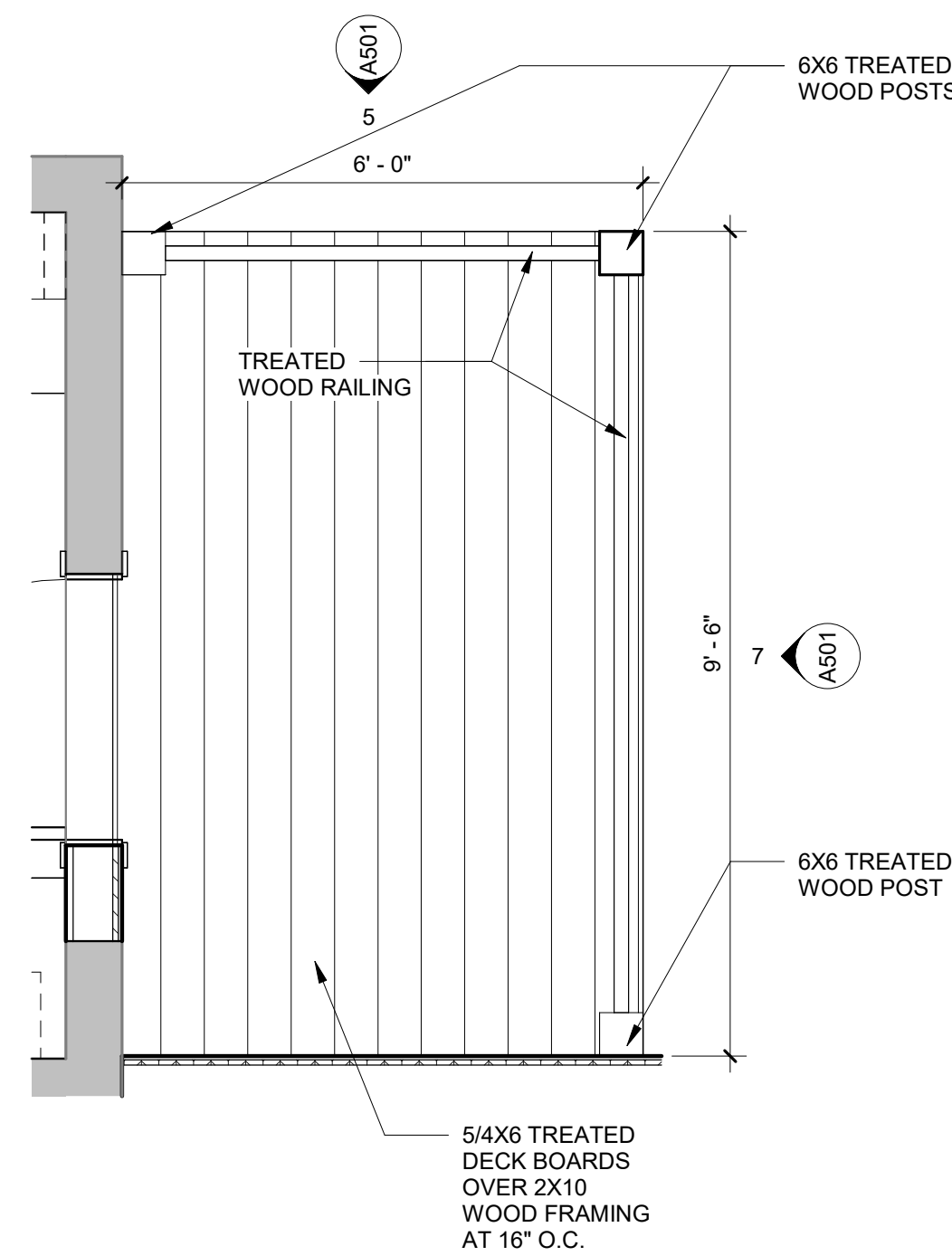

**9** **SOUTHEAST PATIO - ENLARGED PLAN**  
1/2" = 1'-0"

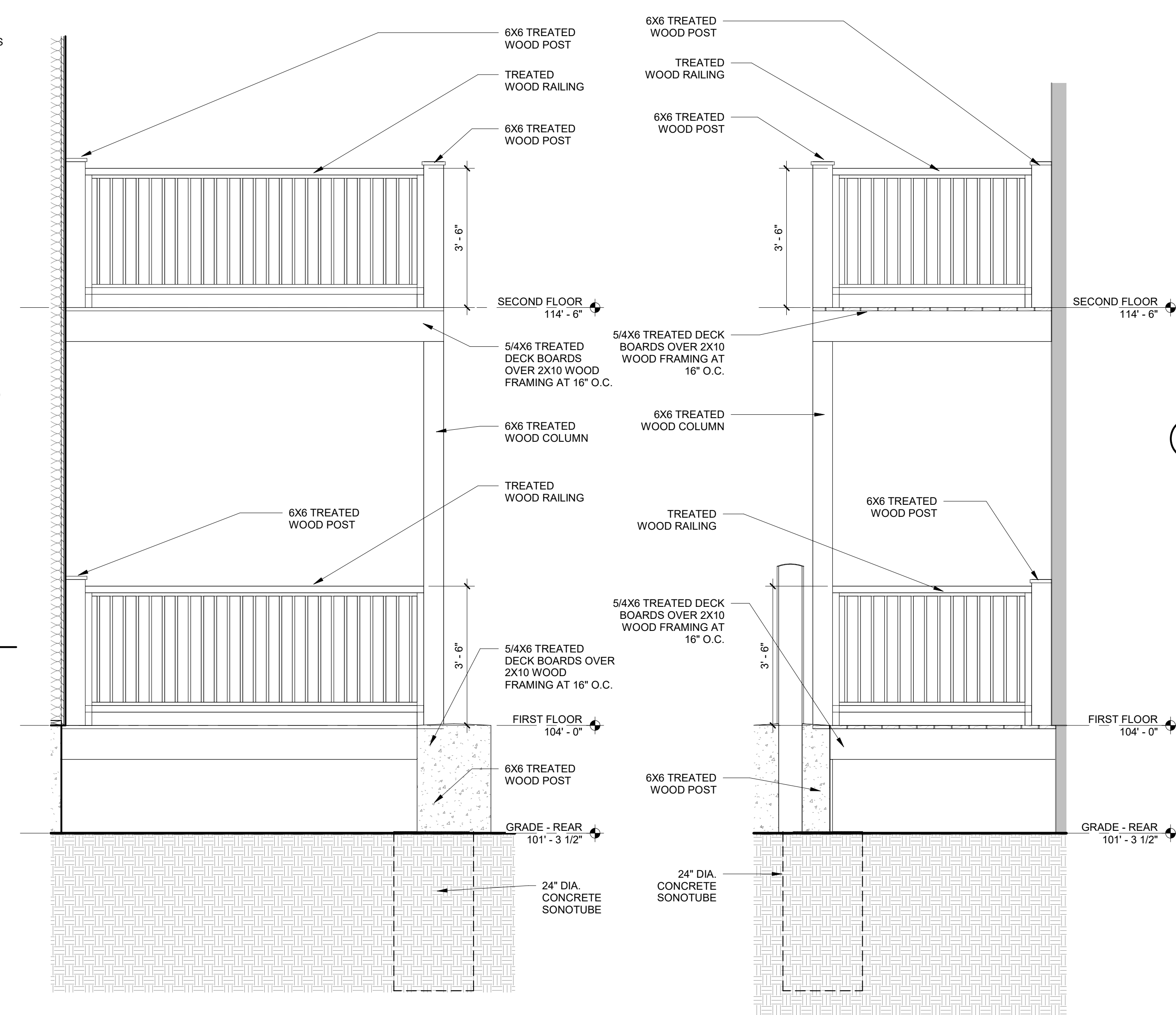

**7** **SOUTHEAST PATIO - 1**  
1/2" = 1'-0"

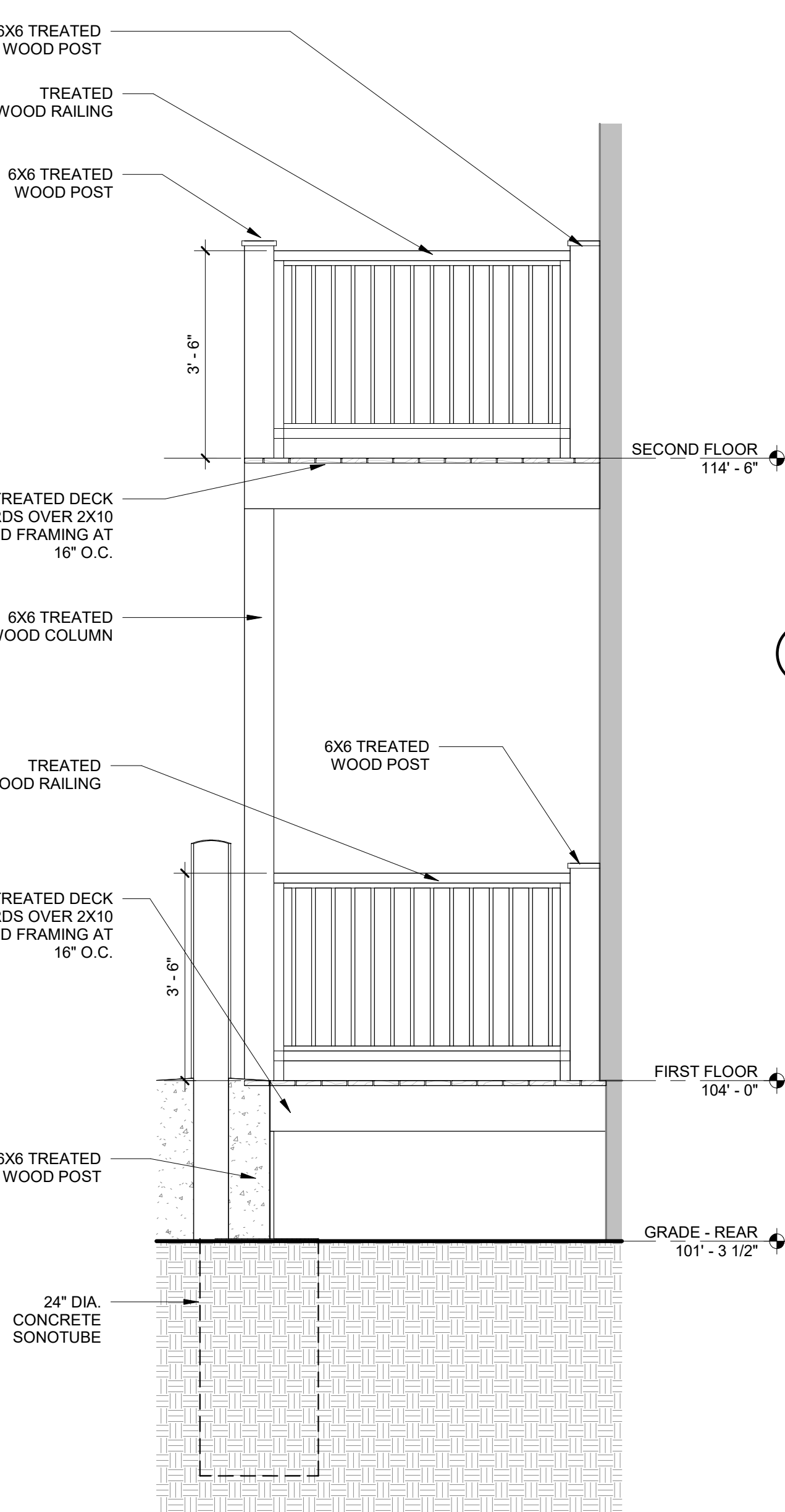

**5** **SOUTHEAST PATIO - 2**  
1/2" = 1'-0"

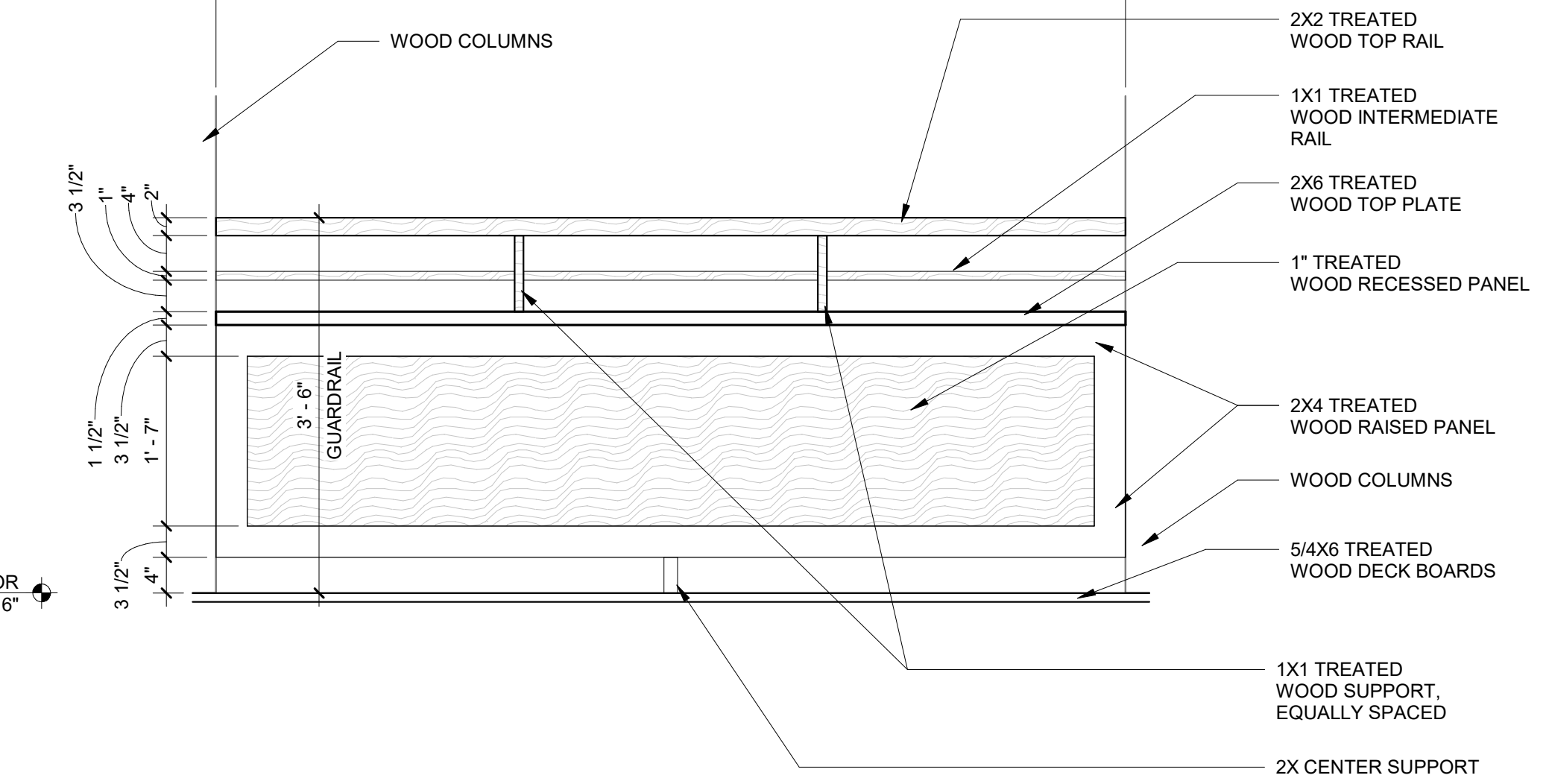

**2** **FRONT PORCH RAILING DETAIL - ELEVATION**  
3/4" = 1'-0"

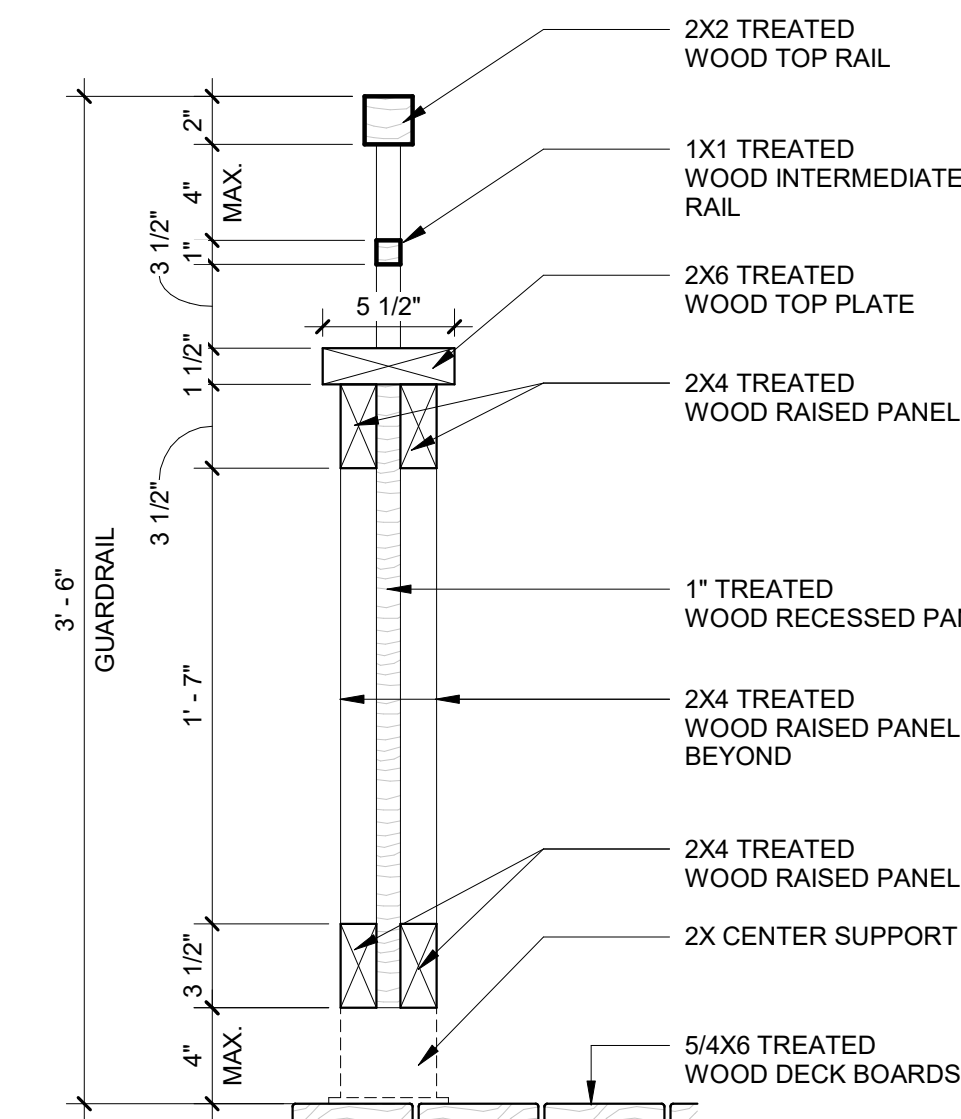

**3** **FRONT PORCH RAILING DETAIL - SECTION**  
1 1/2" = 1'-0"

No.	Description	Date

112 South Hancock Street

Madison, WI 53703

**EXTERIOR DETAILS**

CONSTRUCTION DOCUMENTS

Project number	THA-22-01
Date	06/08/2023

**A501**