



City of Madison

Proposed Demolition & Conditional Use

Location
1603-1609 Monroe Street

Project Name
Shimanski Conditional Use

Applicant
Gregg Shimanski /
Paul Cuta - CaS4 Architecture, LLC

Existing Use
Commercial building & single-family residence

Proposed Use
Revised plans for mixed-use
building with 5,000 sq. ft of
commercial and 44 apartments

Public Hearing Date
Plan Commission
09 January 2017

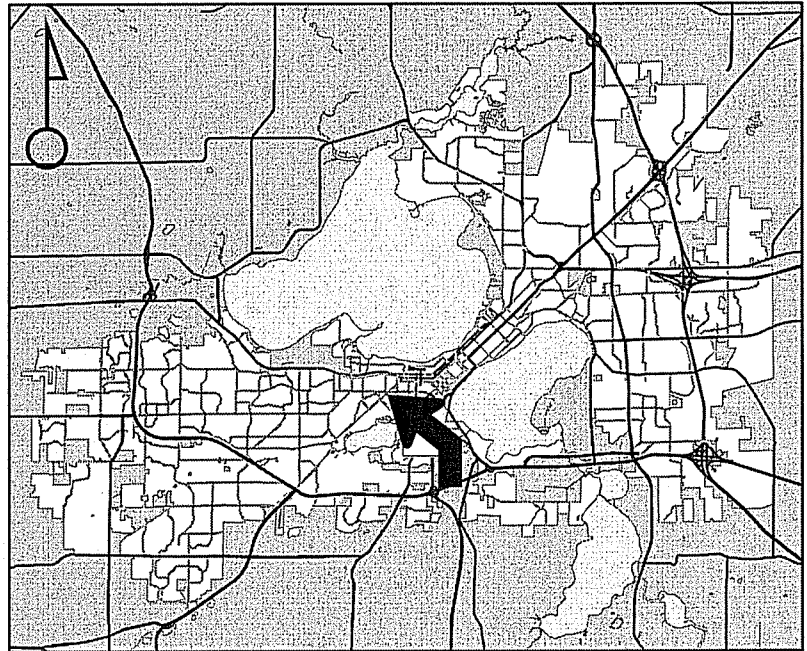

For Questions Contact: Kevin Firchow at: 267-1150 or kfirchow@cityofmadison.com or City Planning at 266-4635

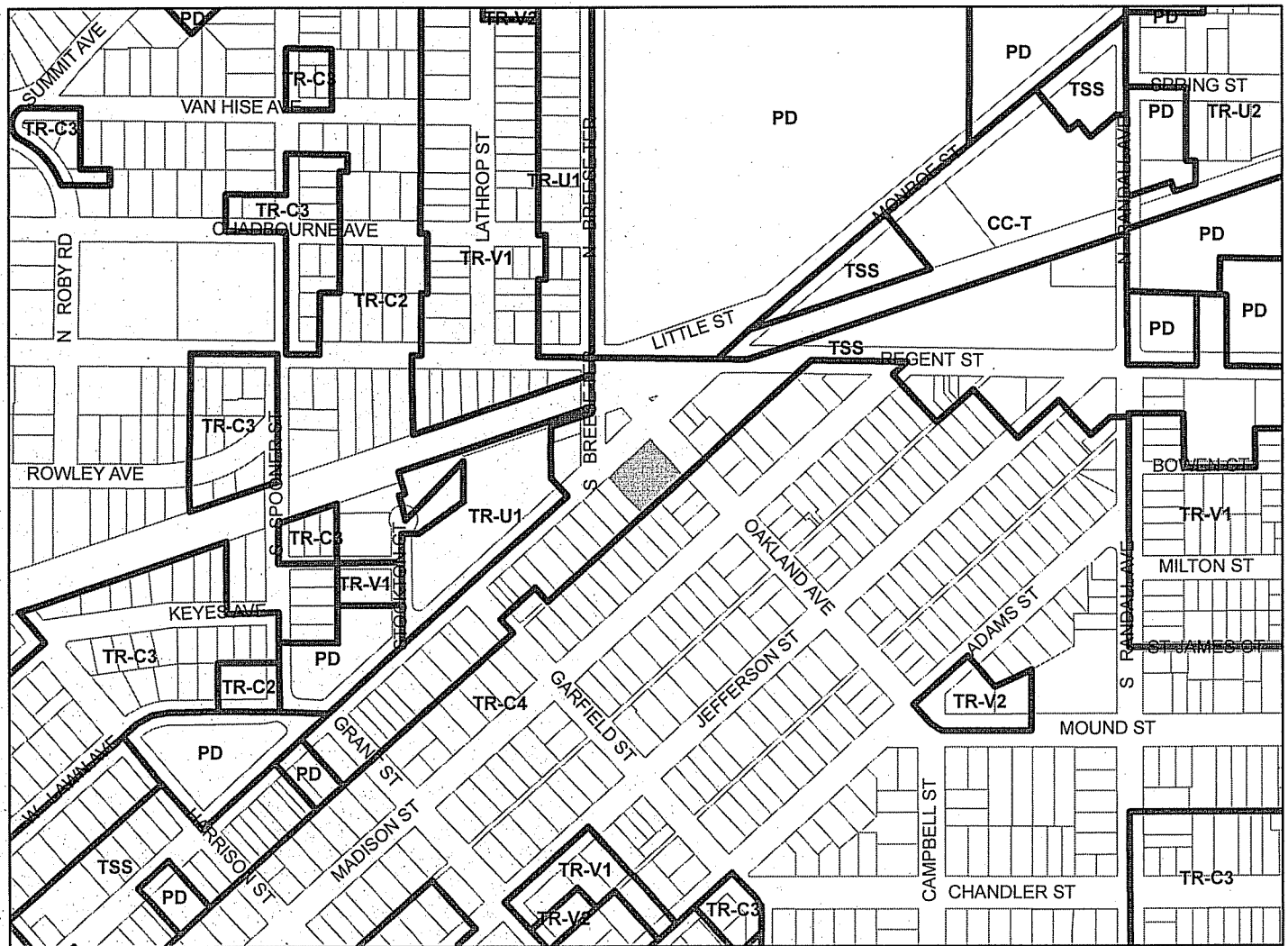

Scale : 1" = 400'

City of Madison, Planning Division : PPE : Date : 04 January 2017

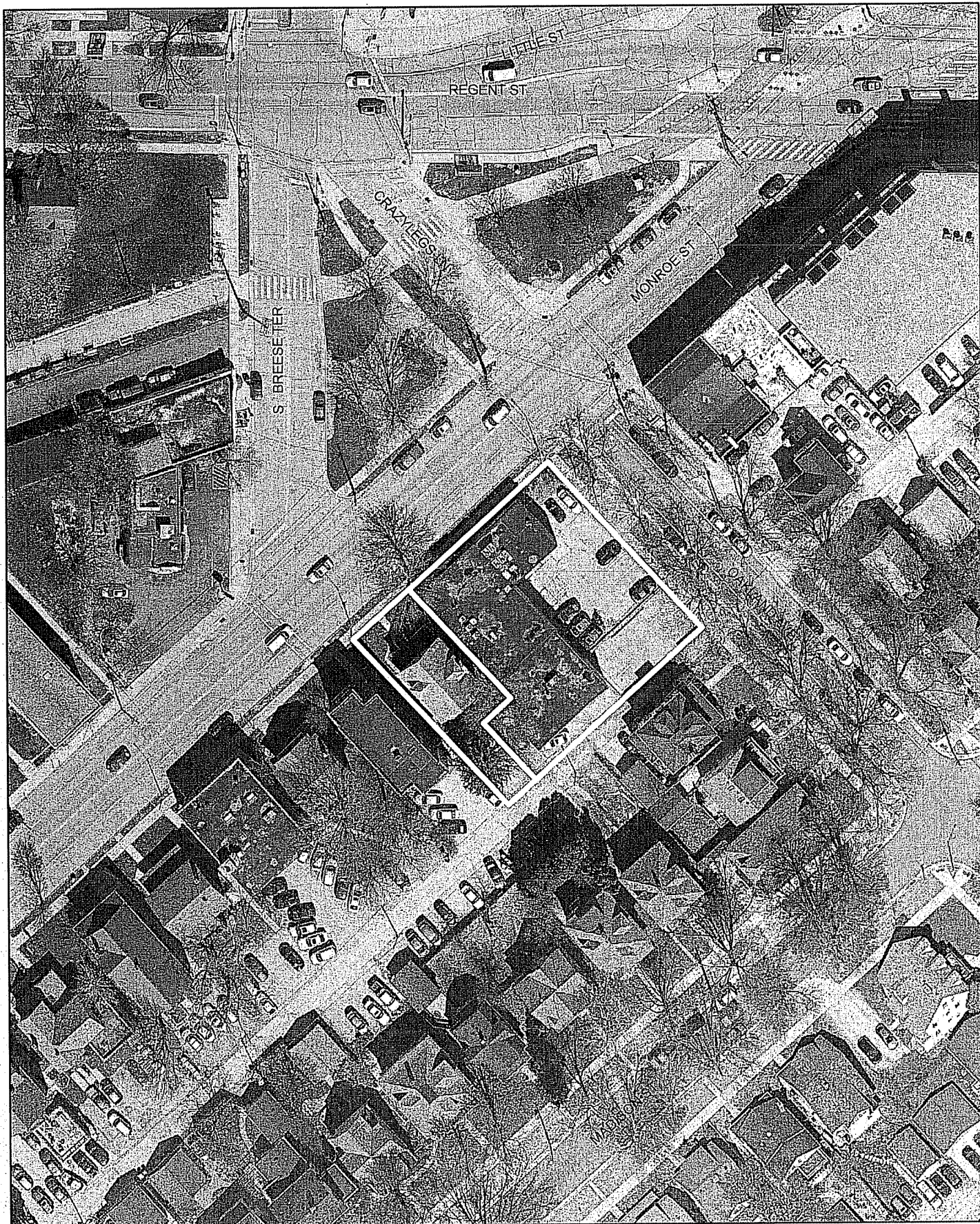



LAND USE APPLICATION

CITY OF MADISON

215 Martin Luther King Jr. Blvd; Room LL-100
PO Box 2985; Madison, Wisconsin 53701-2985
Phone: 608.266.4635 | Facsimile: 608.267.8739

- All Land Use Applications should be filed with the Zoning Administrator at the above address.
- The following information is required for all applications for Plan Commission review except subdivisions or land divisions, which should be filed using the Subdivision Application.
- This form may also be completed online at:
www.cityofmadison.com/developmentcenter/landdevelopment

FOR OFFICE USE ONLY:	
Amt. Paid _____	Receipt No. _____
Date Received _____	
Received By _____	
Parcel No. _____	
Aldermanic District _____	
Zoning District _____	
Special Requirements _____	
Review Required By:	
<input type="checkbox"/> Urban Design Commission	<input type="checkbox"/> Plan Commission
<input type="checkbox"/> Common Council	<input type="checkbox"/> Other: _____

Form Effective: February 21, 2013

1. **Project Address:** 1603 Monroe Street
Project Title (if any): _____

2. **This is an application for** (Check all that apply to your Land Use Application):

- Zoning Map Amendment from _____ to _____
- Major Amendment to Approved PD-GDP Zoning Major Amendment to Approved PD-SIP Zoning
- Review of Alteration to Planned Development (By Plan Commission)
- Conditional Use, or **Major Alteration to an Approved Conditional Use**
- Demolition Permit
- Other Requests: _____

3. **Applicant, Agent & Property Owner Information:**

Applicant Name: Paul Cuta **Company:** CāS4 Architecture, LLC
Street Address: 303 S. Paterson, Ste. 1 **City/State:** Madison, WI **Zip:** 53703
Telephone: (608) 345-1114 **Fax:** () **Email:** paul@cas4arch.com

Project Contact Person: Same as noted above **Company:** _____
Street Address: _____ **City/State:** _____ **Zip:** _____
Telephone: () **Fax:** () **Email:** _____

Property Owner (if not applicant): Gregg Shimanski
Street Address: 1603 Monroe Street **City/State:** Madison, WI **Zip:** 53711

4. **Project Information:**

Provide a brief description of the project and all proposed uses of the site: Demolition of two existing buildings & construction of a new, 61,400 gsf, 4 floor mixed-use building with 44 units & 5k sf of Commercial.

Development Schedule: Commencement April 2017 Completion May 2018

5. Required Submittal Information

All Land Use applications are required to include the following:

Project Plans including:*

- Site Plans (fully dimensioned plans depicting project details including all lot lines and property setbacks to buildings; demolished/proposed/altered buildings; parking stalls, driveways, sidewalks, location of existing/proposed signage; HVAC/Utility location and screening details; useable open space; and other physical improvements on a property)
- Grading and Utility Plans (existing and proposed)
- Landscape Plan (including planting schedule depicting species name and planting size)
- Building Elevation Drawings (fully dimensioned drawings for all building sides, labeling primary exterior materials)
- Floor Plans (fully dimensioned plans including interior wall and room location)

Provide collated project plan sets as follows:

- **Seven (7) copies** of a full-sized plan set drawn to a scale of 1 inch = 20 feet (folded or rolled and stapled)
- **Twenty Five (25) copies** of the plan set reduced to fit onto 11 X 17-inch paper (folded and stapled)
- **One (1) copy** of the plan set reduced to fit onto 8 ½ X 11-inch paper

* For projects requiring review by the **Urban Design Commission**, provide **Fourteen (14) additional 11x17 copies** of the plan set. In addition to the above information, all plan sets should also include: 1) Colored elevation drawings with shadow lines and a list of exterior building materials/colors; 2) Existing/proposed lighting with photometric plan & fixture cutsheet; and 3) Contextual site plan information including photographs and layout of adjacent buildings and structures. The applicant shall bring samples of exterior building materials and color scheme to the Urban Design Commission meeting.

Letter of Intent: Provide one (1) Copy per Plan Set describing this application in detail including, but not limited to:

- | | | |
|---|---|--|
| • Project Team | • Building Square Footage | • Value of Land |
| • Existing Conditions | • Number of Dwelling Units | • Estimated Project Cost |
| • Project Schedule | • Auto and Bike Parking Stalls | • Number of Construction & Full-Time Equivalent Jobs Created |
| • Proposed Uses (and ft ² of each) | • Lot Coverage & Usable Open Space Calculations | • Public Subsidy Requested |
| • Hours of Operation | | |

Filing Fee: Refer to the Land Use Application Instructions & Fee Schedule. Make checks payable to: *City Treasurer*.

Electronic Submittal: All applicants are required to submit copies of all items submitted in hard copy with their application as Adobe Acrobat PDF files on a non-returnable CD to be included with their application materials, or by e-mail to pcapplications@cityofmadison.com.

Additional Information may be required, depending on application. Refer to the Supplemental Submittal Requirements.

6. Applicant Declarations

Pre-application Notification: The Zoning Code requires that the applicant notify the district alder and any nearby neighborhood and business associations in writing no later than **30 days prior to FILING this request**. List the alderperson, neighborhood association(s), and business association(s) AND the dates you sent the notices:
Alder Sara Eskrich, Vilas Neighborhood Association, Demo List Serve - 12/18/16

→ If a waiver has been granted to this requirement, please attach any correspondence to this effect to this form.

Pre-application Meeting with Staff: Prior to preparation of this application, the applicant is required to discuss the proposed development and review process with Zoning and Planning Division staff; note staff persons and date.

Planning Staff: Kevin Firchow Date: 1/28/16 & 11/16/16 Zoning Staff: Matt Tucker Date: 1/28/16 & 11/16/16

The applicant attests that this form is accurately completed and all required materials are submitted:

Name of Applicant Paul Cuta

Relationship to Property: Architect

Authorizing Signature of Property Owner _____

Date (4/13/16) 11/21/16

Kevin Firchow
City of Madison– Department of Planning
Department of Planning and Economic Development
215 Martin Luther King Jr. Blvd., Suite LL100
Madison, WI 53703

4/13/16 11/21/16

Re Planning Commission Submittal – Letter of Intent
Sixteen O Three Monroe– A Gregg Shimanski Development

Dear Kevin and Committee Members,

Sixteen O Three Monroe

Action Requested

Major Alteration to Approved Demolition & Conditional Use.

Introduction

1603 Monroe Street is a new, mixed-use building proposed on the corner of Monroe Street and Oakland Street. The building combines the properties at 1603/1605 & 1609 Monroe Street and will require the complete demolition of the existing structures on the site. The existing buildings include a small, two story, dated office building with an adjacent parking structure and an older, two story, stick-frame house currently maintained as a rental property with student occupants. The originally proposed and approved design was comprised a 5 level mixed-use building over two levels of below grade parking with 44 rental residential units, 4 residential condominium units and first floor commercial space of approximately 5,000 square feet. The newly proposed, or revised building is a mixed-use building comprised of one level of structured parking, first floor commercial space, and 44 rental housing units on levels one through four. The parking level is partially exposed along Oakland Street and the Alley. Parking access is immediately off of Oakland Street and provides 16 public-use/shared-use parking stalls immediate upon entry. An additional 27 vehicle parking stalls and 46 bicycle spaces are provided for secured residential parking. The first floor commercial space fronts Monroe Street with a modulated, arcade that step together with the floor slab as the site drops from West to East to help improve the pedestrian experience and active zone as one moves along the face of the building. The residential entry is located along the West side of the building. This location mirrors residential access of the adjacent apartment building providing addition space to both entries and allowing for opportunities of social engagement. The building is articulated as a masonry structure with large vertical piers resulting in deep punched bays filled with expansive glass. This is indented to provide a strong feel of permanence while allowing significant natural light and visual modulation for tenants and the public. The modulation also provides depth to the elevation and in addition to breaking the overall mass into scaled proportions more commonly found along Monroe Street. A more significant vertical bay is located at the primary entry location, which is also intended to help terminate the view terminus from Breese Terrace. The commercial level is delineated by the expansive use of clear glazed store front capped with a recessive signage band and belt course of hook-strap metal panel. This same metal clad material forms a nested vertical mass evident along the Oakland

elevation that provides the mechanical screening at the roof, extending down the East facade becoming a metal ribbon that extends north to the corner and wraps it, extending a delineated datum along the Monroe Street façade. This belt course becomes a cantilevered plane that extends back along the West side of the site to provide covered entry to the residential entry as well as identifiable end wall of the entry porch. Above this form, the masonry mass is capped with a 4th level of gray composite lap siding that also captures the eroded masonry mass at the corner of Monroe and Oakland. This layered massing together with the significant glazing at the corner provides the four units occupying the corner and the overall building massing with an articulated and activated presence at this significant corner. The building mass is further eroded as one moves along Oakland Street and around the Alley elevation to reveal a stepped composition of masonry and lap siding that helps reduce the presence of the massing as it fronts the existing neighborhood to the South. The building massing is purposely stepped back along the length of the alley with an additional step-back along the Oakland, and extending west approximately 2/3 into the site to help mitigate the massing impact on the most immediate residential neighbors. The West side of the building also steps back from the West lot line, and above the first level, 10 feet to provide more space to the adjoining apartment building.

Zoning

The TSS zoning for this site allows for a zero lot line on all sides of the site including the alley and west side frontages. TSS zoning also allows more than three floors but only as a conditional use, which we are pursuing for both the area (exceeding 25,000 GSF) and height exceptions. The Monroe Street Commercial Plan, adopted by the City of Madison on March 27, 2007, identifies this block as in need of redevelopment and suggests heights of 3 to 4 floors with a step back. The authors of the Monroe Street Commercial Plan also recognized and anticipated that there will be unique sites and circumstances as development of the neighborhood progresses, noting specific to height and massing, “There are no absolutes; projects should be considered on a case-by-case basis with the general guidance that compatibility with the surroundings should be an emphasis in rendering approval decisions.” Further specifics of this Plan also address considerations related to building height including but not limited to considerations such as: Design, Contextual Impacts (i.e. the resulting public space), Proximity to other Building Forms (i.e. the monumental historic structure) and Important Compensatory Value Added Features (such as public-use parking in our instance). Given this information and after studying this site and surround area, we feel strongly that this site has unique characteristics and opportunity to help shape an underutilized civic space located immediately across the street. Given the various factors, including the urban open space, topography and nearby structures, including the monumental historic structure across the square/park, this site warrants a more significant frontage along Monroe Street to help hold the urban edge and better define the resulting public space. This site is also significant as an urban square that becomes the confluence of many things such as the three neighborhoods coming together with the major civic/educational institution in addition to the multi-modal crossroads that already exists here (bike paths, b-cycle, pedestrian and several bus routes). We feel there is great opportunity to vastly improve the park and square across the street from this site by shaping it into a true civic crossroads, gathering space and activity center. This can be further enhanced by the elimination of Crazy Legs Lane to make the park space whole, which is also supported

15002.00 – 1603 Monroe – Plan Comm. Letter of Intent

by the approved Monroe Street Commercial District Plan. We believe this space can become an activated and programmed urban plaza/park that is formed by the structures that help to shape the evolving fabric of our neighborhoods and City.

Project Team

Owner	Sixteen O Three, LLC	Gregg Shimanski
Architect	Cās4 Architecture, LLC	Paul Cuta
Contractor	Krupp	Paul Leinhart

Existing Conditions

See attached Photos

Proposed Uses

Commercial	5,353	Net Square Feet
Parking & Storage	16,053	Gross Square Feet
Residential & General Use	39,965	Gross Square Feet

Hours of Operation

Typical hours of operation are:

Commercial	7:30 am – 6:00 pm	Monday – Friday
Residential	24 / 7	

Building Square Footage

61,371 Gross Square Feet

Number of Dwelling Units

Forty Four (44)

- 18 – Studios
- 4 – Convertible/One Bedroom Units
- 10 – One Bedroom Units
- 12 - Two Bedroom Units

Auto & Bike Parking Stalls

Bicycle Parking	58
Moped Parking	0
Auto Parking (43 Total)	
Accessible	1
Van Accessible	2
Non-Accessible	40

15002.00 – 1603 Monroe – Plan Comm. Letter of Intent

Lot Coverage and Usable Open Space:

Lot Size 16,786 sf

Pervious Area:

Landscape 153 SF

Green Roof 2,578 SF

Total 2,731 SF

Proposed ISR 83.7%

Residential Balconies & Terraces 2,785 SF

Value of Land

\$700,000 - \$900,00

Estimated Project Cost

\$8,800,000 (\$7,000,000 construction cost)

Number of Construction & Full-Time Equivalent Jobs Created

Commercial Space 12 FTE's

Construction Jobs 15-30 FTE's

Public Subsidy Requested

None.

Paul M. Cuta, AIA

Partner

PMC/mds

Attachments:

Copied File



CITY OF MADISON FIRE DEPARTMENT

30 West Mifflin Street, 8th & 9th Floors, Madison, WI 53703-2579

Phone: 608-266-4420 • Fax: 608-267-1100 • E-mail: fire@cityofmadison.com

Project Address: 1603 MONROE ST.

Contact Name & Phone #: PAUL CUTZ, 608-345-1114

FIRE APPARATUS ACCESS AND FIRE HYDRANT WORKSHEET

1. Is the building completely protected by an NFPA 13 or 13R automatic fire sprinkler system? If non-sprinklered, fire lanes extend to within 150-feet of all portions of the exterior wall? If sprinklered, fire lanes are within 250-feet of all portions of the exterior wall?	<input checked="" type="checkbox"/> Yes <input type="checkbox"/> Yes <input checked="" type="checkbox"/> Yes	<input type="checkbox"/> No <input type="checkbox"/> No <input type="checkbox"/> No	<input type="checkbox"/> N/A <input type="checkbox"/> N/A <input type="checkbox"/> N/A
2. Is the fire lane constructed of concrete or asphalt, designed to support a minimum load of 85,000 lbs? a) Is the fire lane a minimum unobstructed width of at least 20-feet? b) Is the fire lane unobstructed with a vertical clearance of at least 13½-feet? c) Is the minimum inside turning radius of the fire lane at least 28-feet? d) Is the grade of the fire lane not more than a slope of 8%? e) Is the fire lane posted as fire lane? (Provide detail of signage.) f) Is a roll-able curb used as part of the fire lane? (Provide detail of curb.) g) Is part of a sidewalk used as part of the required fire lane? (Must support +85,000 lbs.)	<input checked="" type="checkbox"/> Yes <input checked="" type="checkbox"/> Yes <input checked="" type="checkbox"/> Yes <input checked="" type="checkbox"/> Yes <input type="checkbox"/> Yes <input type="checkbox"/> Yes <input type="checkbox"/> Yes	<input type="checkbox"/> No <input type="checkbox"/> No <input type="checkbox"/> No <input type="checkbox"/> No <input checked="" type="checkbox"/> No <input checked="" type="checkbox"/> No <input checked="" type="checkbox"/> No	<input type="checkbox"/> N/A <input type="checkbox"/> N/A <input type="checkbox"/> N/A <input type="checkbox"/> N/A <input type="checkbox"/> N/A <input type="checkbox"/> N/A <input type="checkbox"/> N/A
3. Is the fire lane obstructed by security gates or barricades? If yes: a) Is the gate a minimum of 20-feet clear opening? b) Is an approved means of emergency operations installed, key vault, padlock or key switch?	<input type="checkbox"/> Yes <input type="checkbox"/> Yes <input type="checkbox"/> Yes	<input checked="" type="checkbox"/> No <input type="checkbox"/> No <input type="checkbox"/> No	<input type="checkbox"/> N/A <input type="checkbox"/> N/A <input type="checkbox"/> N/A
4. Is the Fire lane dead-ended with a length greater than 150-feet? If yes, does the area for turning around fire apparatus comply with IFC D103?	<input type="checkbox"/> Yes <input type="checkbox"/> Yes	<input checked="" type="checkbox"/> No <input type="checkbox"/> No	<input type="checkbox"/> N/A <input type="checkbox"/> N/A
5. Is any portion of the building to be used for high-piled storage in accordance with IFC Chapter 3206.6 If yes, see IFC 3206.6 for further requirements.	<input type="checkbox"/> Yes	<input checked="" type="checkbox"/> No	<input type="checkbox"/> N/A
6. Is any part of the building greater than 30-feet above the grade plane? If yes, answer the following questions: a) Is the aerial apparatus fire lane parallel to one entire side of the building and covering at least 25% of the perimeter? b) Is the near edge of the aerial apparatus fire lane between 15' and 30' from the building? c) Are there any overhead power or utility lines located across the aerial apparatus fire lane? d) Are there any tree canopies expected to grow across the aerial fire lane? (Based on mature canopy width of tree species) e) Does the aerial apparatus fire lane have a minimum unobstructed width of 26-feet? f) Is the space between the aerial lane and the building free of trees exceeding 20' in heights?	<input checked="" type="checkbox"/> Yes <input checked="" type="checkbox"/> Yes <input checked="" type="checkbox"/> Yes <input type="checkbox"/> Yes <input checked="" type="checkbox"/> Yes <input checked="" type="checkbox"/> Yes	<input type="checkbox"/> No <input type="checkbox"/> No <input checked="" type="checkbox"/> No <input checked="" type="checkbox"/> No <input type="checkbox"/> No <input type="checkbox"/> No	<input type="checkbox"/> N/A <input type="checkbox"/> N/A <input type="checkbox"/> N/A <input type="checkbox"/> N/A <input type="checkbox"/> N/A <input type="checkbox"/> N/A
7. Are all portions of the required fire lanes within 500-feet of at least (2) hydrants? <i>Note: Distances shall be measured along the path of the hose lay as it comes off the fire apparatus.</i> a) Is the fire lane at least 26' wide for at least 20-feet on each side of the hydrants? b) Is there at least 40' between a hydrant and the building? c) Are the hydrant(s) setback no less than 5-feet nor more than 10-feet from the curb or edge of the street or fire lane? d) Are hydrants located in parking lot islands a minimum of 3½-feet from the hydrant to the curb? e) Are there no obstructions, including but not limited to: power poles, trees, bushes, fences, posts located, or grade changes exceeding 1½-feet, within 5-feet of a fire hydrant?	<input checked="" type="checkbox"/> Yes <input checked="" type="checkbox"/> Yes <input checked="" type="checkbox"/> Yes <input checked="" type="checkbox"/> Yes <input type="checkbox"/> Yes <input checked="" type="checkbox"/> Yes	<input type="checkbox"/> No <input type="checkbox"/> No <input type="checkbox"/> No <input type="checkbox"/> No <input checked="" type="checkbox"/> No <input type="checkbox"/> No	<input type="checkbox"/> N/A <input type="checkbox"/> N/A <input type="checkbox"/> N/A <input type="checkbox"/> N/A <input type="checkbox"/> N/A <input type="checkbox"/> N/A

Note: Hydrants shall be installed and in-service prior to combustible construction on the project site.

Attach an additional sheet if further explanation is required for any answers.

This worksheet is based on MGO 34.503 and IFC 2012 Edition Chapter 5 and Appendix D; please see the codes for further information.

DESCRIPTION

The Halo Surface LED Downlight (SLD) incorporates WaveStream™ technology to create an ultra-low profile surface mounting luminaire with the performance and look of a traditional downlight. SLD6 is designed for installation in many 3-1/2" and 4" square, octagon or round junction boxes. And may also retrofit in 5" and 6" IC and Non-IC recessed housings.* Suitable for residential or commercial installations. Ideal for closets, storage areas, attics and basements. Compliant with NFPA® 70, NEC® Section 410.16 (A)(3) and 410.16 (C)(5).

Catalog #		Type
Project		
Comments		Date
Prepared by		

SPECIFICATION FEATURES

CONSTRUCTION

- Die cast aluminum trim ring, and die formed aluminum frame

OPTICS

- WaveStream™ technology provides uniform luminance from a low profile flat lens
- AccuAim™ optics provide directional control for the "cone-of-light" beam distribution of a traditional downlight.
- Precision molded lens features high transmission polymer with UV stabilized protecting film

DESIGNER TRIMS

Accessories (sold separately)

SLD designer trims are accessory rings that attach to the SLD for a permanent finish. Refer to SLD accessories specification sheet for details.

- White (Paintable)
- Satin Nickel
- Tuscan Bronze

ELECTRICAL JUNCTION BOX MOUNTING

- SLD may be used in compatible electrical junction boxes in direct contact with insulation including spray foam insulation
- Suitable for installation in many 3-1/2" and 4" square, octagon, and round electrical junction boxes

Note: Driver consumes 3 cubic inches of junction box

- Surface mounting in a fire-rated ceiling using an appropriate electrical box offers a cost-effective alternative to fire-rated recessed housings

Note: Fire-rating is per the rating of the ceiling and applicable junction box, not the SLD.

- Installer must ensure compatibility of fit, wiring and proper mounting in the electrical junction box. This

includes all applicable national and local electrical and building codes

- Proprietary Slot-N-Lock quick installation system for junction box installation
- T-bracket with Slot-N-Lock mounting tabs included

RECESSED HOUSING MOUNTING

- May be installed in IC recessed housings in direct contact with insulation

*** Note:** Not for use in recessed housings in direct contact with spray foam insulation. Refer to NEMA LSD 57-2013

Torsion Spring 5" & 6"

- Optional precision formed torsion spring bracket kit is included
- The torsion springs adjust on the frame to fit 5" or 6" compatible housings

Friction Blade 5" & 6"

- Optional precision formed friction blades included
- For retrofit in 5" and 6" housings without torsion spring mounting tabs
- Friction blade design allows the SLD to be installed in any position within the housing aperture (360 degrees)

LED

- Trilateral linear LED assembly is integrated in trim perimeter
- Color Temperature: 2700K, 3000K, 3500K, 4000K
- CRI options: 80 and 90
 - 90 CRI can be used for California Title 24 compliance/certified to Title 20
 - 80 CRI can be used to comply with California Title 24 Non-Residential Lighting Controls as a LED luminaire.
- L70 at 50,000 hours projected in accordance with TM-21

WARRANTY

Cooper Lighting provides a five year limited warranty on the SLD LED

LED CHROMATICITY

- A tight chromaticity specification ensures LED color uniformity, sustainable Color Rendering Index (CRI) and Correlated Color Temperature (CCT) over the useful life of the LED
- LED chromaticity of 3 SDCM exceeds ENERGY STAR® color standards per ANSI.
- 90 CRI model features high color performance with R9 greater than 50

- Every Halo LED is quality tested, measured, and serialized in a permanent record to register lumens, wattage, CRI and CCT.
- Halo LED serialized testing and measurement ensures color and lumen consistency on a per-unit basis, and validates long-term product consistency over time

ELECTRICAL CONNECTIONS Junction Box

- Compatible with 3-1/2" x 2" and 4" x 1-1/2" deep round, square and octagon boxes (2-1/8" deep boxes recommended)
- Supply Wire Adapter with LED quick connector included

Recessed Housings

- LED connector is compatible with Halo 5" H550 Series and 6" H750 Series LED Housings
- LED Connector meets California Title-24 high-efficacy luminaire standard as a non-screw base
- The included E26 Edison screw-base adapter provides capability for retrofit
- LED connector is a non-screwbase luminaire disconnect for tool-less installation

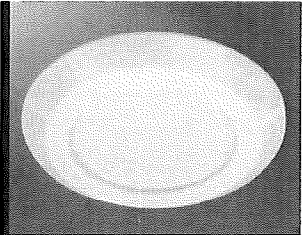

SLD 600 Series

SLD6068xxWH

80CRI
2700K, 3000K, 3500K, and 4000K

SLD6069xxWH

90CRI
2700K, 3000K, 3500K, and 4000K

6" Surface LED Downlight

Suitable for ceiling or wall electrical junction boxes

Suitable for 5" & 6" recessed housing retrofit (IC, Non-IC & AIR-TITE™)

ENERGY DATA

	80 CRI	90 CRI
Lumens (4000K models)	800	780
Input Voltage	120V	120V
Frequency	50/60 Hz	50/60 Hz
Input Current	0.10 A	0.11 A
Input Power	12.2 W	13.2 W
Efficiency (4000K models)	66 lm/W	59 lm/W
THD	≤ 20%	
Power Factor	≥ 0.90	
T Ambient	-30 - +40°C	
Sound Rating	Class A	

NOMENCLATURE

SLD606 8 30 WH
606 = 6" SLD 600 Series
8 = >80 CRI
30 = 3000K
WH = Matte White

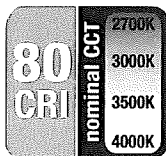

Refer to ENERGY STAR® Certified Products List. Can be used to comply with California Title 24 Non-Residential Lighting Controls requirements as a LED Luminaire.

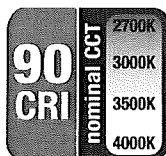

Refer to ENERGY STAR® Certified Products List. Can be used to comply with California Title 24 High Efficacy requirements. Certified to California Title 20 Appliance Efficiency Database.

LED DRIVER

- Driver is a 120V input, high efficiency, dimmable electronic power supply providing DC power to the LED array
- Driver features high power factor, low THD, and has integral thermal protection in the event of over temperature or internal failure
- Driver is replaceable if it should be required

DIMMING

- Designed for continuous dimming capability to nominally 5% with many 120V Leading Edge (LE) and Trailing Edge (TE) phase control dimmers. Dimming to 5% is best assured using dimmers with low end trim adjustment. Consult dimmer manufacturer for compatibility and conditions of use. (Note some dimmers require a neutral in the wallbox.)

COMPLIANCE

- cULus Listed ceiling and wall
- cULus Damp Location listed ceiling and wall
- cULus Wet Location Listed, ceiling only (shower rated)
- Suitable for use in closets, compliant with NFPA® 70, NEC® Section 410.16 (A)(3) and 410.16 (C)(5)
- SLD may be used in compatible electrical junction boxes in direct contact with insulation including spray foam insulation
- May be installed in IC recessed housings in direct contact with insulation (Not for use in recessed housings in direct contact with spray foam insulation. Refer to NEMA LSD 57-2013)
- UL Classified when used in retrofit with listed housings (See Housing Compatibility)
- EMI/RFI: meets FCC 47CFR Part 15 Class B limits, and is suitable for use in residential and commercial installations
- Airtight certified per ASTM E283 (not exceeding 2.0 CFM under 57 Pascals pressure difference)
- 90 CRI: Can be used to comply with California Title 24 High Efficacy requirements. Certified to California Title 20 Appliance Efficiency Database.
- 80 CRI: Can be used to comply with California Title 24 Non-Residential Lighting Controls requirements as a LED luminaire.
- Can be used for International Energy Conservation Code (IECC) and Washington State Energy Code high efficiency luminaire compliance
- ENERGY STAR® certified luminaire - consult ENERGY STAR® Certified Product List
- Contains no mercury or lead and RoHS compliant.
- Photometric testing in accordance with IES LM-79
- Lumen maintenance projections in accordance with IES LM-80 and TM-21

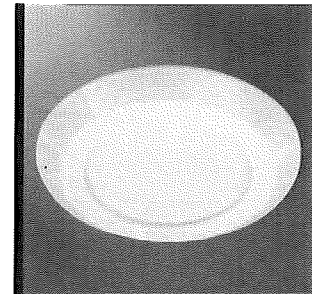

SLD 600 Series

SLD6068xxWH

80CRI
2700K, 3000K, 3500K,
and 4000K

SLD6069xxWH

90CRI
2700K, 3000K, 3500K,
and 4000K

6" Surface LED Downlight

Suitable for ceiling or wall electrical junction boxes

Suitable for 5" & 6" recessed housing retrofit (IC, Non-IC & AIR-TITE™)

DIMENSIONS

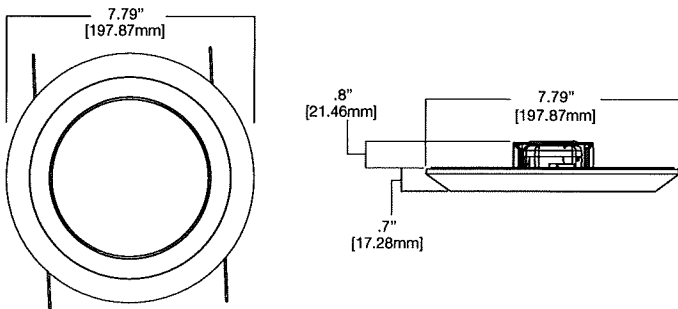

ORDERING INFORMATION

SAMPLE NUMBER: SLD606927WH SLD6TRMSN

Junction Box Installation: Order junction box separately, as supplied by others, to complete installation.

Recessed Installation: Order Halo recessed housing separately to complete installation.

Models	Color Rendering Index	Color Temperature (CCT)	Finish	Accessories
SLD606= 6" Surface LED Downlight, 120V 600 Series	8=80 CRI 9=90 CRI	27=2700K 30=3000K 35=3500K 40=4000K	WH=White	<p>Designer Trims Fit over the SLD for a designer finish SLD6TRMSN=6" SLD Satin Nickel SLD6TRMTBZ=6" SLD Tuscan Bronze SLD6TRMWH=6" SLD White (paintable)</p> <p>J-Box Spacer Extension Ring Add 15/16" depth when SLD driver cannot fit into installed junction box SLD6EXT=6" Surface LED J-Box Extender, 9.5" O.D.</p> <p>RAD Adapters When junction box is mounted flat on a ceiling or beam surface (not recessed in ceiling) SLD6RAD=6" SLD Round Surface J-Box Adapter, 7.92" O.D. (for 4-inch round or octagon junction boxes.) SLD6SADPLT=6" SLD Square Surface J-Box Adapter Plate (For 4-inch square junction boxes, use with SLD6RAD.)</p> <p>Spare Parts SLD6ACCKIT=6" Accessory Parts Replacement Kit (Screwbase adapter, torsion springs, friction blades) SLD6BRKT=6" Junction Box Bracket & Screws</p> <p>Refer to SLD Accessories specification sheet for further information.</p>



Excellence in Illumination Engineering Software
since 1984



sample banner copyright 2013 Lighting Analysts, Inc.

C1

Photometric Report (Type C)

Filename: C1_HALO_SLD606835WH.ies
[TEST] P166799 TEST IS SCALED FROM IESNA LM-79-08 TEST
DATA (P14660)
[TESTLAB] INNOVATIONS CENTER-P1
[ISSUE DATE] 3/31/2015
[MANUFAC] EATON - HALO (FORMER COOPER LIGHTING)
[LUMCAT] SLD606835WH
[LUMINAIRE] HALO 6 INCH SURFACE LED DOWNLIGHT
[LAMP] LED 80CRI / 3500K CCT

Maximum Candela = 266.3 at 0 H 20 V

Classification:

Road Classification: Type V, Very Short, N.A. (deprecated)
Upward Waste Light Ratio: 0.00
Luminaire Efficacy Rating (LER): 64
Indoor Classification: Direct
BUG Rating : B1-U0-G0

LCS Summary:

LCS Zone	Lumens	%Lamp	%Lum
FL (0-30)	110.1	N.A.	14.1
FM (30-60)	213.5	N.A.	27.4
FH (60-80)	59.1	N.A.	7.6
FVH (80-90)	7.3	N.A.	0.9
BL (0-30)	110.1	N.A.	14.1
BM (30-60)	213.5	N.A.	27.4
BH (60-80)	59.1	N.A.	7.6
BVH (80-90)	7.3	N.A.	0.9
UL (90-100)	0.0	N.A.	0.0
UH (100-180)	0.0	N.A.	0.0
Total	780.0	N.A.	100.0
BUG Rating	B1-U0-G0		

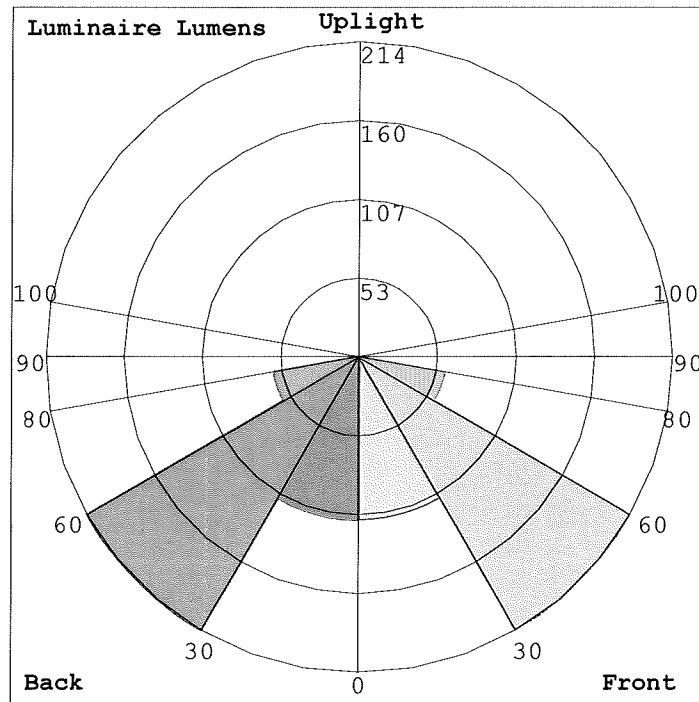

HALO LED ICAT HOUSING for NEW CONSTRUCTION

The H750ICAT is a dedicated LED new construction housing to be used with designated HALO LED modules. The H750ICAT is designed for insulated ceilings and can be in direct contact with ceiling insulation*. This AIRTITE housing design prevents airflow between conditioned and unconditioned spaces and saves on both heating and air conditioning costs. The LED connector system provides high efficacy code compliance when used with designated HALO LED modules and trims.

DL6

HALO®

Catalog #		Type
Project		
Comments		Date
Prepared by		

DESIGN FEATURES

Housings

Aluminum construction for greater heat dissipation. H750 ICAT housing is gasketed to prevent airflow from heated or air conditioned spaces.

Plaster Frame

Galvanized steel frame. Housing adjusts in plaster frame to accommodate up to 1" ceiling thickness. Regressed locking screw for securing hanger bars. Cutouts included for easily crimping hanger bars in position

Slide-N-Side™ Junction Box

- Positioned to accommodate straight conduit runs.
- Seven 1/2" trade size conduit knockouts with true pry-out slots.
- Slide-N-Side wire traps allow non metallic sheathed cable to be installed without tools and without removing knockouts.
- Allows wiring connections to be made outside the box.
- Simply insert the cable directly into the trap after connections are made.
- Accommodates the following standard non-metallic sheathed cable type:
 - U.S. #14/2, #14/3, #12/2, #12/3
 - Canada: #14/2, #14/3, #12/2

GOT NAIL! Pass -N-Thru™ Bar Hangers

Bar Hanger features include

- Pre-installed nail easily installs in regular lumber, engineered lumber and laminated beams.
- Safety and Guidance system prevents snagging, ensures smooth, straight nail penetration and allows bar hangers to be easily removed if necessary
- Automatic leveling flange aligns the housing and allows holding the housing in place with one hand while driving nails.
- Housing can be positioned at any point within 24" joist spans
- Score lines allow tool-free shortening for 12" joists and bar hangers do not need to be removed for shortening.
- Bar hangers may be repositioned 90° on plaster frame
- Integral T-bar clip snaps onto T-bars – no additional clips are required.

LED Module Connection

Halo LED modules simply install with a plug-in 120V-277V rated line voltage wiring connector (UL and CSA Listed Luminaire Disconnect). This non-screw-base connection preserves the high efficacy rating and prevents use of low efficacy incandescent sources (see LED Module specifications).

Caution

Connection is rated for 120V and 277V input. Installer must verify LED module voltage is compatible with the applicable voltage input. If uncertain, consult a qualified electrician.

Labels

- UL/cUL Listed 1598 Luminaire
- CE Marking - "Conformité Européenne" conformity with the Council of European Communities Directives, meeting internationally recognized compliance when used with ML56 Series LED modules
- UL/cUL Listed for Feed Through
- UL/cUL Listed for Damp Location
- UL/cUL Listed for Wet Location with select trims
- UL/cUL Listed for direct contact with insulation and combustible material*
- Rated for 20W maximum

Qualification

May be used with qualified Halo LED modules and designated trims for High Efficacy Luminaire Compliance:

- State of California Title 24
- International Energy Conservation Code (IECC)
- Washington State Energy Code
- New York State Energy Conservation Construction Code - AIR-TITE™ Compliant
- Certified under ASTM-E283 standard for air-tight construction

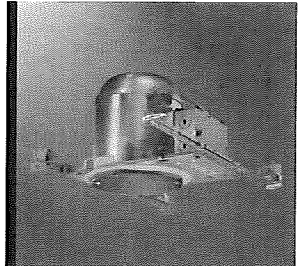
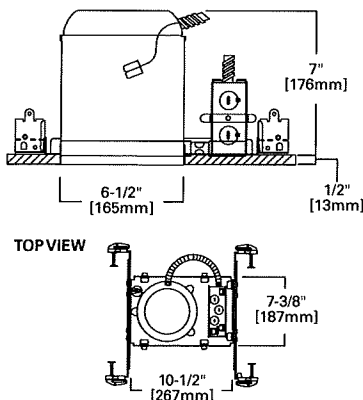

H750ICAT

6" New Construction IC AIR-TITE™ Housing For Halo LED Modules and Trims

- ML56 Series
- RL56 Series
- RA56 Series

High Efficacy LED Housing

FOR USE IN INSULATED CEILINGS

FOR DIRECT CONTACT WITH INSULATION*



Qualified and compliant with select trims. Refer to ENERGY STAR® Qualified Products List and CEC (T24) Appliance Database for listings.

Description

The Halo ML56 LED Downlighting System is a series of modular LED Light Modules for use with designated 5" or 6" ML56 LED trims in new construction, remodel and retrofit installation. Compatible with Halo 5" H550 and 6" H750, H2750 Series LED housings. And in retrofit of existing housings the ML56 Series fits 5" or 6" Halo, All-Pro, and others. ML56 system offers shallow trims for installation in Halo, All-Pro and others shallow housings. ML56 Light Modules are offered in 600 Series, 900 Series, and 1200 Series, 80CRI or 90CRI, and four color temperatures 2700K, 3000K, 3500K, 4000K. ML56 Light Modules are universal voltage 120V – 277V and dimmable at 120V. The ML56 lens provides uniform diffuse illumination standard.

Catalog #		Type
Project		
Comments		Date
Prepared by		

Specification Features

Mechanical

Light Module

- Module includes LED package, LED driver, heat sink, and lens
- Durable die-cast aluminum construction.
- Heat sink designed to conduct heat away from the LED keeping the junction temperatures below specified maximums, including insulated ceiling environments

Lens

- Impact-resistant polycarbonate
- Convex form for lamp-like appearance
- High lumen transmission
- Diffusing for even illumination

Mounting

- Light Modules attach to reflector and baffle trims via locking tabs, and attach to eyeballs via keyed twist-to-lock mating bosses
- The complete light module and trim assembly installs into housings with precision formed torsion springs located on the trim
- Friction Blade mounting is an alternate option using the accessory 6" Friction Blade Kit model ML56CLIP (order separately). Friction blades provide alternative to torsion springs for retrofit in 6" housings without torsion mounting tabs. The stainless steel friction blades allow the ML56 to be installed in a wider range of housings, and allow rotation in the housing aperture (360 degrees).

Housing Compatibility

A complete ML56 system includes a LED Light Module, LED trim, and a compatible housing (new construction, remodel, or existing retrofit). Housing compatibility in the ML56 System is determined by the ML56 trim dimensions. ML56 trims are available in 5" and 6" aperture (5" = 59xx series and 6" = 69xx series trims). Refer to Housing – Trim Section in this document.

LED

- 900 Series = 900 design lumens typical.
- Delivered lumens vary depending upon 5" or 6", color temperature, and trim finish.
- Color Temperature options: 2700K, 3000K, 3500K, 4000K

- CRI: 80
- L70 at 50,000 hours, projected in accordance with IES TM-21
- LED is a chip on board design consisting of a multiple LED package to create one virtual light source for a productive "cone of light"

Color Specification & Quality Standards

- A tight chromaticity specification ensures LED color uniformity, sustainable Color Rendering Index (CRI) and Correlated Color Temperature (CCT) over the useful life of the LED
- LED color uniformity of 3 SDCM exceeds ENERGY STAR® color standards per ANSI C78.377-2008.
- Every Halo LED Light Module is quality tested and performance measured, and then serialized in a permanent record to register lumens, wattage, CRI and CCT.
- Halo LED serialized testing and measurement process ensures color and lumen consistency on a per-unit basis, and validates long-term product consistency over time
- Halo ML56 LED Light Modules include lumen, CRI, and CCT designations in the model number
- Example: **ML5609830**
56 = 5" / 6" aperture series
09 = 900 lumen series
8 = >80 CRI
30 = 3000K nominal CCT

Electrical Power Connections

- LED connector is a non-screw base luminaire disconnect offering easy installation with the matching Halo 5" H550 series and 6" H750 and H2750 series housings (housing selected depends upon LED trim 5" or 6").
- LED Connector is a non-screw base, and where required to qualify as a high-efficacy luminaire.
- The included E26 medium screw-base Edison adapter provides easy retrofit of incandescent housings (see Housing Section).

Ground Connection

Separate grounding cable included on the module for attachment to the housing during installation.

LED Driver

- Driver is universal voltage 120V-277V, and may be controlled from a switch in this range of main inputs (switchable at 120V, 220V, 230V, 240V, and 277V)
- Driver is dimmable at 120V operation when connected to a compatible dimmer.
- Driver is a high efficiency, electronic power supply providing DC power to the LED.
- Driver meets FCC EMI/RFI Consumer Level limits on 120V main inputs, and is compliant for use in residential and commercial installations.
- Driver features high power factor, low THD, and has integral thermal protection in the event of over temperature or internal failure.
- Driver is replaceable, if replacement should be required.

Dimming

Designed for dimming capability to nominal 5% in normal operation with standard 120V Leading Edge (LE) and Trailing Edge (TE) phase control dimmers. (Consult dimmer manufacturer for dimmer compatibility and details. Note, some dimmers require a neutral in the wallbox.)

Warranty

Cooper Lighting provides a (5) five year limited warranty on the Halo ML56 LED Light Module.

LED Module in New or Retrofit Existing Construction – Housings other than Halo or All-Pro

- If used in recessed housings other than Halo or All-Pro the Cooper Lighting 5-year limited warranty applies to the LED Light Module and Trim only.
- As with any electrical installation, a qualified electrician must ensure compatibility of use with a particular housing; this includes all applicable national and local electrical and building codes. Installer is responsible to properly and securely retain the LED Module and LED Trim in the housing at time of installation.

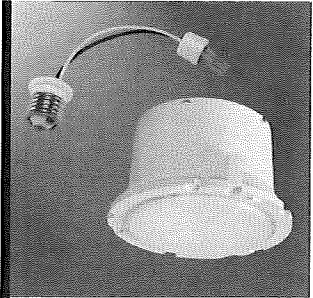

ML56 LED System

900 Series / 80 CRI

ML5609827

ML5609830

ML5609835

ML5609840

**5-Inch and 6-Inch
900 Lumen LED**

**Light Module for
New Construction,
Remodel and Retrofit**

**For use with 59x and 69x
Series Trims**

**FOR USE IN
INSULATED CEILING
AND NON-INSULATED
CEILING RATED
HOUSINGS**

**HIGH EFFICACY LED
WITH INTEGRAL
DRIVER - DIMMABLE**

Energy Data

ML56 900/80 Series

(Values at non-dimming line voltage)

Minimum Starting Temp: -30°C (-22°F)

EMI/RFI: FCC Title 47 CFR, Part 15, (Consumer)

Sound Rating: Class A

Input Voltage: UNV 120V-277V

Power Factor: >0.95 @ 120V and >0.9 @277V

Input Frequency: 50/60Hz

THD: <20%

Max. Rated Wattage: 14W

Input Power: 13.4W

Input Current at 120V: 0.15A

Input Current at 277V: 0.08A

Driver Compliance: UL8750, Class II rated

Maximum IC (Insulated Ceiling) Ambient
Continuous Operating Temperature: 25°C (77°F)

Maximum Non-IC Ambient Continuous
Operating Temperature: 40°C (104°F)



ML5609827
5" or 6" LED 900 Series

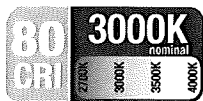

ML5609830
5" or 6" LED 900 Series



ML5609835
5" or 6" LED 900 Series



ML5609840
5" or 6" LED 900 Series

Cooper Lighting

by **E.T.N.**

ADV141692
3/02/2015

Compliance

- cULus listed 1598 Luminaire (Halo and All-Pro housings)
- UL Classified when used in retrofit (refer to housing section)
- cULus listed for damp locations
- cULus Wet location listed with baffle and reflector trims only
- Airtight certified per ASTM E283 (not exceeding 2.0 CFM under 57 Pascals pressure difference)
- IP66 ingress protection rated with baffle and reflector trims only
- RoHS compliant
- May be used in IC (insulated ceiling) housings in direct contact with insulation* and combustible material
- Can be used as a California Title 24 compliant Non-Residential LED Luminaire
- Can be used for International Energy Conservation Code (IECC) high efficiency luminaire compliance.
- Can be used for Washington State Energy Code compliance
- ENERGY STAR® certified luminaire - consult ENERGY STAR® Certified product list
- EMI/RFI per FCC 47CFR Part 15 Class B Consumer limits (commercial and residential compliant)
- Photometric testing in accordance with IES LM-79
- Lumen maintenance projections in accordance with IES LM-80 and TM-21
- CE Mark - "Conformité Européene" conformity with the Council of European Communities Directives, meeting internationally recognized compliance when used with Halo H550, H750, and H2750 Series LED housings only

* Not for use with housings in direct contact with spray foam insulation.



Refer to ENERGY STAR® Certified Products List.
 Can be used to comply with California Title 24 Non-Residential Lighting Controls requirements as a LED Luminaire

Dimensions

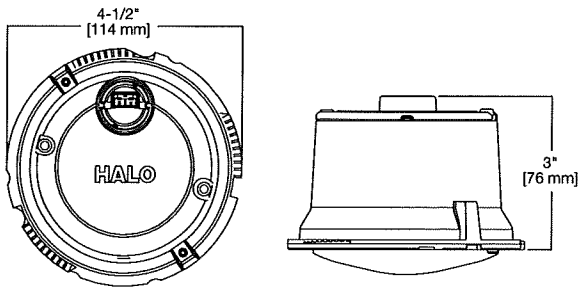

Ordering Information

Sample Number: **ML5609830 593WB**

Order LED Module and trim separately.

A complete system also includes a compatible housing (new construction, remodel, or existing retrofit). Housing aperture size in the ML56 System is determined by the ML56 trim dimensions. ML56 trims are available in 5" and 6" aperture (5" = 59xx series and 6" = 69xx series trims). Refer to Housing Section in this document.

**ML56 LED Light Modules
900 Series / 80 CRI**

ML5609827= 5"/6" LED light module, 900 lumen, 80CRI, 2700K

ML5609830= 5"/6" LED light module, 900 lumen, 80CRI, 3000K

ML5609835= 5"/6" LED light module, 900 lumen, 80CRI, 3500K

ML5609840= 5"/6" LED light module, 900 lumen, 80CRI, 4000K

ML56 LED 5" and 6" Trims

590 Series - 5" LED Trims

591WB=5" LED trim, polymer "dead-front", shallow white baffle & flange – shallow and standard housings (For use with 600 Series LED light modules only)

592SC=5" LED trim, specular reflector & white flange

592H=5" LED trim, haze reflector & white flange

592W=5" LED trim, white reflector & flange

593WB=5" LED trim, white micro-step baffle & flange

593BB=5" LED trim, black micro-step baffle & white flange

593SNB=5" LED trim, satin nickel micro-step baffle & flange

593TBZB=5" LED trim, tuscan bronze micro-step baffle & flange

594WB=5" LED directional trim, white eyeball, baffle & flange – shallow and standard housings

594SNB=5" LED directional trim, satin nickel eyeball, baffle & flange – shallow and standard housings

594TBZB=5" LED directional trim, tuscan bronze eyeball, baffle & flange – shallow and standard housings

595WW=5" LED trim, wall wash - specular reflector, repositionable specular kick reflector, white flange

596WB=5" LED trim, white shallow baffle & flange – shallow and standard housings

690 Series - 6" LED Trims

691WB=6" LED trim, polymer "dead-front", white shallow baffle & flange – shallow and standard housings (For use with 600 Series LED light modules only)

692SC=6" LED trim, specular reflector & white flange

692H=6" LED trim, haze reflector & white flange

692W=6" LED trim, white reflector & flange

693WB=6" LED trim, white micro-step baffle & flange

693BB=6" LED trim, black micro-step baffle & white flange

693SNB=6" LED trim, satin nickel micro-step baffle & flange

693TBZB=6" LED trim, tuscan bronze micro-step baffle & flange

694WB=6" LED directional trim, white eyeball, baffle & flange – shallow and standard housings

694SNB=6" LED directional trim, satin nickel eyeball, baffle & flange – shallow and standard housings

694TBZB=6" LED directional trim, tuscan bronze eyeball, baffle & flange – shallow and standard housings

695WW=6" LED trim, wall wash - specular reflector, repositionable specular kick reflector, white flange

696WB=6" LED trim, white shallow baffle & flange – for use with shallow and standard housings

ML56 System Accessories

ML56CLIP=Friction clip mounting kit - for retrofitting non-torsion spring housings, 6" clips*

WW595SC=5" Wall wash insert - kick reflector for 595WW (1-included with trim) double or corner wall wash**

WW695SC=6" Wall wash insert - kick reflector for 695WW (1-included with trim) double or corner wall wash**

TRM590WH=5" LED oversize trim ring for use with 59" series trims, white 6.3" I.D., 7.5" O.D. Ring slips over LED trim. Inset design allows 5" trim to fit into oversize ring for an even trim surface

TRM690WH=6" LED oversize trim ring for use with 69" series trims, white 6.9" I.D., 9.5" O.D. Ring slips over LED trim. Inset design allows 6" trim to fit into oversize ring for an even trim surface

*ML56CLIP is compatible with 6" baffle and reflector trims only (691, 692, 693, 695, 696 series).

For eyeball trim (694 series) use ML7RAB retrofit adapter band.

**Wall Wash Trims 595WW and 695WW Feature an exclusive Repositionable Kick Reflector for fine-tuning adjustment of the wall wash effect. The WW595SC and WW695SC are Repositionable Kick Reflectors sold separately for addition to the Wall Wash Trim when a double or corner wall wash is needed, or for replacement of original kick reflector included with the trim.

Lighting Facts

ML5609827

PRODUCT SPECIFICATIONS	
Lumens (Light Output)	934
Watts	13.4
Lumens Per Watt (Efficacy)	69.7
Color Accuracy (CRI)	81
Light Color (CCT)	2700K
<small>Correlated Color Temperature (CCT)</small>	
<small>MODEL ML5609827</small>	

ML5609830

PRODUCT SPECIFICATIONS	
Lumens (Light Output)	1009
Watts	13.4
Lumens Per Watt (Efficacy)	75.3
Color Accuracy (CRI)	82
Light Color (CCT)	3000K
<small>Correlated Color Temperature (CCT)</small>	
<small>MODEL ML5609830</small>	

ML5609835

PRODUCT SPECIFICATIONS	
Lumens (Light Output)	1024
Watts	13.4
Lumens Per Watt (Efficacy)	76.4
Color Accuracy (CRI)	83
Light Color (CCT)	3500K
<small>Correlated Color Temperature (CCT)</small>	
<small>MODEL ML5609835</small>	

ML5609840

PRODUCT SPECIFICATIONS	
Lumens (Light Output)	1045
Watts	13.4
Lumens Per Watt (Efficacy)	78.0
Color Accuracy (CRI)	82
Light Color (CCT)	4000K
<small>Correlated Color Temperature (CCT)</small>	
<small>MODEL ML5609840</small>	

DESCRIPTION

692 Series LED Trims - 6-inch Aperture Reflectors - are integral elements in the Halo ML56 LED Downlighting System. ML56 LED System is a series of modular LED Light Modules for use with dedicated 5" or 6" ML56 LED trims. The ML56 LED trims in 5" and 6" aperture sizes are designed to fit Halo, All-Pro and others 5" or 6" recessed housings. The ML56 system is suitable for new construction, remodel or retrofit installation.

Catalog #		Type
Project		
Comments		Date
Prepared by		

SPECIFICATION FEATURES

692 Series LED trims are 6-inch aperture reflectors offered in Specular Clear, Haze (Semi-Specular Clear), and White (Matte White). 692 Series Reflectors also feature matte white finish flange. The precision spun aluminum reflector provides excellent optical performance. The 692 reflectors may be used in most standard height 6-inch aperture recessed housings; Halo, All-Pro, and more (refer to ML56 LED Light Module specifications for details).

- For use with ML56 Series LED light modules
- For use in standard housings
- Reflectors with self-flange
- Wet location shower listed with ML56 LED Light Modules
- Torsion springs pull trim and light module tight to ceiling
- ML56 downlight trims and modules make any housing AIR-TITE™ (ASTM E283)

Compatible with ML56 LED System of LED Downlight Light Modules**600 Series - 80CRI, 600lm****5" / 6" LED Retrofit Downlight Engine**

ML5606827 - 2700K
ML5606830 - 3000K
ML5606835 - 3500K
ML5606840 - 4000K

600 Series - 90CRI, 600lm**5" / 6" LED Retrofit Downlight Engine**

ML5606927 - 2700K
ML5606930 - 3000K
ML5606935 - 3500K
ML5606940 - 4000K

900 Series - 80CRI, 900lm**5" / 6" LED Retrofit Downlight Engine**

ML5609827 - 2700K
ML5609830 - 3000K
ML5609835 - 3500K
ML5609840 - 4000K

900 Series - 90CRI, 900lm**5" / 6" LED Retrofit Downlight Engine**

ML5609927 - 2700K
ML5609930 - 3000K
ML5609935 - 3500K
ML5609940 - 4000K

1200 Series - 80CRI, 1200lm**5" / 6" LED Retrofit Downlight Engine**

ML5612827 - 2700K
ML5612830 - 3000K
ML5612835 - 3500K
ML5612840 - 4000K

1200 Series - 90CRI, 1200lm**5" / 6" LED Retrofit Downlight Engine**

ML5612927 - 2700K
ML5612930 - 3000K
ML5612935 - 3500K
ML5612940 - 4000K

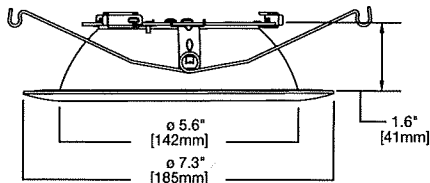
**ORDERING INFORMATION**

SAMPLE NUMBER: 692SC

Trim	Finish	Accessory
692= 6" Reflector	SC=Specular Clear, White Flange H=Haze (Semi-Specular), White Flange W=White (Matte White), White Flange	TRM690WH= 6" LED Oversize Trim Ring for use with 69" series trims, White 6.9" I.D., 9.5" O.D. Ring slips over LED trim. Inset design allows 6" trim to fit into oversize ring for an even trim surface ML56CLIP= Friction Clip Mounting Kit - For retrofitting non-torsion spring housings, 6" clips

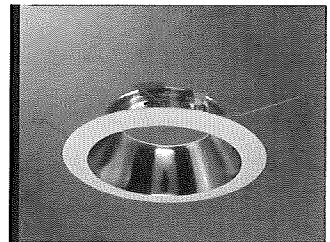
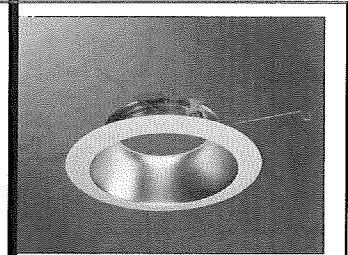
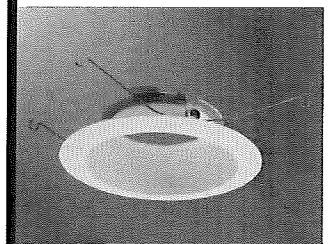
**692SC****692H****692W****692 Series LED Trim****6-Inch Reflector**

For use with
Halo ML56
LED System
Light Modules





Excellence in Illumination Engineering Software
since 1984



sample banner copyright 2013 Lighting Analysts, Inc.

DL6

Photometric Report (Type C)

Filename: DL6_ML5606835-692H.ies
[TEST] P130309 TEST IS SCALED FROM IESNA LM-79-08 TEST
DATA (P24956)
[TESTLAB] Innovations Center P2
[ISSUEDATE] 11/10/2014
[MANUFAC] EATON - HALO (FORMER COOPER LIGHTING)
[LUMCAT] ML5606835-692H
[LUMINAIRE] HALO 6 INCH ML56 LED DOWNLIGHT WITH HAZE
REFLECTOR
[LAMP] (1) HIGH LUMEN LED 80CRI / 3500K CCT

Maximum Candela = 641.3 at 0 H 0 V

Classification:

Road Classification: Type V, Very Short, N.A. (deprecated)
Upward Waste Light Ratio: 0.00
Luminaire Efficacy Rating (LER): 80
Indoor Classification: Direct
BUG Rating : B1-U0-G0

LCS Summary:

LCS Zone	Lumens	%Lamp	%Lum
FL (0-30)	188.9	N.A.	26.2
FM (30-60)	167.4	N.A.	23.2
FH (60-80)	4.8	N.A.	0.7
FVH (80-90)	0.0	N.A.	0.0
BL (0-30)	188.9	N.A.	26.2
BM (30-60)	167.4	N.A.	23.2
BH (60-80)	4.8	N.A.	0.7
BVH (80-90)	0.0	N.A.	0.0
UL (90-100)	0.0	N.A.	0.0
UH (100-180)	0.0	N.A.	0.0
Total	722.2	N.A.	100.0
BUG Rating	B1-U0-G0		

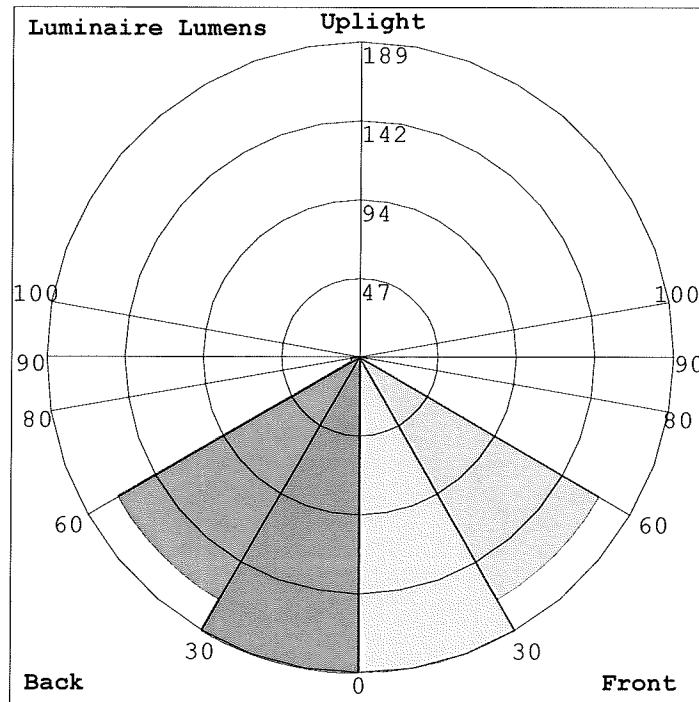

DESCRIPTION

The Vaportite LED Series is an energy efficient industrial Vaportite fixture that features rugged and durable construction. The Vaportite LED incorporates a full metal fixture liner inside a reinforced fiberglass housing with a high impact diffuser. This Vaportite series is suitable for interior and exterior applications and can be surface or chain mounted.

The Vaportite LED Series has been designed for maximum operation in commercial institutional and industrial environments and can operate in a wide range of temperatures (-20°C to 25°C) and is ideal for cold storage environments.

SPECIFICATION FEATURES

Construction

Fiberglass housing is reinforced polyester and self-extinguishing (ASTM-D635-74) plastic of a permanent pearl gray color. A watertite hub for 1/2" conduit entry is provided at each end of housing (standard) for continuous feed. Polyurethane gasketing is formed in the housing providing a continuous seamless seal for the diffuser. Four sturdy cam latches clamp diffuser tightly for a positive seal between housing, gasketing and diffuser. Electrical components and fixtures are UL cUL listed for Wet Locations.

Electrical

Long-Life LED system coupled with electrical driver to deliver optimal performance. LED's available in 3500, 4000 and 5000K with a CRI ≥ 85. Projected life is 60,000 hours at 91% lumen output. cULus listed. Electronic drivers are available for 120-277V applications. A 0-10V dimming control is available (standard). IP65 rated and NSF certified (4' only).

Lens

DR=Internal Prismatic Lens/15% DR High Impact Additive.
DR100=Internal Prismatic Lens/100% DR High Impact Additive.

Warranty

Vaportite LED features a five year limited warranty.

Compliance

DesignLights Consortium™ Qualified and classified for DLC Standard (some models are not DLC qualified), refer to www.designlights.org for details.

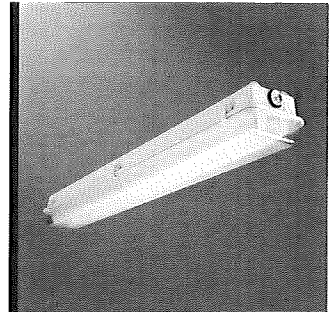
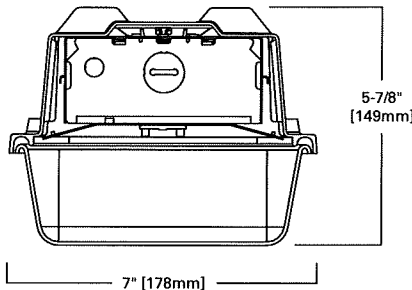

VAPORTITE LED

4' INDUSTRIAL LED LAMP

Vaportite Industrial Refrigerated Case



MOUNTING DATA

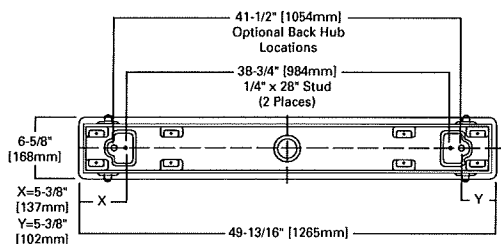

INSTALLATION DATA

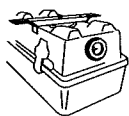

MOUNTING BRACKETS
Furnished
Two per 2' and 4' Unit
Four per 8' Unit

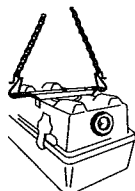

OPTIONAL CHAN HANGING SET
(VT2-CHAIN/SETU)
Includes 6 ft. of chain, 4 large S-Hooks and 4 small S-Hooks
Order One (1) Kit for each 2' or 4' Fixture

ENERGY DATA

Input Watts:
4VT2-LD4-4 (4,000 lumens)=38W
4VT2-LD4-6 (6,000 lumens)=57.3W
4VT2-LD4-8 (8,000 lumens)=81.1W

PHOTOMETRICS

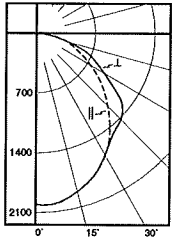

4VT2-LD4-6-DR-UNV-L835-CD1-U

Electronic Driver
 Linear LED 3500K
 Spacing criterion:
 (H) 1.2 x mounting
 height, (L) 1.2 x
 mounting height
 Lumens: 5882
 Input Watts: 56W
 Efficacy: 104.7 lm/W
 Test Report:
 4VT2-LD4-6-DR-
 UNV-L835-CD1-U.
 IES

Candlepower

Angle	Along H	45°	Across L
0	2000	2000	2000
5	2007	1979	1980
10	1981	1951	1956
15	1930	1900	1903
20	1857	1836	1844
25	1764	1748	1765
30	1645	1646	1660
35	1511	1522	1534
40	1375	1393	1468
45	1221	1271	1438
50	1062	1207	1343
55	903	1175	1148
60	749	1048	933
65	600	1151	771
70	461	591	600
75	332	398	426
80	206	249	255
85	94	137	127
90	34	75	63

Coefficients of Utilization

rc rw RCR	Effective floor cavity reflectance 20%																				
	80%				70%				50%				30%				10%				0%
	70	50	30	10	70	50	30	10	50	30	10	50	30	10	50	30	10	50	30	10	0
0	119	119	119	119	116	116	116	116	110	110	110	105	105	105	101	101	101	99			
1	108	103	98	94	105	101	96	93	96	93	90	92	89	87	88	86	84	82			
2	98	89	82	76	95	87	81	75	84	78	73	80	75	71	77	73	70	67			
3	89	78	70	63	86	76	69	62	73	67	61	70	65	60	68	63	59	56			
4	81	69	60	53	79	68	59	53	65	58	52	62	56	51	60	55	50	48			
5	75	62	52	46	73	60	52	45	58	51	45	56	49	44	54	48	44	41			
6	69	55	46	40	67	54	46	40	52	45	39	51	44	39	49	43	38	36			
7	64	50	41	35	62	49	41	35	48	40	35	46	39	34	45	38	34	32			
8	59	46	37	31	58	45	37	31	44	36	31	42	35	31	41	35	30	28			
9	56	42	34	28	54	41	33	28	40	33	28	39	32	28	38	32	27	25			
10	52	39	31	25	51	38	31	25	37	30	25	36	30	25	35	29	25	23			

Zonal Lumen Summary

Zone	Lumens	% Fixture
0-30	1536	26.1
0-40	2490	42.3
0-60	4463	75.9
0-90	5804	98.7
0-180	5882	100.0

LUMEN MAINTENANCE

Ambient Temperature	TM-21 Lumen Maintenance (60,000 hours)	Theoretical L70 (Hours)
25°C	> 91%	> 247,000

ORDERING INFORMATION

SAMPLE NUMBER: 4VT2-LD4-4-DR-UNV-L840-CD1-WL-U

<p>Series⁽¹⁾ 4VT2=4' Vaportite</p>	<p>Distribution [Blank]=Medium (Standard) W=Wide Distribution</p>	<p>Lamps L835=3500K, LED L840=4000K, LED L850=5000K, LED</p>	<p>WL=Wet Location Label</p>	<p>Options SSL=Stainless Steel Latches TH=(2) Top Watertite Hubs TEH=(2) Top and (2) End Watertite Hubs (all Watertite Hubs have 1/2" Conduit Entry)</p>	<p>Packaging U=Unit Pack</p>
<p>Lamp Type LD4=LED 4.0</p>	<p>Voltage UNV=Universal Voltage 120-277</p>	<p>Driver Type CD1=1 Dimming Driver 5LTD1=5th Light DALI</p>			
<p>LED Lumens Output 4=4000 Lumens 6=6000 Lumens 8=8000 Lumens</p>	<p>Remote Emergency Enclosure VT-REM-EL=Emergency Installed, 700 lumens⁽²⁾</p>				
<p>Lens DR=Internal Prismatic Lens/15% DR High Impact Additive DR100=Internal Prismatic Lens/100% DR High Impact Additive FR50=Frosted Lens/15% DR High Impact Additive⁽¹⁾</p>				<p>Accessories (order separately) VT2-Chain/Set-U=Chain Hanging Set Includes 6 ft. of chain, 4 large S-Hooks and 4 small S-Hooks Order One (1) Kit for each 2' or 4' Fixture VT2-SS-MBK=Stainless Steel Mounting Bracket</p>	

NOTES: ⁽¹⁾ Not available in wide distribution. ⁽²⁾ DesignLights Consortium™ Qualified and classified for DLC Standard (some models are not DLC qualified), refer to www.designlights.org for details. ⁽³⁾ EL must specify 120 or 277V only.

Specifications & dimensions subject to change without notice. Consult your Eaton Representative for availability and ordering information.

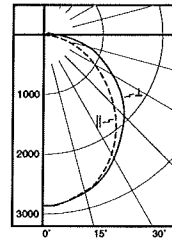

4VT2-LD4-8-FR50-UNV-L835-CD1-WL-U

Electronic Driver
 Linear LED 3500K
 Spacing criterion:
 (H) 1.2 x mounting
 height, (L) 1.3 x
 mounting height
 Lumens: 8553
 Input Watts: 81W
 Efficacy: 105.5 lm/W
 Test Report:
 4VT2-LD4-8-FR50-
 UNV-L835-CD1-WL-
 U.IES

Candlepower

Angle	Along H	45°	Across L
0	2854	2854	2854
5	2857	2829	2842
10	2811	2790	2804
15	2733	2723	2742
20	2626	2629	2658
25	2484	2508	2545
30	2316	2365	2408
35	2120	2195	2253
40	1904	2011	2086
45	1678	1819	1914
50	1451	1622	1736
55	1222	1422	1558
60	1009	1229	1368
65	810	1034	1171
70	622	843	959
75	446	659	748
80	287	487	555
85	148	341	392
90	45	228	271

Coefficients of Utilization

rc rw RCR	Effective floor cavity reflectance 20%																				
	80%				70%				50%				30%				10%				0%
	70	50	30	10	70	50	30	10	50	30	10	50	30	10	50	30	10	50	30	10	0
0	118	118	118	118	115	115	115	115	109	109	109	104	104	104	99	99	99	96			
1	107	102	97	93	104	99	95	91	94	91	87	90	87	84	85	83	81	79			
2	97	88	81	75	94	86	79	74	82	76	72	78	73	69	74	71	67	65			
3	88	77	69	62	85	75	68	61	72	65	60	69	63	58	66	61	57	54			
4	81	68	59	53	78	67	58	52	64	57	51	61	55	50	59	53	49	46			
5	74	61	52	45	72	60	51	45	57	50	44	55	48	43	53	47	42	40			
6	69	55	46	39	66	54	45	39	52	44	38	50	43	38	48	42	37	35			
7	64	50	41	35	62	49	41	35	47	40	34	46	39	34	44	38	33	31			
8	59	46	37	31	57	45	37	31	43	36	30	42	35	30	40	34	30	28			
9	55	42	34	28	54	41	33	28	40	32	27	38	32	27	37	31	27	25			
10	52	39	31	25	50	38	30	25	37	30	25	36	29	25	34	29	24	23			

Zonal Lumen Summary

Zone	Lumens	% Fixture
0-30	2200	25.7
0-40	3573	41.8
0-60	6232	96.4
0-90	8248	100.0
0-180	8553	100.0



Eaton
 1121 Highway 74 South
 Peachtree City, GA 30269
 P: 770-486-4800
 www.eaton.com/lighting

Specifications and dimensions subject to change without notice.



Excellence in Illumination Engineering Software
since 1984



www.agi32.com

sample banner copyright 2013 Lighting Analysts, Inc.

PG

Photometric Report (Type C)

Filename: PG_Metalux_4VT2-LD4-4-DR-UNV-L840-CD1-U.ies
[TEST] P131682
[TESTLAB] INNOVATIONS CENTER-P3
[ISSUEDATE] 11/13/14
[MANUFAC] EATON - METALUX (FORMER COOPER LIGHTING)
[LUMCAT] 4VT2-LD4-4-DR-UNV-L840-CD1-U
[LUMINAIRE] METALUX 4' INDUSTRIAL VAPOR LIGHT WITH
CLEAR CREPE LENS. TEST IS SCALED FROM IESNA LM-79-08
TEST DATA (P33622)

Maximum Candela = 1553.9 at 0 H 2.5 V

Classification:

Road Classification: Type VS, Very Short, N.A. (deprecated)
Upward Waste Light Ratio: 0.01
Luminaire Efficacy Rating (LER): 119
Indoor Classification: Direct
BUG Rating : B2-U2-G1

LCS Summary:

LCS Zone	Lumens	%Lamp	%Lum
FL (0-30)	591.2	N.A.	13.1
FM (30-60)	1127.2	N.A.	24.9
FH (60-80)	456.0	N.A.	10.1
FVH (80-90)	60.2	N.A.	1.3
BL (0-30)	591.2	N.A.	13.1
BM (30-60)	1127.2	N.A.	24.9
BH (60-80)	456.0	N.A.	10.1
BVH (80-90)	60.2	N.A.	1.3
UL (90-100)	40.6	N.A.	0.9
UH (100-180)	19.3	N.A.	0.4
Total	4529.1	N.A.	100.0
BUG Rating	B2-U2-G1		

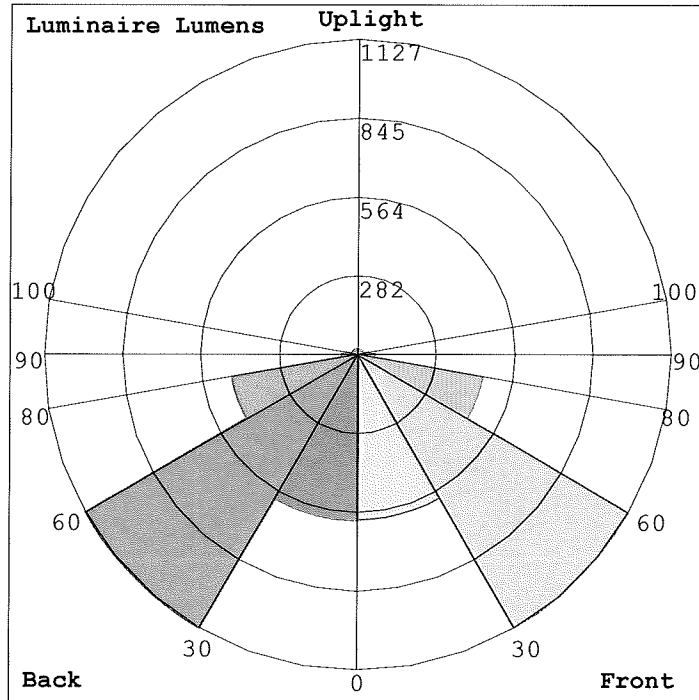



Date:

Type:

SL1

Fixture:

Project:

Approved:

FCSL550 Series

Exterior Die-Cast Mini Step Light with Die-Cast or 316 Stainless Steel Faceplate.

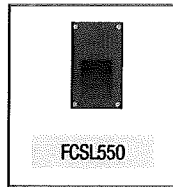

FCSL550



FCSL552



FCSL553

ORDERING



75 pcs or Less / ships in 2 weeks

EXAMPLE: FCSL550-120V-4K-95-SL

SERIES	VOLTAGE	SOURCE/TEMPERATURE/LAMP	FINISH	ACCESSORIES
FCSL550	120V	LED 3K 95 Lumens min (2W)	BK Black	EC E-Coat (on SL550 only)
FCSL552	277V	4K 190 Lumens min (3W)	BZ Bronze	
FCSL553	347V Δ		CC Custom Color	
			SL Silver	
			WH White	
			SS Stainless Steel \blacktriangle	

Δ contact factory

\blacktriangle SL552 & SL553 only

SPECIFICATION

MOUNTING

- Concrete pour standard.

CONSTRUCTION

- Marine grade, corrosion resistant, heavy walled, high pressure die-cast aluminum construction.
- Clear (FCSL550) or opal, tempered lens.
- 316 stainless steel (FCSL552, FCSL553 - opal lens standard).
- Precision formed semi-specular aluminum reflector.
- Neoprene continuous closed cell urethane 'O' ring gasket. Captive stainless steel, tamper resistant hex socket screws.

LED

- Lumens stated are the minimum delivered out of the luminaire. LED lifetime is greater than or equal to 70,000 hours with the lumen depreciation greater than L70. All of our luminaires are tested to LM 80 with a minimum CRI of 80 and color consistency of step 4 MacAdam Ellipse. Integral power supply standard. Input voltage 120V or 277V. Consult factory for non-white static color LED options; Red, Green, Blue or Amber.

FINISH

- Six stage chemical pre-treatment process that includes iron phosphate, to prepare the substrate for a UV stable, super durable standard polyester powder coat. Optional e-coat process is added to the standard finish including zinc phosphate for a 5 year limited warranty on the finish. Brushed 316 stainless steel faceplate (FCSL552, FCSL553 only).

ELECTRICAL

- Ballast** UL listed electronic driver standard with 5 year manufacturers warranty.

LISTING

- UL & cUL listed for interior and exterior wet locations. IP65 rating.

FC Lighting, Inc. reserves the right to change details or specifications without notice. Product use certifies agreement to FC Lighting's terms and conditions.



PHOTOMETRY

FCSL550

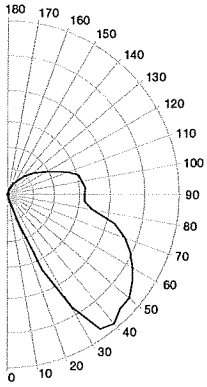

PVC - DIMENSIONS

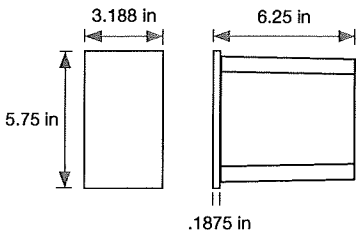

PVC Outer Housing

DIMENSIONS

FCSL550

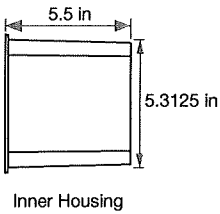
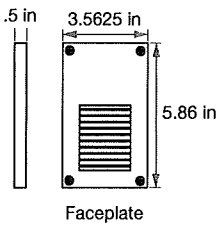

FCSL552

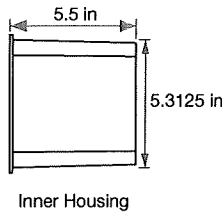
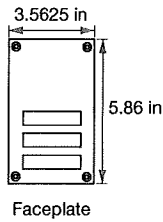

FCSL553

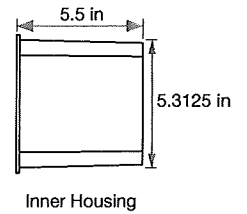
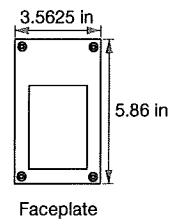



Excellence in Illumination Engineering Software
since 1984



sample banner copyright 2013 Lighting Analysts, Inc.

SL1

Photometric Report (Type C)

Filename: SL1_FCSSL550-LED.IES
[ISSUEDATE] 6-5-2009
[MANUFAC] FC LIGHTING
[LUMCAT] FCSSL550 LED-5W
[LUMINAIRE] FCSSL550 STEP LIGHT

Maximum Candela = 81.647998175025 at 0 H 45 V

Classification:

Road Classification: Type II, Very Short, Cutoff (deprecated)
Upward Waste Light Ratio: 0.01
Luminaire Efficacy Rating (LER): 7
Indoor Classification: Direct
BUG Rating : B0-U1-G0

LCS Summary:

LCS Zone	Lumens	%Lamp	%Lum
FL (0-30)	5.7	2.4	12.9
FM (30-60)	29.0	12.1	65.3
FH (60-80)	8.4	3.5	18.9
FVH (80-90)	0.7	0.3	1.7
BL (0-30)	< 0.05	0.0	0.0
BM (30-60)	< 0.05	0.0	0.0
BH (60-80)	< 0.05	0.0	0.0
BVH (80-90)	< 0.05	0.0	0.0
UL (90-100)	0.2	0.1	0.4
UH (100-180)	0.4	0.2	0.8
Total	44.4	18.6	100.0
BUG Rating	B0-U1-G0		

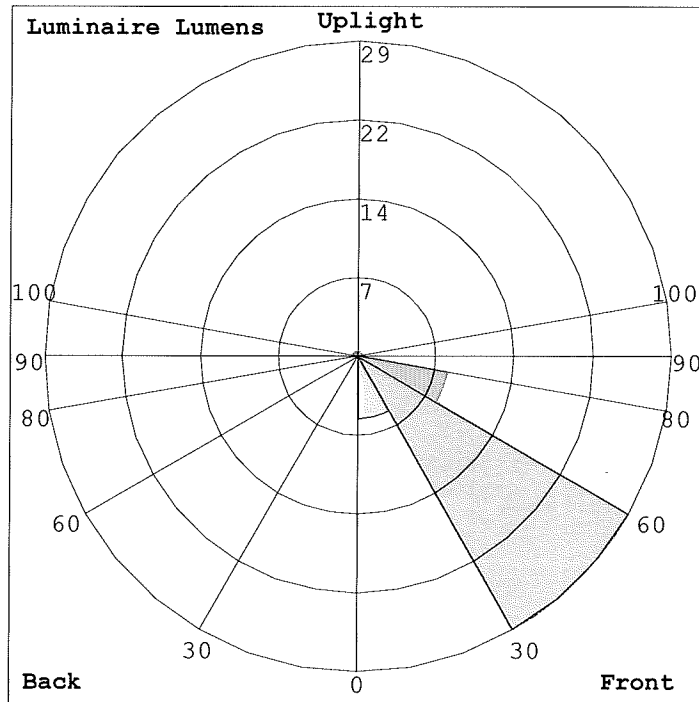

JOB NAME _____

Type _____

CATALOG NUMBER _____

Steplites

SL2

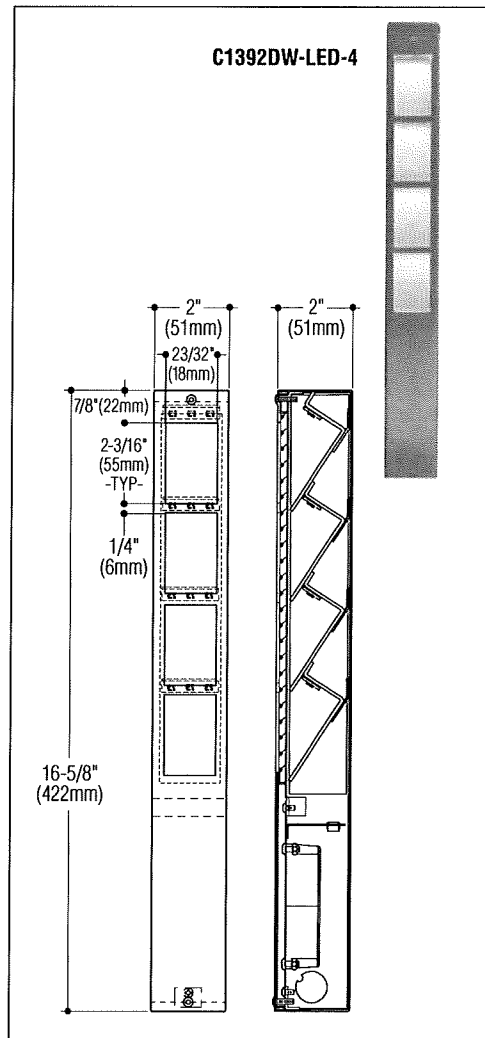
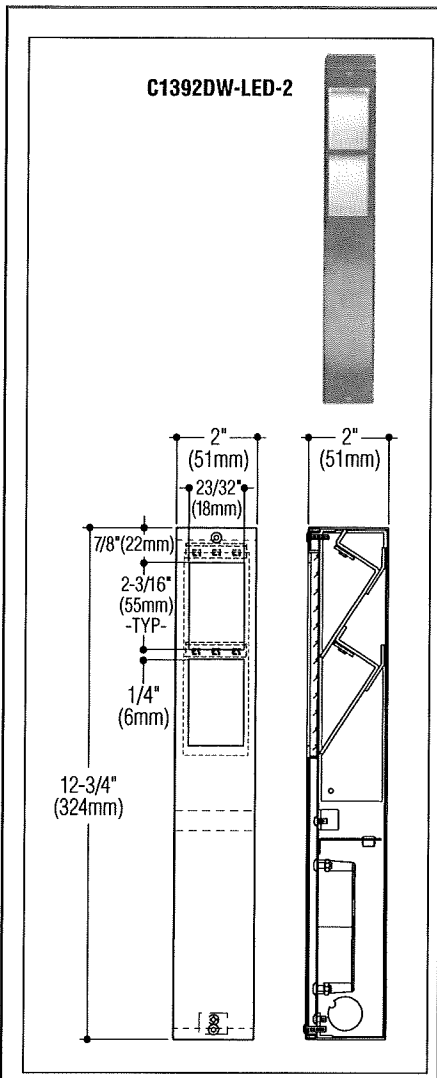

C1392D SERIES Railite

SPECIFICATIONS

Construction

- Housing is constructed from 20 gauge stainless steel or .050" aluminum • Satin finish with passivation on exterior stainless steel surfaces or powder coat on aluminum surfaces
- Diffuser is 1/8" clear tempered glass • Tamperproof screws provided • cETLus listed for use in wet locations, in any wall construction
- Intended for mounting between pairs of vertical support posts via field-drilled mounting holes. Other mounting methods are available on request.

Electrical

- Fixture is wired for high performance LEDs • Driver is universal voltage • Provided with 1/2" knockout on either side

Mounting

Intended for mounting between pairs of vertical support posts via field-drilled mounting holes. Other mounting methods are available on request.

How to Specify

Select catalog number and add suffix(s) for desired options.

Catalog Number Lamp

- LED 1.5W, (126 lm @ 3000°K)
- LED 3.6W, (215 lm @ 3000°K)
- LED 3.0W, (252 lm @ 3000°K)
- LED 7.2W, (430 lm @ 3000°K)

- C1392DW-LED-2
- C1392DW-LED-2-HO
- C1392DW-LED-4
- C1392DW-LED-4-HO

Housing W & D

- 2" x 2"
- 2" x 2"
- 2" x 2"
- 2" x 2"

Housing Length

- 12 3/4"
- 12 3/4"
- 16 5/8"
- 16 5/8"

*OPTIONAL 1/2" KO'S AT BOTTOM

- 1
- 1
- 1
- 1

*Optional 1/2" KO's at bottom assumes standard locknuts and side by side spacing

Options

Alternate housing dimensions:

Add suffix -SP/ _____ (dimensions).

Alternate shielding: Contact factory for options.

Add suffix -OS.

Painted finish: Add suffix -CC/ _____ (color).

Frosted glass diffuser: Tempered. Add suffix -FG

LED color: 4000°. Add suffix -4K

Tamperproof screws: Socket head faceplate screws.

Add suffix -TP

Bottom knockout: 1/2" knockout at bottom in lieu of standard side knockouts (3" wide housing suitable for two knockouts). Add suffix -BKO



C.W. Cole & Company, Inc.
2560 N. Rosemead Boulevard
South El Monte, CA 91733-1593

Tel. (626) 443-2473
Fax (626) 443-9253
info@colelighting.com
www.colelighting.com



Excellence in Illumination Engineering Software
since 1984



sample banner copyright 2013 Lighting Analysts, Inc.

SL2

Photometric Report (Type C)

Filename: SL2_COLE 1392D_L11136307.IES
[TEST] L11136307
[TESTLAB] LIGHT LABORATORY, INC.
[ISSUEDATE] 12/05/2013
[MANUFAC] C.W. COLE & CO., INC.
[LUMCAT] C1392D-LED-2
[LUMINAIRE] 12-3/4"L. X 2"W. X 2"H. LED FIXTURE CLEAR
LENS
[LAMPCAT] N/A
[BALLAST] INPUT: 100-277VAC, 50/60HZ, 0.15A OUTPUT:
12VDC, 250-1000mA

Maximum Candela = 33.04 at 0 H 45 V

Classification:

Road Classification: Type IV, Very Short, N.A. (deprecated)
Upward Waste Light Ratio: 0.00
Luminaire Efficacy Rating (LER): 10
Indoor Classification: Direct
BUG Rating : B0-U0-G0

LCS Summary:

LCS Zone	Lumens	%Lamp	%Lum
FL (0-30)	3.8	N.A.	14.6
FM (30-60)	16.6	N.A.	63.3
FH (60-80)	5.3	N.A.	20.0
FVH (80-90)	0.0	N.A.	0.0
BL (0-30)	0.2	N.A.	0.8
BM (30-60)	0.2	N.A.	0.8
BH (60-80)	0.1	N.A.	0.5
BVH (80-90)	0.0	N.A.	0.0
UL (90-100)	0.0	N.A.	0.0
UH (100-180)	0.0	N.A.	0.0
Total	26.2	N.A.	100.0
BUG Rating	B0-U0-G0		

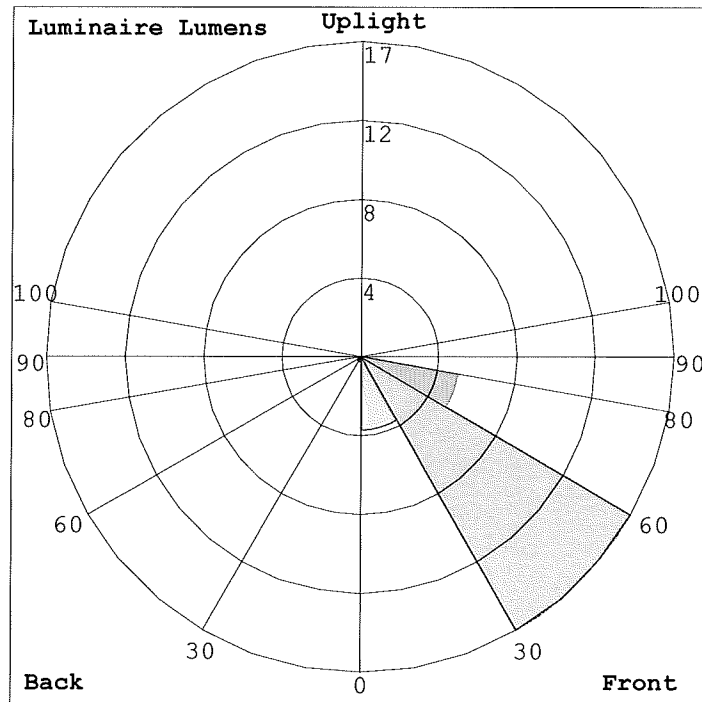

DESCRIPTION

Westwood 904 and 904-2 are small dimmable LED or MR16 low-voltage halogen luminaires. Model 904 provides downlight or uplight by way of its 180° rotational fixture head. Model 904-2 provides combination uplight and downlight. A square shroud option (-SQS) is available in both models, offering rectilinear styling instead of cylindrical. Both models mount directly to any wall surface or over a standard 4-inch J-box and require a remote 12-volt step-down transformer (not included). Various lenses, louvers, and color or dichroic filters can be combined - up to three at once - to create multiple lighting effects.

Catalog #		Type
Project		
Comments		Date
Prepared by		

SPECIFICATION FEATURES**A ... Material**

Housing and hood are precision-machined from corrosion-resistant 6061-T6 aluminum billet, brass, bronze or stainless steel. Mounting canopy is constructed from corrosion-resistant silicone aluminum, brass, bronze or stainless steel.

B ... Finish Painted

Fixtures constructed from 6061-T6 aluminum are double protected by an ROHS compliant chemical film undercoating and polyester powdercoat paint finish, surpassing the rigorous demands of the outdoor environment. A variety of standard colors are available. Brass, Bronze or Stainless Steel Fixtures constructed from brass, bronze or stainless steel are left unpainted to reveal the natural beauty of the material. Brass and bronze will patina naturally over time.

C ... Hood

Hood is removable for easy relamping and accepts up to three internal accessories at once (lenses, louvers, filters) to achieve multiple lighting effects. Weep holes prevent water collection on the uplight position.

D ... Gasket

Housing and hood are sealed with a high temperature silicone o-ring gasket to prevent water intrusion.

E ... Lens

Tempered glass lens, factory sealed with high temperature adhesive to prevent water intrusion and breakage due to thermal shock.

F ... Mounting

Both models mount directly to wall surface or over a standard 4" J-box and require remote 12V step-down transformer (not included). Model 904 provides downlight or uplight. Model 904-2 provides non-adjustable uplight and downlight. Lumière's exclusive Siphon Protection System (S.P.S.) prevents water from siphoning into the fixture through its own lead wires.

G ... Hardware

Stainless steel hardware is standard to provide maximum corrosion-resistance.

H ... Socket

Ceramic socket with 250° C Teflon® coated lead wires and GU5.3 bi-pin base.

I ... Electrical

Remote 12V transformer required (not included). NOTE: initial power draw on LED equipped fixtures is 15 watts. When sizing transformer use 15 watts per LED fixture. Nominal power draw after start up is 10 or 6 watts accordingly. Also, LEDs are more voltage sensitive than standard halogen MR16 lamps. The LED module is designed to operate between 10 and 13 volts. Any less or more voltage can cause premature failures.

J ... Lamp

Halogen lamp not included. Available from Lumière as an accessory - see reverse side for details and catalog logic. LED modules are included and are available in four color temperatures (2700,3000,4000, and 5700) and three distributions (spot, narrow, and flood). Both color temperature and distribution must be specified when ordering - see reverse side for details and catalog logic.

K ... Labels & Approvals

UL and cUL listed, standard wet label. IP65 rated. Manufactured to ISO 9001-2000 Quality Systems Standard. IBEW union made.

L ... Warranty

Lumière warrants its fixtures against defects in materials & workmanship for three (3) years. Auxiliary equipment such as transformers, ballasts and lamps carry the original manufacturer's warranty.

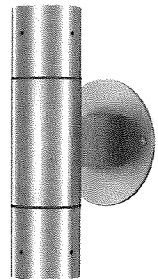
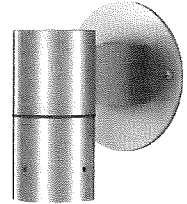
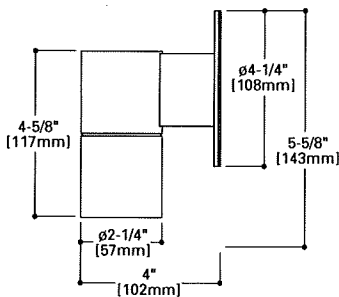
**WESTWOOD****904****904-2****10W LED****6W LED****50W (max.) MR16****Low Voltage****Wall****IP65**

Westwood 904

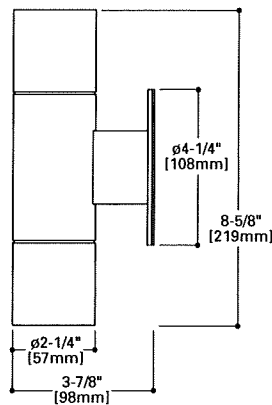

Westwood 904-2

PHOTOMETRIC DATA

WESTWOOD 904 / 904-2

Westwood 904/904-2
Lamp=50MR16/NSP
(EXT)
CBCP=11,000

Distance to Illuminated Plane	Initial Nadir Footcandles	Beam Diameter
15'0"	45	4'0"
10'0"	102	3'0"
8'0"	159	2'0"
6'0"	283	1'6"
4'0"	638	1'0"
2'0"	2550	0'6"

Lamp Wattage Multiplier
20W x 0.32



Westwood 904/904-2
Lamp=50MR16/WFL
(EXZ)
CBCP=3200

Distance to Illuminated Plane	Initial Nadir Footcandles	Beam Diameter
15'0"	13	10'0"
10'0"	29	6'6"
8'0"	45	5'0"
6'0"	81	4'0"
4'0"	181	2'6"
2'0"	725	1'0"



Westwood 904/904-2
Lamp=50MR16/FL
(EXN)
CBCP=2000

Distance to Illuminated Plane	Initial Nadir Footcandles	Beam Diameter
15'0"	7	12'0"
10'0"	17	8'0"
8'0"	27	6'6"
6'0"	48	5'0"
4'0"	106	3'0"
2'0"	431	1'6"

Lamp Wattage Multiplier
35W x 0.57
20W x 0.30



Westwood 904/904-2
Lamp=50MR16/WFL
(FNV)
CBCP=1200

Distance to Illuminated Plane	Initial Nadir Footcandles	Beam Diameter
15'0"	5	17'0"
10'0"	11	11'6"
8'0"	17	9'0"
6'0"	30	7'0"
4'0"	67	4'6"
2'0"	269	2'0"



ORDERING INFORMATION



Series
904=LED or MR16 Westwood Up/Down Wall Fixture Single Head, Round
904-2=MR16 Westwood Up/Down Wall Fixture - Dual Head, Round
904-UD=LED or MR16 Westwood Up/Down Wall Fixture - Dual Head, Round
904-SQ=LED or MR16 Westwood Up/Down Wall Fixture-Single Head, Square
904-SQ-UD=LED or MR16 Westwood Up/Down Wall Fixture - Dual Head, Square

Source
50MR16=50W Max Halogen MR16, GU5.3 Base
6LED2712=6W 2700K, 12 Degree Spot, GU5.3 Base
6LED2721=6W 2700K, 21 Degree Narrow, GU5.3 Base
6LED2741=6W 2700K, 41 Degree Wide, GU5.3 Base
6LED3012=6W 3000K, 12 Degree Spot, GU5.3 Base
6LED3021=6W 3000K, 21 Degree Narrow, GU5.3 Base
6LED3041=6W 3000K, 41 Degree Wide, GU5.3 Base
6LED4012=6W 4000K, 12 Degree Spot, GU5.3 Base
6LED4021=6W 4000K, 21 Degree Narrow, GU5.3 Base
6LED4041=6W 4000K, 41 Degree Wide, GU5.3 Base
6LED5712=6W 5700K, 12 Degree Spot, GU6.3 Base
6LED5721=6W 5700K, 21 Degree Narrow, GU5.3 Base
6LED5741=6W 5700K, 41 Degree Wide, GU5.3 Base
10LED2712= 10W 2700K, 12 Degree Spot, GU5.3 Base
10LED2721= 10W 2700K, 21 Degree Narrow, GU5.3 Base
10LED2741= 10W 2700K, 41 Degree Wide, GU5.3 Base
10LED3012= 10W 3000K, 12 Degree Spot, GU5.3 Base
10LED3021= 10W 3000K, 21 Degree Narrow, GU5.3 Base
10LED3041= 10W 3000K, 41 Degree Wide, GU5.3 Base
10LED4012= 10W 4000K, 12 Degree Spot, GU5.3 Base
10LED4021= 10W 4000K, 21 Degree Narrow, GU5.3 Base
10LED4041= 10W 4000K, 41 Degree Wide, GU5.3 Base
10LED5712= 10W 5700K 12 Degree Spot, GU5.3 Base
10LED5721= 10W 5700K, 21 Degree Narrow, GU5.3 Base
10LED5741= 10W 5700K, 41 Degree Wide, GU5.3 Base

Voltage
12=12V

Finish
Painted
BK=Black
BZ=Bronze
CS=City Silver
VE=Verde
WT=White

Metal
NBR=Brass
NCP=Copper
NSS=Stainless Steel

Accessories
Glare Shield
FH203=Angled Glare Shield, MR16

Filters
F71=Peach Dichroic Filter, 2.00" Dia
F73=Green Dichroic Filter, 2.00" Dia
F75=Yellow Dichroic Filter, 2.00" Dia
F77=Dark Blue Dichroic Filter, 2.00" Dia
F79=Neutral Density Dichroic Filter, 2.00" Dia
F22=Red Color Filter, 2.00" Dia
F44=Green Color Filter, 2.00" Dia
F66=Mercury Vapor Color Filter, 2.00" Dia

Optical Lenses
LSL=Linear Spread Lens (elongate standard beam spread), 2.00" Dia
DIF=Diffused Lens (provide even illumination), 2.00" Dia

Optical Louver
LVR=Hex Cell Louver (reduce glare), 2.00" Dia

Lamps
EZX=20W MR16 GU5.3 Bi-Pin Very Narrow Spot
BAB=20W MR16 GU5.3 Bi-Pin Flood
FRA=35W MR16 GU5.3 Bi-Pin Spot
EXT=50W MR16 GU5.3 Bi-Pin Narrow Spot
EXN=50W MR16 GU5.3 Bi-Pin Flood

F72=Amber Dichroic Filter, 2.00" Dia
F74=Medium Blue Dichroic Filter, 2.00" Dia
F76=Red Dichroic Filter, 2.00" Dia
F78=Light Blue Dichroic Filter, 2.00" Dia
F80=Magenta Dichroic Filter, 2.00" Dia
F33=Blue Color Filter, 2.00" Dia
F55=Yellow Color Filter, 2.00" Dia

OSL=Overall Spread Lens (increase beam spread), 2.00" Dia

ESX=20W MR16 GU5.3 Bi-Pin Narrow Spot
FRB=35W MR16 GU5.3 Bi-Pin Narrow Spot
FMW=35W MR16 GU5.3 Bi-Pin Flood
EXZ=50W MR16 GU5.3 Bi-Pin Narrow Flood
FNV=50W MR16 GU5.3 Bi-Pin Very Wide Flood

- Notes:
- Lamp not included.
 - 12V remote transformer required - not included.
 - See ACCESSORIES & TECHNICAL DATA section of the Lumière catalog for Low Voltage Cable & Transformers.
 - Consult your Cooper Lighting representative for additional options and finishes.



Excellence in Illumination Engineering Software
since 1984



www.agi32.com

sample banner copyright 2013 Lighting Analysts, Inc.

W1

Photometric Report (Type B)

Filename: W1_904-10LED3041-12-BK.ies
[TEST] P185936 TEST IS SCALED FROM IESNA LM-79-08 TEST
DATA (P26956)
[TESTLAB] INNOVATIONS CENTER-P2
[ISSUEDATE] 1/19/2016
[MANUFAC] EATON - LUMIERE (FORMER COOPER LIGHTING)
[LUMCAT] 10LED3041
[LUMINAIRE] LUMIERE 203, STANDARD RECESSED LENS HOOD
BLACK, 41 DEG LED OPTIC, CLEAR LENS
[LAMP] 3000K CCT, 80 CRI LEDs

Maximum Candela = 1008.8 at 1 H 3 V

Classification:

Luminaire Efficacy Rating (LER): 28
Flood NEMA Type: 4H x 4 V

Axial Candela Display:

Polar Graph

Horizontal Axis (H)
Vertical Axis (V)

