

URBAN DESIGN COMMISSION APPLICATION

UDC

City of Madison
Planning Division
126 S. Hamilton St.
P.O. Box 2985
Madison, WI 53701-2985
(608) 266-4635



FOR OFFICE USE ONLY:

Paid _____ Receipt # _____

Date received _____

Received by _____

Aldermanic District _____

Zoning District _____

Urban Design District _____

Submittal reviewed by _____

Complete all sections of this application, including the desired meeting date and the action requested.

If you need an interpreter, translator, materials in alternate formats or other accommodations to access these forms, please call the phone number above immediately.

1. Project Information

Address: 222 S. Hamilton, Madison, WI

Title: the Barracuda

2. Application Type (check all that apply) and Requested Date

UDC meeting date requested 08.08.18

- New development Alteration to an existing or previously-approved development
 Informational Initial approval Final approval

3. Project Type

- Project in an Urban Design District
 Project in the Downtown Core District (DC), Urban Mixed-Use District (UMX), or Mixed-Use Center District (MXC)
 Project in the Suburban Employment Center District (SEC), Campus Institutional District (CI), or Employment Campus District (EC)
 Planned Development (PD)
 General Development Plan (GDP)
 Specific Implementation Plan (SIP)
 Planned Multi-Use Site or Residential Building Complex

Signage

- Comprehensive Design Review (CDR)
 Signage Variance (i.e. modification of signage height, area, and setback)

Other

- Please specify _____

4. Applicant, Agent, and Property Owner Information

Applicant name Christopher Gosch Company Populance, llc

Street address 104 King Street City/State/Zip Madison, WI 53703

Telephone 608.333.1926 Email cgosch@populance.com

Project contact person Christopher Gosch Company Populance, llc

Street address 104 King Street City/State/Zip Madison, WI 53703

Telephone 608.333.1926 Email cgosch@populance.com

Property owner (if not applicant) Romanov Holdings, LLC- Contact person: Jim Stopples, MPM

Street address PO Box 5603 City/State/Zip Madison, WI 53705

Telephone 608.251.8777 Email jim@madisonproperty.com

5. Required Submittal Materials

- Application Form**
- Letter of Intent**
 - If the project is within an Urban Design District, a summary of how the development proposal addresses the district criteria is required
 - For signage applications, a summary of how the proposed signage is consistent with the applicable CDR or Signage Variance review criteria is required.
- Development plans** (Refer to checklist provided below for plan details)
- Filing fee**
- Electronic Submittal***

Each submittal must include fourteen (14) 11" x 17" collated paper copies. Landscape and Lighting plans (if required) must be full-sized. Please refrain from using plastic covers or spiral binding.

Both the paper copies and electronic copies must be submitted prior to the application deadline before an application will be scheduled for a UDC meeting. Late materials will not be accepted. A completed application form is required for each UDC appearance.

For projects also requiring Plan Commission approval, applicants must also have submitted an accepted application for Plan Commission consideration prior to obtaining any formal action (initial or final approval) from the UDC. All plans must be legible when reduced.

**Electronic copies of all items submitted in hard copy are required. Individual PDF files of each item submitted should be compiled on a CD or flash drive, or submitted via email to udcapplications@cityofmadison.com. The email must include the project address, project name, and applicant name. Electronic submittals via file hosting services (such as Dropbox.com) are not allowed. Applicants who are unable to provide the materials electronically should contact the Planning Division at (608) 266-4635 for assistance.*

6. Applicant Declarations

1. Prior to submitting this application, the applicant is required to discuss the proposed project with Urban Design Commission staff. This application was discussed with Janine Glaeser on 07.16.18.
2. The applicant attests that all required materials are included in this submittal and understands that if any required information is not provided by the application deadline, the application will not be placed on an Urban Design Commission agenda for consideration.

Applicant name Christopher Gosch Relationship to property Member of Development team

Authorized signature of Property Owner Robert Shapiro Date 07.17.18

7. Application Filing Fees

Fees are required to be paid with the first application for either initial or final approval of a project, unless the project is part of the combined application process involving the Urban Design Commission in conjunction with Plan Commission and/or Common Council consideration. Make checks payable to City Treasurer. Credit cards may be used for application fees of less than \$1,000.

Please consult the schedule below for the appropriate fee for your request:

- Urban Design Districts: \$350 (per §35.24(6) MGO).
- Minor Alteration in the Downtown Core District (DC) or Urban Mixed-Use District (UMX) : \$150 (per §33.24(6)(b) MGO)
- Comprehensive Design Review: \$500 (per §31.041(3)(d)(1)(a) MGO)
- Minor Alteration to a Comprehensive Sign Plan: \$100 (per §31.041(3)(d)(1)(c) MGO)
- All other sign requests to the Urban Design Commission, including, but not limited to: appeals from the decisions of the Zoning Administrator, requests for signage variances (i.e. modifications of signage height, area, and setback), and additional sign code approvals: \$300 (per §31.041(3)(d)(2) MGO)

A filing fee is not required for the following project applications if part of the combined application process involving both Urban Design Commission and Plan Commission:

- Project in the Downtown Core District (DC), Urban Mixed-Use District (UMX), or Mixed-Use Center District (MXC)
- Project in the Suburban Employment Center District (SEC), Campus Institutional District (CI), or Employment Campus District (EC)
- Planned Development (PD): General Development Plan (GDP) and/or Specific Implementation Plan (SIP)
- Planned Multi-Use Site or Residential Building Complex

URBAN DESIGN DEVELOPMENT PLANS CHECKLIST

The items listed below are minimal application requirements for the type of approval indicated. Please note that the UDC and/or staff may require additional information in order to have a complete understanding of the project.

1. Informational Presentation

- Locator Map
- Letter of Intent (If the project is within a Urban Design District, a summary of how the development proposal addresses the district criteria is required)
- Contextual site information, including photographs and layout of adjacent buildings/structures
- Site Plan
- Two-dimensional (2D) images of proposed buildings or structures.

Providing additional information beyond these minimums may generate a greater level of feedback from the Commission.

Requirements for All Plan Sheets

1. Title block
2. Sheet number
3. North arrow
4. Scale, both written and graphic
5. Date
6. Fully dimensioned plans, scaled at 1"= 40' or larger

**** All plans must be legible, including the full-sized landscape and lighting plans (if required)**

2. Initial Approval

- Locator Map
- Letter of Intent (If the project is within a Urban Design District, a summary of how the development proposal addresses the district criteria is required)
- Contextual site information, including photographs and layout of adjacent buildings/structures
- Site Plan showing location of existing and proposed buildings, walks, drives, bike lanes, bike parking, and existing trees over 18" diameter
- Landscape Plan and Plant List (*must be legible*)
- Building Elevations in both black & white and color for all building sides (include material callouts)
- PD text and Letter of Intent (if applicable)

Providing additional information beyond these minimums may generate a greater level of feedback from the Commission.

3. Final Approval

All the requirements of the Initial Approval (see above), **plus:**

- Grading Plan
- Proposed Signage (if applicable)
- Lighting Plan, including fixture cut sheets and photometrics plan (*must be legible*)
- Utility/HVAC equipment location and screening details (with a rooftop plan if roof-mounted)
- PD text and Letter of Intent (if applicable)
- Samples of the exterior building materials (presented at the UDC meeting)

4. Comprehensive Design Review (CDR) and Variance Requests (Signage applications only)

- Locator Map
- Letter of Intent (a summary of how the proposed signage is consistent with the CDR or Signage Variance criteria is required)
- Contextual site information, including photographs of existing signage both on site and within proximity to the project site
- Site Plan showing the location of existing signage and proposed signage, dimensioned signage setbacks, sidewalks, driveways, and right-of-ways
- Proposed signage graphics (fully dimensioned, scaled drawings, including materials and colors, and night view)
- Perspective renderings (emphasis on pedestrian/automobile scale viewsheds)
- Graphic of the proposed signage as it relates to what the Ch. 31, MGO would permit



SUMMARY

PROJECT ADDRESS: 222 S. Hamilton St.; Madison, WI
APPLICATION TYPE: Conditional Use: MGO 28E-2; Multi-family dwelling (> 8 dwelling units)
PREPARED BY: Populance, llc

APPLICANT:

Henry Hamilton Partners, llc
 104 King Street, Madison, WI 53703

CURRENT PROPERTY OWNER:

Romanov Holdings, LLC
 PO Box 5603 Madison, WI 53705

REQUESTED ACTIONS:

Approval of a conditional use to allow construction of a mixed-use building with 930 square feet of commercial space, 19 owner-occupied condominiums, and 19 structured parking stalls to be constructed at 222 South Hamilton Street. A demolition request for an existing 2 story office building on site is also part of this submittal.

PROPOSAL SUMMARY:

The applicant wishes to demolish an existing 2 story office building and construct a six story, 42,000 gross square-foot mixed-use building with 930 square feet of ground floor commercial space and 19 owner occupied condominiums with structured parking for 19 autos. The applicant proposes to commence construction in October 2018, with completion anticipated by the summer of 2019.

PROJECT SCHEDULE:

- 12.20.17 Initial contact with District 4 Alder, Mike Verveer
- 02.25.18 Initial contact with Basset Neighborhood President, Jonathon Cooper
- 11.18-current Contact with City Staff regarding various project components
- 03.02.18 Meeting with City Staff
- 02.21.18 Demo request to Alder
- 02.21.18 Demo Listserv Notification
- 03.12.18 Neighborhood Meeting
- 05.07.18 Steering Committee Meeting
- 05.31.18 DAT Meeting
- 07.05.18 Steering Committee Meeting
- 07.09.18 Contact with Urban Design Commission
- 07.12.18 Special Neighborhood Meeting
- 07.16.18 UDC pre-conference
- 07.18.18 Plan Commission Submittal

APPLICABLE REGULATIONS & STANDARDS

MGO Chapter 28
 MGO Subchapter 28E
 City of Madison Comprehensive Plan
 Basset Neighborhood Plan

SUBCHAPTER 28E: DOWNTOWN AND URBAN DISTRICTS ZONING CODE

28.071 GENERAL PROVISIONS FOR DOWNTOWN AND URBAN DISTRICTS.

(1) *Statement of Purpose.*

- (a) Recognize and enhance Downtown as the civic and cultural center of the City and region; the seat of state, county, and city government, and a significant retail, entertainment, and employment center;
- (b) Recognize and enhance the unique characteristics of Downtown neighborhoods;
- (c) Recognize the architectural heritage and cultural resources of Downtown neighborhoods;
- (d) Facilitate context-sensitive development;
- (e) Foster development with high-quality architecture and urban design;
- (f) Protect important views as identified in the Downtown Plan.

28.071(2)(a) DOWNTOWN HEIGHT MAP

ALLOWED = 6 Stories
 PROPOSED = 6 Stories
 ✓ Complies

28.071(2)(a) Downtown Height Map



28.071(2)(c) DOWNTOWN STEPBACK MAP

REQUIRED: S. Hamilton St. = 15'-0" stepback above 4 stories
 PROPOSED = 15'-0" stepback at 5th floor
 ✓ Complies

28.071(2)(c) Downtown Stepback Map



28.076 URBAN MIXED-USE (UMX) DISTRICT.

(1) *Statement of Purpose.*

This district is intended to provide opportunities for high-density residential and office uses in combination with limited retail and service uses designed to serve the immediate surroundings.

TABLE 28E-2 Designates the following:

- Professional Office: **Permitted Use**
- Multi-family dwelling (> 8 dwelling units): **Requires Conditional Use approval**

28.071 (3) Design Standards.

The following standards are applicable to all new buildings and additions, within any ten- (10) year period, exceeding fifty percent (50%) of existing building's floor area for non-residential buildings, mixed-use buildings, lodging houses, and residential buildings with 8 or more dwelling units.

(a) Parking.

1. Parking shall be located in parking structures, underground, or in surface parking lots behind principal buildings. Parking structures shall be designed with liner buildings or with ground floor office or retail uses along all street-facing facades.

Liner Building:

(a) Building Type. A specialized building, parallel to the street, which is designed to conceal an area such as a parking lot or loading dock.

(b) Access and Entry. The principal entry to each ground floor unit shall be a direct entrance from the primary abutting street.

(c) Massing and Articulation. Maximum building length parallel to the primary abutting street shall not exceed three hundred (300) feet without a visual break such as a courtyard or recess. Minimum building depth is sixteen (16) feet. Facades facing a public street shall be vertically articulated a a minimum interval of forty (40) feet. Entrances shall be provided at least every forty (40) feet along the primary abutting street.

✓Complies

2. For corner lots or through lots, rear yard surface parking areas abutting any street frontage are limited to fifty percent (50%) of that frontage, and shall be located a minimum of ten (10) feet from the street property line.

✓Complies

3. Parking garage openings visible from the sidewalk shall have a clear maximum height of sixteen (16) feet and a maximum width of twenty-two (22) feet. Garage doors or gates shall be located a minimum of ten (10) feet from the front property line. Doors to freight loading bays are exempt from this requirement.

✓Complies

4. No doors or building openings providing motor vehicle access to structured parking or loading facilities shall face State Street, King Street, or the Capitol Square.

✓N/A

(b) Entrance Orientation.

1. Primary building entrances on all new buildings shall be oriented to the primary abutting public street and have a functional door.

✓Complies

2. Additional secondary entrances may be oriented to a secondary street or parking area.

✓Complies

3. Entries shall be clearly visible and identifiable from the street, and delineated with elements such as roof overhangs, recessed entries, landscaping, or similar design features.

✓Complies

4. Within ten (10) feet of a block corner, the facade may be set back to form a corner entry.

✓N/A

(c) Facade Articulation.

1. The facades of new buildings more than forty (40) feet in width shall be divided into smaller vertical intervals through techniques including but not limited to the following:
 - a. Facade modulation, step backs, or extending forward of a portion of the facade.
 - b. Vertical divisions using different textures, materials, or colors of materials.
 - c. Division into multiple storefronts, with separate display windows and entrances.
 - d. Variation in roof lines to reinforce the modulation or vertical intervals.
 - e. Arcades, awnings, window bays, arched windows, and balconies to reinforce the vertical intervals.

✓Complies

(d) Story Heights and Treatment.

1. For all buildings, the maximum ground story height is eighteen (18) feet, measured from the sidewalk to the second story floor. An atrium that exceeds eighteen (18) feet will be considered more than one (1) story.

✓Complies

2. Upper stories shall not exceed fourteen (14) feet floor to floor.

✓Complies

3. For all buildings, the minimum ground story height is twelve (12) feet, measured from the sidewalk to the second story floor.

✓Complies

4. For non-residential uses, the average ground story floor elevation shall not be lower than the front sidewalk elevation nor higher than eighteen (18) inches above the sidewalk elevation.

✓Complies

5. For ground-story residential uses, landscaping, steps, porches, grade changes, and low ornamental fences or walls or similar treatments shall be located between the sidewalk and the front door to create a private yard area.

✓N/A

(e) Door and Window Openings.

1. For street-facing facades with ground story non-residential uses, the ground story door and window openings shall comprise a minimum of fifty percent (50%) of the facade area.

✓Complies

2. For street-facing facades with ground story residential uses, ground story openings shall comprise a minimum of fifteen percent (15%) of the facade area.

✓Complies

3. For all buildings, upper story openings shall comprise a minimum of fifteen percent (15%) of the facade area per story.

✓Complies

4. Garage doors and opaque service doors shall not count toward the above requirements.

✓Complies

5. Glass on all windows and doors shall be clear or slightly tinted, allowing views into and out of the interior. Spandrel glass may be used on service areas on the building.

✓Complies

f. Building Materials.

1. Buildings shall be constructed of durable, high-quality materials. Table 28 E-1 below lists allowable building materials.

✓Complies

Table 28E-1: Building Materials in Downtown and Urban Districts.

Building Materials	Trim / Accent Material	Top of Building	Middle of Building	Base / Bottom of Building	Standards (see footnotes)
Brick (Face/Veneer)	✓	✓	✓	✓	
Smooth-Face / Split-Face Block	✓	✓	✓	✓	A
Wood / Wood Composite	✓	✓	✓	✓	B
Fiber-Cement Siding / Panels	✓	✓	✓	✓	B
Concrete Panels (Tilt-up or Precast)	✓	✓	✓	✓	C
EIFS / Synthetic Stucco	✓	✓	✓	✓	D
Stone / Stone Veneer	✓	✓	✓	✓	
Metal Panels	✓	✓	✓	✓	E
Hand-Laid Stucco	✓	✓			D
Reflective Glass / Spandrel	✓				F
Glass (Transparent)	✓	✓	✓	✓	

A- Shall be used in conjunction with a palette of materials and shall not comprise more than thirty-three percent (33%) of any building.
 B- Wood and fiber cement panels shall not be used on the ground story except between the sidewalk and the bottom of storefront windows or as an accent material.
 C- Shall incorporate horizontal and vertical articulation and modulation, including but not limited to changes in color and texture, or as part of a palette of materials.
 D- Shall not be within three feet of the ground or used on building facades facing State Street, King Street, or the Capitol Square.
 E- Shall be used in conjunction with a palette of materials; shall be a heavy gauge, non-reflective metal
 F- Shall be used in limited quantities as an accent material.

2. All building facades visible from a public street or public walkway shall use materials and design features similar to or complementary to those of the front facade.

✓Complies

g. Equipment and Service Area Screening.

1. Outdoor loading areas or mechanical equipment are not permitted in the front yard. When visible from an abutting public street or walkway, they shall be screened by a decorative fence, wall, or screen of plant material.

✓Complies

2. No doors or openings providing access to parking or loading facilities shall abut the Capitol Square, State Street or King Street.

✓N/A

3. Fences and walls shall be architecturally compatible with the principal structure.

✓Complies

h. Screening of Rooftop Equipment

1. All rooftop equipment, with the exception of solar and wind equipment, shall be screened from view from adjacent streets and public rights-of-way. Rooftop equipment shall be screened from view from adjacent buildings to the extent possible.

✓Complies

2. The equipment shall be within an enclosure. This structure shall be set back a distance of one and one-half (1½) times its height from any primary facade fronting a public street. Screens shall be of durable, permanent materials (not including wood) that are compatible with the primary building materials.

✓Complies

28.183- Conditional Use

Section 28.183 provides the process and standards for the approval of conditional use permits.

The criteria for new developments in Downtown Districts are found in Section 28.071(3)

Review Required By: Urban Design Commission and Plan Commission.

28.183(6) Approval Standards.

(a) The City Plan Commission shall not approve a conditional use without due consideration of the recommendations in the City of Madison Comprehensive Plan and any applicable, neighborhood, neighborhood development, or special area plan, including design guidelines adopted as supplements to these plans. No application for a conditional use shall be granted by the Plan Commission unless it finds that all of the following conditions are present:

1: The establishment, maintenance or operation of the conditional use will not be detrimental to or endanger the public health, safety, or general welfare.

Provides additional Housing options for a dynamic urban environment

2: The City is able to provide municipal services to the property where the conditional use is proposed, given due consideration of the cost of providing those services.

All Municipal Services and infrastructure are existing and service site

3: The uses, values and enjoyment of other property in the neighborhood for purposes already established will not be substantially impaired or diminished in any foreseeable manner.

Provides a complementary use to adjacent properties and uses

4: The establishment of the conditional use will not impede the normal and orderly development and improvement of the surrounding property for uses permitted in the district.

Would have no effect on surrounding property and uses

5: Adequate utilities, access roads, drainage, parking supply, internal circulation improvements, including but not limited to vehicular, pedestrian, bicycle, public transit and other necessary site improvements have been or are being provided.

All Municipal Services and infrastructure are existing and service site

6: Measures, which may include transportation demand management (TDM) and participation in a transportation management association have been or will be taken to provide adequate ingress and egress, including all off-site improvements, so designed as to minimize traffic congestion and to ensure public safety and adequate traffic flow, both on-site and on the public streets.

All entry points to the site have been discussed with City Staff. Proposed Vision Triangle of 25'-0" is adequate for the Henry/Hamilton/Wilson triangular intersection and 10'-0" vision triangles are required at other access points/drive aisles.

7: The conditional use conforms to all applicable regulations of the district in which it is located.

Proposed project is in conformance with MGO Subchapter 28E

8: When applying the above standards to an application by a community living arrangement, the Plan Commission shall:

a: Bear in mind the City general intent to accommodate community living arrangements.

b: Exercise care to avoid an over-concentration of community living arrangements, which could create an institutional setting and seriously strain the existing social structure of a community. Considerations relevant for this determination are the distance between the proposed facility and other such facilities, the capacity of the proposed facility and the percentage by which the facility will increase the population of the community, the total capacity of all community living arrangements in the community, the impact on the community of other community living arrangements, the success or failure of integration into communities of other such facilities operated by the individual or group seeking approval, and the ability of the community to meet the special needs, if any, of the applicant facility.

N/A

9: When applying the above standards to any new construction of a building or an addition to an existing building the Plan Commission shall find that the project creates an environment of sustained aesthetic desirability compatible with the existing or intended character of the area and the statement of purpose for the zoning district. In order to find that this standard is met, the Plan Commission may require the applicant to submit plans to the Urban Design Commission for comment and recommendation.

Project will be submitted to the Urban Design Commission

10: When applying the above standards to an application for a reduction in off-street parking requirements, the Plan Commission shall consider and give decisive weight to all relevant facts, including but not limited to, the availability and accessibility of alternative parking; impact on adjacent residential neighborhoods; existing or potential shared parking arrangements; number of residential parking permits issued for the area; proximity to transit routes and/or bicycle paths and provision of bicycle racks; the proportion of the total parking required that is represented by the requested reduction; the proportion of the total parking required that is decreased by Sec. 28.141. The characteristics of the use, including hours of operation and peak parking demand times design and maintenance of off-street parking that will be provided; and whether the proposed use is now or a small addition to an existing use. N/A

11: N/A- Proposed project not a telecommunication facility

12: N/A- Project proposal does not exceed Max. Building heights per 28.071(2)(a)

13: N/A- Proposed project not a lakefront development.

14: N/A- Project proposal does not exceed Max. Building heights per 28.071(2)(a)

BACKGROUND INFORMATION

Parcel Location: An approximately 7,867 s.f. (0.18-acre) parcel located at the triangular intersecting corner of S. Hamilton, S. Henry, and W. Wilson; Aldermanic District 4 (Verveer); Downtown District; Madison Metropolitan School District.

Existing Conditions and Land Use: Existing 2 story Office building, built approx.. 1961, zoned UMX (Urban Mixed Use).
 Surrounding Land Uses and Zoning:

North: Single-family house converted to Offices, zoned UMX

South: Multi-Family rental house conversions, zoned UMX

West: Multi-Family rental house conversions, zoned UMX, (1) owner occupied single family, zoned DR-2 and PD

East: Dane County Courthouse, zoned PD

Adjacent Streets:

Hamilton: One-way (north); No street parking along parcel, no parking along opposite side of street

Henry: Two-way; No street parking on parcel side of street (east). 2 hr parking along a portion of opposite side of street
 Fire lanes can be utilized on either Hamilton or Henry Streets.

Adopted Land Use Plans: The Comprehensive Plan designates the property and context as part of the Downtown Core (Volume II, Map 2-3).

Site is also in a Potential Redevelopment & Infill Area (Volume II, Map 2-5)

The 1997 Basset Neighborhood Master Plan identifies the parcel as part of the State Capitol Mixed Use Zone and encourages an intensive mixed use zone including very high density residential development.

Zoning Summary: The site is zoned **UMX (Urban Mixed-Use)**:

Site is on a triangular lot. Yard designations were determined by zoning staff on 02.27.18:

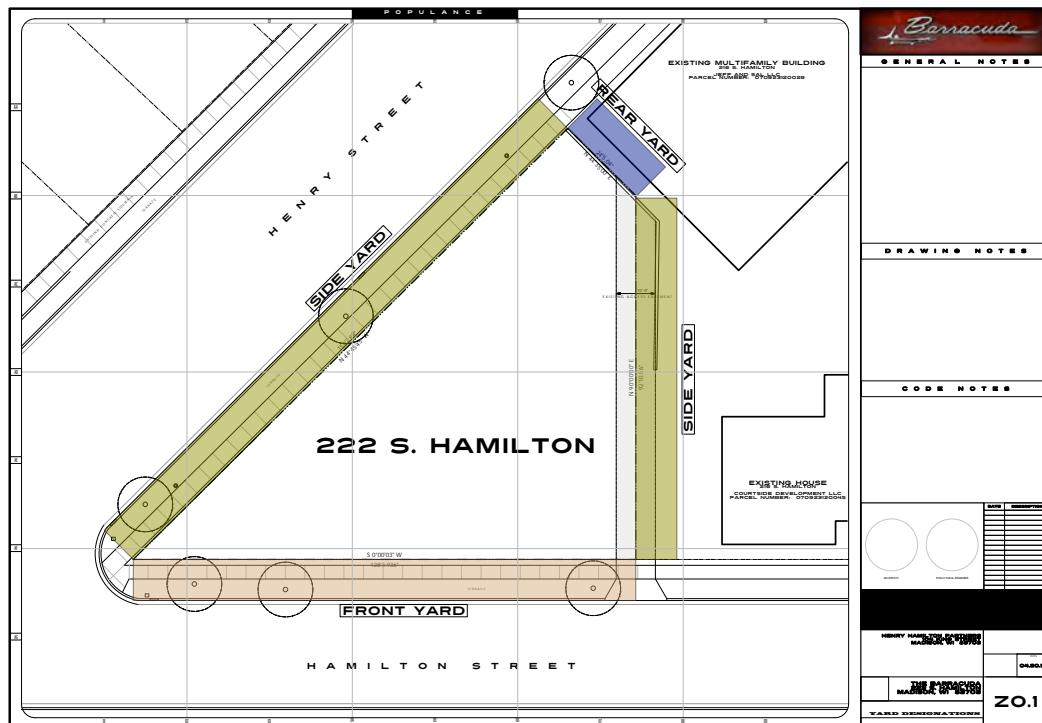

Mixed Use Building:

Requirements	Required	Proposed
Front Yard	0' Minimum	2'-0"-5'-0"
Side Yards	0' Minimum	2'-0"-15'-0"
Rear Yard	10'-0"	10'-0"
Useable Open Space	10 sq. ft. per bedroom 38 bedrooms = 380 s.f. required	227 sq. ft. at grade; 2850 sq. ft. balconies (3077 sq. ft. total)
Maximum Lot Coverage	90%	77%
Maximum Building Height	6 stories	6 stories
AutoParking	No minimum	19
Bike Parking	1 per dwelling unit + 1 visitor stall per 10 res. units = (21); Office: 1 per 2,000 sq. ft. floor area (1) (22 total)	5 surface; 17 underground (22 total)
Loading	N/A	0
Building Forms	Large Multi-Family/ Commercial Block	Large Multi-Family/ Commercial Block
Other Critical Zoning Items		
Yes:	Urban Design (Downtown District), Barrier Free, Access Easements	
No:	Floodplain, Wellhead Protection, Landmarks, Waterfront Development, Adjacent to Park, Historic District	

Environmental Corridor Status: The property is not located in a mapped environmental corridor.

Public Utilities and Services: The site is served by a full range of urban services, including Metro Transit service

PROJECT DESCRIPTION

The applicant has submitted a request for conditional use approval for 0.18-acre parcel located at the triangular corner of S. Hamilton, S. Henry, and W. Wilson. The request calls for the construction of a six-story mixed-use building that will contain 930 square feet of ground floor commercial space and 19 owner occupied condominium units.

The proposed six-story mixed-use building will parallel S. Hamilton and S. Henry with a new parking entrance off S. Henry and an existing parking entry off S. Hamilton, with the primary pedestrian entrance and building lobby off S. Henry. The commercial space will be located on the southern tip of the ground floor, with an entrance proposed on S. Hamilton street.

On the first floor, the applicant proposes a residential lobby and landscaped commons along the western façade and one condominium unit. The eastern driveway will provide separate access to structured parking that will include 10 auto parking stalls and 17 bike parking stalls. The area between the sidewalk and building is landscaped open space; a second, smaller open space is proposed at the southern tip of the property. The upper 5 floors of the building will contain the remaining 18 dwelling units. Overall, the 19 condominium units proposed will consist of 19 two-bedroom units.

Elevations of the building propose a contemporary commercial building to be clad with a combination of Composite Wood, Glass, and Stone with a distinct base, middle and top.

BUILDING AREA

Level	Name	Area
GROUND FLOOR	GROUND FLOOR	6,107 SF
1ST FLOOR	FIRST FLOOR	6,378 SF
2ND FLOOR	2ND FLOOR	7,015 SF
3RD FLOOR	3RD FLOOR	7,043 SF
4TH FLOOR	4TH FLOOR	7,010 SF
5TH FLOOR	5TH FLOOR	5,362 SF
6TH FLOOR	6TH FLOOR	5,372 SF
TOTAL		44,287 SF

UNIT MATRIX

Level	Number	Size (s.f.)	Bedrooms	Bathrooms
1ST FLOOR	101	1,515	2	2
Total Units: 1		1,515		
2ND FLOOR	201	1,433	2	2
	202	1,726	2	2
	203	1,587	2	2
	204	1,438	2	2
Total Units: 4		6,184		
3RD FLOOR	301	1,726	2	2
	302	1,588	2	2
	303	1,444	2	2
	304	1,433	2	2
Total Units: 4		6,191		
4TH FLOOR	401	1,726	2	2
	402	1,588	2	2
	403	1,449	2	2
	404	1,433	2	2
Total Units: 4		6,196		
5TH FLOOR	501	1,695	2	2
	502	1,442	2	2
	503	1,449	2	2
Total Units: 3		4,586		
6TH FLOOR	601	1,696	2	2
	602	1,443	2	2
	603	1,449	2	2
Total Units: 3		4,588		
TOTALS: 19 units		29,260	38	38

DEMOLITION OF EXISTING BUILDING

The Zoning Code **Sec. 28.185** includes the following provisions regarding approval of the Demolition and Removal of buildings:

(1) Statement of Purpose.

It is hereby declared a matter of public policy that the good maintenance and rehabilitation of existing buildings, the preservation of safe and sanitary housing available at reasonable prices, and the careful consideration and planning of changes in the urban landscape are a public necessity and are required in the interest of the health, prosperity, safety, and welfare of the people. The purpose of this section is to aid in the implementation of adopted City plans, protect neighborhood character, preserve historic buildings, encourage the reuse and/or relocation of existing buildings, discourage buildings falling into a state of severe disrepair from lack of maintenance by the owner, encourage compliance with building and minimum housing codes, and allow the property owner to have a decision on approval or disapproval of the proposed use of the property before he or she takes the irrevocable step of demolishing or moving his or her existing building or buildings.

(2) Applicability and Initiation.

(a) An application for a demolition or removal permit shall contain a clear, detailed and complete statement of the present or most recent use and any use proposed to be made of the property if the demolition or removal permit is approved.

COMPLIES: Proposed Project Plan submitted to Plan Commission for Conditional Use and Demolition Approvals

P O P U L A N C E

(b) An application for a permit also shall include plans for any proposed future use, including site, grading and landscaping plans, floor plans, building elevations and materials, the length of the current ownership, and photographs of the interior and exterior of the building(s). A written report of a licensed architect or engineer describing the condition of the building(s) may be submitted to substantiate the request.

COMPLIES: Proposed Project Plan (including assessment by licensed Architect) submitted to Plan Commission for Conditional Use and Demolition Approvals

(7) Approval Standards.

Applications for demolition or removal permits shall not be approved, except as provided in (6) above, unless the following standards are met:

(a) Applications With a Proposed Future Use.

1. The Zoning Administrator issues a zoning certificate for the proposed use of the property. For the purpose of this subdivision, a zoning certificate shall mean a certification in writing that the proposed use of the property would be in compliance with the provisions of the Zoning Code.
 - a. If the Zoning Administrator finds that the proposed use of the property is not in compliance with the provisions of the Zoning Code, the applicant for a demolition or removal permit may apply for a map or text amendment pursuant to Sec. 28.182 or for a conditional use permit pursuant to Sec. 28.183 for the proposed use. All of the provisions of Secs. 28.182 and 28.183 shall apply to said applications, except that the time limit for commencement of the conditional use, pursuant to Sec. 28.183(9), shall be eighteen (18) months instead of twelve (12) months.
 - b. If after the procedures provided in Paragraph 1.a. are followed, the proposed use of the property would be in compliance with the provisions of the Zoning Code, the Zoning Administrator shall grant zoning approval for the proposed use, pursuant to Sec. 28.202(3).

Proposed project meets all Planning and Zoning standards currently adopted at time of submittal
2. The Plan Commission finds that both the requested demolition or removal and the proposed use are compatible with the purpose of this section and the intent and purpose expressed in the Zoning Code for the zoning district in which the property is located. Furthermore, the proposed use should be compatible with adopted neighborhood plans, the Comprehensive Plan or with any applicable neighborhood conservation district requirements. When making this finding the Commission shall consider and may give decisive weight to any relevant facts, including but not limited to:
 - a. The effects the proposed demolition or removal and proposed use of the subject property would have on the normal and orderly development and improvement of surrounding properties.
 - b. The reasonableness of efforts to relocate the building, including but not limited to the costs of relocation, the structural soundness of the building; and
 - c. The limits that the location of the building would place on efforts to relocate it, and the availability of affordable housing.

No existing housing, affordable or otherwise is affected by the demolition of the existing building.
4. In the case of landmarks or improvements located in a local Historic District, consideration and approval of demolition or removal permits by the Plan Commission shall be contingent upon the prior issuance of a certificate of appropriateness by the Landmarks Commission pursuant to Sec. 33.01(5)(c), MGO.

Proposed project is not a Landmarked building nor is it located in a Historic District.
5. The Plan Commission shall consider the report of the City's historic preservation planner regarding the historic value of the property as well as any report submitted by the Landmarks Commission.
6. If a demolition or removal permit is approved, it shall not be issued until the reuse and recycling plan is approved by the Recycling Coordinator.

Reuse and Recycling Plan has been submitted as part of the Plan Commission Package.

ANALYSIS AND CONCLUSION

Any mixed-use building with greater than 8 units in the UMX zoning requires approval as a **conditional use**. The Plan Commission may not approve an application for a conditional use unless it can find that all of the standards found in Section 28.183(6)(a), Approval Standards for Conditional Uses, are met.

That section states: "The City Plan Commission shall not approve a conditional use without due consideration of the recommendations in the City of Madison Comprehensive Plan and any applicable, neighborhood, neighborhood development, or special area plan, including design guidelines adopted as supplements to these plans. No application for a conditional use shall be granted by the Plan Commission unless it finds that all of the following conditions are present."

The Applicant specifically believes that the conditional use standards can be met for the proposed mixed-use building. Applicant believes that the proposed development will have a positive impact on the uses, values and enjoyment or normal and orderly development of surrounding properties, and will not create an adverse impact on the City's ability to provide services to the site.

Applicant also believes that approval of the project will not create an undue impact on traffic, circulation or parking in the surrounding area, based on the small amount of parking provided and multiple access points.

The proposed redevelopment of the site is consistent with the statement of purpose for the UMX zoning district, which was established to recognize corridors in the City that are largely pedestrian oriented, and encourage their redevelopment into mixed-use projects that are conducive to pedestrian, bicycle, transit and motor vehicle activity.

The project is also consistent with the neighborhood commercial recommendation applied to the site and adjacent properties the 1997 Bassett Neighborhood Master Plan, which was developed to create a neighborhood stabilization and redevelopment vision for the area of the City located near the Capitol and more intensive residential uses west of the Capitol.

Applicant believes that the mixed-use building can also meet the requirements for new development in the Downtown Core sufficiently for the Urban Design Commission to grant the project approval.

Applicant believes that the project, as an owner occupied mixed use development, fills a much needed demand for stable housing product in the Downtown Core. Project will be the first owner occupied multifamily project in the Downtown core since 2007.

The project provides the effective screening of parking recommended by the district, with all of the proposed structured parking concealed. Further, the architecture of the building suggests that it can meet the district goals for contemporary architecture and massing, and for materials and colors of new buildings to be durable, low maintenance, and harmonious with each other and with other buildings in the neighborhood.

Additional Items:

- 1: Project is NOT located in a Historic District as designated by the Landmarks Commission
- 2: The nearest designated landmark buildings are on the 100 and 300 blocks of Hamilton (Baskerville and Stoner House)

E N D

EXISTING BUILDING ASSESSMENT

Address:	222 S. Hamilton Street, Madison, WI
Current Use:	Office
Type of Construction:	III A
Construction:	Steel Frame with masonry exterior and wood truss roof
Stories:	2 above grade/basement
Sprinklered:	NO
Meets current Accessibility Requirements:	NO
Can be converted to meet current Accessibility Requirements:	Unlikely, Presents considerable hardships and cost disproportionality.

DESCRIPTION:

Existing structure was built in 1955 for use as an office building. Building style is approximating a semi-Georgian Revival with several elements, including columns and a pediment at the front entry. The windows and articulation of the rest of the elevations do not carry over any of the design language and are flat surfaces with little to no architectural detail.

The casement windows are another deviation from the faux Georgian style seen at the entry elevation. It is assumed that those are not the original windows, but no information could be found as to a replacement date.

The building is symmetrical about an axis on site that is skewed somewhere between the Hamilton and Henry Street axes that creates an unusual main entry facade that is not directly related to either street.

The building is subdivided up into offices served by a double loaded corridor and open stairs serving all levels.

NOTE: Photos of the existing building exterior and interior are contained in the Barracuda Project Plan Commission submittal

STRUCTURE/CLADDING/ROOF:

The structure consists of concrete foundation walls, steel framing for the first and second floors (approx. 22'-0" bay spacing) and wood roof trusses.

Floor systems appear to be a composite concrete deck with a combination of carpet and terrazzo floor finishes in the common areas and corridors and carpet in the offices. Bathrooms received a ceramic tile finish

The structure is in relatively good shape, with signs of deferred maintenance appearing. Several areas of the exterior brick cladding would be candidates for re-pointing, but no major water infiltration was evident during the inspection.

The asphalt shingle roof appears to be 15+ years old and would need to be replaced in the medium term. No visible signs of water infiltration or damage were evident.

WINDOWS:

The windows were aluminum single pane casement windows, and it is not known if these are the original or replacement windows. Many frames were showing signs of distress and oxidation. Average window size is 32" h x 50" w, with clear glass. Smaller windows with obscure glass are used in the bathroom areas.

MECHANICAL:

The mechanical system is a lower efficiency gas boiler for a hot water baseboard system. The boiler appeared to be maintained, however the age was 30+ years.

ACCESSIBILITY:

As is common with buildings of this age, there are no accessible routes from the sidewalk or parking are to any level of the building, with obstructions, curbs, and stairs preventing any accessible access. In addition to the lack of accessible routes, there is no elevator serving the different building floors. The public bathrooms are situated such that there is one bathroom per floor. The Women's Restroom is on the 2nd floor, the Men's bathroom is on the 1st Floor, and there are no restrooms on the basement level.

The bathrooms provide minimal to no maneuvering clearances and none meet the minimal accessible design standard requirements of today.

SUMMARY AND RECOMMENDATIONS:

Although the building has aged appropriately with minimal maintenance and poses no immediate hazard, the combination of inefficient design and mechanicals, no accessibility accommodations and the general odd placement on the site, creates a condition where we can find no compelling reason why the building should remain.

The Design of the building is a mix of a historical style and mid century suburban blankness and anonymity with no defining architectural or period significance.

Respectfully submitted,

Christopher Gosch

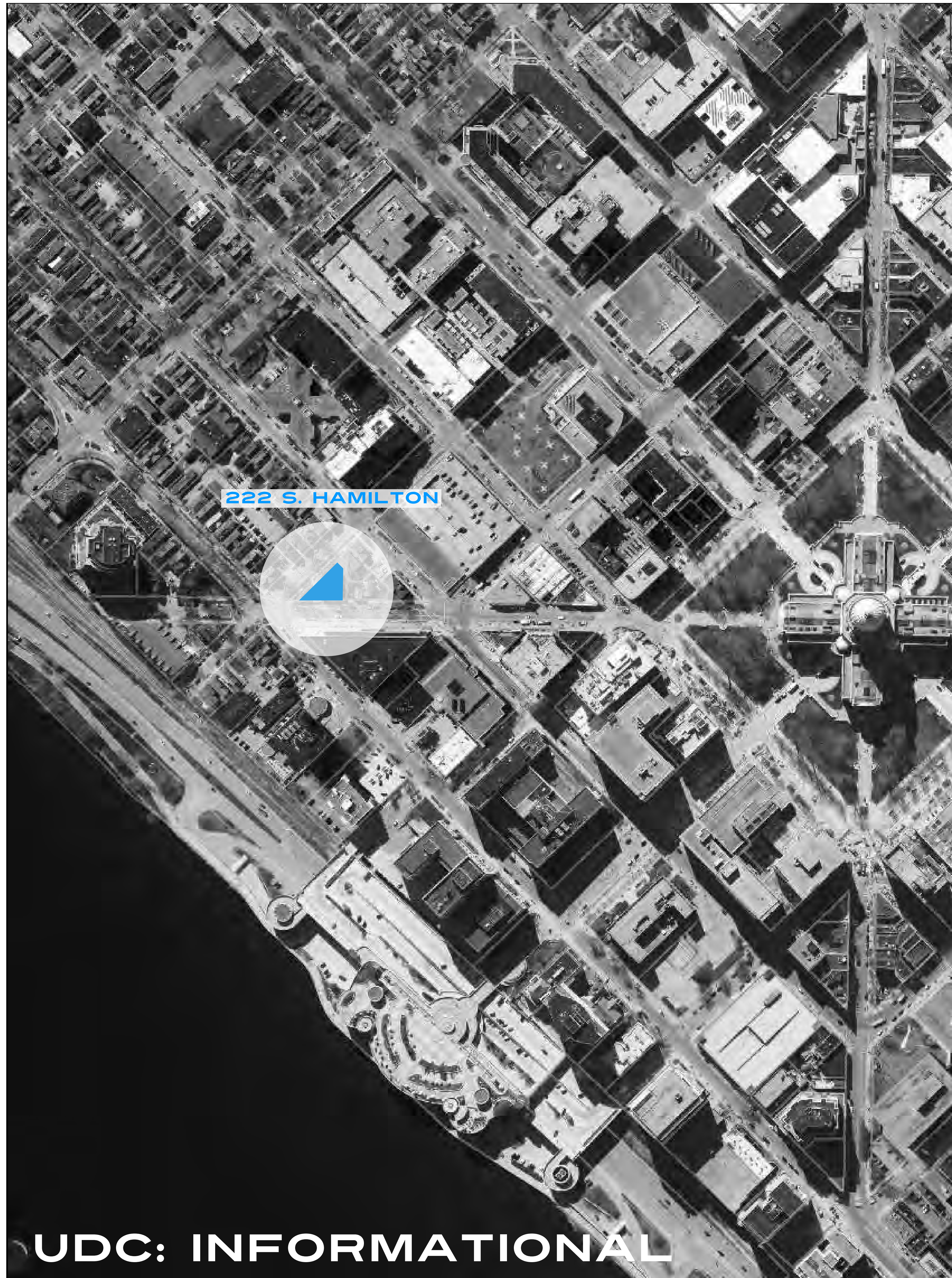

222 S. HAMILTON



UDC: INFORMATIONAL

SURVEY

- CXT.1 PROJECT AND SITE CONTEXT
- CXT.2 PROJECT AND SITE CONTEXT
- CXT.3 PROJECT AND SITE CONTEXT
- CXT.4 PROJECT AND SITE CONTEXT
- CXT.5 PROJECT AND SITE CONTEXT

- C0.01 OVERALL SITE AND ACCESS PLAN
- C0.02 ZONING ANALYSIS
- C0.03 ZONING ANALYSIS
- C0.04 SITE SECTION: HAMILTON
- C0.05 SITE SECTION: HENRY
- C0.06 SITE SECTION

- C1.01 SITE DEMOLITION PLAN
- C1.02 EXISTING BUILDING PICTURES: EXTERIOR
- C1.03 EXISTING BUILDING PICTURES: INTERIOR
- C2.01 GRADING AND EROSION CONTROL PLAN
- C3.01 UTILITY PLAN
- C4.01 FIRE APPARATUS ACCESS PLAN
- C5.01 SITE LIGHTING PLAN
- C5.02 SITE LIGHTING DETAILS
- C6.01 SITE DETAILS
- C7.01 STAGING AND ACCESS PLAN

- L1.01 STREETScape AND LANDSCAPE PLAN
- L2.01 LANDSCAPE DETAILS

- A1.00 GROUND FLOOR PLAN
- A1.01 FIRST FLOOR PLAN
- A1.02 SECOND FLOOR PLAN
- A1.03 THIRD FLOOR PLAN
- A1.04 FOURTH FLOOR PLAN
- A1.05 FIFTH FLOOR PLAN
- A1.06 SIXTH FLOOR PLAN
- A1.07 ROOF PLAN

- A4.01 BUILDING ELEVATION: HAMILTON STREET
- A4.02 BUILDING ELEVATION: HENRY STREET
- A4.03 BUILDING ELEVATION: NORTH (ALLEY)
- A4.04 BUILDING SECTIONS

- A5.01 BUILDING MATERIALS
- A5.02 BUILDING MATERIALS
- A5.03 RENDERINGS
- A5.04 RENDERINGS
- A5.05 RENDERINGS
- A5.06 RENDERINGS
- A5.07 RENDERINGS
- A5.08 RENDERINGS
- A5.09 RENDERINGS
- A5.10 RENDERINGS
- A5.11 SHADOW STUDIES

- A8.01 SIGNAGE

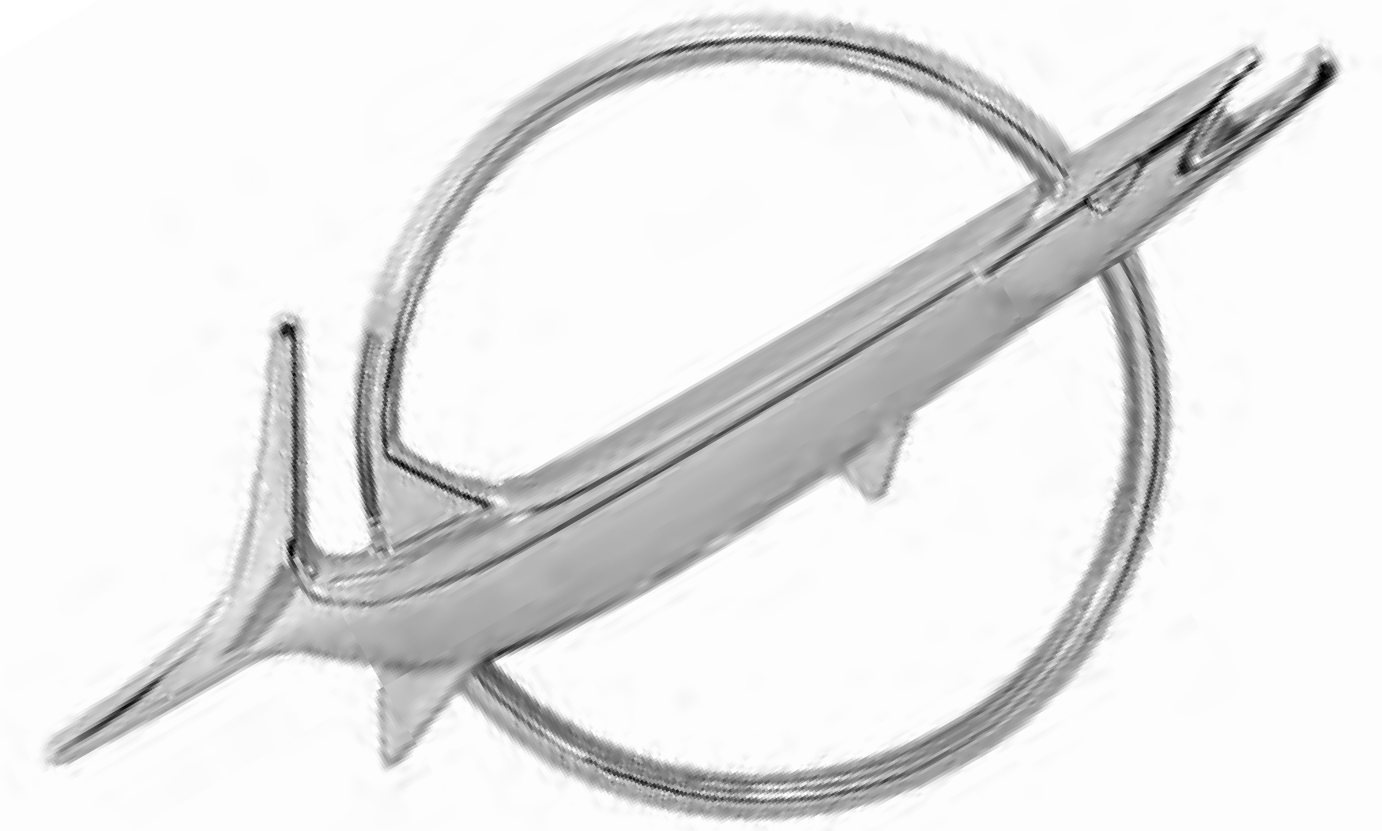

BARRACUDA

DEVELOPER
HENRY HAMILTON PARTNERS, LLC
 104 KING STREET, MADISON, WI 53703

ARCHITECT
POPULANCE, LLC
 104 KING STREET, MADISON, WI 53703

STRUCTURE
FINK/HOREJSH
 N9494 STATE ROAD 69, NEW GLARUS, WI 53574

CIVIL
D'ONOFRIO KOTTKE
 7530 WESTWARD WAY, MADISON, WI 53717

LANDSCAPE
POPULANCE, LLC
 104 KING STREET, MADISON, WI 53703

SURVEY
D'ONOFRIO KOTTKE
 7530 WESTWARD WAY, MADISON, WI 53717

ACOUSTICS
 TBD

GENERAL CONTRACTOR
 TBD

SALES
LAUER GROUP
 2229 ATWOOD AVE MADISON WI 53704

COUNSEL
REINHART BOERNER VAN DEUREN SC
 22 E MIFFLIN ST # 700, MADISON, WI 53703

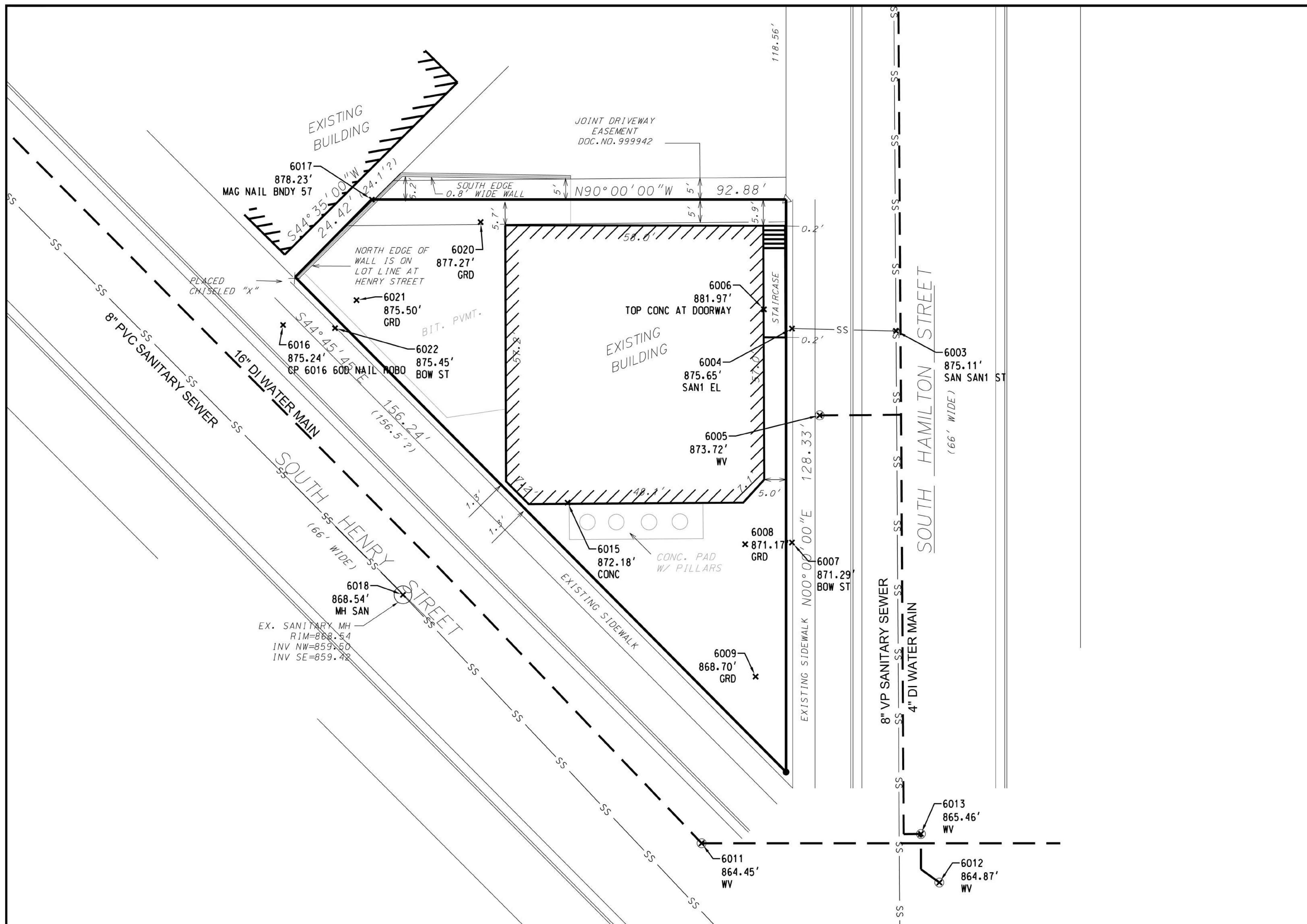

DONFRIO KOTKE AND ASSOCIATES, INC.
 7530 Westward Way, Madison, WI 53717
 Phone: 608.833.7330 • Fax: 608.833.1889
 YOUR NATURAL RESOURCE FOR LAND DEVELOPMENT

GOSCH S. HAMILTON
 222 S. HAMILTON
 MADISON, WI 53703

UTILITY PLAN

SCALE: 1" = 20'
 (PAGE SIZE: 11x17)

DATE: 03-26-18
 REVISED:

DRAWN BY: AGD
 FN: 18-02-104
 Sheet Number:
 1 of 1

UDC INFORMATIONAL

HENRY HAMILTON PARTNERS 222 S. HAMILTON MADISON, WI 53703		DATE 07.18.18
THE BARRACUDA 222 S. HAMILTON MADISON, WI 53703		SURVEY

PARCEL INFORMATION

ADDRESS
222 S. Hamilton Street

EXISTING IMPROVEMENTS
3 story steel framed and masonry office building built in 1952
Current condition is average but showing signs of deferred maintenance

CURRENT ENTRIES
Lightly used front entry at the Hamilton and Henry intersection
Side entry with stairs off Hamilton

CURRENT AUTOMOBILE PARKING
Gravel/asphalt surface lot for 6 cars. Entry off Hamilton Street via shared access easement with adjacent property

EXISTING RESIDENTIAL UNITS PROPOSED FOR DEMOLITION
0.00



HAMILTON STREET TO NORTHWEST **VIEW**



LAKE MONONA UP HAMILTON ST. **VIEW**

UDC INFORMATIONAL

HENRY HAMILTON PARTNERS
101 KING STREET
MADISON, WI 53703

DATE
07.18.18

THE BARRACUDA
222 S. HAMILTON
MADISON, WI 53703

CONTEXT

CXT.1

PROJECT CONTEXT

Project site is in an intensive urban corridor surrounded by a mixture of uses that are essential for a dynamic urban environment.

Directly east of the site is the Dane County Courthouse (2003) which provides a modern and stable backdrop to the Bassett neighborhood. during the weekday. There is a great deal of pedestrian activity at the main entrance to the Courthouse along Hamilton, however, after 5:00 pm, the amount of activity decreases substantially and the Hamilton corridor is very quiet.

West of the site is a mix of owner occupied and rental houses and new structures. These structures vary in height from 2-5 stories and date from before the turn of the 20th century to the past 15 years.

The current mix of housing options is essential to maintain a vibrant and active neighborhood and Downtown.

The massing of the existing neighborhood is perfectly aligned with the proposed project, stepping down from east to west, allowing sunlight and views to be maintained for all existing properties.

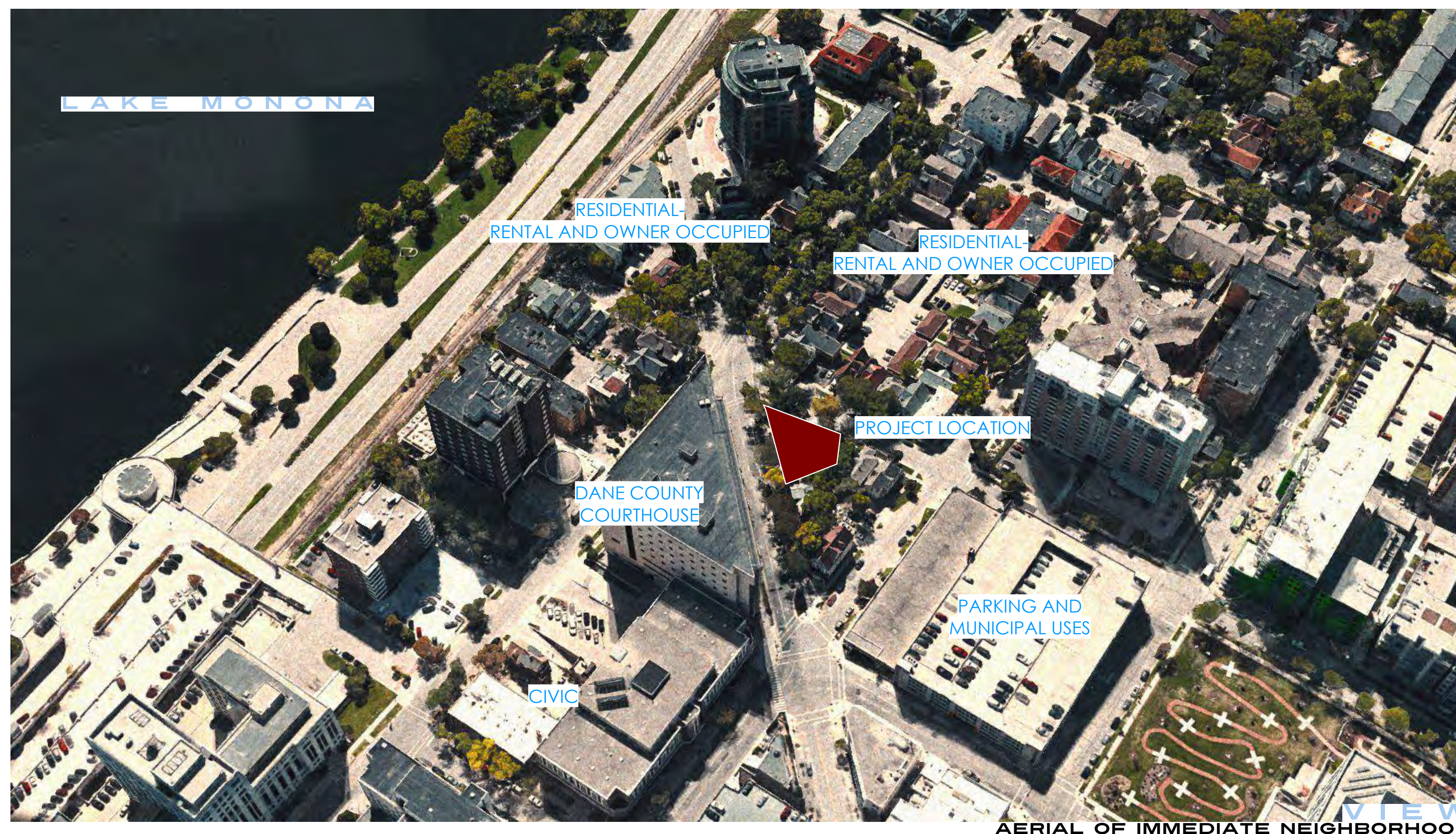

UDC INFORMATIONAL

HENRY HAMILTON PARTNERS
101 KING STREET
MADISON, WI 53703

DATE
07.18.18

THE BARRACUDA
22 S. HAMILTON
MADISON, WI 53703

CONTEXT

CXT.2

PROJECT CONTEXT

The Barracuda will strengthen the existing streetscape by eliminating voids along the existing block and create a primary pedestrian focused entry mid block at Henry Street.

The existing building is a 2 story office building dating from the early 1950s. The property has been underutilized for some time and the existing building is showing signs of decay due to deferred maintenance.

The building is currently 50% occupied with small offices housing a range of businesses. These businesses will be relocated as part of the project scope.

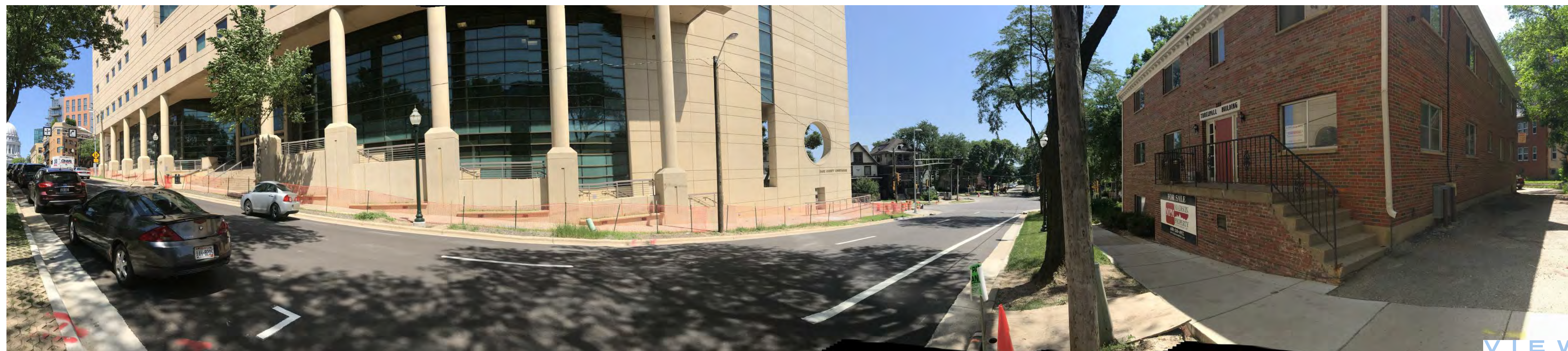

HAMILTON STREET PANORAMA



EAST SIDE OF HENRY STREET



EAST SIDE OF HENRY STREET



EAST SIDE OF HENRY STREET



WEST SIDE OF HENRY STREET

UDC INFORMATIONAL

HENRY HAMILTON PARTNERS
101 KING STREET
MADISON, WI 53703

DATE
07.18.18

THE BARRACUDA
22 S. HAMILTON
MADISON, WI 53703

CONTEXT

CXT.3



HENRY, HAMILTON, WILSON INTERSECTION



HENRY, DOTY INTERSECTION



EXISTING ALLEY AND PARKING LOT



DANE COUNTY COURTHOUSE

UDC INFORMATIONAL

HENRY HAMILTON PARTNERS
15 KING STREET
MADISON, WI 53703

DATE
07.18.18

THE BARRACUDA
222 S. HAMILTON
MADISON, WI 53703

CONTEXT

CXT.4

PROJECT CONTEXT

The Downtown Core is divided up into various allowable height allowances per MGO Section 28.071 (2)(a); Downtown Height Map

Proposed project is located in a transitional height zone which steps building heights down from the Capitol Height Limit and 10 story limits to the east to a 6 story zone.

To the west is a limit of 4 stories and to the south there is a mix of Capitol Height and 10 story parcels.

Existing buildings in the zones do not necessarily comply with the Zoning Ordinance, having been constructed prior to adoption.

The existing building heights range from 2-15 stories which creates a dynamic and varied cityscape.

The proposed project is 6 stories, which is consistent with the adopted Ordinance.

The project will contribute to the sustainable practice of urban infill and will be a contributing building to the vision of transitioning building heights in this area by perfectly aligning with the Planning vision for the City.

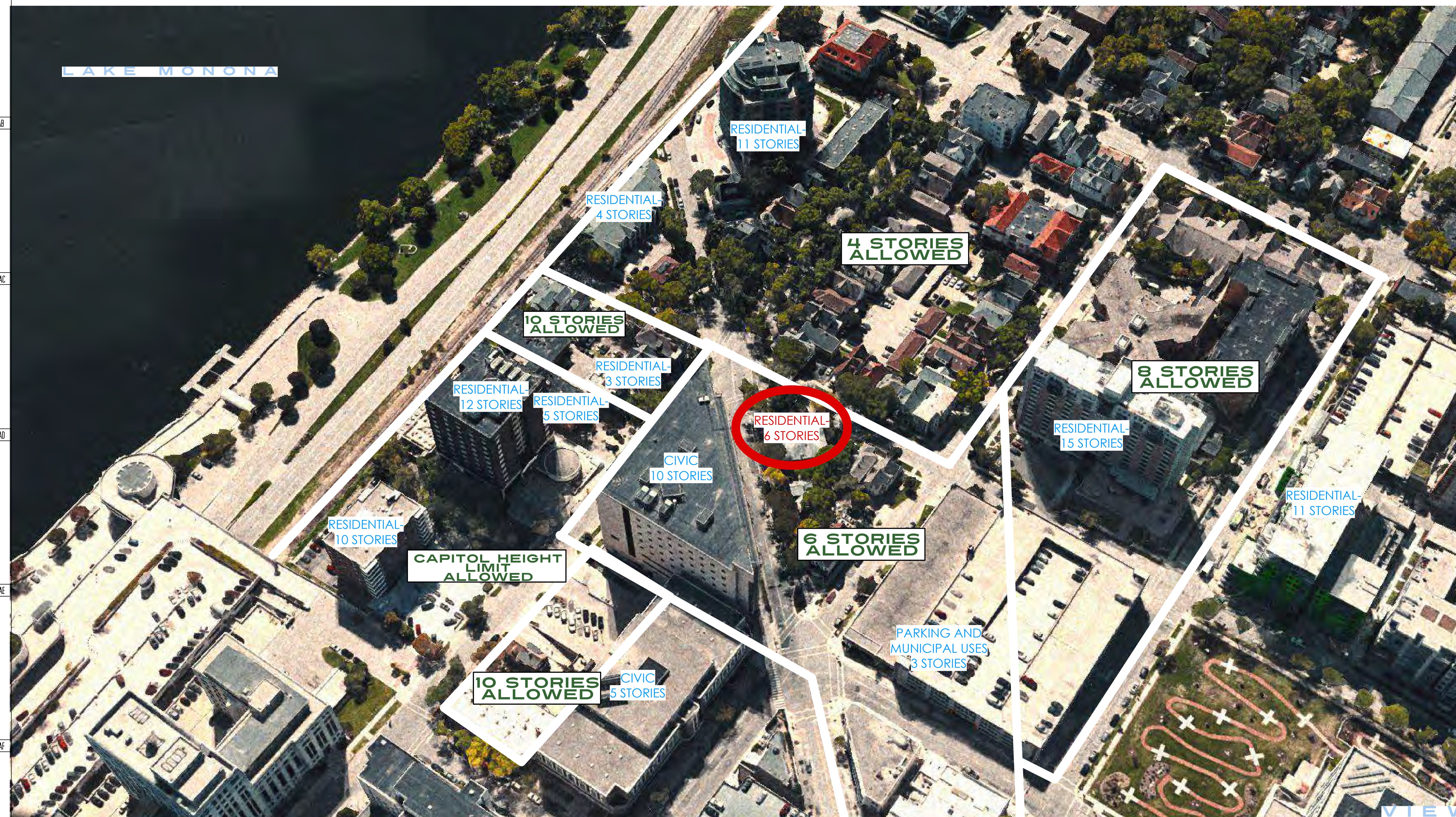

UDC INFORMATIONAL

HENRY HAMILTON PARTNERS
222 S. HAMILTON STREET
MADISON, WI 53703

DATE
07.18.18

THE BARRACUDA
222 S. HAMILTON STREET
MADISON, WI 53703

CONTEXT

CXT.5

SITE INFORMATION BLOCK

SITE ADDRESS:	222 S. HAMILTON
SITE ACREAGE (TOTAL):	0.18A
NUMBER OF BUILDING STORIES ABOVE GRADE:	6
TOTAL BUILDING SQUARE FOOTAGE:	44,287 S.F.
USE OF PROPERTY:	MIXED USE; OFFICE AND 19 CONDO UNITS
NUMBER OF PARKING STALLS:	19
TOTAL SITE AREA:	7840 S.F.
EXISTING PAVEMENT IMPERVIOUS AREA:	2139 S.F.
EXISTING BUILDING IMPERVIOUS AREA:	4099 S.F.
TOTAL EXISTING IMPERVIOUS AREA:	6238 S.F.
TOTAL EXISTING PERVIOUS AREA:	1602 S.F.
PROPOSED PAVEMENT IMPERVIOUS AREA:	365 S.F.
PROPOSED BUILDING IMPERVIOUS AREA:	6247 S.F.
TOTAL PROPOSED IMPERVIOUS AREA:	6612 S.F.
TOTAL PROPOSED PERVIOUS AREA:	1228 S.F.

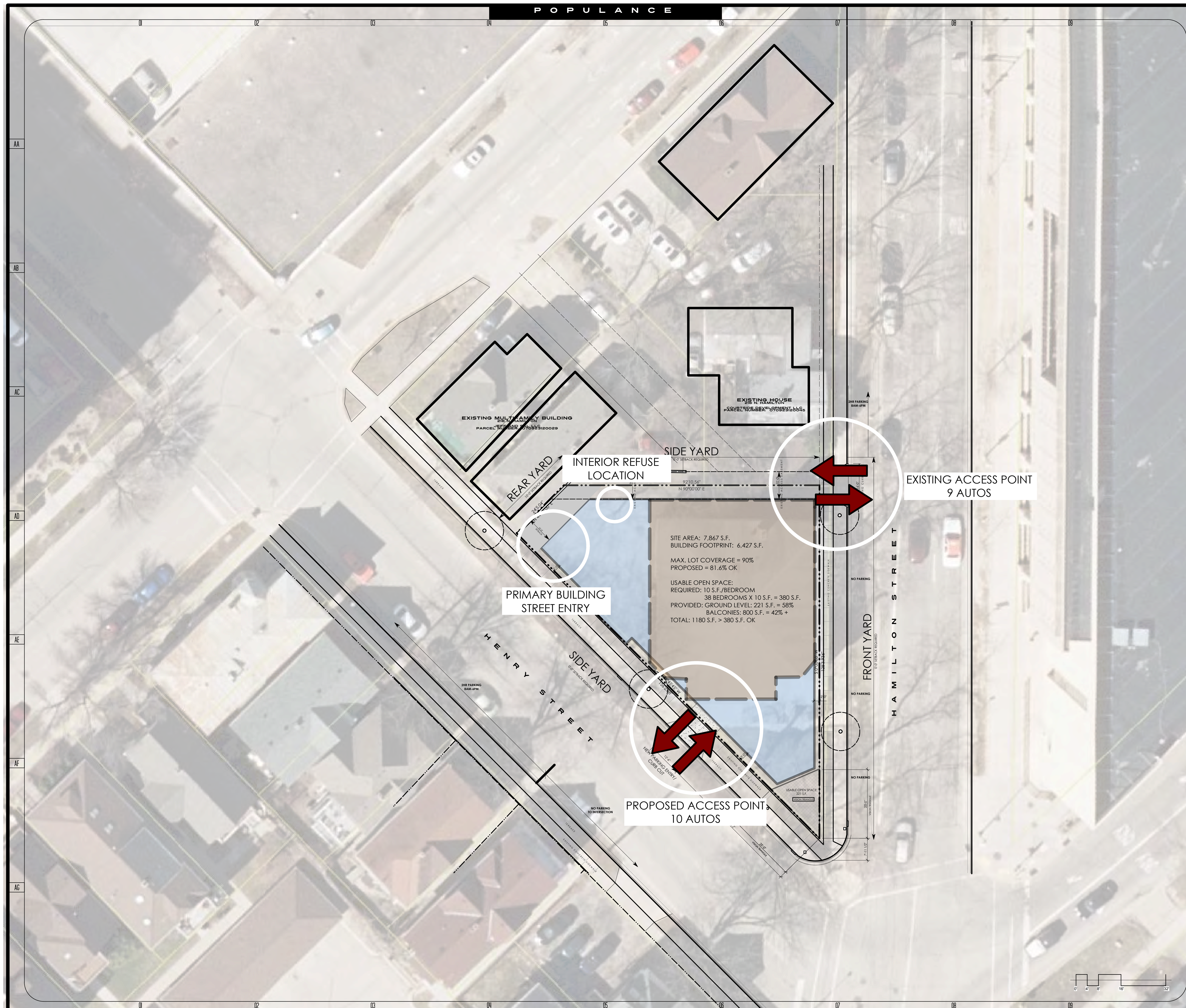

UDC INFORMATIONAL

HENRY HAMILTON PARTNERS
101 KING STREET
MADISON, WI 53703

DATE
07.18.18

THE BARRACUDA
222 S. HAMILTON
MADISON, WI 53703

CO.01

OVERALL SITE PLAN

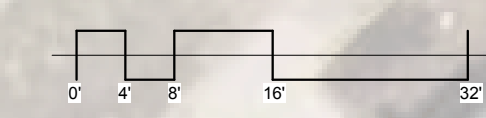

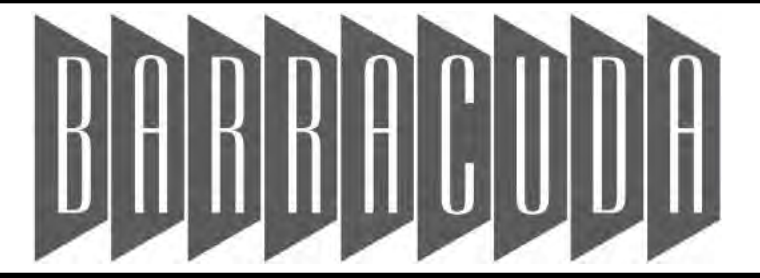
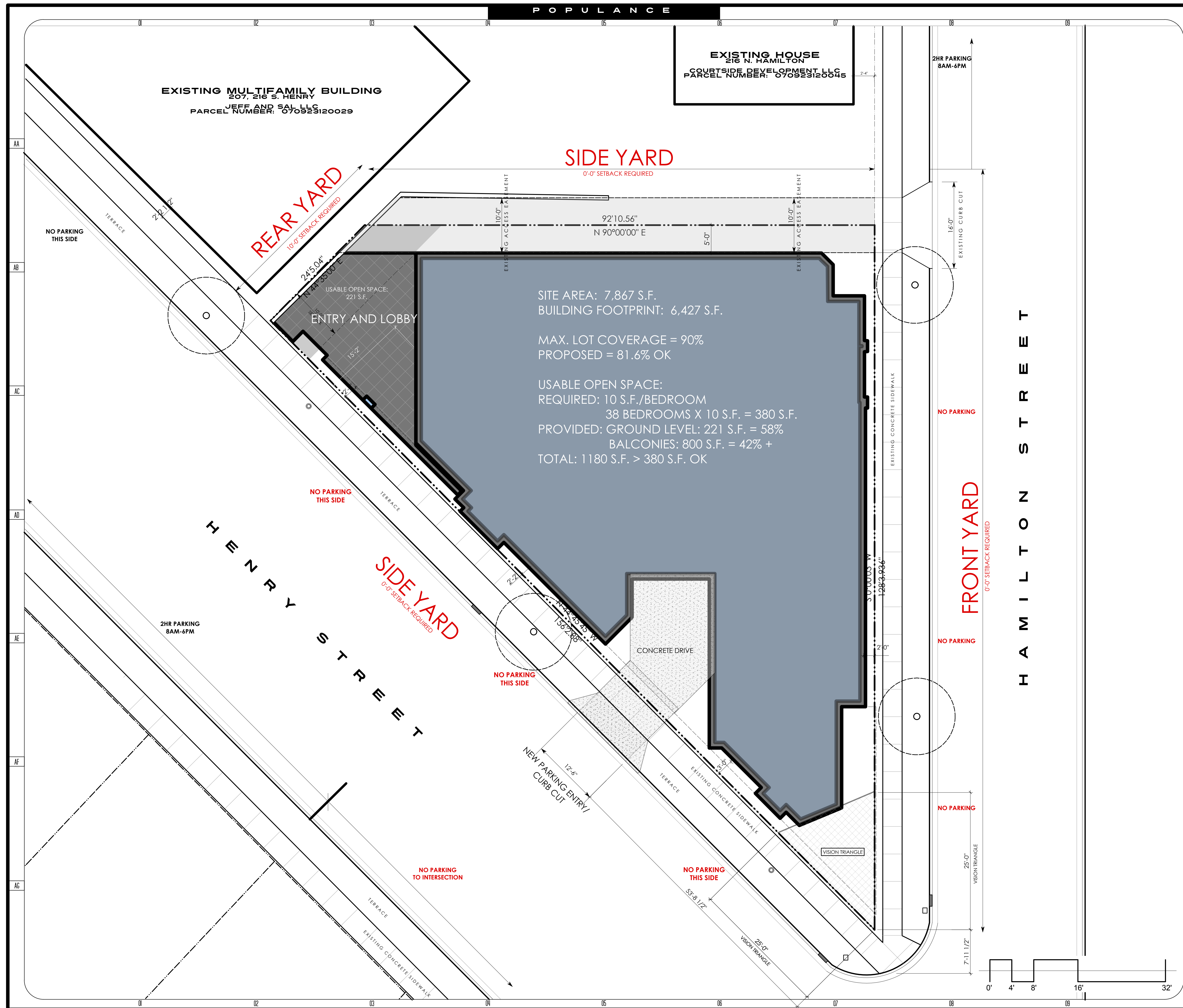

GENERAL NOTES

28.140 USABLE OPEN SPACE.
 Rev. 12/15/16
 28 - 170
 (1) Usable open space shall be provided on each lot used in whole or in part for residential purposes, as set forth in each district.
 (a) Usable open space at ground level shall be in a compact area of not less than two hundred (200) square feet, with no dimension less than eight (8) feet and no slope grade greater than ten percent (10%).
 1. Where lot width is less than forty (40) feet, the minimum dimension of usable open space may be reduced to six (6) feet.
 (b) Usable open space shall not include areas occupied by buildings, driveways, drive aisles, off-street parking, paving and sidewalks, except that paved paths no wider than five (5) feet, and previous pavement designed for outdoor recreation only may be included as usable open space.
 (c) Within the Central Area, as defined, where usable open space requirements cannot be met due to limited existing lot area, or building/parking placement, required landscaped areas may be used to meet the usable open space requirement, provided that said landscaped areas are a minimum of five (5) feet in width.
 (d) Within the TR-41 and TR-42 Districts and within all Mixed-Use, Employment, Downtown and Urban Districts:
 1. Roof decks, porches, and balconies may be used to meet up to seventy-five percent (75%) of the minimum open space requirements, provided that:
 a. Roof decks shall have a minimum dimension of fifteen (15) feet and shall be free of any obstructions, improved and available for safe and convenient access to all occupants of the building.
 b. Porches shall have a minimum width of fifteen (15) feet and minimum depth of six (6) feet and shall be free of any obstructions, improved, and available to all occupants as a source of ingress and egress to the building.
 c. Balconies shall have a minimum dimension of six (6) feet and shall be free of any obstructions, improved, and available for safe and convenient access to all occupants of the building.
 d. Private balconies and private porches shall have a minimum dimension of four and one-half (4 1/2) feet.
 (Am. by ORD-16-00107, 12-14-16)
 (e) Within the TSS and MXC Districts, roof decks and balconies may be used to meet up to one hundred percent (100%) of the minimum open space requirements, provided that the dimensions set forth in sub. (d) 1. and 2 are met. (Cr. by ORD-14-00148, 9-12-14; ORD-16-00039, 4-8-16)

Urban Mixed-Use District	
Lot area (sq. ft.)	3,000
Lot width	30
Minimum front yard setback	Nonresidential or mixed-use buildings: 0 Residential buildings: 5 See (a) below
Maximum front yard setback	See (a) below
Side yard setback	10
Rear yard setback	0 See (b) below
Maximum lot coverage	90%
Minimum height	2 Stories
Maximum height	See Downtown Height Map
Stepback	See Downtown Stepback Map
Usable open space	10 sq. ft. per bedroom See (c) below

- (a) Specific front yard setbacks may be designated on the zoning map and may be designated as a specific location (build to line), a minimum, or a range.
- (b) Underground parking may extend into the rear yard setback if located completely below grade.
- (c) Usable open space may take the form of at-grade open space, porches, balconies, roof decks, green roofs or other above-ground amenities.

SETBACKS AT EXISTING BUILDINGS

- FROM PRIMARY STREET
- RESIDENTIAL ACROSS HENRY
- 202 S. HENRY ST. = 0'-0" N, 6" E
 - 206 S. HENRY ST. = 2'-10"
 - 208 S. HENRY ST. = 3'-1"
 - 212 S. HENRY ST. = 3'-6"
 - 216 S. HENRY ST. = 1'-4"
 - 302 W. WILSON ST. = 5'-1"
- RESIDENTIAL ON SAME BLOCK
- 203 S. HENRY ST. = 1'-1"
 - 207 S. HENRY ST. = 2'-3"
 - 206 S. HAMILTON ST. = 1'-1"
 - 216 S. HAMILTON ST. = 4'-8"
- CIVIC ACROSS HENRY (COURTHOUSE)
- 124 W. WILSON ST. = 0'-0"

AVERAGE SETBACK: 2'-2"

UDC INFORMATIONAL

HENRY HAMILTON PARTNER MADISON, WI 53703		DATE
		07.18.18
THE BARRACUDA MADISON, WI 53703		CO.02
ZONING ANALYSIS		
SCALE 1/8" = 1'-0"		

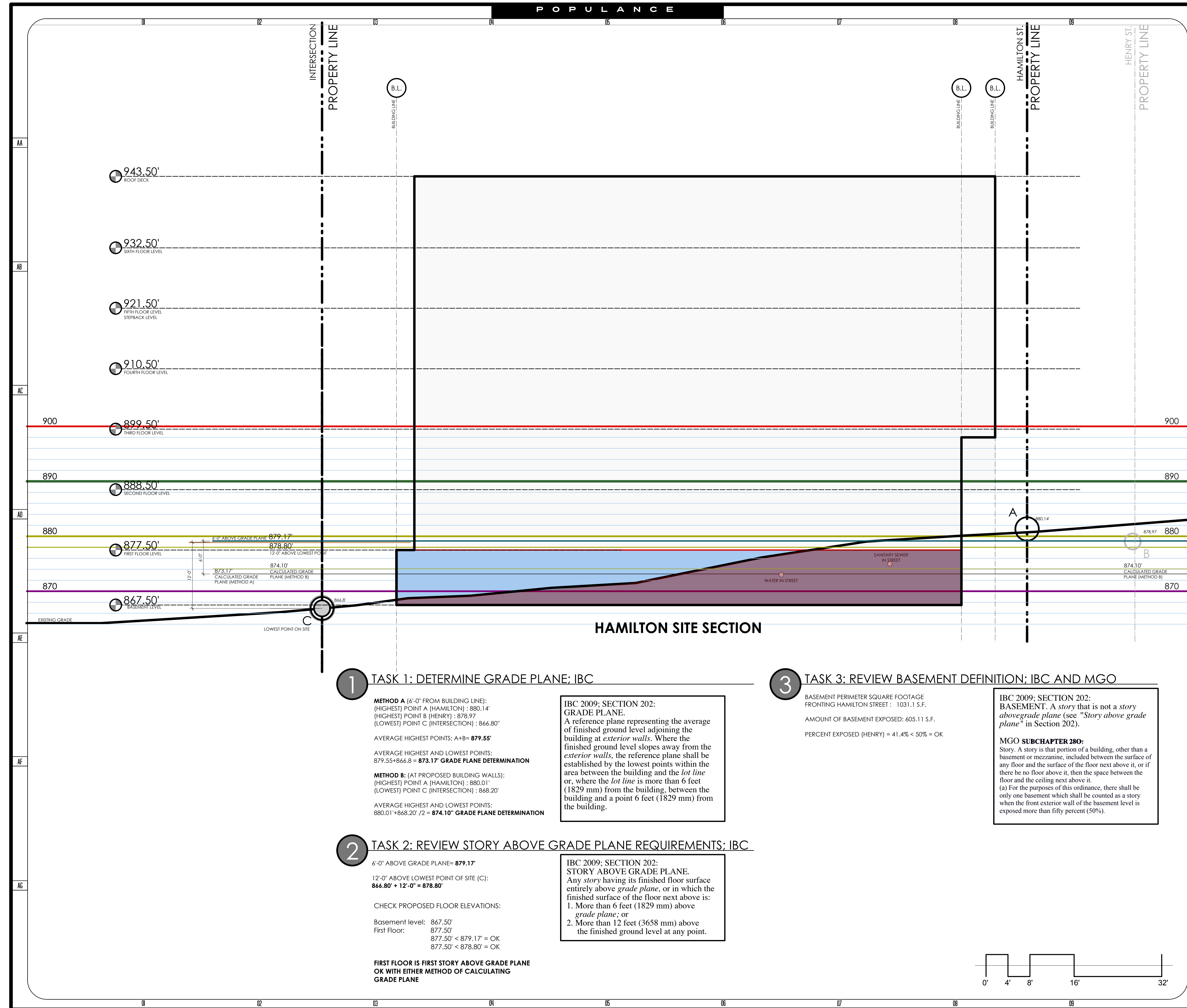

HAMILTON SITE SECTION

1 TASK 1: DETERMINE GRADE PLANE; IBC

METHOD A (6'-0" FROM BUILDING LINE):
(HIGHEST) POINT A (HAMILTON) : 880.14'
(HIGHEST) POINT B (HENRY) : 878.97'
(LOWEST) POINT C (INTERSECTION) : 866.80'

AVERAGE HIGHEST POINTS: A+B= 879.55'

AVERAGE HIGHEST AND LOWEST POINTS:
879.55+866.8 = **873.17' GRADE PLANE DETERMINATION**

METHOD B: (AT PROPOSED BUILDING WALLS):
(HIGHEST) POINT A (HAMILTON) : 880.01'
(LOWEST) POINT C (INTERSECTION) : 868.20'

AVERAGE HIGHEST AND LOWEST POINTS:
880.01+868.20' / 2 = **874.10' GRADE PLANE DETERMINATION**

IBC 2009; SECTION 202:
GRADE PLANE.
A reference plane representing the average of finished ground level adjoining the building at exterior walls. Where the finished ground level slopes away from the exterior walls, the reference plane shall be established by the lowest points within the area between the building and the lot line or, where the lot line is more than 6 feet (1829 mm) from the building, between the building and a point 6 feet (1829 mm) from the building.

2 TASK 2: REVIEW STORY ABOVE GRADE PLANE REQUIREMENTS; IBC

6'-0" ABOVE GRADE PLANE = 879.17'
12'-0" ABOVE LOWEST POINT OF SITE (C):
866.80' + 12'-0" = 878.80'

CHECK PROPOSED FLOOR ELEVATIONS:

Basement level: 867.50'
First Floor: 877.50'
877.50' < 879.17' = OK
877.50' < 878.80' = OK

IBC 2009; SECTION 202:
STORY ABOVE GRADE PLANE.
Any story having its finished floor surface entirely above grade plane, or in which the finished surface of the floor next above is:
1. More than 6 feet (1829 mm) above grade plane; or
2. More than 12 feet (3658 mm) above the finished ground level at any point.

FIRST FLOOR IS FIRST STORY ABOVE GRADE PLANE
OK WITH EITHER METHOD OF CALCULATING GRADE PLANE

3 TASK 3: REVIEW BASEMENT DEFINITION; IBC AND MGO

BASEMENT PERIMETER SQUARE FOOTAGE
FRONTING HAMILTON STREET : 1031.1 S.F.
AMOUNT OF BASEMENT EXPOSED: 605.11 S.F.
PERCENT EXPOSED (HENRY) = 41.4% < 50% = OK

IBC 2009; SECTION 202:
BASEMENT. A story that is not a story above grade plane (see "Story above grade plane" in Section 202).

MGO SUBCHAPTER 280:
Story. A story is that portion of a building, other than a basement or mezzanine, included between the surface of any floor and the surface of the floor next above it, or if there be no floor above it, then the space between the floor and the ceiling next above it.
(a) For the purposes of this ordinance, there shall be only one basement which shall be counted as a story when the front exterior wall of the basement level is exposed more than fifty percent (50%).

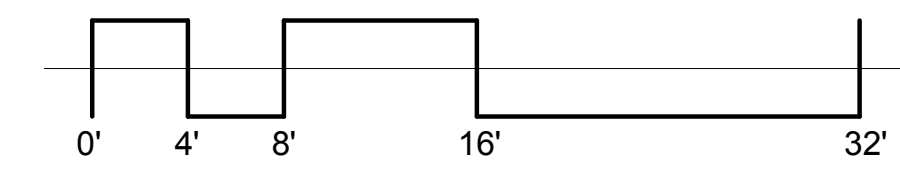

DATE	DESCRIPTION

UDC INFORMATIONAL

HENRY HAMILTON PARTNERS 222 S. HAMILTON STREET MADISON, WI 53703		DATE 07.18.18
THE BARRACUDA 222 S. HAMILTON STREET MADISON, WI 53703		CO.04
SITE SECTION AND GRADE PLANE SCALE 1/8" = 1'-0"		

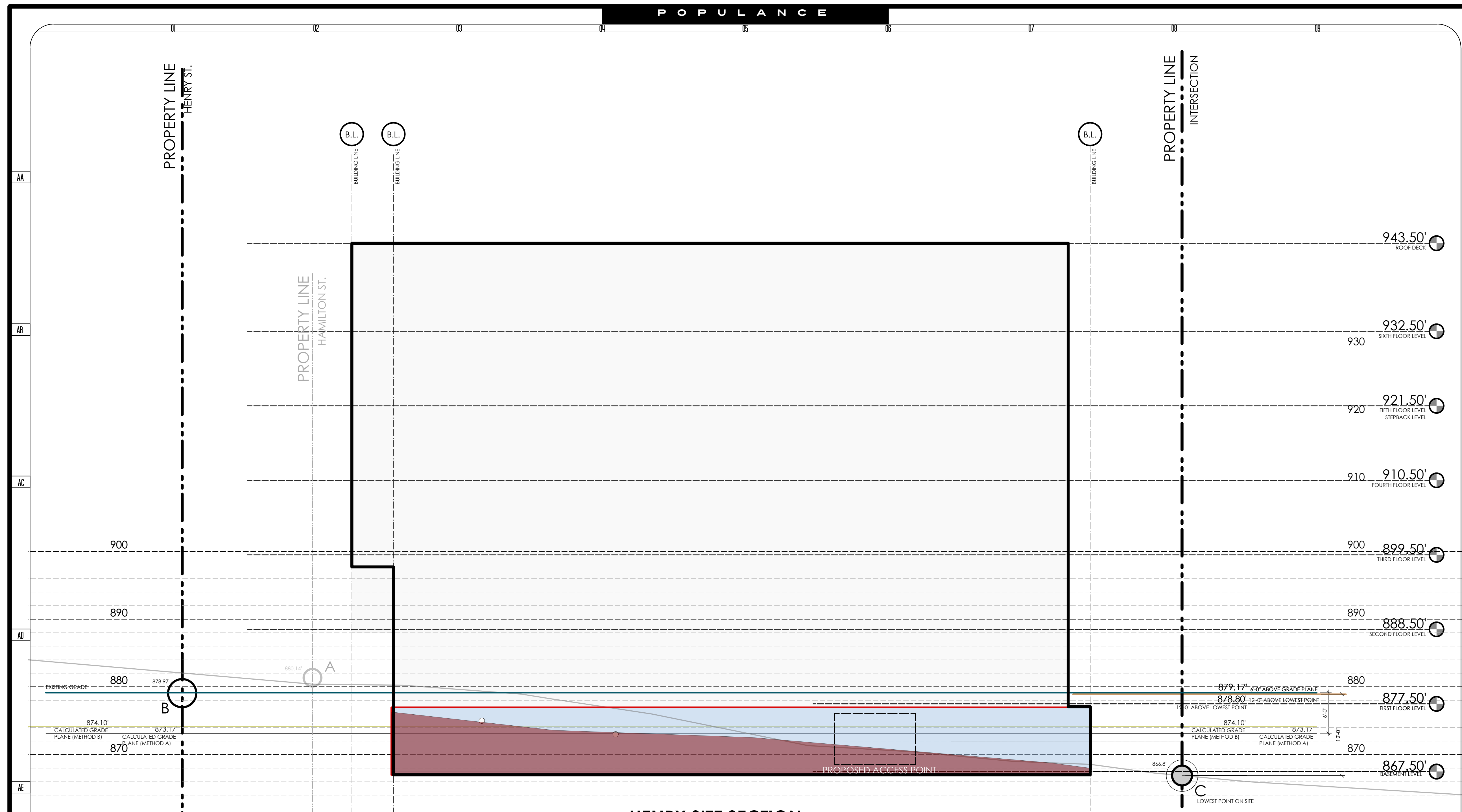

HENRY SITE SECTION

1 TASK 1: DETERMINE GRADE PLANE; IBC

METHOD A (6'-0" FROM BUILDING LINE):
 (HIGHEST) POINT A (HAMILTON) : 880.14'
 (HIGHEST) POINT B (HENRY) : 878.97'
 (LOWEST) POINT C (INTERSECTION) : 866.80"

AVERAGE HIGHEST POINTS: A+B = 879.55'

AVERAGE HIGHEST AND LOWEST POINTS:
 879.55 + 866.8 = 873.17' GRADE PLANE DETERMINATION

METHOD B: (AT PROPOSED BUILDING WALLS):
 (HIGHEST) POINT A (HAMILTON) : 880.01'
 (LOWEST) POINT C (INTERSECTION) : 868.20"

AVERAGE HIGHEST AND LOWEST POINTS:
 880.01 + 868.20 / 2 = 874.10' GRADE PLANE DETERMINATION

IBC 2009; SECTION 202:
 GRADE PLANE.
 A reference plane representing the average of finished ground level adjoining the building at exterior walls. Where the finished ground level slopes away from the exterior walls, the reference plane shall be established by the lowest points within the area between the building and the lot line or, where the lot line is more than 6 feet (1829 mm) from the building, between the building and a point 6 feet (1829 mm) from the building.

2 TASK 2: REVIEW STORY ABOVE GRADE PLANE REQUIREMENTS; IBC

6'-0" ABOVE GRADE PLANE = 879.17'

12'-0" ABOVE LOWEST POINT OF SITE (C):
 866.80' + 12'-0" = 878.80'

CHECK PROPOSED FLOOR ELEVATIONS:

Basement level: 867.50'
 First Floor: 877.50'
 877.50' < 879.17' = OK
 877.50' < 878.80' = OK

FIRST FLOOR IS FIRST STORY ABOVE GRADE PLANE
 OK WITH EITHER METHOD OF CALCULATING
 GRADE PLANE

IBC 2009; SECTION 202:
 STORY ABOVE GRADE PLANE.
 Any story having its finished floor surface entirely above grade plane, or in which the finished surface of the floor next above is:
 1. More than 6 feet (1829 mm) above grade plane; or
 2. More than 12 feet (3658 mm) above the finished ground level at any point.

3 TASK 3: REVIEW BASEMENT DEFINITION; IBC AND MGO

BASEMENT PERIMETER SQUARE FOOTAGE
 FRONTING HENRY STREET : 1031.1 S.F.
 AMOUNT OF BASEMENT EXPOSED: 537.7 S.F.
 PERCENT EXPOSED (HENRY) = 48% < 50% = OK

IBC 2009; SECTION 202:
 BASEMENT. A story that is not a story abovegrade plane (see "Story above grade plane" in Section 202).

MGO SUBCHAPTER 280:
 Story. A story is that portion of a building, other than a basement or mezzanine, included between the surface of any floor and the surface of the floor next above it, or if there be no floor above it, then the space between the floor and the ceiling next above it.
 (a) For the purposes of this ordinance, there shall be only one basement which shall be counted as a story when the front exterior wall of the basement level is exposed more than fifty percent (50%).

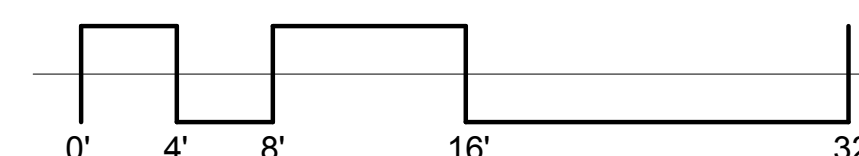

DATE	DESCRIPTION

UDC INFORMATIONAL

HENRY HAMILTON PARTNERS
 225 N. HAMILTON STREET
 MADISON, WI 53703

DATE
 07.18.18

THE BARRACUDA
 225 N. HAMILTON STREET
 MADISON, WI 53703

CO.05

SITE SECTION AND GRADE PLANE DETERMINATION- HENRY ST.
 SCALE 1/8" = 1'-0"

DANE COUNTY COURTHOUSE

BARRACUDA

15'-0"
STEPBACK
MGO
28.071(2)(c)
Downtown
Stepback
Map

4 STORIES

RESIDENTIAL

S. HENRY STREET

ENTRY LOBBY

PARKING

S. HAMILTON STREET

PARKING

SITE SECTION

DATE	DESCRIPTION

UDC INFORMATIONAL

HENRY HAMILTON PARTNERS
225 S. HAMILTON STREET
MADISON, WI 53703

THE BARRACUDA
225 S. HAMILTON STREET
MADISON, WI 53703

DATE
07.18.18

CO.06

SITE SECTION THROUGH HENRY AND HAMILTON STREETS

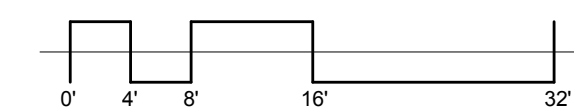

GENERAL NOTES

- 1: ALL EXISTING STREET TREES TO BE PROTECTED
- 2: CONTRACTOR SHALL INSTALL TREE PROTECTION FENCING IN THE AREA BETWEEN THE CURB AND SIDEWALK AND EXTEND IT AT LEAST 5 FEET FROM BOTH SIDES OF THE TREE ALONG THE LENGTH OF THE TERRACE.
- NO EXCAVATION IS PERMITTED WITHIN 5 FEET OF THE OUTSIDE EDGE OF A TREE TRUNK. IF EXCAVATION WITHIN 5 FEET OF ANY TREE IS NECESSARY, CONTRACTOR SHALL CONTACT CITY FORESTRY (266-4816) PRIOR TO EXCAVATION TO ASSESS THE IMPACT TO THE TREE AND ROOT SYSTEM.
- TREE PRUNING SHALL BE COORDINATED WITH CITY FORESTRY PRIOR TO THE START OF CONSTRUCTION. TREE PROTECTION SPECIFICATIONS CAN BE FOUND IN SECTION 107.13 OF CITY OF MADISON STANDARD SPECIFICATIONS FOR PUBLIC WORKS CONSTRUCTION [HTTP://WWW.CITYOFMADISON.COM/BUSINESS/PW/DOCUMENTS/STDSPCS/2018/PART1.PDF](http://www.cityofmadison.com/BUSINESS/PW/DOCUMENTS/STDSPCS/2018/PART1.PDF)
- ANY TREE REMOVALS THAT ARE REQUIRED FOR CONSTRUCTION AFTER THE DEVELOPMENT PLAN IS APPROVED WILL REQUIRE AT LEAST A 72 HOUR WAIT PERIOD BEFORE A TREE REMOVAL PERMIT CAN BE ISSUED BY FORESTRY, TO NOTIFY THE ALDER OF THE CHANGE IN THE TREE PLAN.
- 3: ADDITIONAL STREET TREES ARE NEEDED FOR THIS PROJECT. ALL STREET TREE PLANTING LOCATIONS AND TREES SPECIES WITHIN THE RIGHT OF WAY SHALL BE DETERMINED BY CITY FORESTRY. PLEASE SUBMIT A SITE PLAN (IN PDF FORMAT) TO BRAD HOFMANN - BFHOFMANN@CITYOFMADISON.COM OR 266-4816. TREE PLANTING SPECIFICATIONS CAN BE FOUND IN SECTION 209 OF CITY OF MADISON STANDARD SPECIFICATIONS FOR PUBLIC WORKS CONSTRUCTION
- 4: NO BUILDING AS DEFINED IN SEC. 29.03, MGO, SHALL BE DEMOLISHED OR REMOVED WITHOUT A PERMIT FROM THE BUILDING INSPECTION DIVISION OF THE DEPARTMENT OF PLANNING AND COMMUNITY AND ECONOMIC DEVELOPMENT.

DRAWING NOTES

- 1: EXISTING SIDEWALKS TO REMAIN- REPAIR AS NEEDED

CODE NOTES

DATE	DESCRIPTION

UDC INFORMATIONAL

HENRY HAMILTON PARTNERS 222 S. HAMILTON STREET MADISON, WI 53703		DATE 07.18.18
THE BARRACUDA 222 S. HAMILTON STREET MADISON, WI 53703		C1.01
SITING DEMOLITION PLAN SCALE 1/8" = 1'-0"		

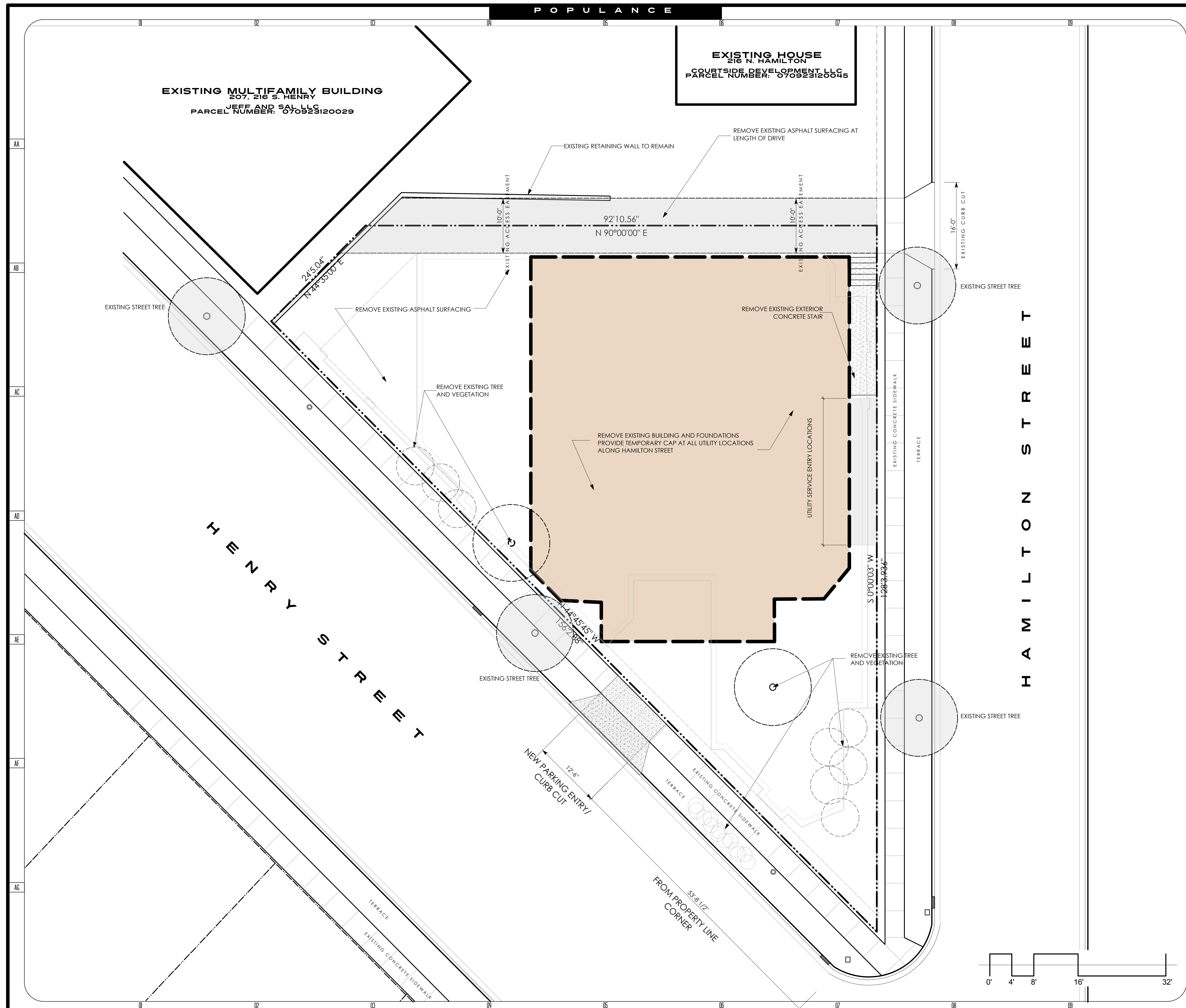

EXTERIOR PHOTOS OF EXISTING BUILDING



SITE PARKING



BUILDING ENTRY



BUILDING ENTRY



BUILDING ENTRY



HAMILTON STREET



ENTRY STAIR



TYPICAL WINDOW



BUILDING ENTRY

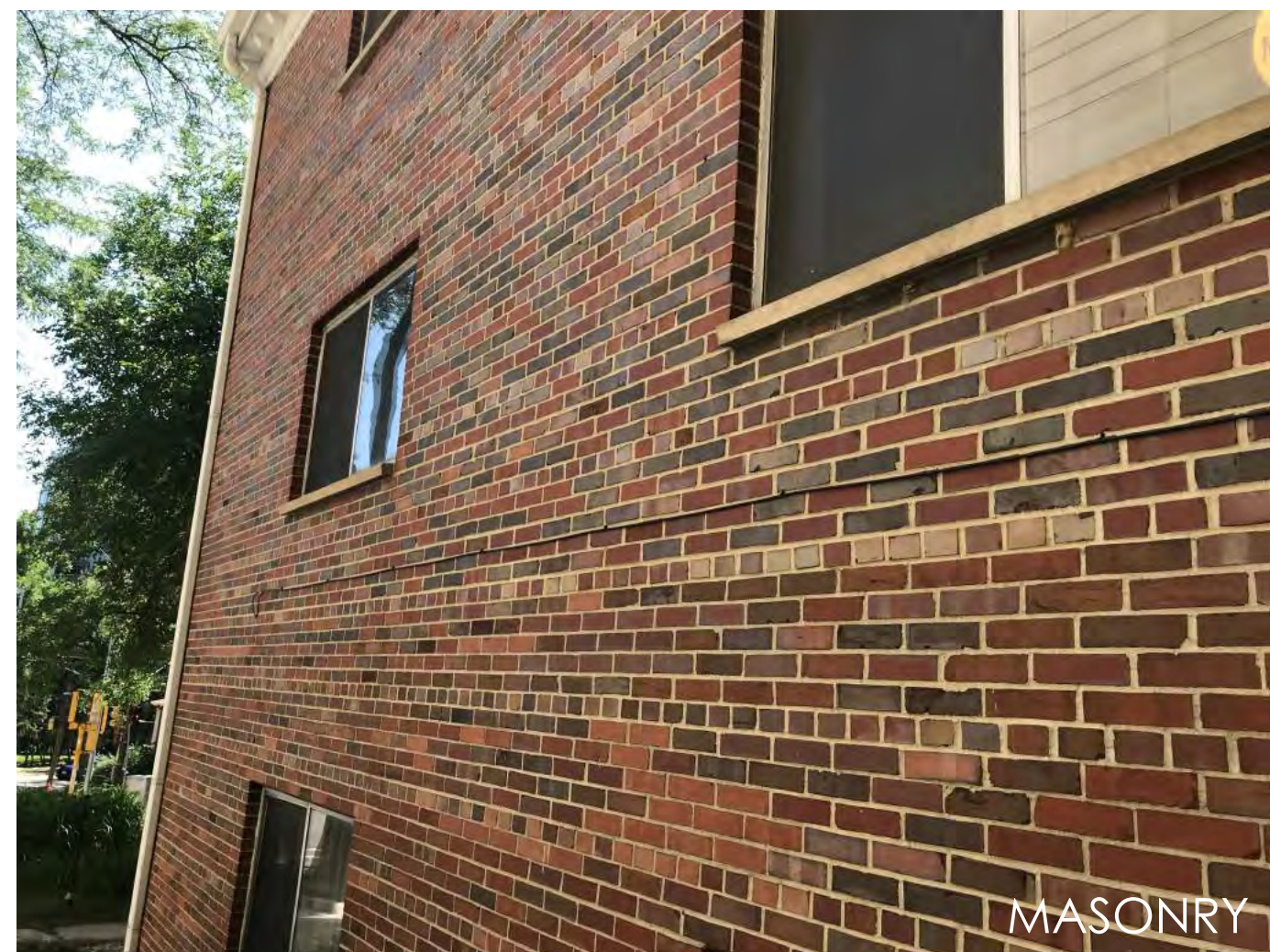

MASONRY



GENERAL NOTES

EXISTING STRUCTURE WAS BUILT IN 1955 FOR USE AS AN OFFICE BUILDING.

BUILDING STYLE IS APPROXIMATING A SEMI-GEORGIAN REVIVAL WITH SEVERAL ELEMENTS, INCLUDING COLUMNS AND A PEDIMENT AT THE FRONT ENTRY.

THE WINDOWS AND ARTICULATION OF THE REST OF THE ELEVATIONS DO NOT CARRY OVER ANY OF THE DESIGN LANGUAGE AND ARE FLAT SURFACES WITH LITTLE TO NO ARCHITECTURAL DETAIL.

THE CASEMENT WINDOWS ARE ANOTHER DEVIATION FROM THE FAUX GEORGIAN STYLE SEEN AT THE ENTRY ELEVATION. IT IS ASSUMED THAT THOSE ARE NOT THE ORIGINAL WINDOWS, BUT NO INFORMATION COULD BE FOUND AS TO A REPLACEMENT DATE.

THE BUILDING IS SYMMETRICAL ABOUT AN AXIS ON SITE THAT IS SKEWED SOMEWHERE BETWEEN THE HAMILTON AND HENRY STREET AXES THAT CREATES AN UNUSUAL MAIN ENTRY FACADE THAT IS NOT DIRECTLY RELATED TO EITHER STREET.

THE BUILDING IS SUBDIVIDED UP INTO OFFICES SERVED BY A DOUBLE LOADED CORRIDOR AND OPEN STAIRS SERVING ALL LEVELS.

THE STRUCTURE CONSISTS OF CONCRETE FOUNDATION WALLS, STEEL FRAMING FOR THE FIRST AND SECOND FLOORS (APPROX. 22'-0" BAY SPACING) AND WOOD ROOF TRUSSES.

FLOOR SYSTEMS APPEAR TO BE A COMPOSITE CONCRETE DECK WITH A COMBINATION OF CARPET AND TERRAZZO FLOOR FINISHES IN THE COMMON AREAS AND CORRIDORS AND CARPET IN THE OFFICES.

BATHROOMS RECEIVED A CERAMIC TILE FINISH.

THE STRUCTURE IS IN RELATIVELY GOOD SHAPE, WITH SIGNS OF DEFERRED MAINTENANCE APPEARING. SEVERAL AREAS OF THE EXTERIOR BRICK CLADDING WOULD BE CANDIDATES FOR RE-POINTING, BUT NO MAJOR WATER INFILTRATION WAS EVIDENT DURING THE INSPECTION.

THE ASPHALT SHINGLE ROOF APPEARS TO BE 15+ YEARS OLD AND WOULD NEED TO BE REPLACED IN THE MEDIUM TERM. NO VISIBLE SIGNS OF WATER INFILTRATION OR DAMAGE WERE EVIDENT.

UDC INFORMATIONAL

HENRY HAMILTON PARTNERS
22 S. HAMILTON STREET
MADISON, WI 53703

DATE
07.18.18

THE BARRACUDA
22 S. HAMILTON
MADISON, WI 53703

C1.02

EXTERIOR BUILDING PHOTOS

INTERIOR PHOTOS OF EXISTING BUILDING



GENERAL NOTES

AS IS COMMON WITH BUILDINGS OF THIS AGE, THERE ARE NO ACCESSIBLE ROUTES FROM THE SIDEWALK OR PARKING ARE TO ANY LEVEL OF THE BUILDING, WITH OBSTRUCTIONS, CURBS, AND STAIRS PREVENTING ANY ACCESSIBLE ACCESS.

IN ADDITION TO THE LACK OF ACCESSIBLE ROUTES, THERE IS NO ELEVATOR SERVING THE DIFFERENT BUILDING FLOORS. THE PUBLIC BATHROOMS ARE SITUATED SUCH THAT THERE IS ONE BATHROOM PER FLOOR.

THE WOMEN'S RESTROOM IS ON THE 2ND FLOOR, THE MEN'S BATHROOM IS ON THE 1ST FLOOR, AND THERE ARE NO RESTROOMS ON THE BASEMENT LEVEL.

THE BATHROOMS PROVIDE MINIMAL TO NO MANEUVERING CLEARANCES AND NONE MEET THE MINIMAL ACCESSIBLE DESIGN STANDARD REQUIREMENTS OF TODAY.

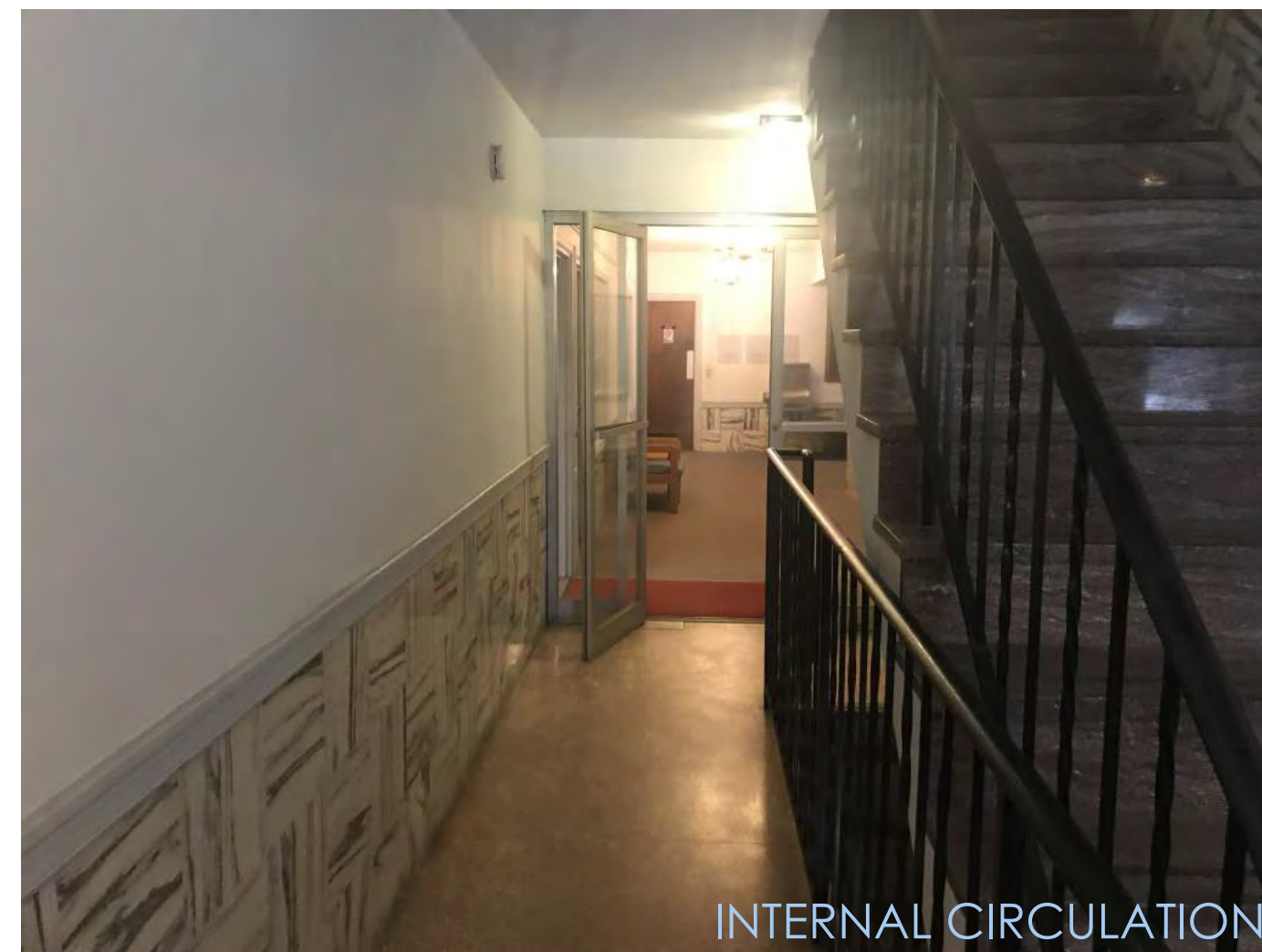

INTERNAL CIRCULATION



TYPICAL OFFICE



1ST FLOOR CORRIDOR



MAIN ENTRY

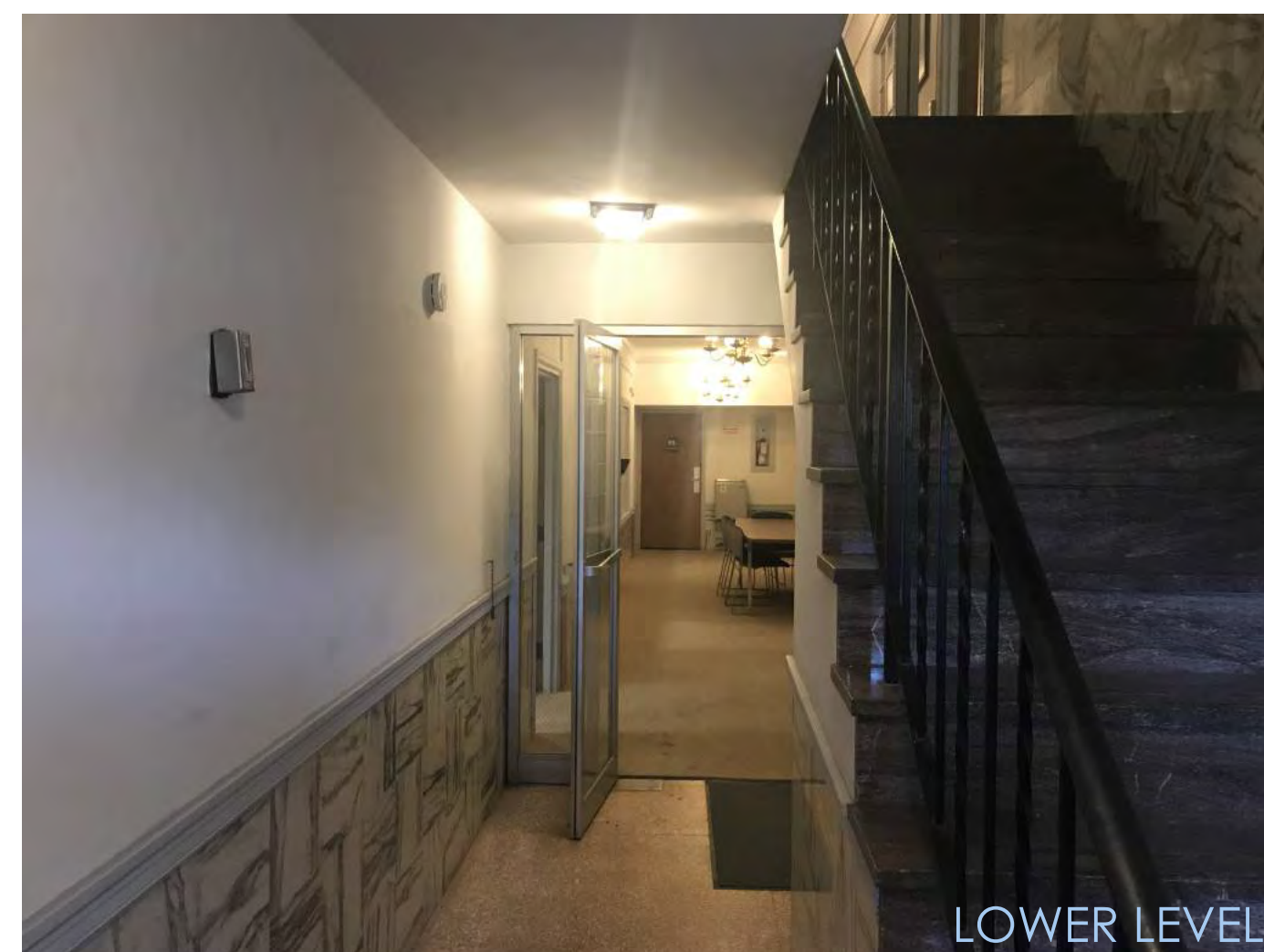

LOWER LEVEL



2ND FLOOR CORRIDOR



TYPICAL BATHROOM

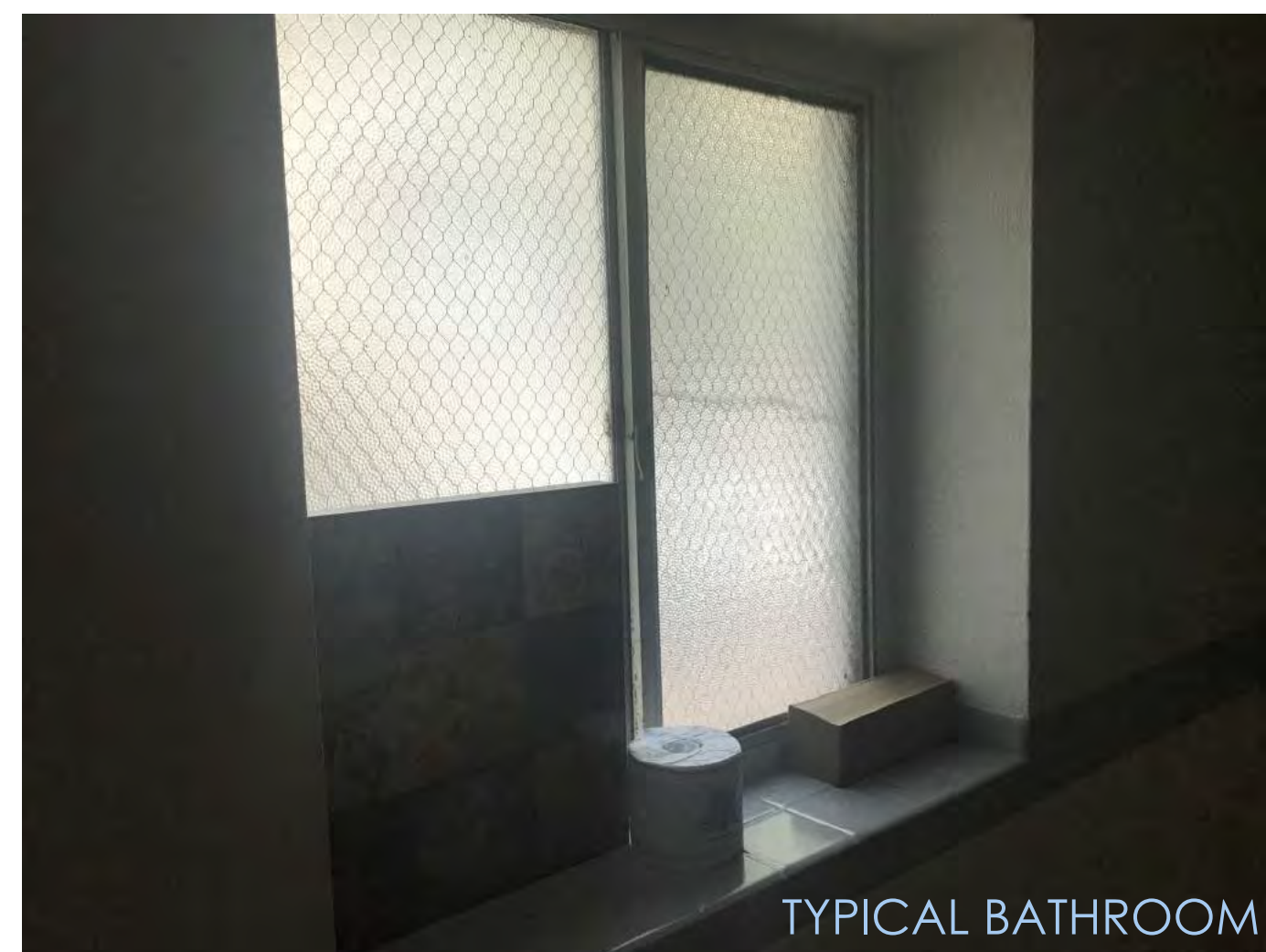

TYPICAL BATHROOM



STAIR TO BASEMENT

UDC INFORMATIONAL

HENRY HAMILTON PARTNERS
10 KING STREET
MADISON, WI 53703

DATE

07.18.18

THE BARRACUDA
222 S. HAMILTON
MADISON, WI 53703

C1.03

INTERIOR BUILDING PHOTOS



GENERAL NOTES

EROSION CONTROL NOTES

- (1) THE CONTRACTOR SHALL IMPLEMENT AND MAINTAIN EROSION CONTROL DEVICES FROM THE START OF LAND DISTURBING CONSTRUCTION ACTIVITIES UNTIL FINAL STABILIZATION OF THE CONSTRUCTION SITE.
- (2) ALL EROSION CONTROL MEASURES SHALL BE INSTALLED IN ACCORDANCE WITH THE CITY EROSION CONTROL AND STORMWATER DRAINAGE AND THE DANE COUNTY EROSION CONTROL AND STORMWATER MANAGEMENT MANUAL. THE CITY RESERVES THE RIGHT TO REQUIRE ADDITIONAL EROSION CONTROL MEASURES AS CONDITIONS WARRANT.
- (3) CLEANING. RIGHT-OF-WAY SURFACES SHALL BE THOROUGHLY CLEANED BEFORE THE END OF EACH WORKING DAY.
- (4) RESTORATION. RESTORATION SHALL BE COMPLETED AS NOTED IN THE CONSTRUCTION SCHEDULE UNLESS OTHERWISE AUTHORIZED BY THE CITY.
- (5) INSPECTION. THE CONTRACTOR SHALL INSPECT EROSION AND SEDIMENT CONTROL PRACTICES WEEKLY, AND WITHIN 24 HOURS FOLLOWING A RAINFALL OF 0.5 INCHES OR GREATER. DOCUMENTATION OF EACH INSPECTION SHALL BE ENTERED INTO THE CITY EROSION CONTROL PERMIT TRACKING WEBSITE, AND SHALL INCLUDE THE TIME, DATE, AND LOCATION OF INSPECTION, THE PHASE OF LAND DISTURBANCE AT THE CONSTRUCTION SITE, PERSON CONDUCTING THE INSPECTION, ASSESSMENT OF CONTROL PRACTICES, AND A DESCRIPTION OF ANY EROSION OR SEDIMENT CONTROL MEASURE INSTALLATION.
- (6) STONE TRACKING PAD. BEFORE BEGINNING CONSTRUCTION, CONTRACTOR SHALL INSTALL A STONE TRACKING PAD AT EACH POINT WHERE VEHICLES ENTER/EXIT THE CONSTRUCTION SITE. STONE TRACKING PADS SHOULD BE AT LEAST 24 FEET WIDE AND 50 FEET LONG, AND CONSTRUCTED OF 3-8 INCH WASHED STONE WITH A DEPTH OF AT LEAST 12 INCHES. ON SITES WITH CLAY SOILS, STONE TRACKING PADS MUST BE UNDERLAIN WITH A GEOTEXTILE LINER TO PREVENT THE STONE FROM SINKING INTO THE SOIL.
- (7) INLET PROTECTION. ALL INLETS SUBJECT TO DRAINAGE SHALL BE PROTECTED WITH WISCONSIN DOT TYPE B INLET PROTECTION. ANY DEPOSITS OF DIRT, MUD, ROCK, DEBRIS, OR OTHER MATERIAL ENTERING THE STORM SEWER SYSTEM SHALL BE PROMPTLY AND THOROUGHLY CLEANED OUT.
- (8) EROSION MAT. AREAS OR EMBANKMENTS HAVING SLOPES GREATER THAN OR EQUAL TO 4H:1V SHALL BE STABILIZED WITH WISCONSIN DOT CLASS 1, URBAN, TYPE B, EROSION MAT.
- (9) TEMPORARY EROSION CONTROL. ALL TEMPORARY EROSION AND SEDIMENT CONTROL MEASURES SHALL BE REMOVED WITHIN 30 DAYS AFTER FINAL SITE STABILIZATION IS ACHIEVED OR AFTER THE TEMPORARY MEASURES ARE NO LONGER NEEDED.
- (10) STABILIZATION. ALL DISTURBED AREAS SHALL BE SEEDING & MULCHED AS SPECIFIED WITHIN 14 WORKING DAYS OF FINAL GRADING.
- (11) TOPSOIL. A MINIMUM OF 4 INCHES OF TOPSOIL MUST BE APPLIED TO ALL AREAS TO BE SEEDING OR SOODED.
- (12) SEEDING. REFER TO LANDSCAPING PLANS FOR MIXTURE AND APPLICATION REQUIREMENTS.
- (13) STOCKPILES. ANY SOIL STOCKPILES THAT REMAINS FOR MORE THAN 30 DAYS SHALL BE COVERED OR TREATED WITH STABILIZATION PRACTICES SUCH AS TEMPORARY OR PERMANENT SEEDING AND MULCHING.

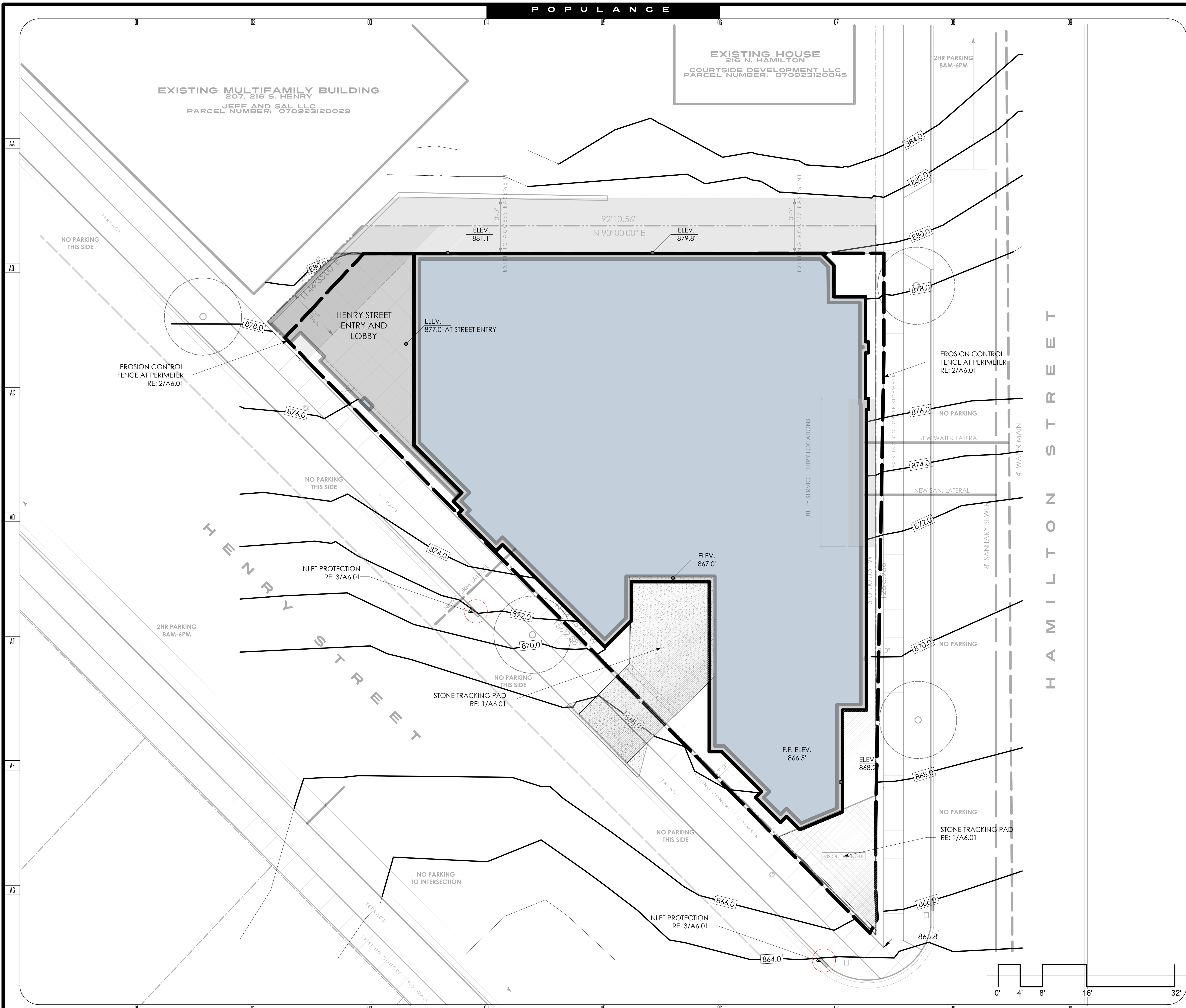

UDC INFORMATIONAL

HENRY HAMILTON PARTNERS 100 KING STREET MADISON, WI 53703		DATE 07.18.18
THE BARRACUDA 100 KING STREET MADISON, WI 53703		C2.01
SITE GRADING AND EROSION CONTROL SCALE 1/8" = 1'-0"		



GENERAL NOTES

- 1: CONFIRM UTILITY LOCATIONS WITH NEW UTILITY WORK PERFORMED SPRING 2018
- 2: A WATER SERVICE APPLICATION FORM AND FEES MUST BE SUBMITTED BEFORE CONNECTING TO THE EXISTING WATER SYSTEM. PROVIDE AT LEAST TWO WORKING DAYS NOTICE BETWEEN THE APPLICATION SUBMITAL AND THE REQUESTED INSTALLATION OR INSPECTION APPOINTMENT. APPLICATION MATERIALS MAY BE OBTAINED FROM THE WATER UTILITY MAIN OFFICE AT 119 E. OLIN AVENUE.
- 3: A LICENSED PLUMBER SIGNATURE IS REQUIRED ON ALL WATER SERVICE APPLICATIONS. FOR NEW OR REPLACEMENT SERVICES, THE PROPERTY OWNER OR AUTHORIZED AGENT IS ALSO REQUIRED TO SIGN THE APPLICATION. A WATER METER APPLICATION FORM WILL SUBSEQUENTLY BE REQUIRED TO SIZE & OBTAIN A WATER METER ESTABLISH A WATER UTILITY CUSTOMER ACCOUNT AND/OR ESTABLISH A WATER UTILITY FIRE SERVICE ACCOUNT.

DRAWING NOTES

CODE NOTES

DATE DESCRIPTION

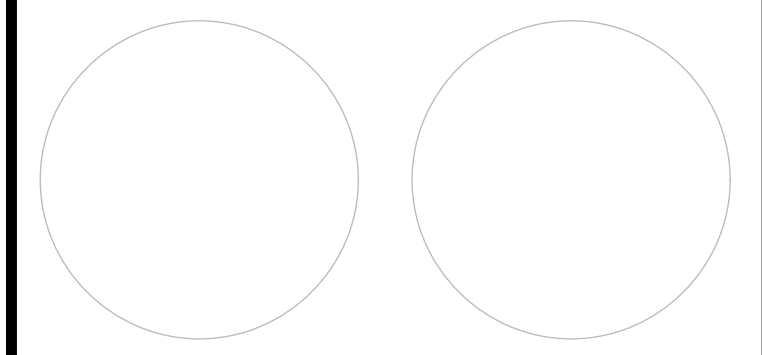

UDC INFORMATIONAL

HENRY HAMILTON PARTNERS
10 KING STREET
MADISON, WI 53703

DATE

07.18.18

THE BARRACUDA
MADISON, WI 53703

C3.01

UTILITY PLAN

SCALE 1/8" = 1'-0"

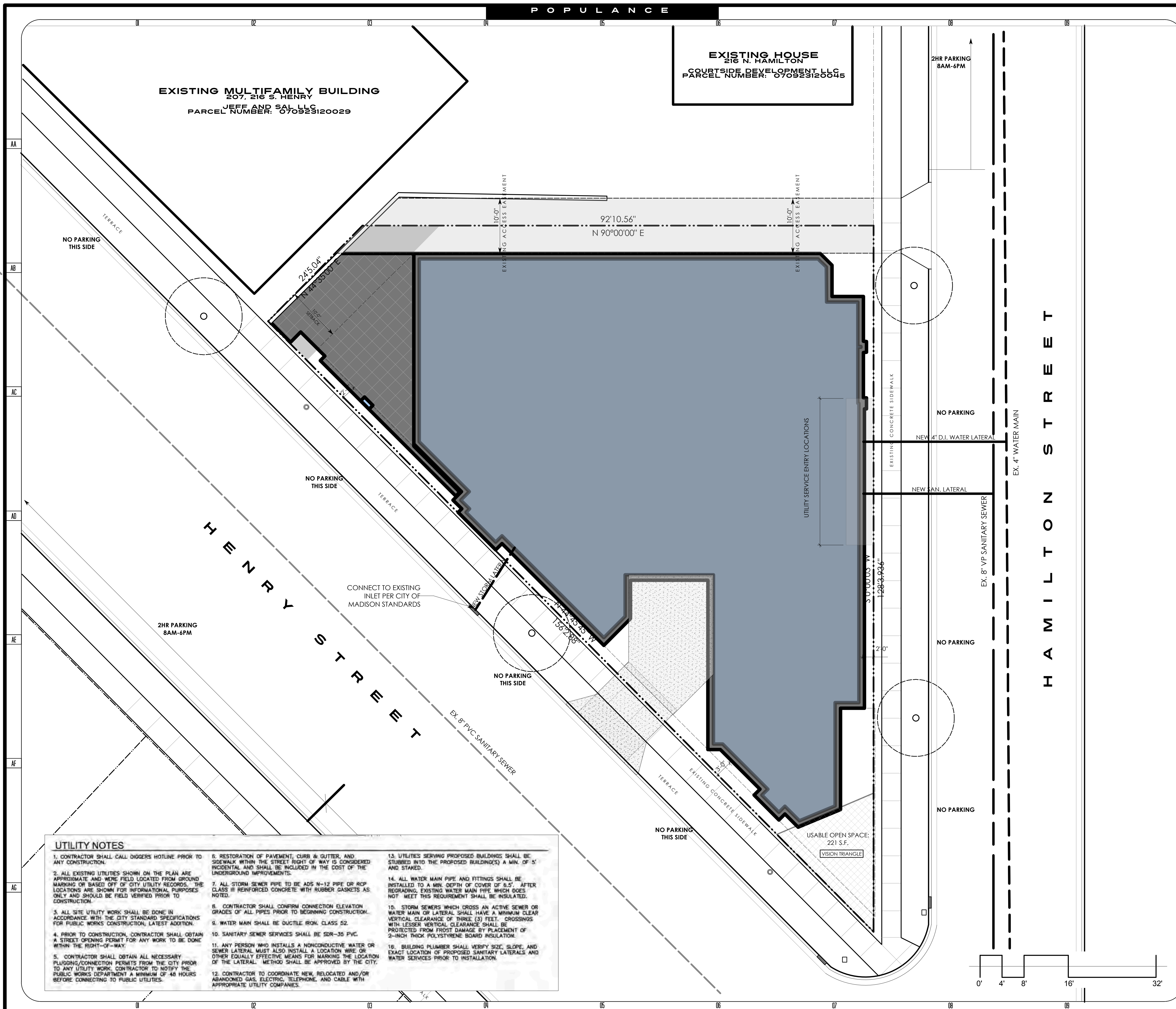

UTILITY NOTES

- CONTRACTOR SHALL CALL DIGGERS HOTLINE PRIOR TO ANY CONSTRUCTION.
- ALL EXISTING UTILITIES SHOWN ON THE PLAN ARE APPROXIMATE AND WERE FIELD LOCATED FROM GROUND MARKINGS OR BASED OFF OF CITY UTILITY RECORDS. THE LOCATIONS ARE SHOWN FOR INFORMATIONAL PURPOSES ONLY AND SHOULD BE FIELD VERIFIED PRIOR TO CONSTRUCTION.
- ALL SITE UTILITY WORK SHALL BE DONE IN ACCORDANCE WITH THE CITY STANDARD SPECIFICATIONS FOR PUBLIC WORKS CONSTRUCTION, LATEST ADDITION.
- PRIOR TO CONSTRUCTION, CONTRACTOR SHALL OBTAIN A STREET OPENING PERMIT FOR ANY WORK TO BE DONE WITHIN THE RIGHT-OF-WAY.
- CONTRACTOR SHALL OBTAIN ALL NECESSARY PLUGGING/CONNECTION PERMITS FROM THE CITY PRIOR TO ANY UTILITY WORK. CONTRACTOR TO NOTIFY THE PUBLIC WORKS DEPARTMENT A MINIMUM OF 48 HOURS BEFORE CONNECTING TO PUBLIC UTILITIES.
- RESTORATION OF PAVEMENT, CURB & GUTTER, AND SIDEWALK WITHIN THE STREET RIGHT OF WAY IS CONSIDERED INCIDENTAL AND SHALL BE INCLUDED IN THE COST OF THE UNDERGROUND IMPROVEMENTS.
- ALL STORM SEWER PIPE TO BE ADS N-12 PIPE OR RCP CLASS III REINFORCED CONCRETE WITH RUBBER GASKETS AS NOTED.
- CONTRACTOR SHALL CONFIRM CONNECTION ELEVATION GRADES OF ALL PIPES PRIOR TO BEGINNING CONSTRUCTION.
- WATER MAIN SHALL BE DUCTILE IRON, CLASS 52.
- SANITARY SEWER SERVICES SHALL BE SDR-35 PVC.
- ANY PERSON WHO INSTALLS A NONCONDUCTIVE WATER OR SEWER LATERAL MUST ALSO INSTALL A LOCATION WIRE OR OTHER EQUALLY EFFECTIVE MEANS FOR MARKING THE LOCATION OF THE LATERAL. METHOD SHALL BE APPROVED BY THE CITY.
- CONTRACTOR TO COORDINATE NEW, RELOCATED AND/OR ABANDONED GAS, ELECTRIC, TELEPHONE, AND CABLE WITH APPROPRIATE UTILITY COMPANIES.
- UTILITIES SERVING PROPOSED BUILDINGS SHALL BE STUBBED INTO THE PROPOSED BUILDING(S) A MIN. OF 5' AND STAKED.
- ALL WATER MAIN PIPE AND FITTINGS SHALL BE INSTALLED TO A MIN. DEPTH OF COVER OF 6.5'. AFTER REGRADING, EXISTING WATER MAIN PIPE WHICH DOES NOT MEET THIS REQUIREMENT SHALL BE INSULATED.
- STORM SEWERS WHICH CROSS AN ACTIVE SEWER OR WATER MAIN OR LATERAL SHALL HAVE A MINIMUM CLEAR VERTICAL CLEARANCE OF THREE (3) FEET. CROSSINGS WITH LESSER VERTICAL CLEARANCE SHALL BE PROTECTED FROM FROST DAMAGE BY PLACEMENT OF 2-INCH THICK POLYSTYRENE BOARD INSULATION.
- BUILDING PLUMBER SHALL VERIFY SIZE, SLOPE, AND EXACT LOCATION OF PROPOSED SANITARY LATERALS AND WATER SERVICES PRIOR TO INSTALLATION.

DATE DESCRIPTION

DATE	DESCRIPTION

ARCHITECT STRUCTURAL ENGINEER

UDC INFORMATIONAL

HENRY HAMILTON PARTNERS
221 S. HAMILTON STREET
MADISON, WI 53703

DATE
07.18.18

THE BARRACUDA
MADISON, WI 53703

C4.01

FIRE APPARATUS ANALYSIS

SCALE 1/8" = 1'-0"

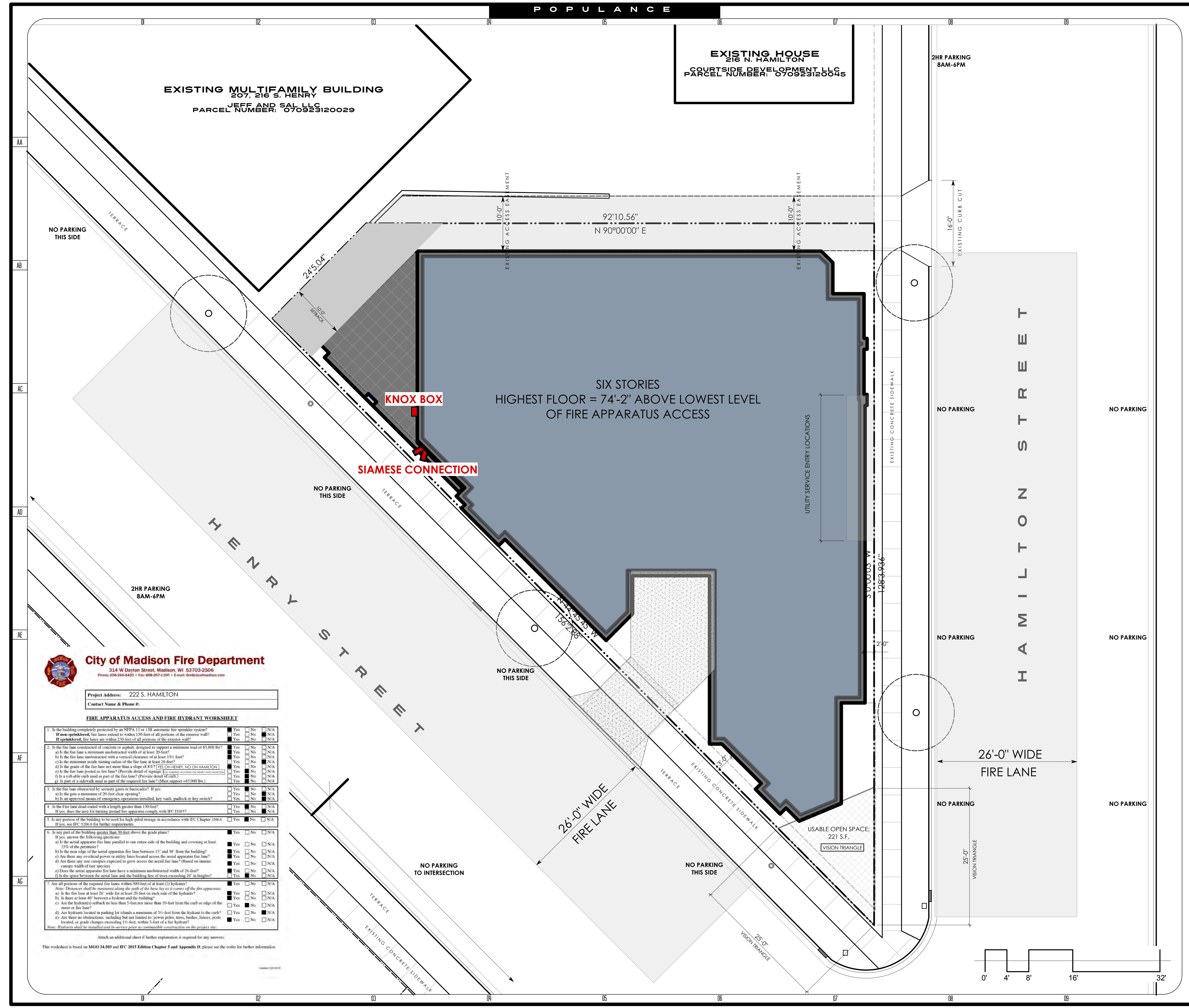

EXISTING MULTIFAMILY BUILDING
207, 216 S. HENRY
JEFF AND SAL LLC
PARCEL NUMBER: 070923120029

EXISTING HOUSE
216 N. HAMILTON
COURTSIDE DEVELOPMENT LLC
PARCEL NUMBER: 070923120045

SIX STORIES
HIGHEST FLOOR = 74'-2" ABOVE LOWEST LEVEL
OF FIRE APPARATUS ACCESS

City of Madison Fire Department
314 W Dayton Street, Madison, WI 53703-2506
Phone: 608-260-4420 • Fax: 608-267-1100 • E-mail: fire@cityofmadison.com

Project Address: 222 S. HAMILTON
Contact Name & Phone #:

FIRE APPARATUS ACCESS AND FIRE HYDRANT WORKSHEET

1. Is the building completely protected by an NFPA 13 or 13R automatic fire sprinkler system?	Yes	No	N/A
If non-sprinklered, fire lanes extend to within 150-feet of all portions of the exterior wall?	Yes	No	N/A
If sprinklered, fire lanes are within 250-feet of all portions of the exterior wall?	Yes	No	N/A
2. Is the fire lane constructed of concrete or asphalt, designed to support a minimum load of 85,000 lbs?	Yes	No	N/A
a) Is the fire lane a minimum unobstructed width of at least 20-feet?	Yes	No	N/A
b) Is the fire lane unobstructed with a vertical clearance of at least 13'-0" feet?	Yes	No	N/A
c) Is the minimum inside turning radius of the fire lane at least 28-feet?	Yes	No	N/A
d) Is the grade of the fire lane not more than a slope of 8%? (YES ON HENRY, NO ON HAMILTON)	Yes	No	N/A
e) Is the fire lane posted as fire lanes? (Provide detail of signage. See notes regarding on-street fire vehicles.)	Yes	No	N/A
f) Is a rollable curb used as part of the fire lane? (Provide detail of curb.)	Yes	No	N/A
g) Is a rollable curb used as part of the required fire lane? (Must support +85,000 lbs.)	Yes	No	N/A
3. Is the fire lane obstructed by security gates or barricades? If yes:	Yes	No	N/A
a) Is the gate a minimum of 20-feet clear opening?	Yes	No	N/A
b) Is an approved means of emergency operations installed: key vault, padlock or key switch?	Yes	No	N/A
4. Is the fire lane dead-ended with a length greater than 150-feet?	Yes	No	N/A
If yes, does the area for turn-around fire apparatus comply with IFCD 1013?	Yes	No	N/A
5. Is any portion of the building to be used for high-piled storage in accordance with IFC Chapter 1206.6? If yes, see IFC 3206.6 for further requirements.	Yes	No	N/A
6. Is any part of the building greater than 30-feet above the grade plane?	Yes	No	N/A
If yes, answer the following questions:			
a) Is the aerial apparatus fire lane parallel to one entire side of the building and covering at least 25% of the perimeter?	Yes	No	N/A
b) Is the rear edge of the aerial apparatus fire lane between 15' and 50' from the building?	Yes	No	N/A
c) Are there any overhead power or utility lines located across the aerial apparatus fire lane?	Yes	No	N/A
d) Are there any canopies exposed to view across the aerial fire lane? (Based on maximum canopy width of face pieces.)	Yes	No	N/A
e) Does the aerial apparatus fire lane have a minimum unobstructed width of 26-feet?	Yes	No	N/A
f) Is the space between the aerial lane and the building free of trees exceeding 20' in height?	Yes	No	N/A
7. Are all portions of the required fire lanes within 500-feet of at least (2) hydrants?	Yes	No	N/A
Note: Distances shall be measured along the path of the hose line as it comes off the fire apparatus:			
a) Is the fire lane at least 26' wide for at least 20-feet on each side of the hydrant?	Yes	No	N/A
b) Is there at least 40' between a hydrant and the building?	Yes	No	N/A
c) Are the hydrants within 10-feet of the curb or edge of the street or fire lane?	Yes	No	N/A
d) Are hydrants located in parking lot islands a minimum of 30-feet from the hydrant to the curb?	Yes	No	N/A
e) Are there no obstructions, including but not limited to: power poles, trees, bushes, fences, posts, located or grade changes exceeding 10'-feet, within 5-feet of a fire hydrant?	Yes	No	N/A

Note: Hydrants shall be installed and in service prior to construction on the project site.

Attach an additional sheet if further explanation is required for any answers.

This worksheet is based on MGO 84.803 and IFC 2015 Edition Chapter 5 and Appendix D; please see the codes for further information.

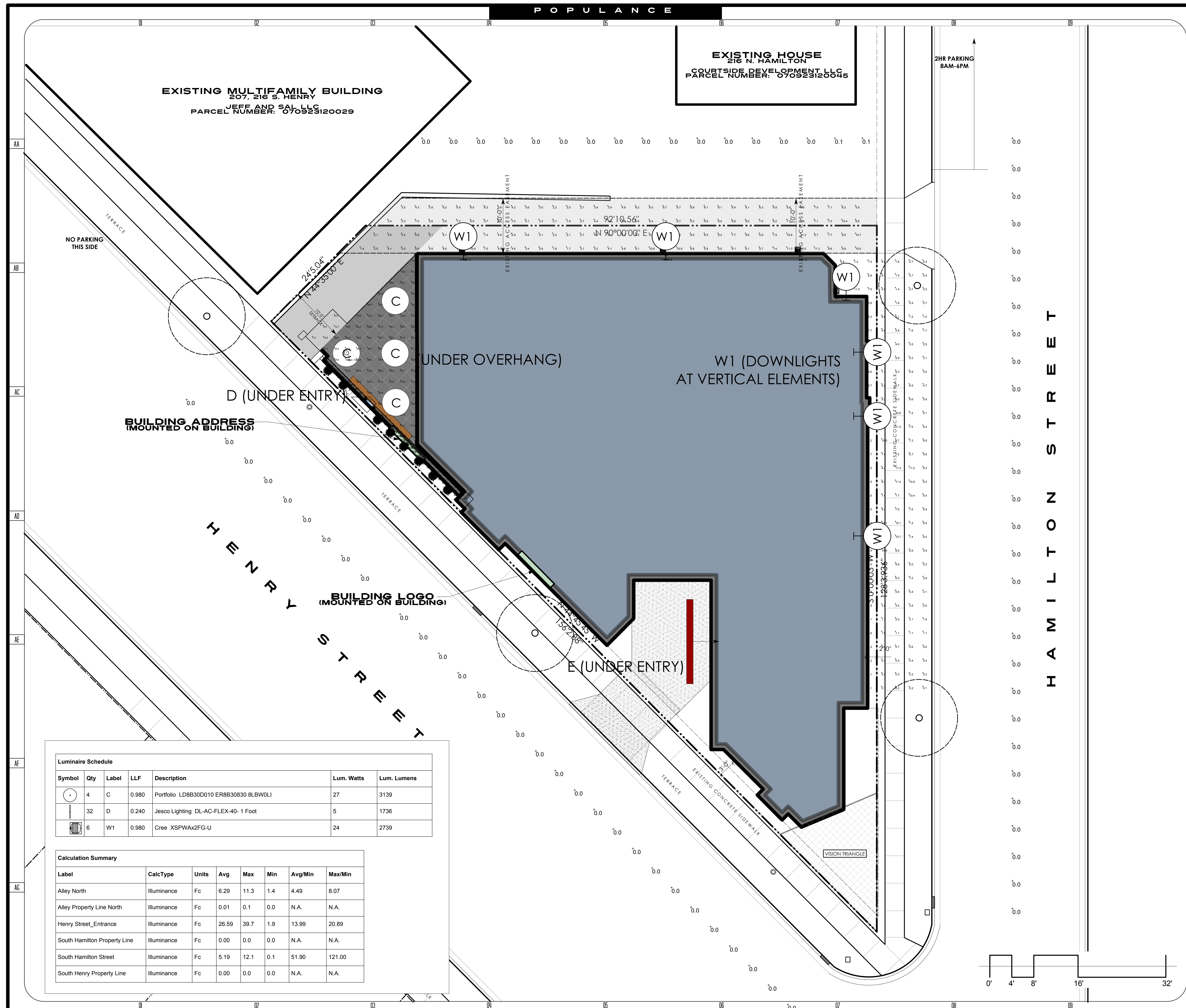

EXISTING HOUSE
216 N. HAMILTON
COURTSIDE DEVELOPMENT, LLC
PARCEL NUMBER: 070923120045

EXISTING MULTIFAMILY BUILDING
207, 216 S. HENRY
JEFF AND SAL LLC
PARCEL NUMBER: 070923120029

2HR PARKING
8AM-6PM

NO PARKING
THIS SIDE

W1

W1

W1

C

C

C

D (UNDER ENTRY)

BUILDING ADDRESS
(MOUNTED ON BUILDING)

UNDER OVERHANG)

W1 (DOWNLIGHTS
AT VERTICAL ELEMENTS)

W1

W1

W1

W1

W1

W1

BUILDING LOGO
(MOUNTED ON BUILDING)

E (UNDER ENTRY)

HENRY STREET

HAMILTON STREET

Symbol	Qty	Label	LLF	Description	Lum. Watts	Lum. Lumens
○	4	C	0.980	Portfolio LD8B30D010 ER8B30830 8LBW0LI	27	3139
—	32	D	0.240	Jesco Lighting DL-AC-FLEX-40- 1 Foot	5	1736
□	6	W1	0.980	Cree XSPWAx2FG-U	24	2739

Label	CalcType	Units	Avg	Max	Min	Avg/Min	Max/Min
Alley North	Illuminance	Fc	6.29	11.3	1.4	4.49	8.07
Alley Property Line North	Illuminance	Fc	0.01	0.1	0.0	N.A.	N.A.
Henry Street_Entrance	Illuminance	Fc	26.59	39.7	1.9	13.99	20.89
South Hamilton Property Line	Illuminance	Fc	0.00	0.0	0.0	N.A.	N.A.
South Hamilton Street	Illuminance	Fc	5.19	12.1	0.1	51.90	121.00
South Henry Property Line	Illuminance	Fc	0.00	0.0	0.0	N.A.	N.A.

BARRACUDA

GENERAL NOTES



HENRY STREET ENTRY LIGHTING CONCEPT

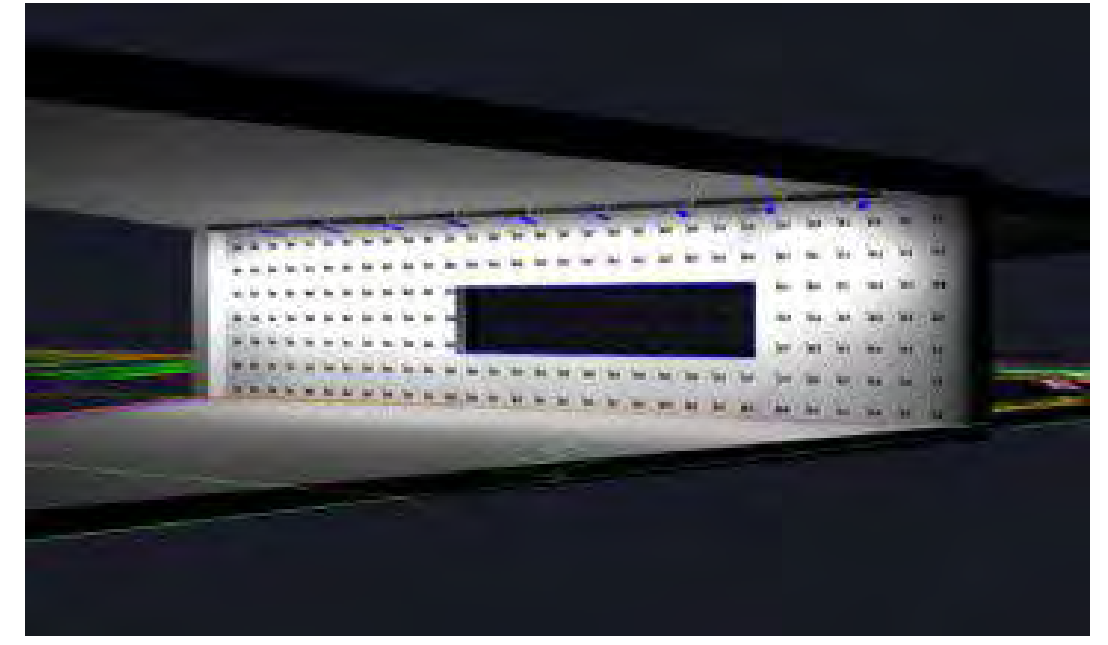

HENRY STREET PARKING ENTRY LIGHTING CONCEPT

UDC INFORMATIONAL

HENRY HAMILTON PARTNERS
101 KING STREET
MADISON, WI 53703

DATE
07.18.18

THE BARRACUDA
222 S. HAMILTON
MADISON, WI 53703

C5.01

SITE LIGHTING PLAN
SCALE 1/8" = 1'-0"

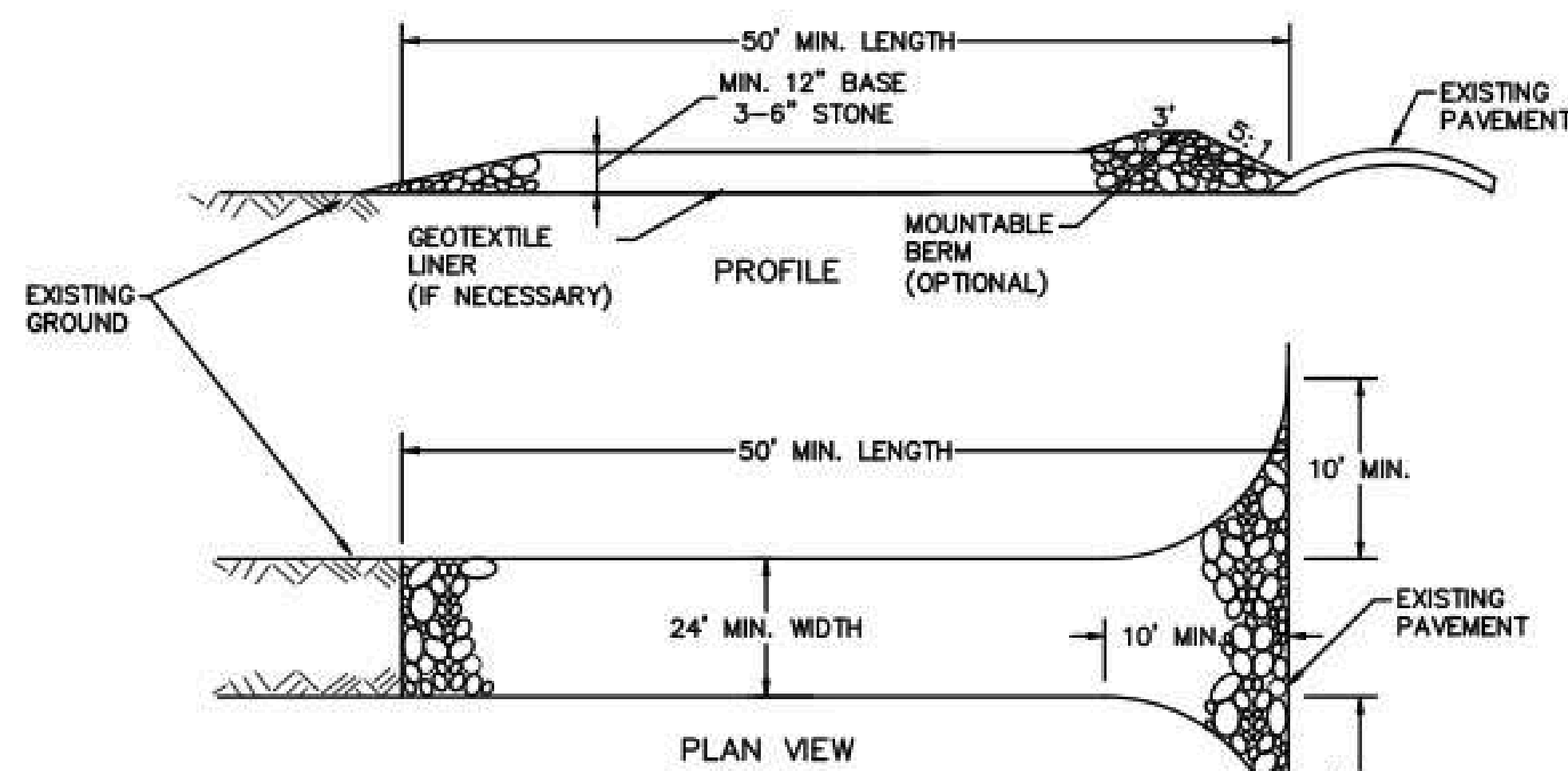

1 STONE TRACKING PAD
A6.01 NTS

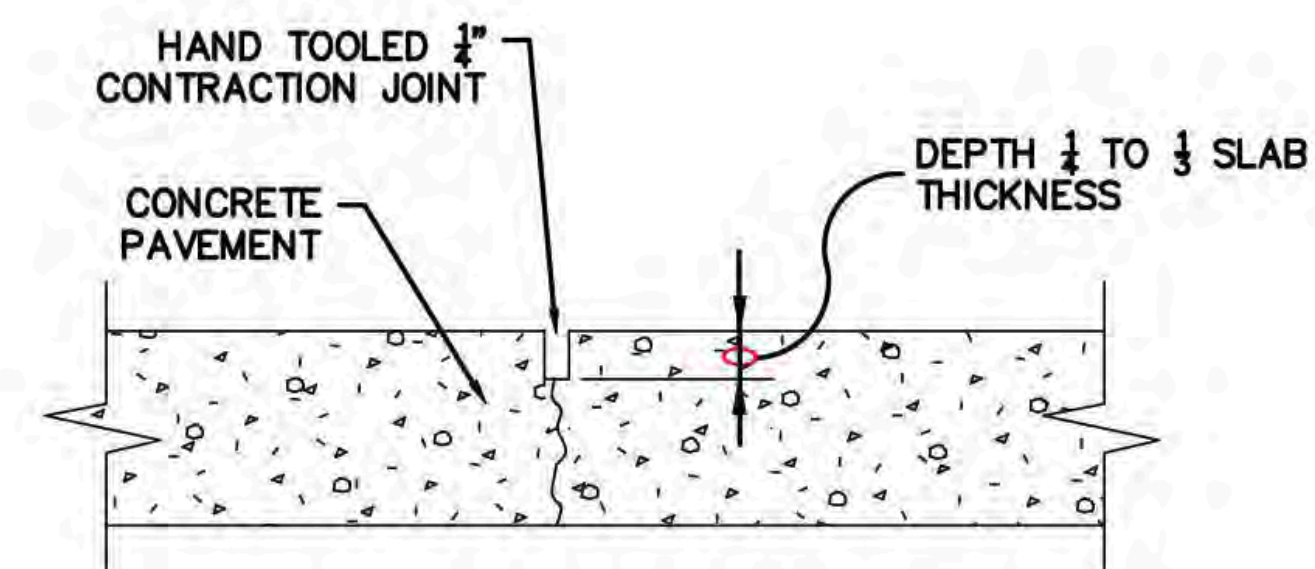

- NOTES:
1. JOINTS TO BE INSTALLED IN ACCORDANCE WITH CITY STANDARDS.
 2. ALL JOINTS TO BE TOOLED WITH 1/2\"/>

5 CONTROL JOINT
A6.01 NTS

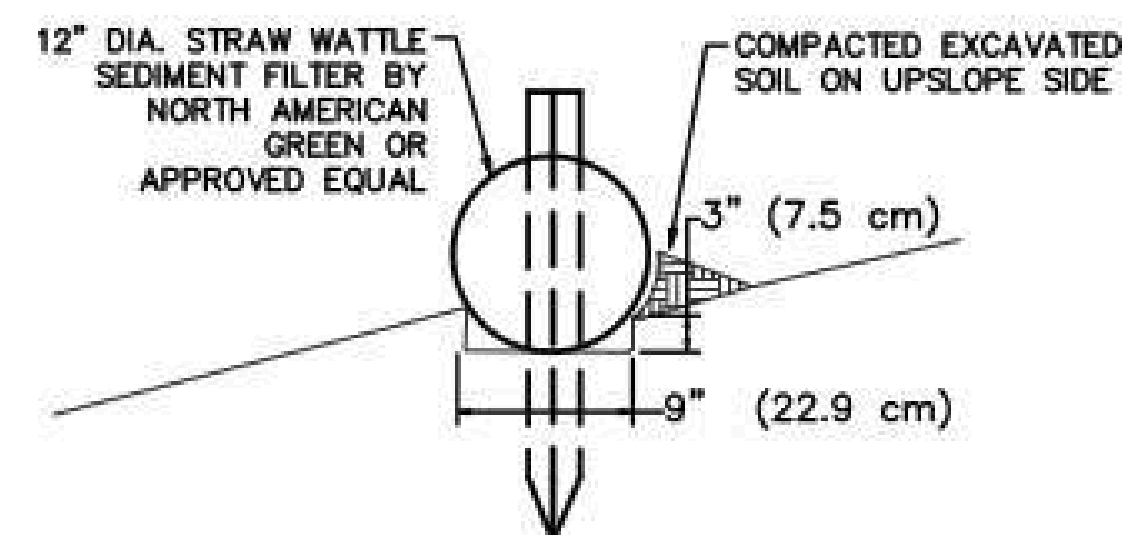

2 SEDIMENT FILTER
A6.01 NTS

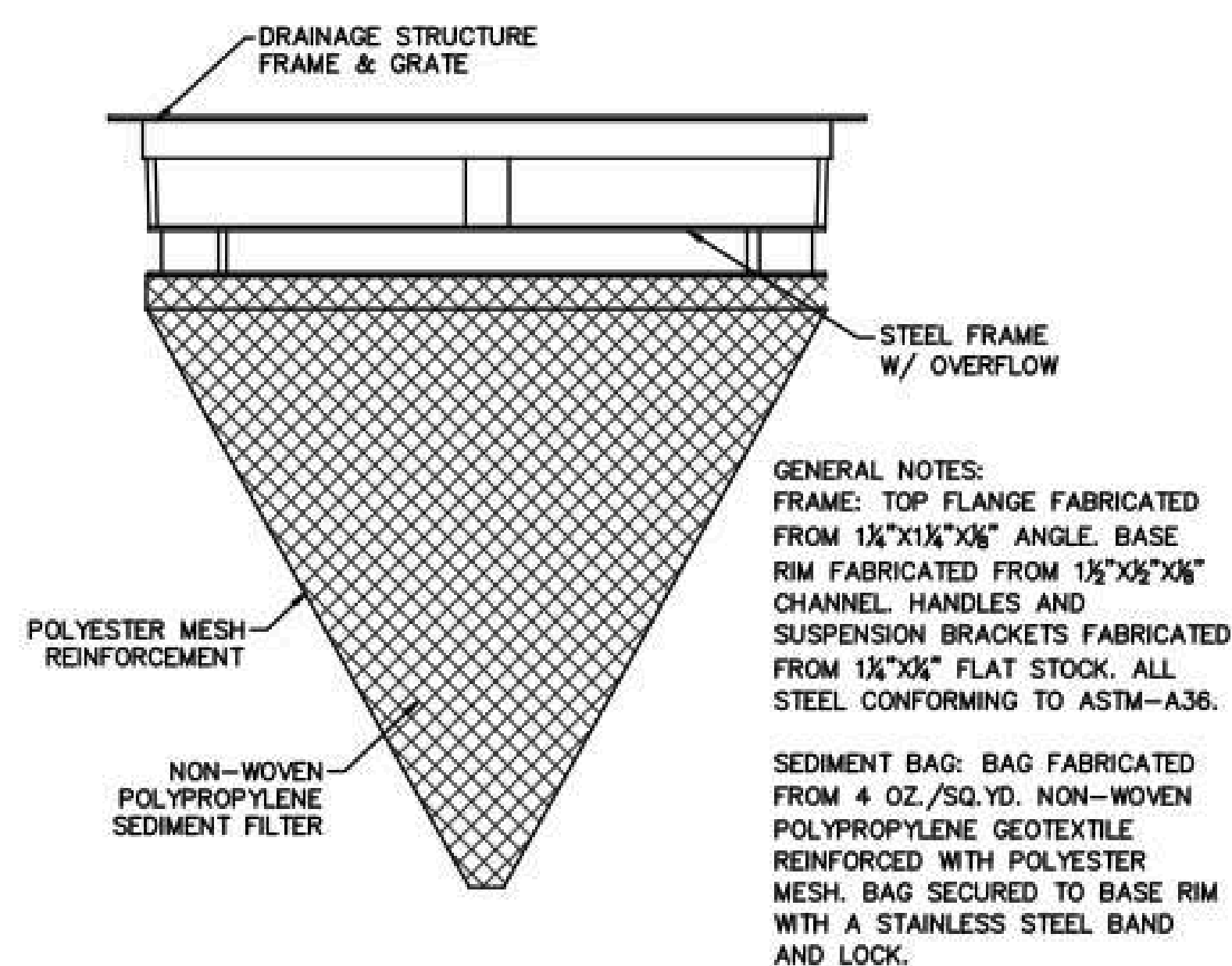

3 CATCH BASIN FILTER INSERT
A6.01 NTS

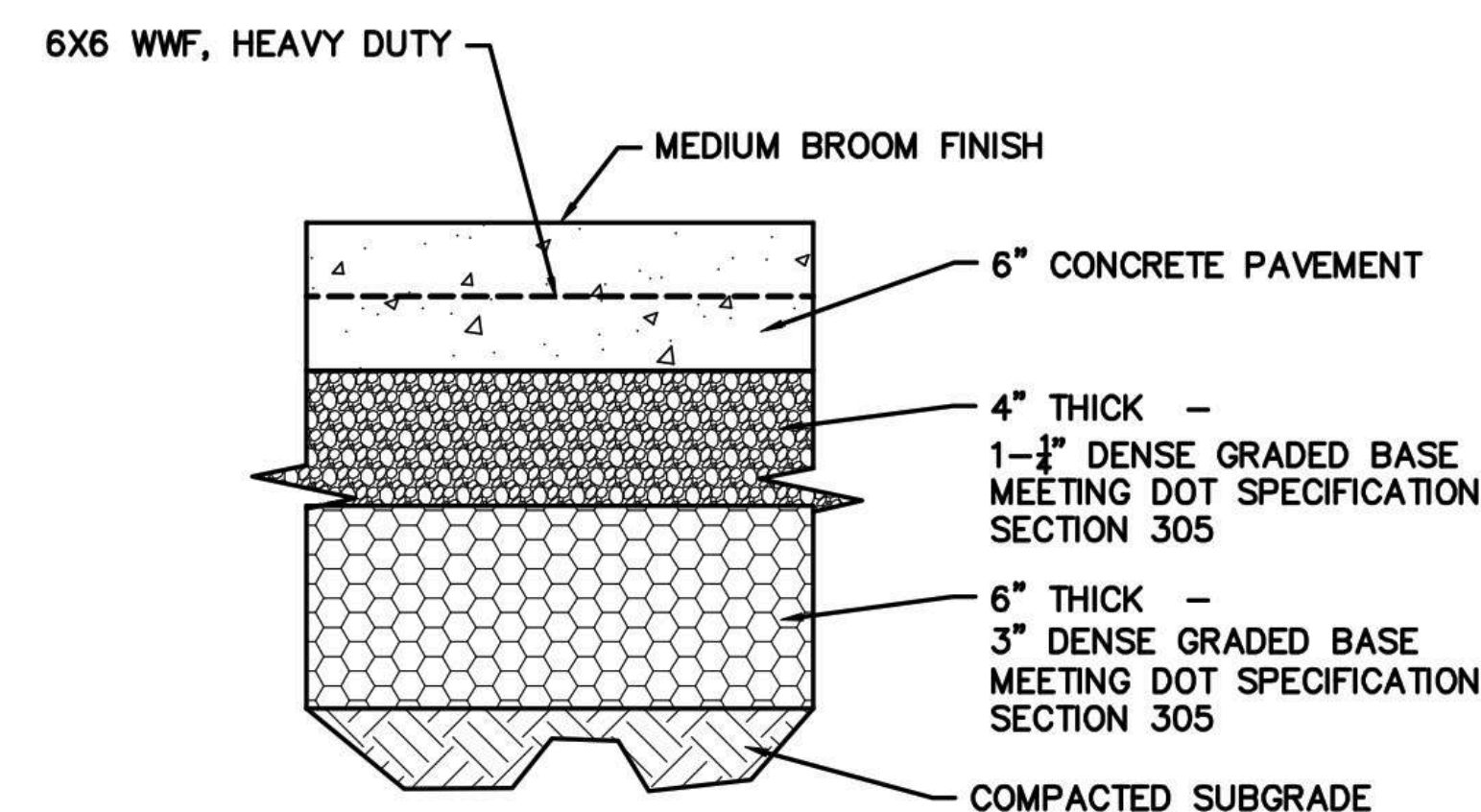

7 DRIVEWAY CONCRETE
A6.01 NTS

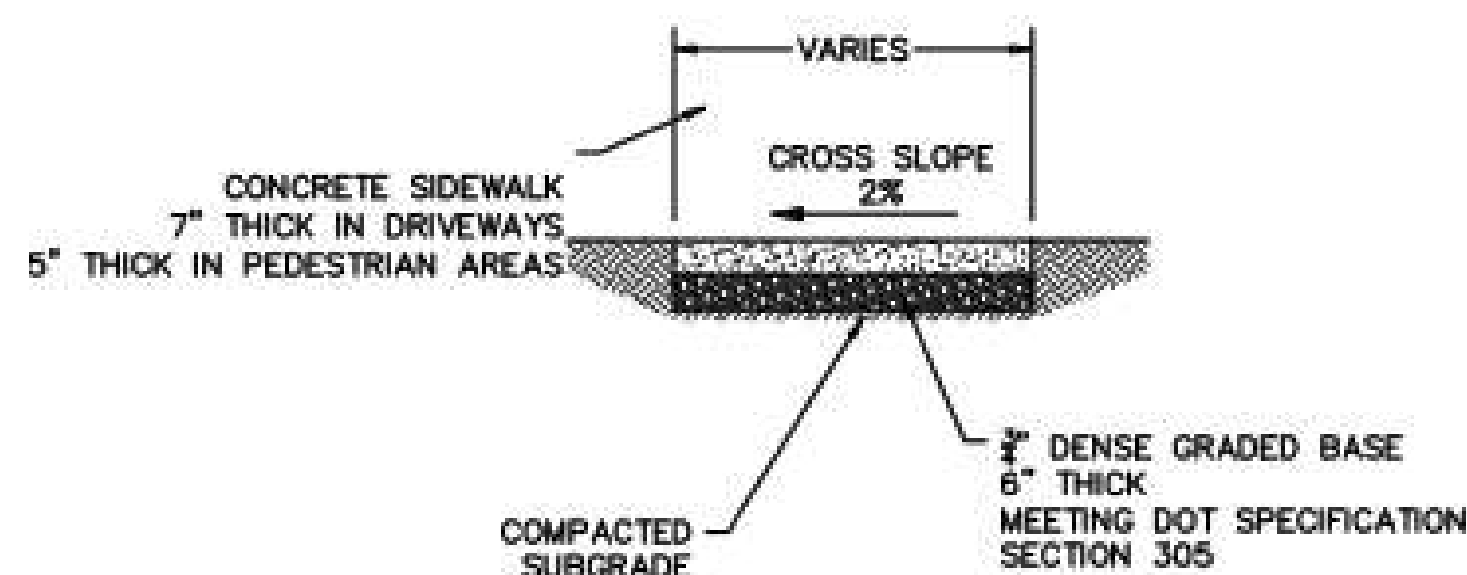

4 SIDEWALK SECTION
A6.01 NTS

DATE	DESCRIPTION

UDC INFORMATIONAL

HENRY HAMILTON PARTNERS
225 KING STREET
MADISON, WI 53703

THE BARRACUDA
225 KING STREET
MADISON, WI 53703

DATE
07.18.18

C6.01

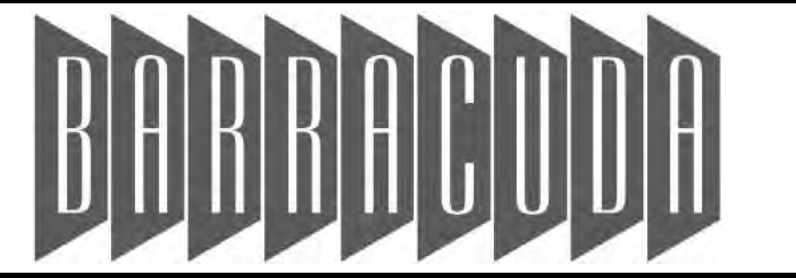
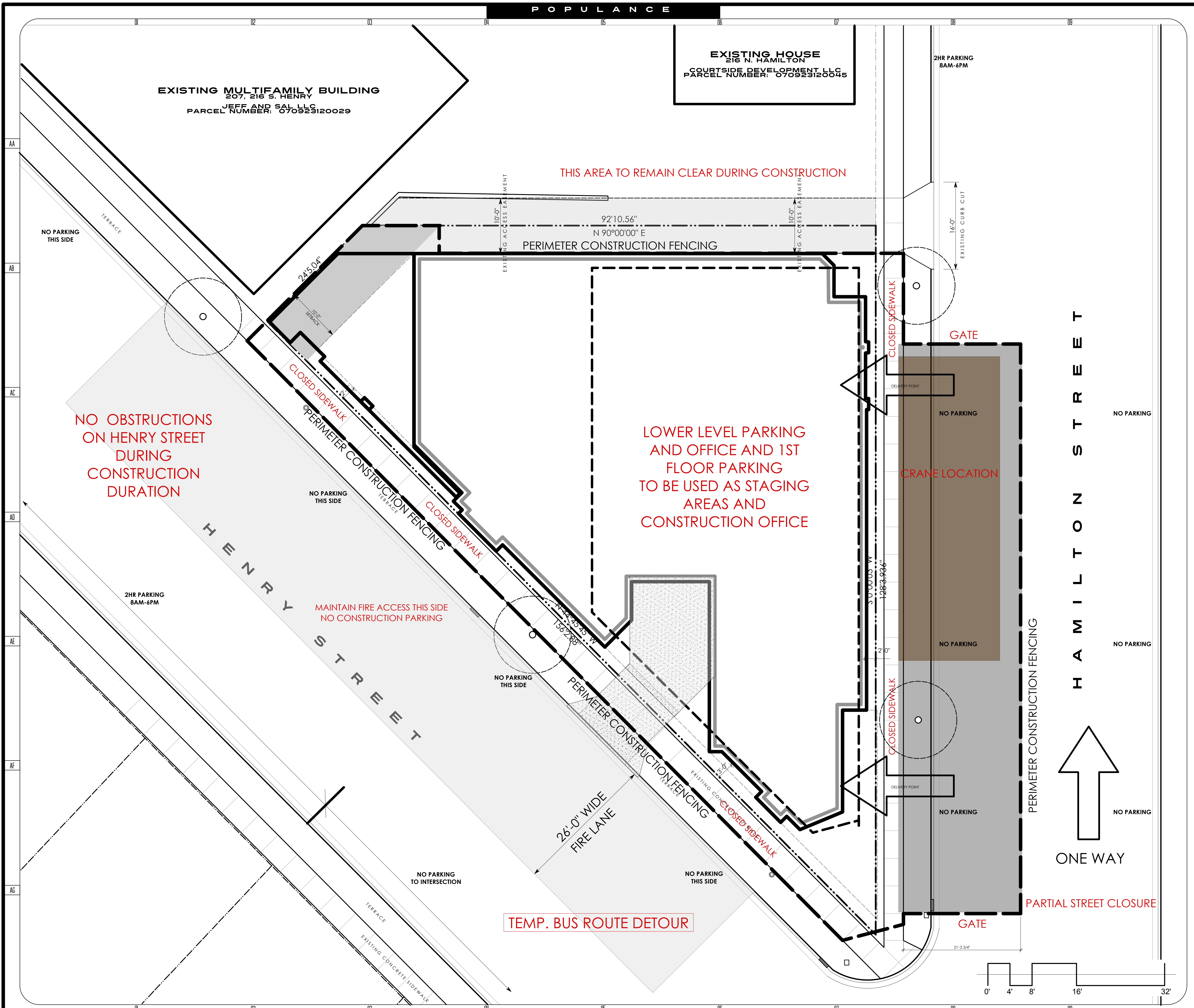

GENERAL NOTES

- 1: ALLEY ACCESS MIDBLOCK ON HAMILTON MUST NOT BE OBSTRUCTED DURING CONSTRUCTION
- 2: NO CONSTRUCTION PARKING ON HAMILTON OR HENRY STREETS
- 3: HAMILTON BUSES TO TEMPORARILY DETOUR TO HENRY STREET DURING BUILDING ERECTION WHEN CRANE IS ON SITE
- 4: PERIMETER OF SITE TO RECEIVE CONSTRUCTION FENCING

DRAWING NOTES

CODE NOTES

DATE	DESCRIPTION

UDC INFORMATIONAL

HENRY HAMILTON PARTNERS 222 S. HAMILTON STREET MADISON, WI 53703	
DATE	07.18.18

THE BARRACUDA 222 S. HAMILTON STREET MADISON, WI 53703	C7.01
STAGING AND CONSTRUCTION ACCESS SCALE 1/8" = 1'-0"	

- 1: ALL EXISTING STREET TREES TO BE PROTECTED
 - 2: CONTRACTOR SHALL INSTALL TREE PROTECTION FENCING IN THE AREA BETWEEN THE CURB AND SIDEWALK AND EXTEND IT AT LEAST 5 FEET FROM BOTH SIDES OF THE TREE ALONG THE LENGTH OF THE TERRACE.
- NO EXCAVATION IS PERMITTED WITHIN 5 FEET OF THE OUTSIDE EDGE OF A TREE TRUNK. IF EXCAVATION WITHIN 5 FEET OF ANY TREE IS NECESSARY, CONTRACTOR SHALL CONTACT CITY FORESTRY (266-4816) PRIOR TO EXCAVATION TO ASSESS THE IMPACT TO THE TREE AND ROOT SYSTEM.
- TREE PRUNING SHALL BE COORDINATED WITH CITY FORESTRY PRIOR TO THE START OF CONSTRUCTION. TREE PROTECTION SPECIFICATIONS CAN BE FOUND IN SECTION 107.13 OF CITY OF MADISON STANDARD SPECIFICATIONS FOR PUBLIC WORKS CONSTRUCTION [HTTP://WWW.CITYOFMADISON.COM/BUSINESS/PW/DOCUMENTS/STDSPECS/2018/PART1.PDF](http://www.cityofmadison.com/business/pw/documents/stdspecs/2018/PART1.PDF)
- ANY TREE REMOVALS THAT ARE REQUIRED FOR CONSTRUCTION AFTER THE DEVELOPMENT PLAN IS APPROVED WILL REQUIRE AT LEAST A 72 HOUR WAIT PERIOD BEFORE A TREE REMOVAL PERMIT CAN BE ISSUED BY FORESTRY. TO NOTIFY THE ALDER OF THE CHANGE IN THE TREE PLAN.
- 3: ADDITIONAL STREET TREES ARE NEEDED FOR THIS PROJECT. ALL STREET TREE PLANTING LOCATIONS AND TREE SPECIES WITHIN THE RIGHT OF WAY SHALL BE DETERMINED BY CITY FORESTRY. PLEASE SUBMIT A SITE PLAN (IN PDF FORMAT) TO BRAD HOFMANN - [BFHOFMANN@CITYOFMADISON.COM](mailto:bfhofmann@cityofmadison.com) OR 266-4816. TREE PLANTING SPECIFICATIONS CAN BE FOUND IN SECTION 209 OF CITY OF MADISON STANDARD SPECIFICATIONS FOR PUBLIC WORKS CONSTRUCTION
 - 4: GENERAL CONTRACTOR, ARCHITECT, AND CITY FORESTRY SHALL COORDINATE ALL STAGING AND SEQUENCING OPERATIONS NECESSARY FOR CONSTRUCTION OF BUILDING PRIOR TO CONSTRUCTION START. ALL PROPOSED PRUNING OF EXISTING STREET TREES (INCLUDING BOTH SIDES OF HENRY STREET) TO BE PERFORMED BY CITY FORESTRY.

PLANT LEGEND

- (A) JAPANESE MAPLE
- (B) VITIS RIPARIA- RIVERBANK GRAPE
- (C) CALAMAGROSTIS X ACUTIFLORA - FEATHER REED GRASS
- (D) PHYLLOSTACHYS AUREOSULCATA - GROOVE BAMBOO
- (E) GALIUM ODORATUM - SWEET WOODRUFF
- (F) LYSIMACHIA NUMMULARIA - CREEPING JENNY

SITE AREA: 7,867 S.F.
 LANDSCAPING POINTS:
 5 POINTS/300 S.F. OF DEVELOPED AREA
 $7,867/300 = 27 \times 5 = 135$ POINTS REQUIRED
 136 POINTS PROPOSED

UDC INFORMATIONAL

HENRY HAMILTON PARTNERS
 221 N. HAMILTON STREET
 MADISON, WI 53703

DATE
 07.18.18

THE BARRACUDA
 221 N. HAMILTON STREET
 MADISON, WI 53703

L1.01

LANDSCAPING PLAN
 SCALE 1/8" = 1'-0"

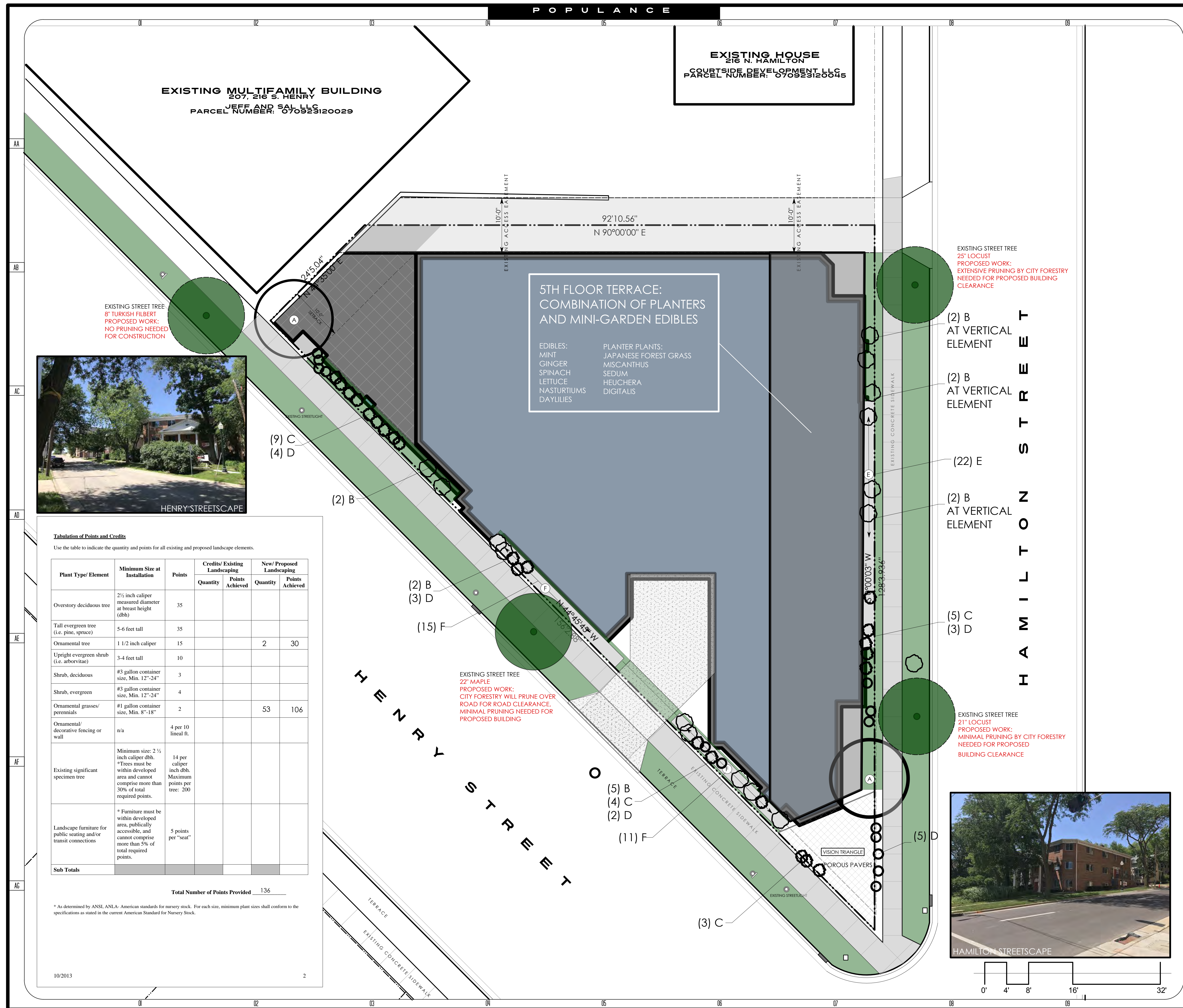

EXISTING MULTIFAMILY BUILDING
 207, 216 S. HENRY
 JEFF AND SAL LLC
 PARCEL NUMBER: 070923120029

EXISTING HOUSE
 216 N. HAMILTON
 COURTSIDE DEVELOPMENT LLC
 PARCEL NUMBER: 070923120045

5TH FLOOR TERRACE:
 COMBINATION OF PLANTERS
 AND MINI-GARDEN EDIBLES

EDIBLES:
 MINT
 GINGER
 SPINACH
 LETTUCE
 NASTURTIUMS
 DAYLILIES

PLANTER PLANTS:
 JAPANESE FOREST GRASS
 MISCANTHUS
 SEDUM
 HEUCHERA
 DIGITALIS



Tabulation of Points and Credits
 Use the table to indicate the quantity and points for all existing and proposed landscape elements.

Plant Type/ Element	Minimum Size at Installation	Points	Credits/ Existing Landscaping		New/ Proposed Landscaping	
			Quantity	Points Achieved	Quantity	Points Achieved
Overstory deciduous tree	2 1/2 inch caliper measured diameter at breast height (dbh)	35				
Tall evergreen tree (i.e. pine, spruce)	5-6 feet tall	35				
Ornamental tree	1 1/2 inch caliper	15			2	30
Upright evergreen shrub (i.e. arborvitae)	3-4 feet tall	10				
Shrub, deciduous	#3 gallon container size, Min. 12"-24"	3				
Shrub, evergreen	#3 gallon container size, Min. 12"-24"	4				
Ornamental grasses/perennials	#1 gallon container size, Min. 8"-18"	2			53	106
Ornamental/ decorative fencing or wall	n/a	4 per 10 lineal ft.				
Existing significant specimen tree	Minimum size: 2 1/2 inch caliper dbh. *Trees must be within developed area and cannot comprise more than 30% of total required points.	14 per caliper inch dbh. Maximum points per tree: 200				
Landscape furniture for public seating and/or transit connections	* Furniture must be within developed area, publicly accessible, and cannot comprise more than 5% of total required points.	5 points per "seat"				
Sub Totals						

Total Number of Points Provided 136

* As determined by ANSI, ANLA - American standards for nursery stock. For each size, minimum plant sizes shall conform to the specifications as stated in the current American Standard for Nursery Stock.

DATE	DESCRIPTION

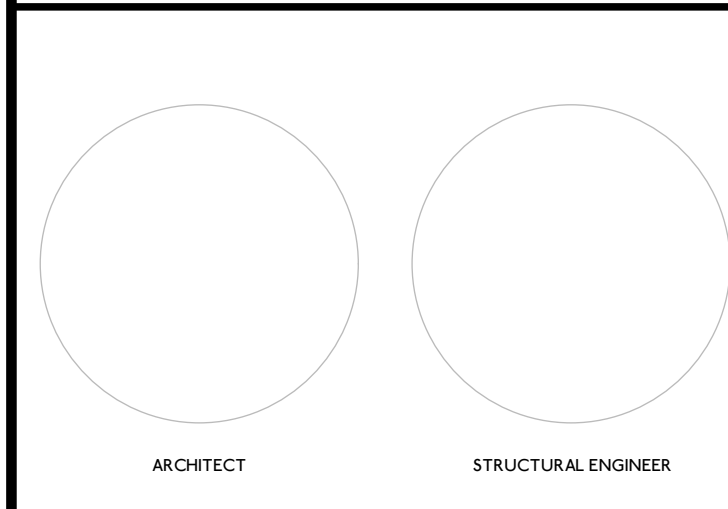

UDC INFORMATIONAL

HENRY HAMILTON PARTNERS 22 S. HAMILTON STREET MADISON, WI 53703		DATE
THE BARRACUDA 22 S. HAMILTON STREET MADISON, WI 53703		07.18.18
LANDSCAPING DETAILS		L1.02

STREETSCAPE SPECIES



(A) JAPANESE MAPLE



(B) VITIS RIPARIA- RIVERBANK GRAPE



(C) CALAMAGROSTIS X ACUTIFLORA - FEATHER REED GRASS



(D) PHYLLOSTACHYS AUREOSULCATA YELLOW GROOVE BAMBOO



(E) GALIUM ODORATUM SWEET WOODRUFF



(F) LYSIMACHIA NUMMULARIA CREEPING JENNY

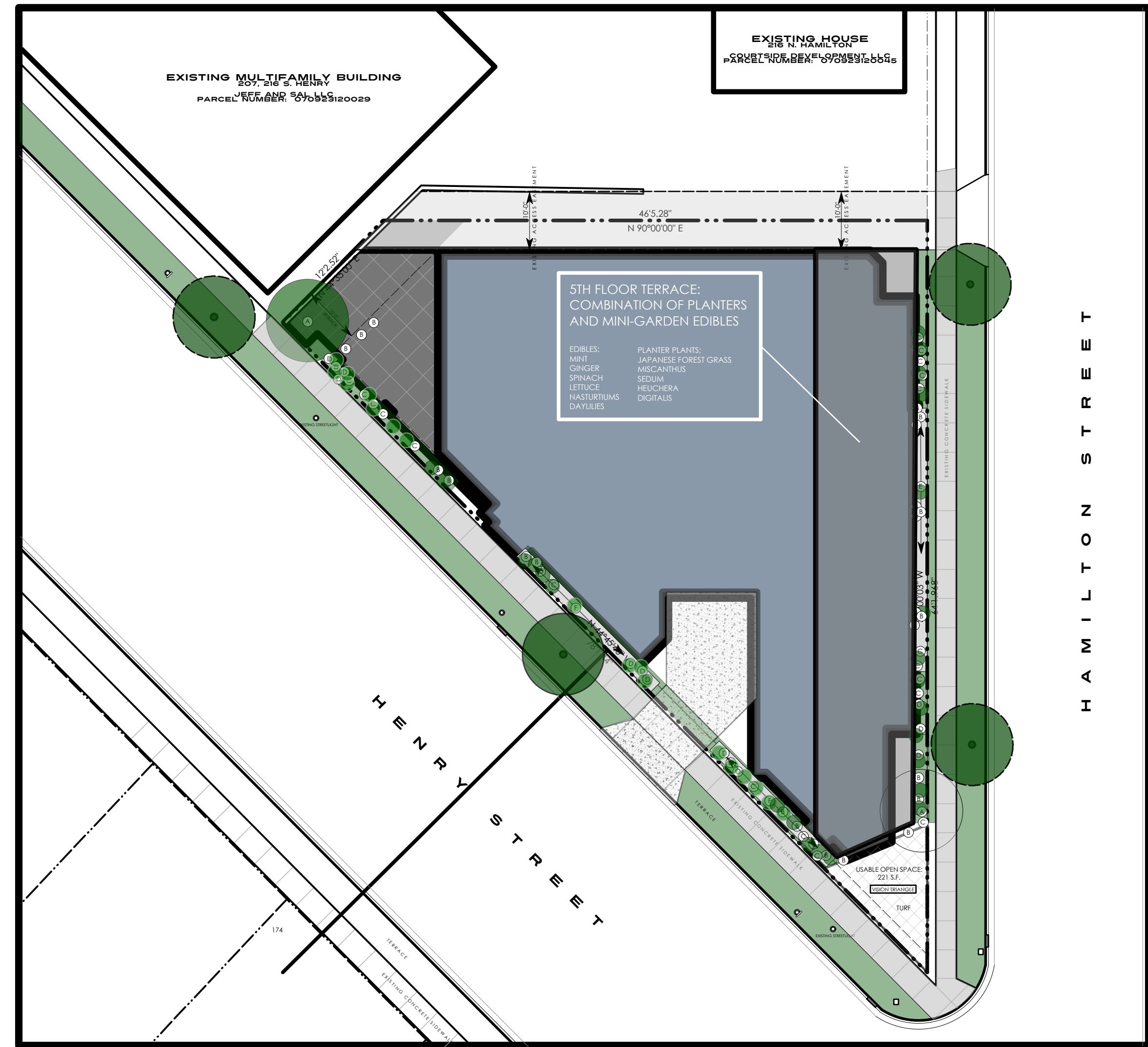

FIFTH FLOOR PLANTERS AND EDIBLE SPECIES

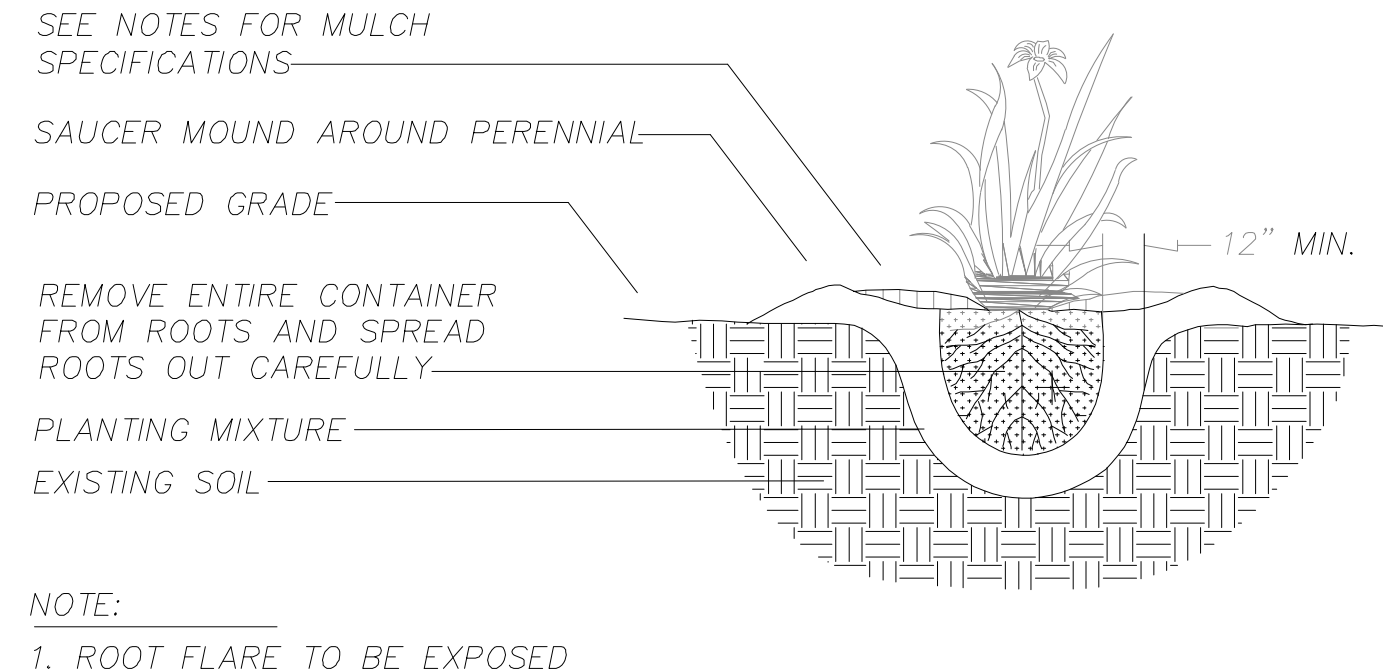
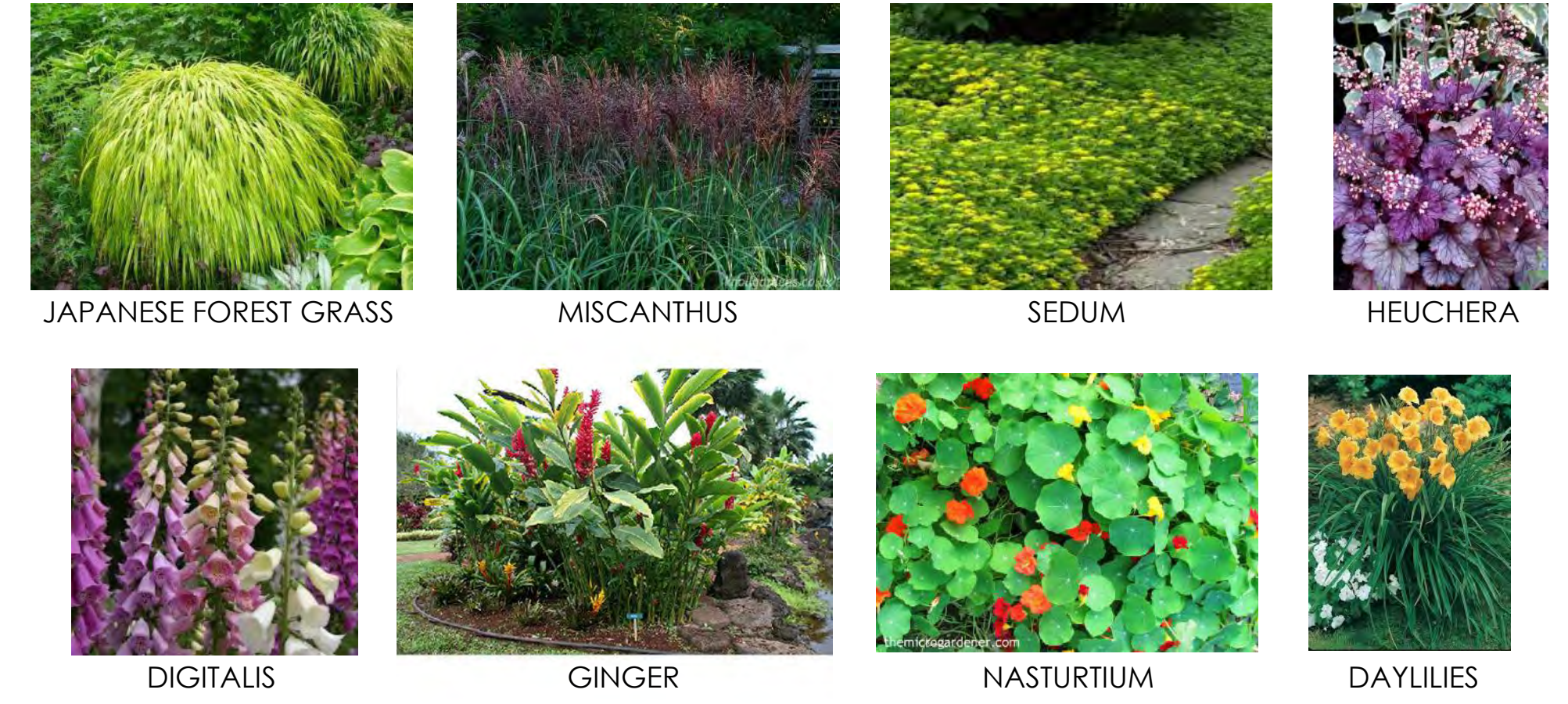

PERENNIAL/ORNAMENTAL GRASS PLANTING DETAIL

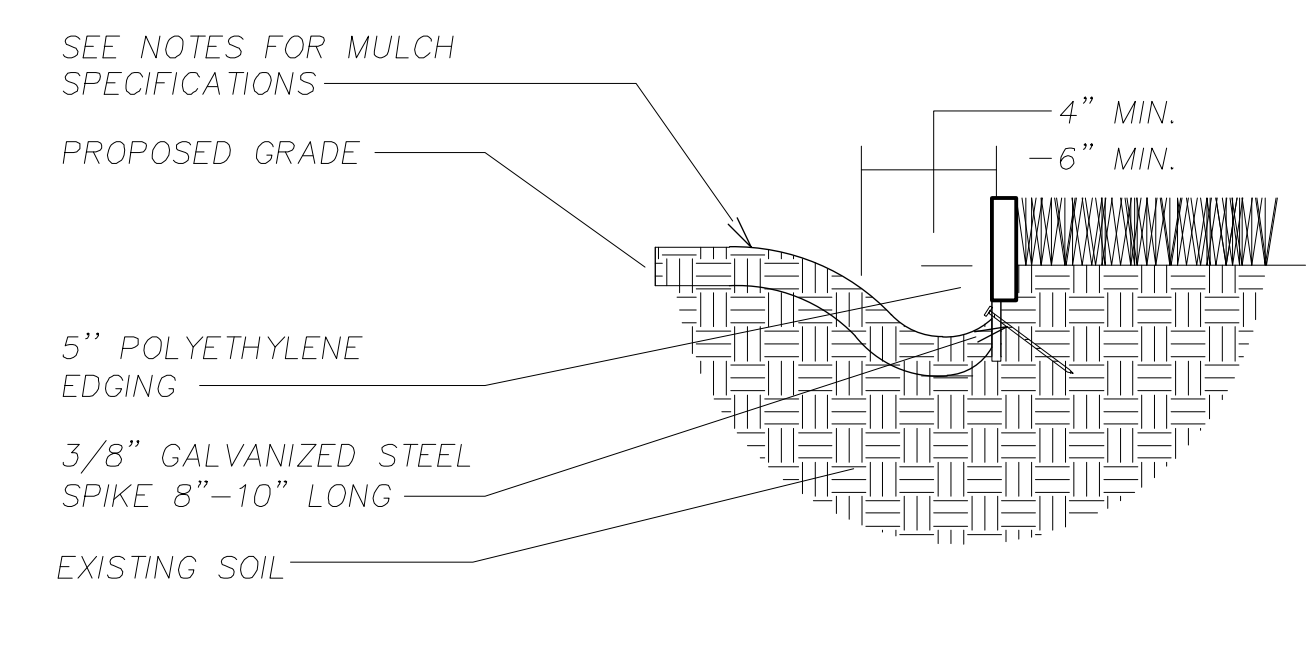

LANDSCAPE EDGING DETAIL

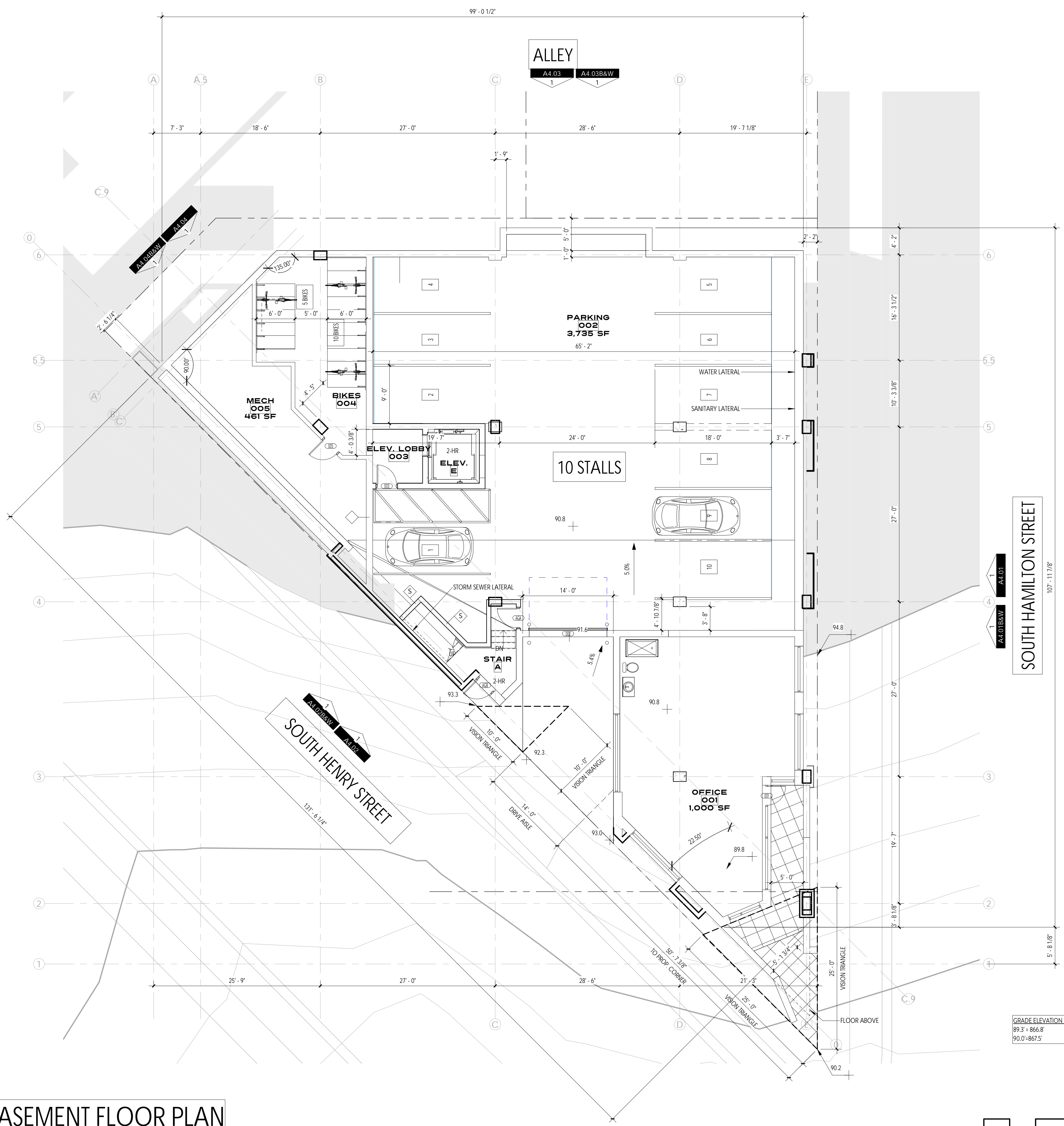

1 BASEMENT FLOOR PLAN
1/8" = 1'-0"

DRAWING NOTES

GRADE ELEVATION NOTE:
89.3' = 866.8'
90.0' = 867.5'

CODE NOTES

#	DATE	DESCRIPTION

UDC INFORMATIONAL

HENRY HAMILTON PARTNERS 104 KING STREET MADISON, WI 53703		DATE 07.18.18
THE BARRACUDA 222 S. HAMILTON MADISON, WI 53703		A1.00
GROUND FLOOR PLAN SCALE 1/8" = 1'-0"		

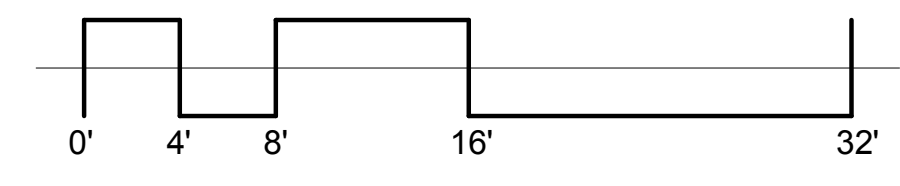

GRADE ELEVATION NOTE:
100.0' = 877.5'

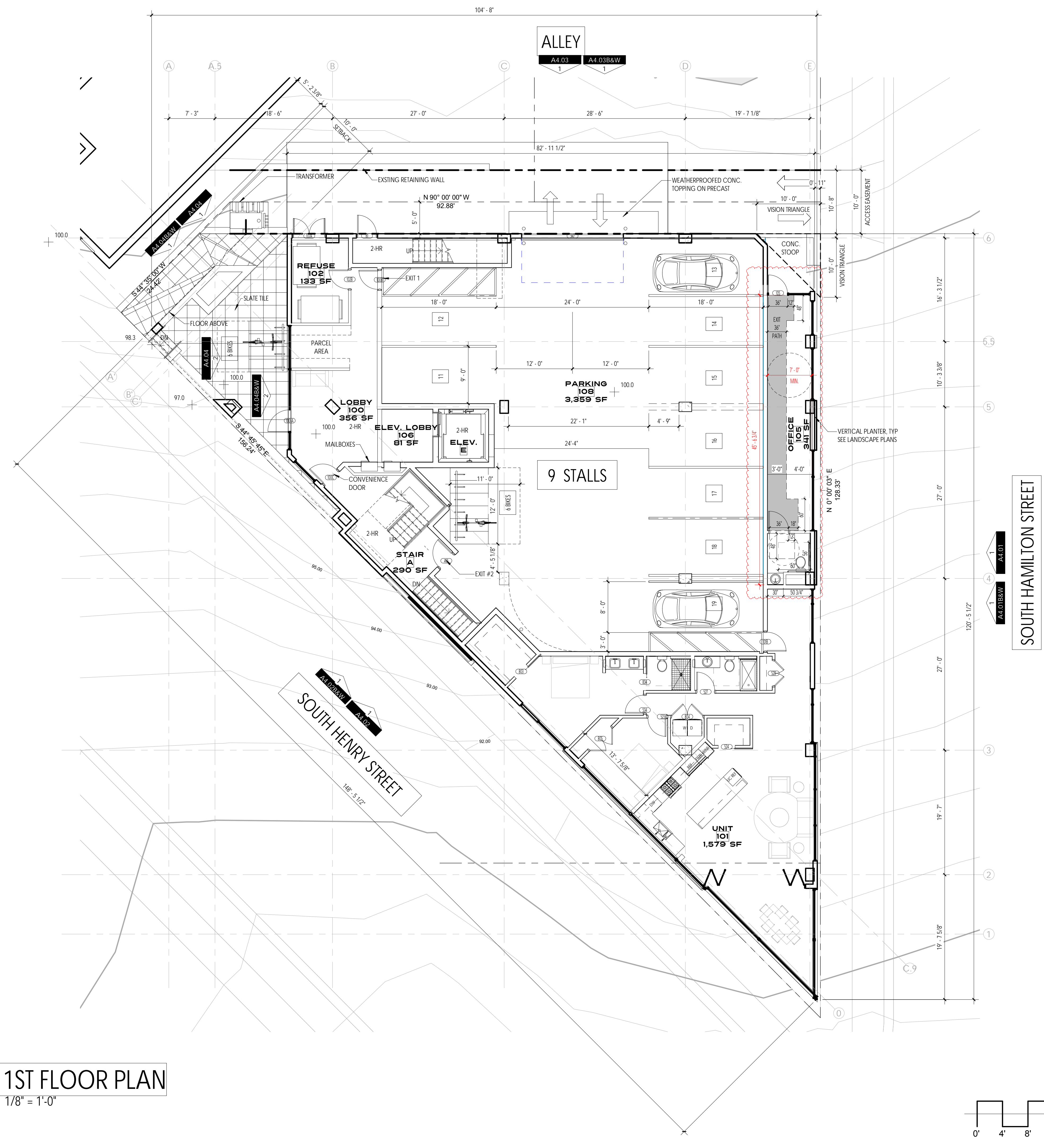

1 1ST FLOOR PLAN

1/8" = 1'-0"

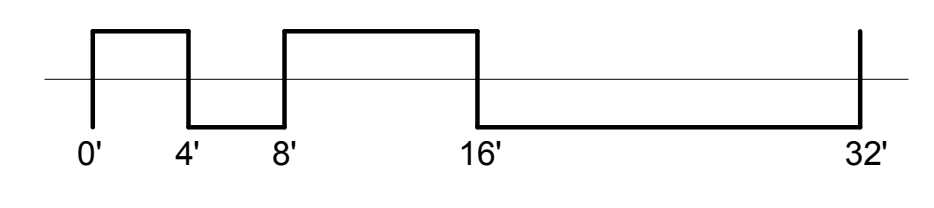

#	DATE	DESCRIPTION

PLAN COMMISSION

HENRY HAMILTON PARTNERS 104 KING STREET MADISON, WI 53703		DATE 07.18.18
THE BARRACUDA 222 S. HAMILTON MADISON, WI 53703		A1.01
FIRST FLOOR PLAN SCALE 1/8" = 1'-0"		

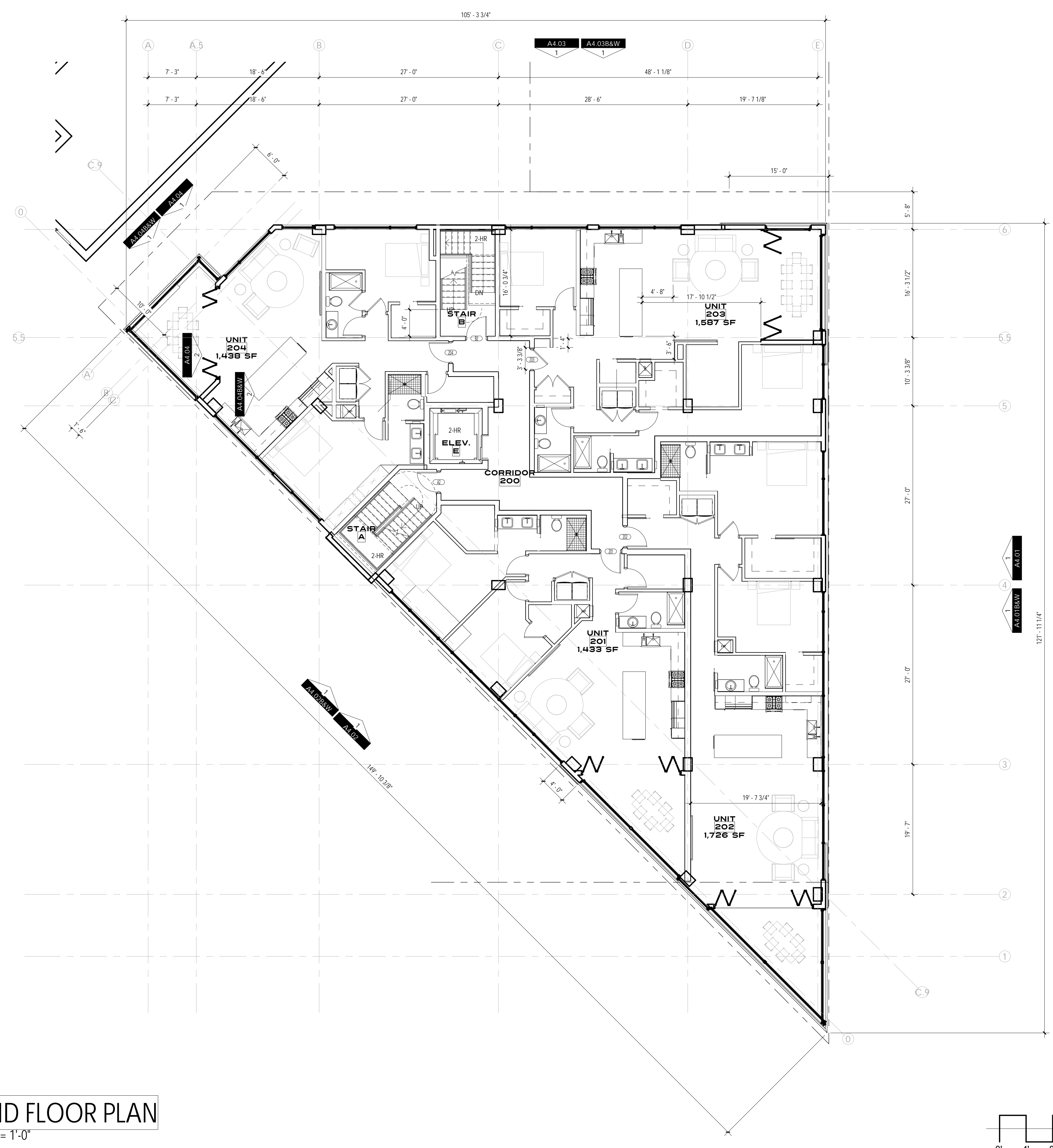

1 2ND FLOOR PLAN
1/8" = 1'-0"

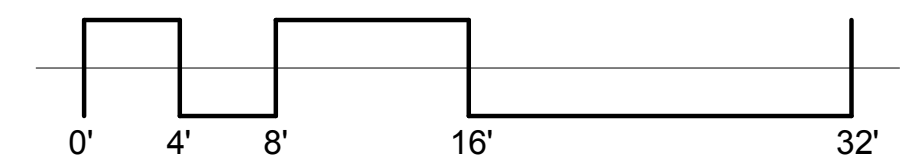

#	DATE	DESCRIPTION

UDC INFORMATIONAL

HENRY HAMILTON PARTNERS
104 KING STREET
MADISON, WI 53703

THE BARRACUDA
222 S. HAMILTON
MADISON, WI 53703

SECOND FLOOR PLAN
SCALE 1/8" = 1'-0"

DATE
07.18.18

A1.02

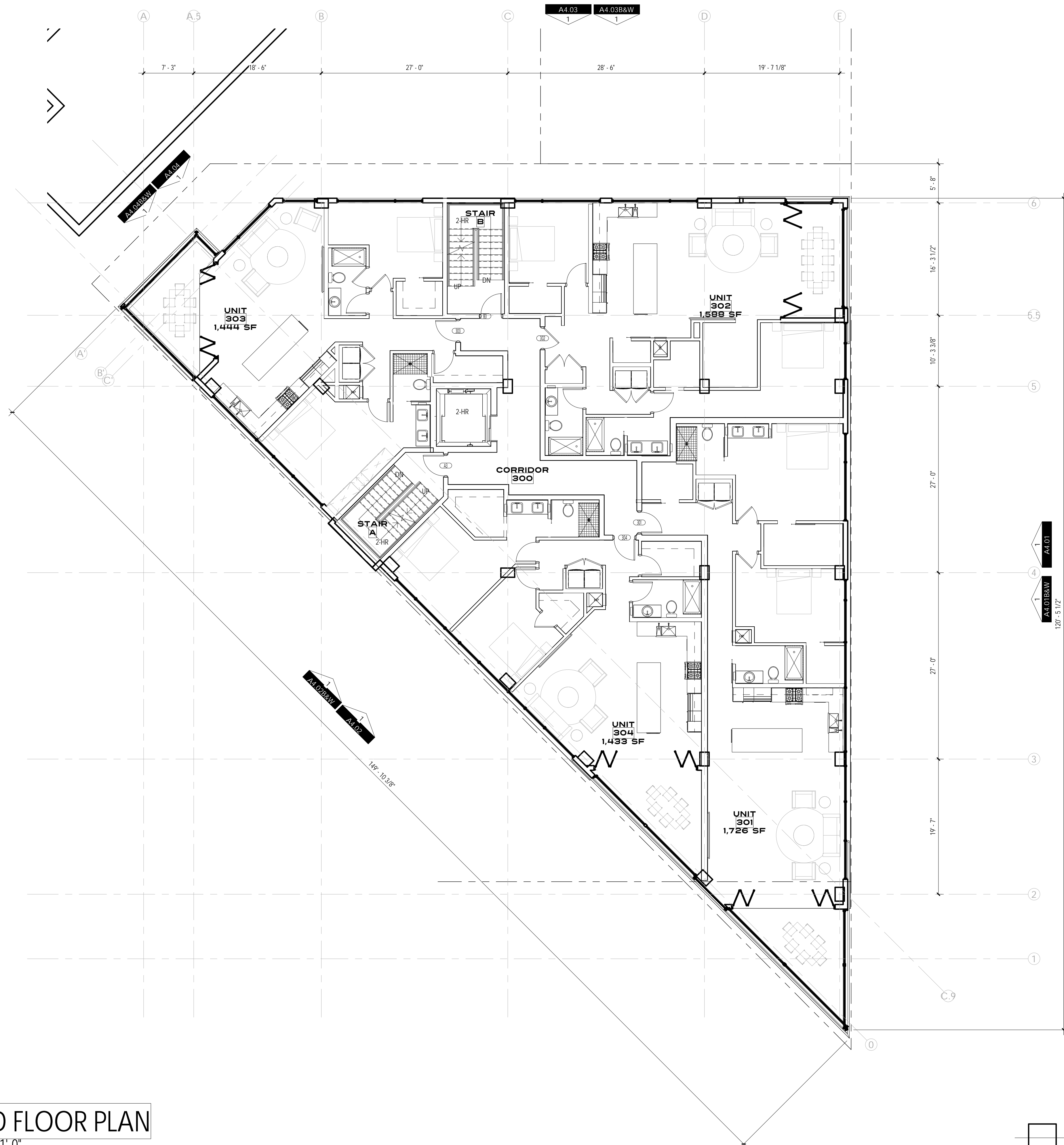

1 3RD FLOOR PLAN
1/8" = 1'-0"

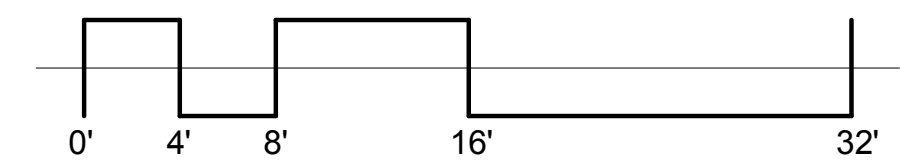

#	DATE	DESCRIPTION

UDC INFORMATIONAL

HENRY HAMILTON PARTNERS
104 KING STREET
MADISON, WI 53703

DATE
07.18.18

THE BARRACUDA
222 S. HAMILTON
MADISON, WI 53703

THIRD FLOOR PLAN

SCALE 1/8" = 1'-0"

A1.03

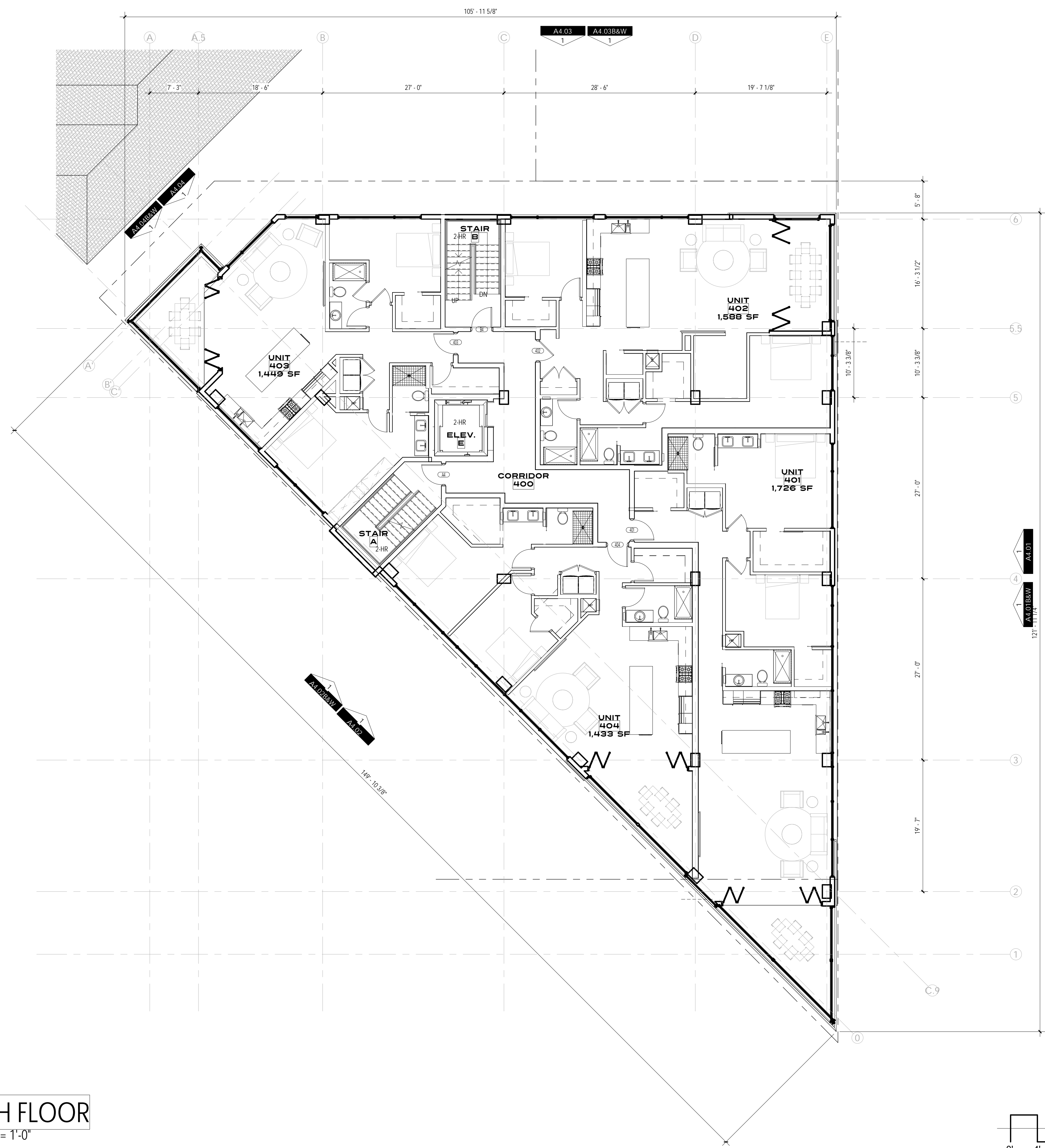

1 4TH FLOOR
1/8" = 1'-0"

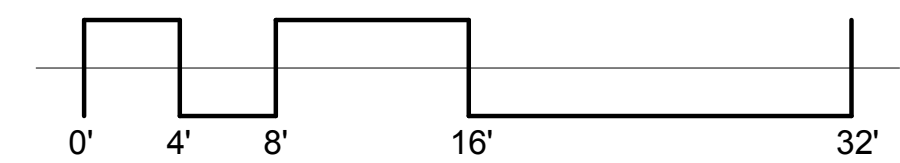

#	DATE	DESCRIPTION

UDC INFORMATIONAL

HENRY HAMILTON PARTNERS
104 KING STREET
MADISON, WI 53703

THE BARRACUDA
222 S. HAMILTON
MADISON, WI 53703

FOURTH FLOOR PLAN
SCALE 1/8" = 1'-0"

A1.04

DATE
07.18.18

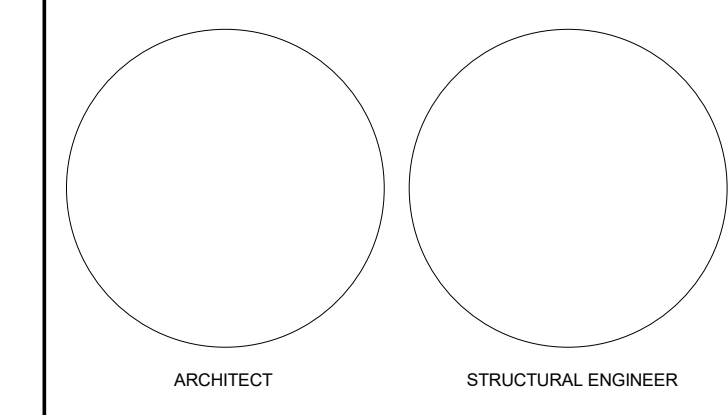

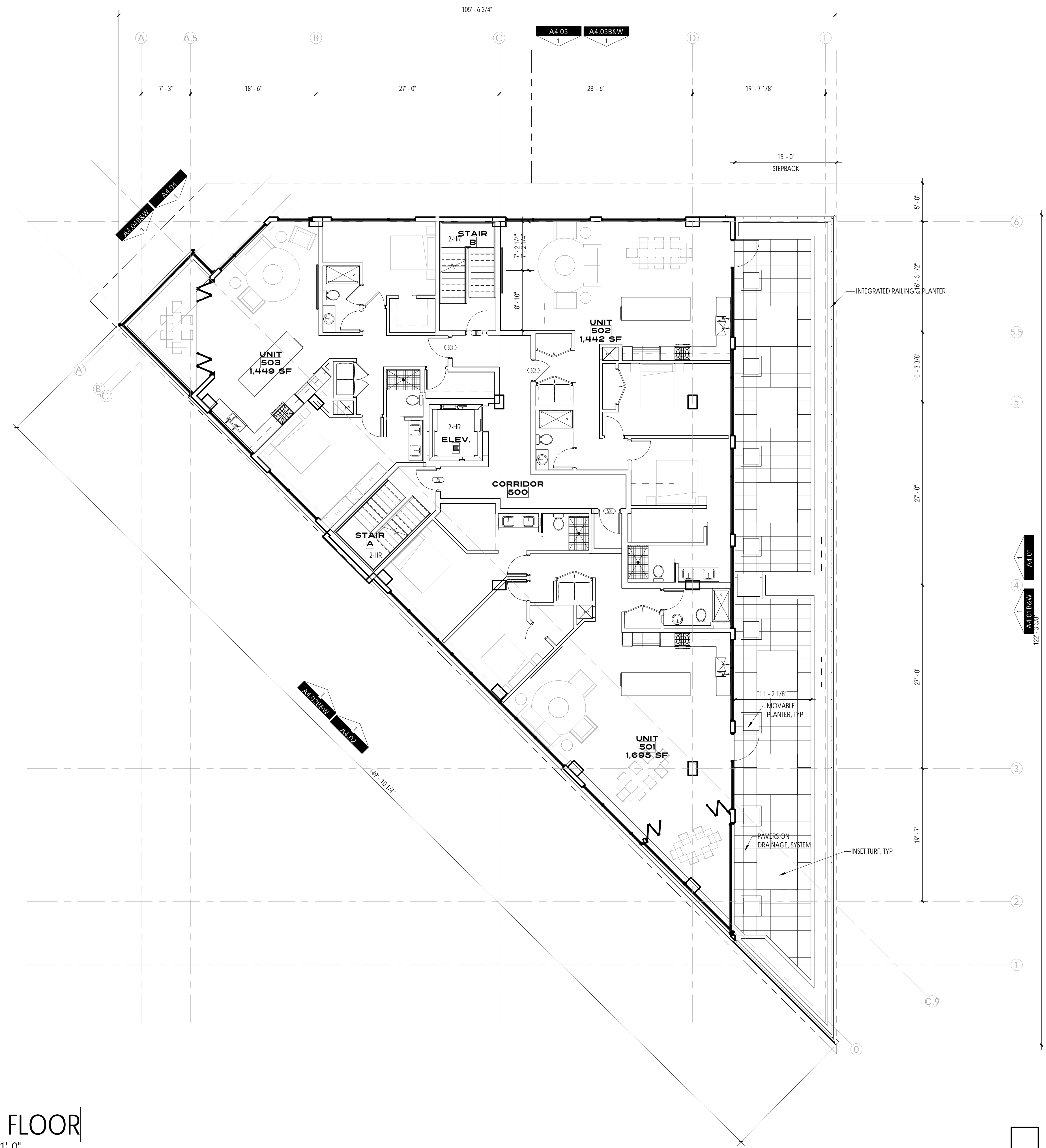

1 5TH FLOOR
1/8" = 1'-0"

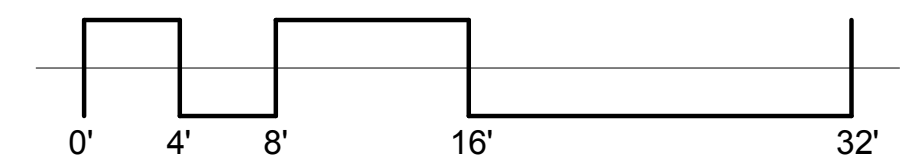

#	DATE	DESCRIPTION

UDC INFORMATIONAL

HENRY HAMILTON PARTNERS
104 KING STREET
MADISON, WI 53703

DATE
07.18.18

THE BARRACUDA
222 S. HAMILTON
MADISON, WI 53703

FIFTH FLOOR PLAN

SCALE 1/8" = 1'-0"

A1.05

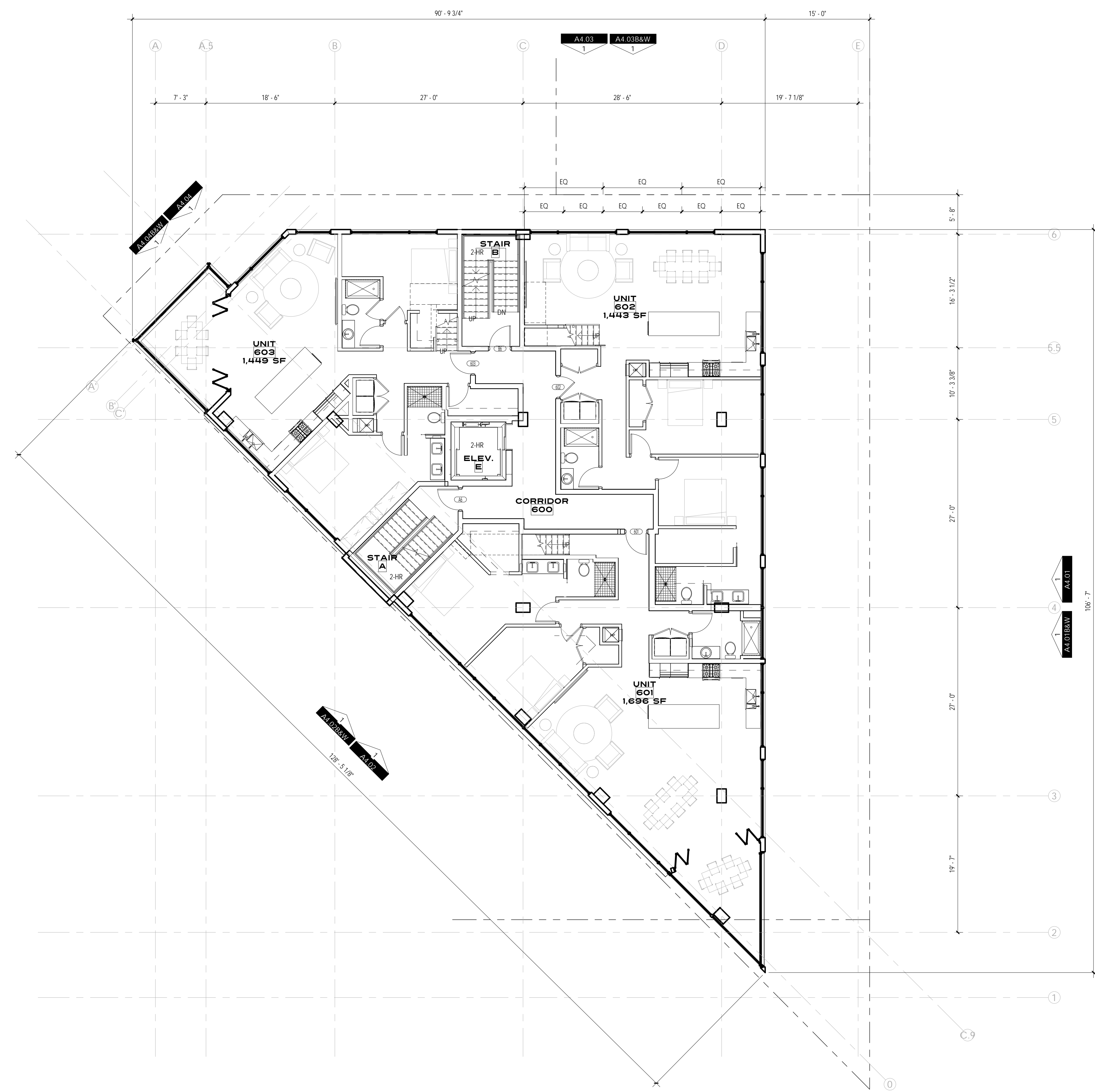

1 6TH FLOOR
1/8" = 1'-0"

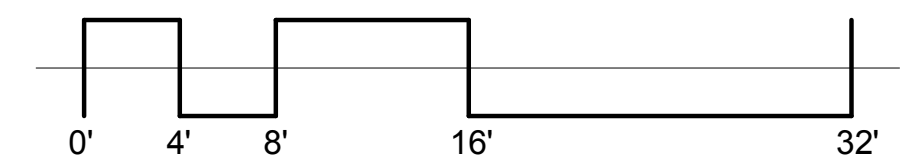

#	DATE	DESCRIPTION

UDC INFORMATIONAL

HENRY HAMILTON PARTNERS
104 KING STREET
MADISON, WI 53703

THE BARRACUDA
222 S. HAMILTON
MADISON, WI 53703

SIXTH FLOOR PLAN
SCALE 1/8" = 1'-0"

A1.06

DATE
07.18.18

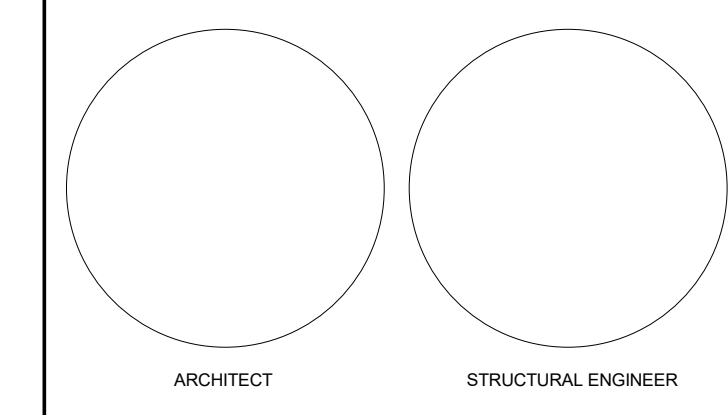



GENERAL NOTES



36" TALL PERFORATED, CORRUGATED AC CONDENSER SCREENING PANEL, GALVALUME

DRAWING NOTES

CODE NOTES

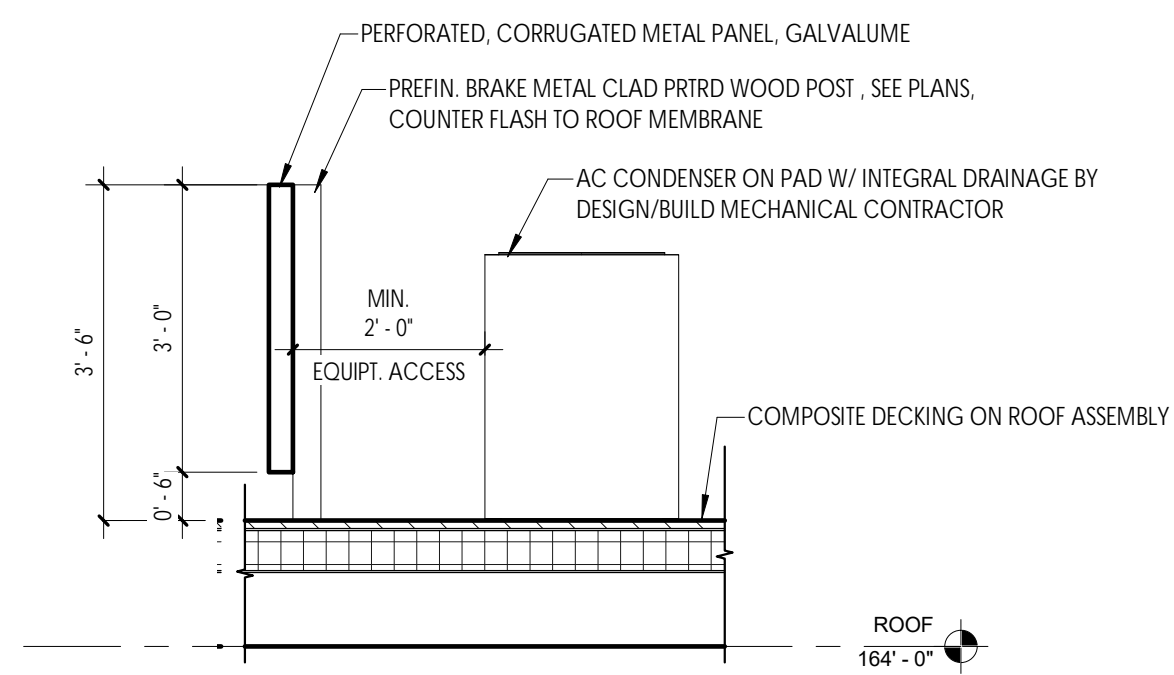

② AC CONDENSER SCREEN DETAIL
1/2" = 1'-0"

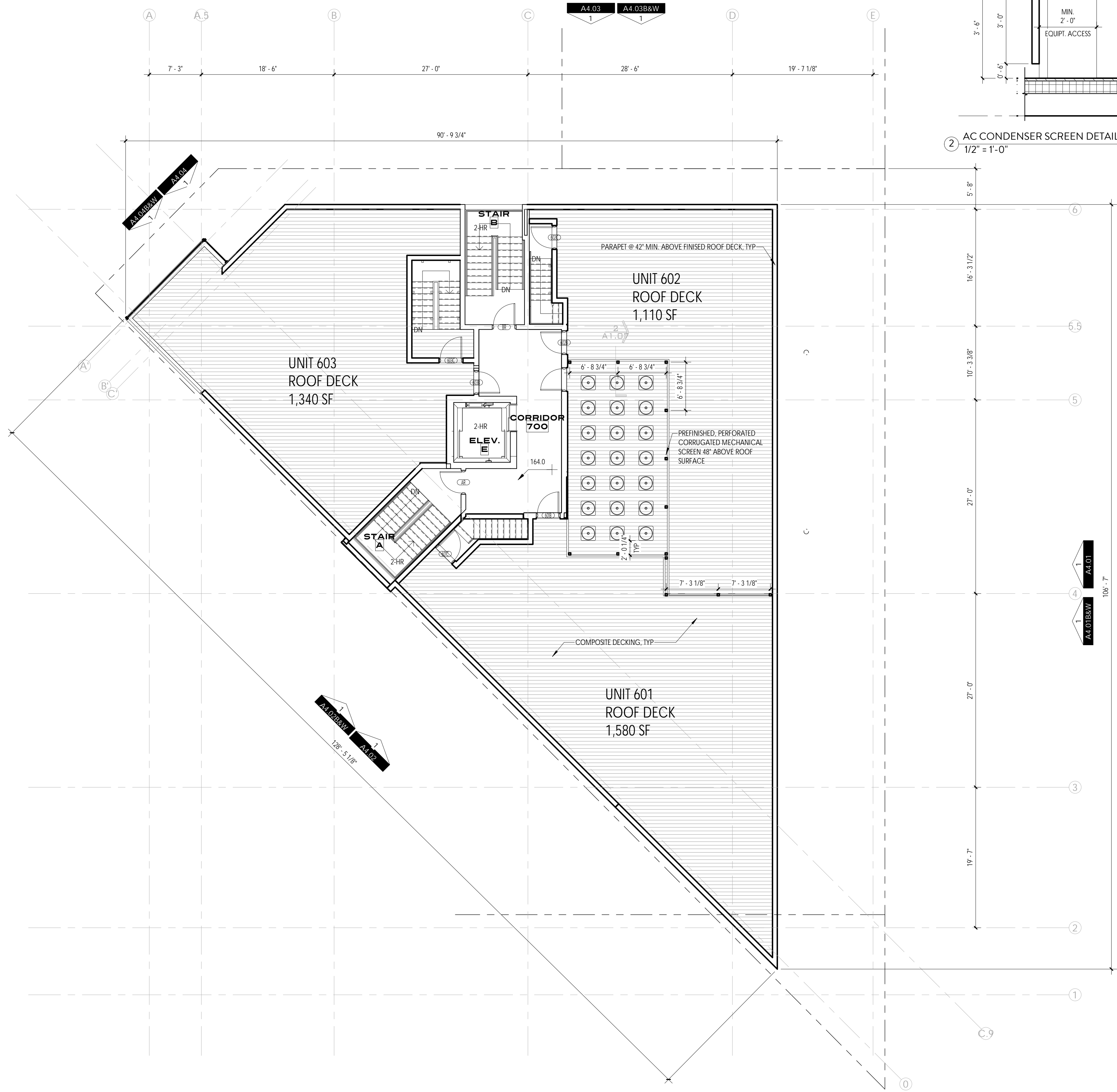

1 ROOF PLAN
1/8" = 1'-0"

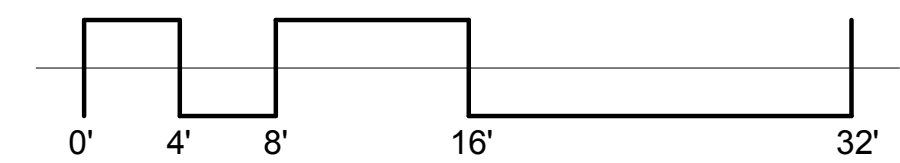

#	DATE	DESCRIPTION

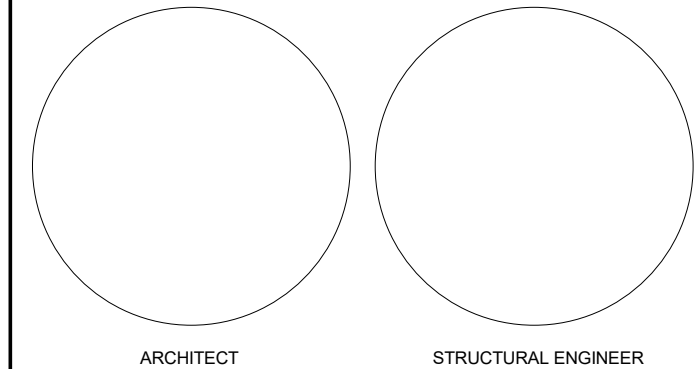

UDC INFORMATIONAL

HENRY HAMILTON PARTNERS
104 KING STREET
MADISON, WI 53703

DATE
07.18.18

THE BARRACUDA
222 S. HAMILTON
MADISON, WI 53703



ROOF PLAN

A1.07

SCALE AS INDICATED



1 HAMILTON STREET (EAST) ELEVATION
1/8" = 1'-0"

#	DATE	DESCRIPTION

UDC INFORMATIONAL

HENRY HAMILTON PARTNERS
104 KING STREET
MADISON, WI 53703

DATE
07.18.18

THE BARRACUDA
222 S. HAMILTON
MADISON, WI 53703
BUILDING ELEVATION-HAMILTON
STREET
SCALE 1/8" = 1'-0"

A4.01

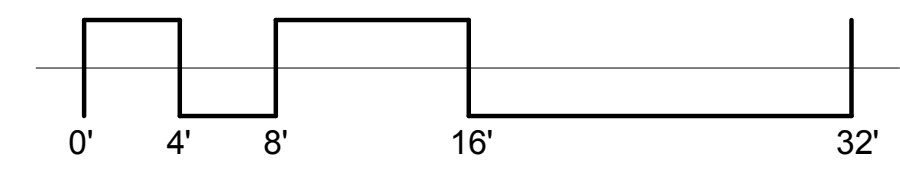

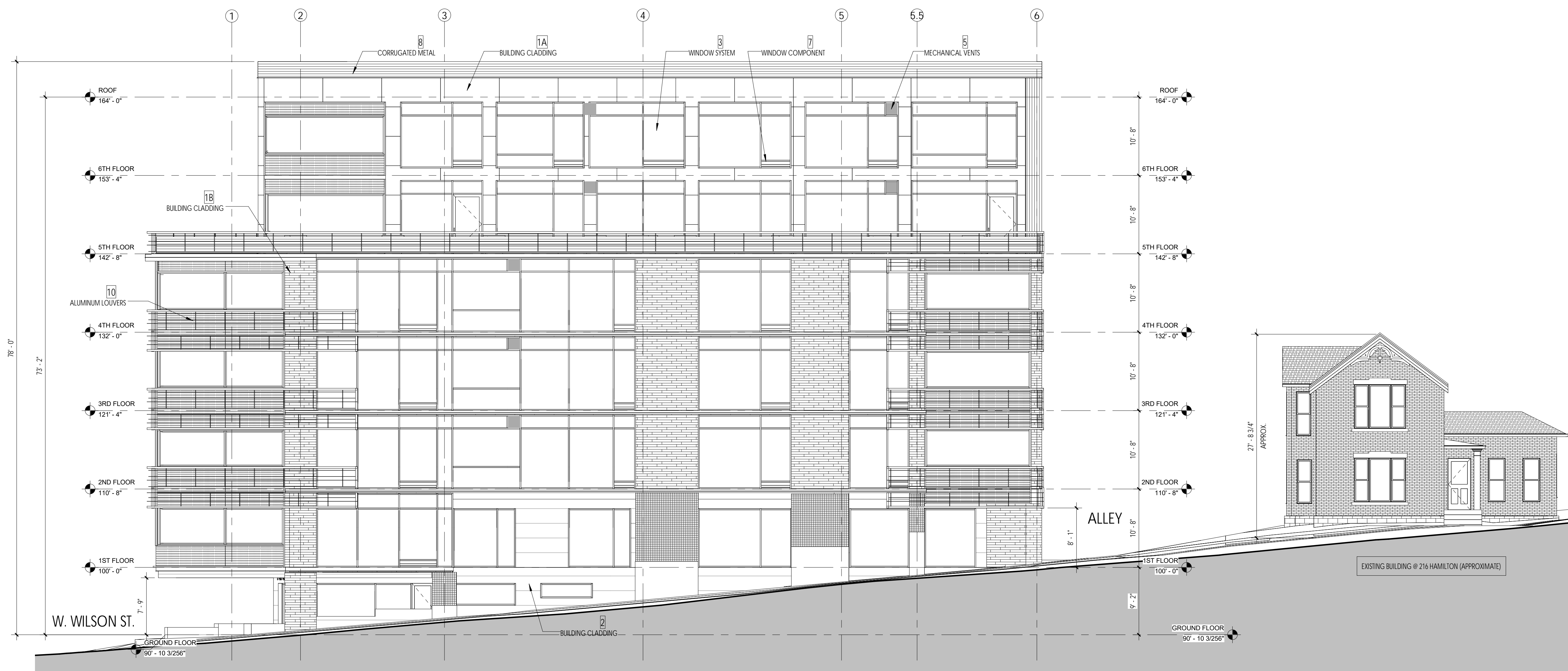

1 HAMILTON STREET (EAST) ELEVATION
1/8" = 1'-0"

#	DATE	DESCRIPTION

UDC INFORMATIONAL

HENRY HAMILTON PARTNERS
104 KING STREET
MADISON, WI 53703

DATE
07.18.18

THE BARRACUDA
222 S. HAMILTON
MADISON, WI 53703
BUILDING ELEVATION-HAMILTON STREET
SCALE 1/8" = 1'-0"

A4.01B&W

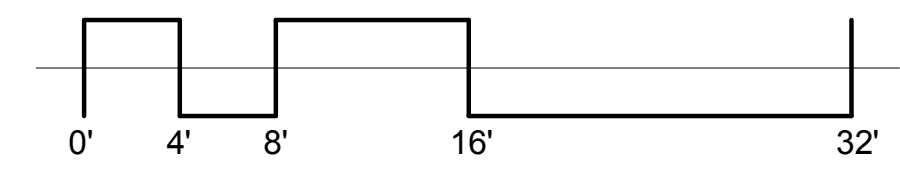



1 HENRY STREET (WEST) ELEVATION
1/8" = 1'-0"

#	DATE	DESCRIPTION

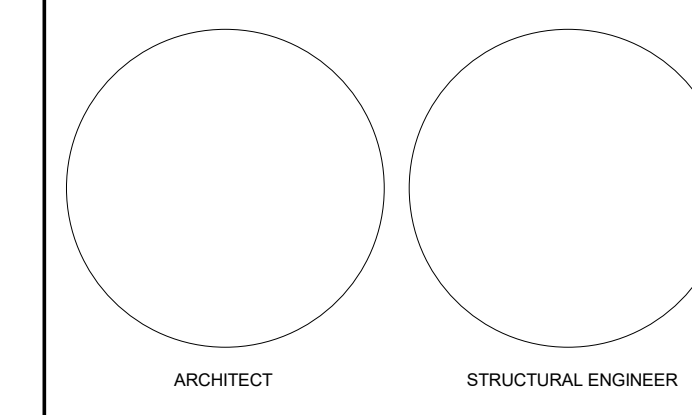

UDC INFORMATIONAL

HENRY HAMILTON PARTNERS
104 KING STREET
MADISON, WI 53703

THE BARRACUDA
222 S. HAMILTON
MADISON, WI 53703
BUILDING ELEVATION-HENRY
STREET
SCALE 1/8" = 1'-0"

DATE
07.18.18

A4.02

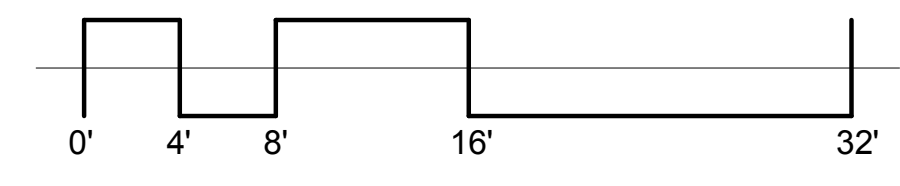



1 HENRY STREET (WEST) ELEVATION
1/8" = 1'-0"

#	DATE	DESCRIPTION

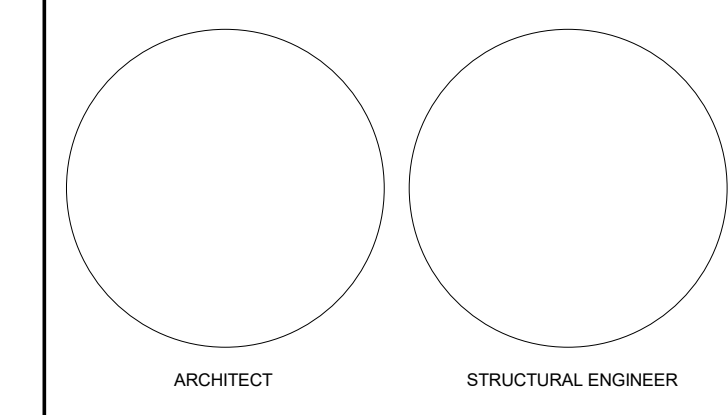

UDC INFORMATIONAL

HENRY HAMILTON PARTNERS
104 KING STREET
MADISON, WI 53703

DATE
07.18.18

THE BARRACUDA
222 S. HAMILTON
MADISON, WI 53703
BUILDING ELEVATION-HENRY STREET

A4.02B&W

SCALE 1/8" = 1'-0"



1 ALLEY (NORTH) ELEVATION
1/8" = 1'-0"

#	DATE	DESCRIPTION

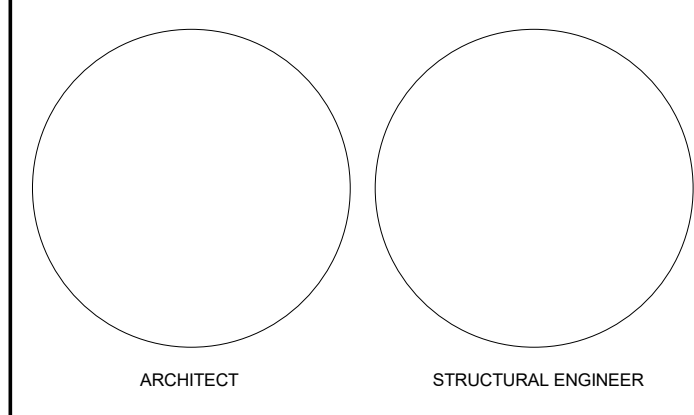

UDC INFORMATIONAL

HENRY HAMILTON PARTNERS
104 KING STREET
MADISON, WI 53703

DATE
07.18.18

THE BARRACUDA
222 S. HAMILTON
MADISON, WI 53703
BUILDING ELEVATION- NORTH
(ALLEY)
SCALE 1/8" = 1'-0"

A4.03

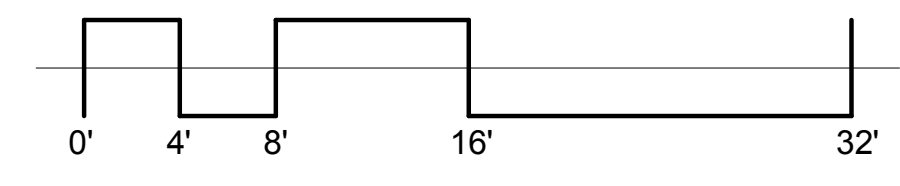

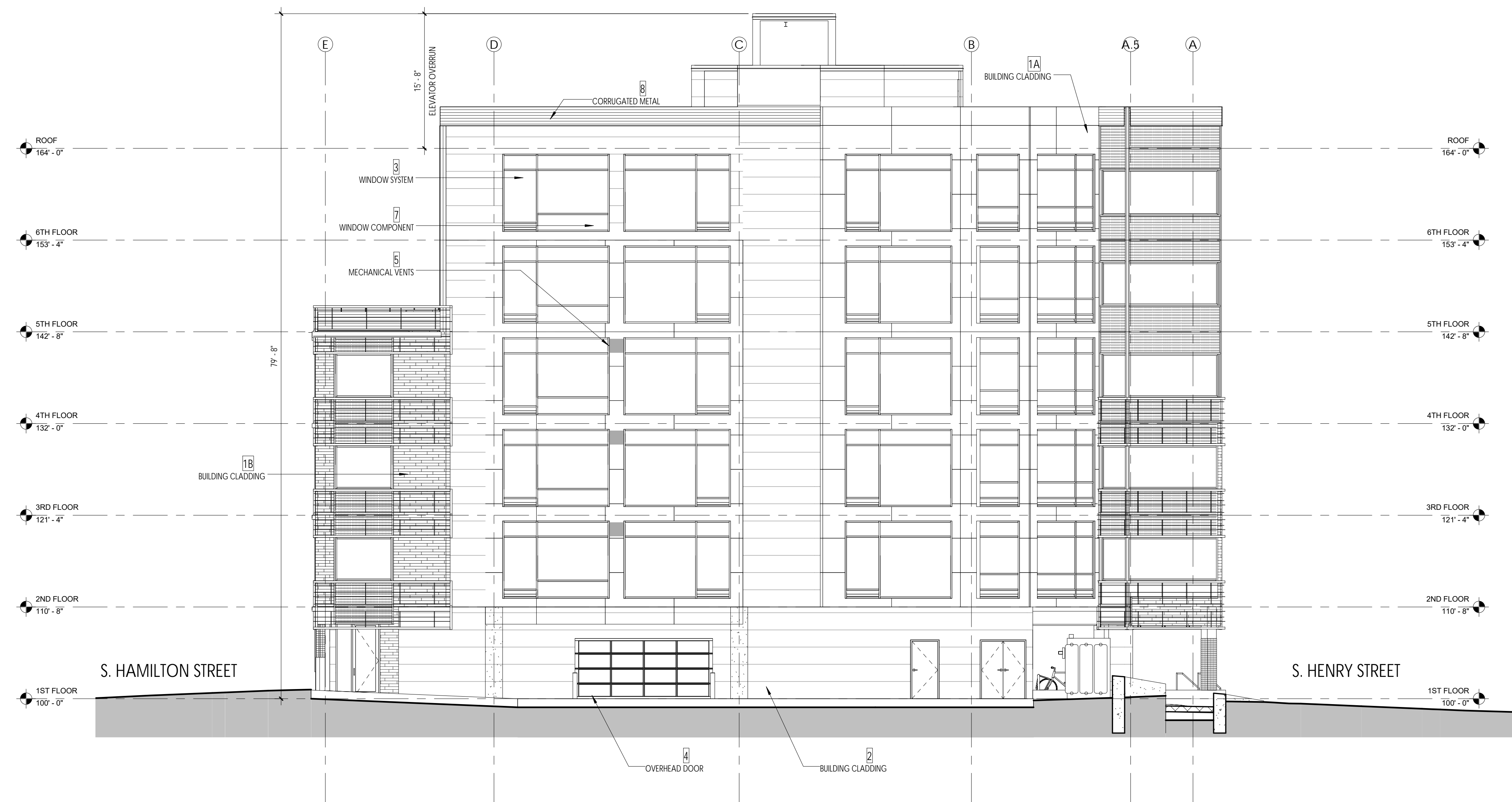

1 ALLEY (NORTH) ELEVATION
1/8" = 1'-0"

#	DATE	DESCRIPTION

UDC INFORMATIONAL

HENRY HAMILTON PARTNERS
104 KING STREET
MADISON, WI 53703

DATE
07.18.18

THE BARRACUDA
222 S. HAMILTON
MADISON, WI 53703
BUILDING ELEVATION- NORTH (ALLEY)
SCALE 1/8" = 1'-0"

A4.03B&W

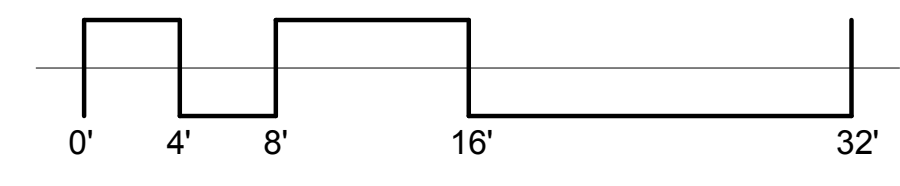

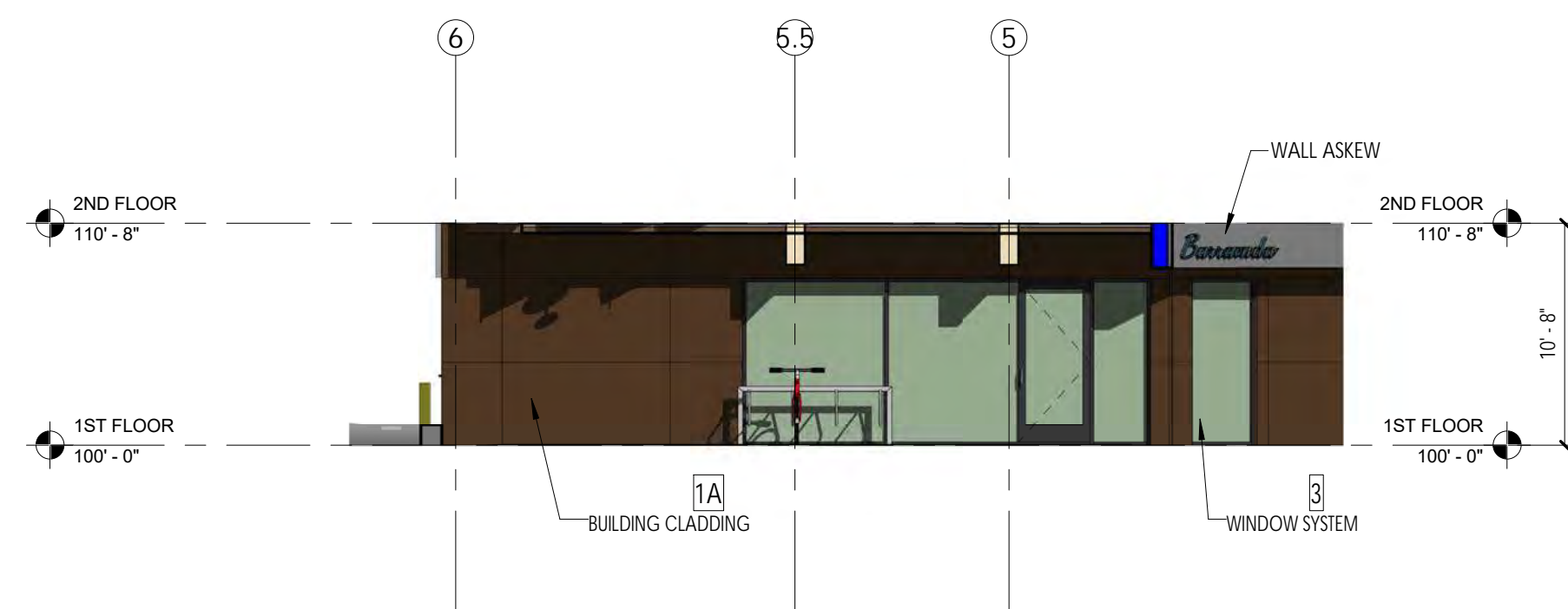

2 WEST ENTRY ELEVATION
1/8" = 1'-0"



1 NORTHWEST ELEVATION
1/8" = 1'-0"

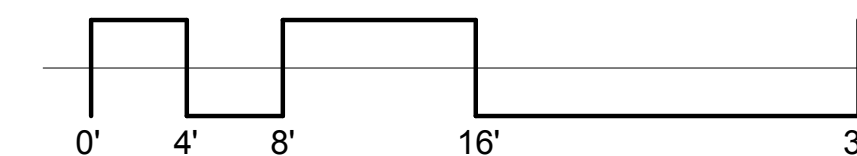

#	DATE	DESCRIPTION

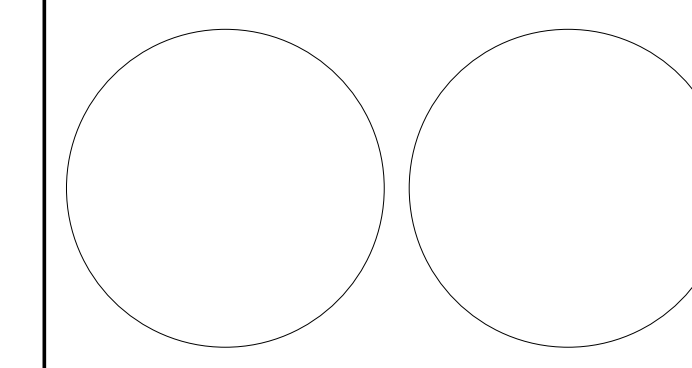

UDC INFORMATIONAL

HENRY HAMILTON PARTNERS
104 KING STREET
MADISON, WI 53703

DATE
07.18.18

THE BARRACUDA
222 S. HAMILTON
MADISON, WI 53703

BUILDING ELEVATIONS

A4.04

SCALE 1/8" = 1'-0"

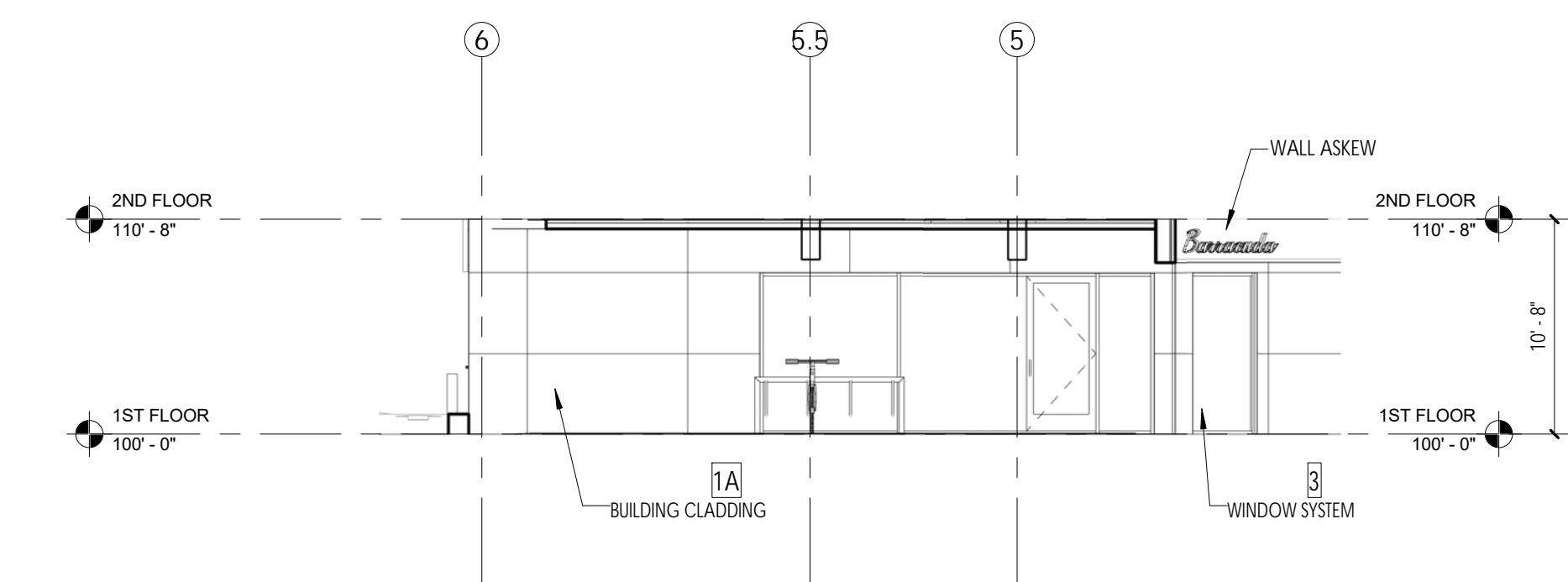

2 WEST ENTRY ELEVATION
1/8" = 1'-0"

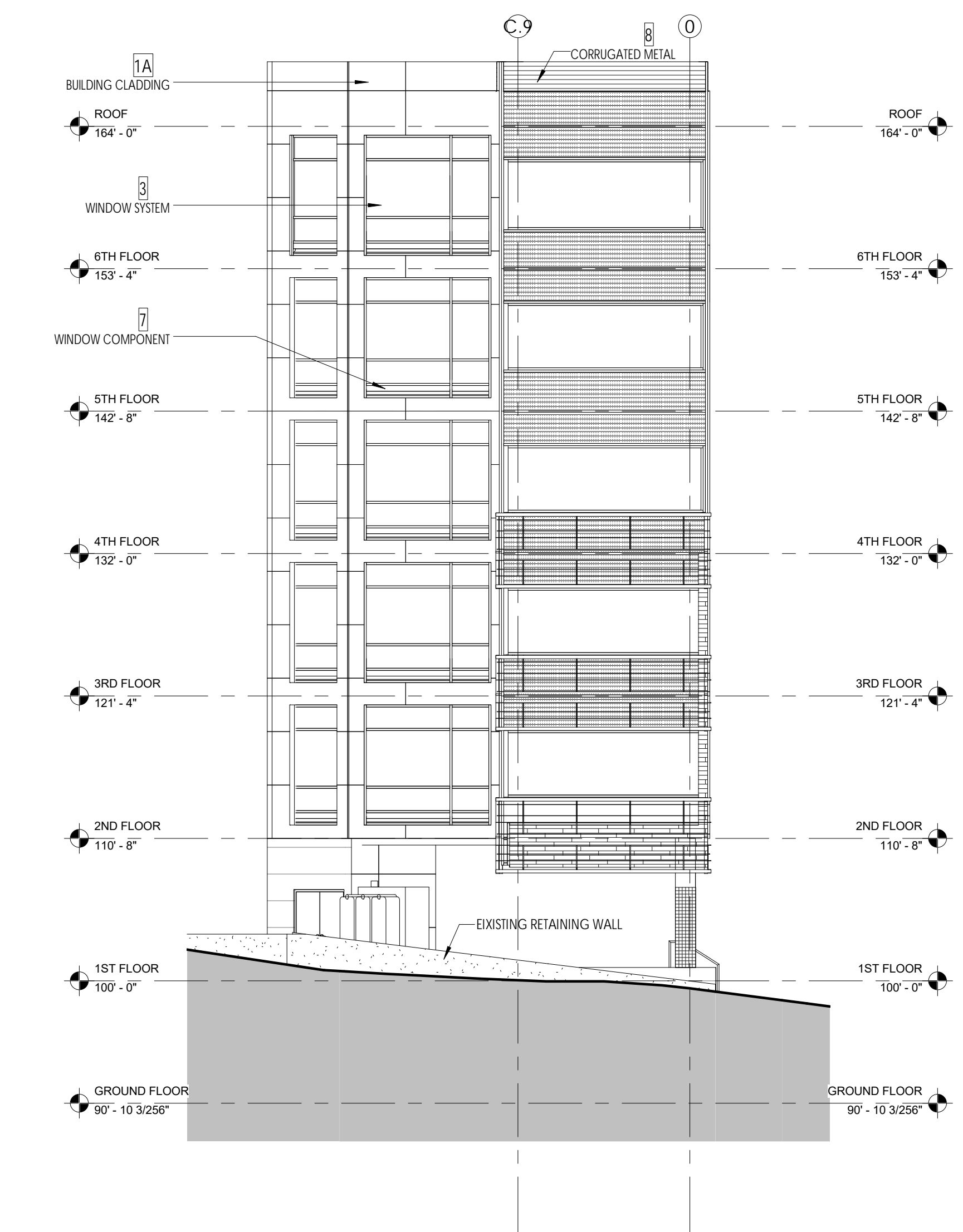

1 NORTHWEST ELEVATION
1/8" = 1'-0"

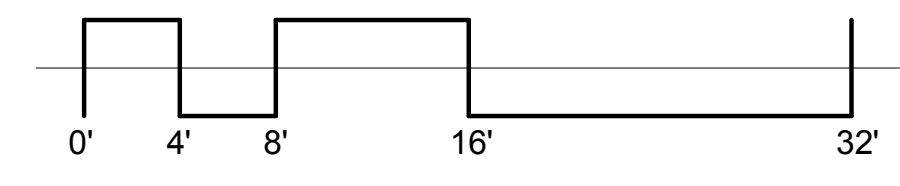

#	DATE	DESCRIPTION

UDC INFORMATIONAL

HENRY HAMILTON PARTNERS
104 KING STREET
MADISON, WI 53703

DATE
07.18.18

THE BARRACUDA
222 S. HAMILTON
MADISON, WI 53703

BUILDING ELEVATIONS

A4.04B&W

SCALE 1/8" = 1'-0"

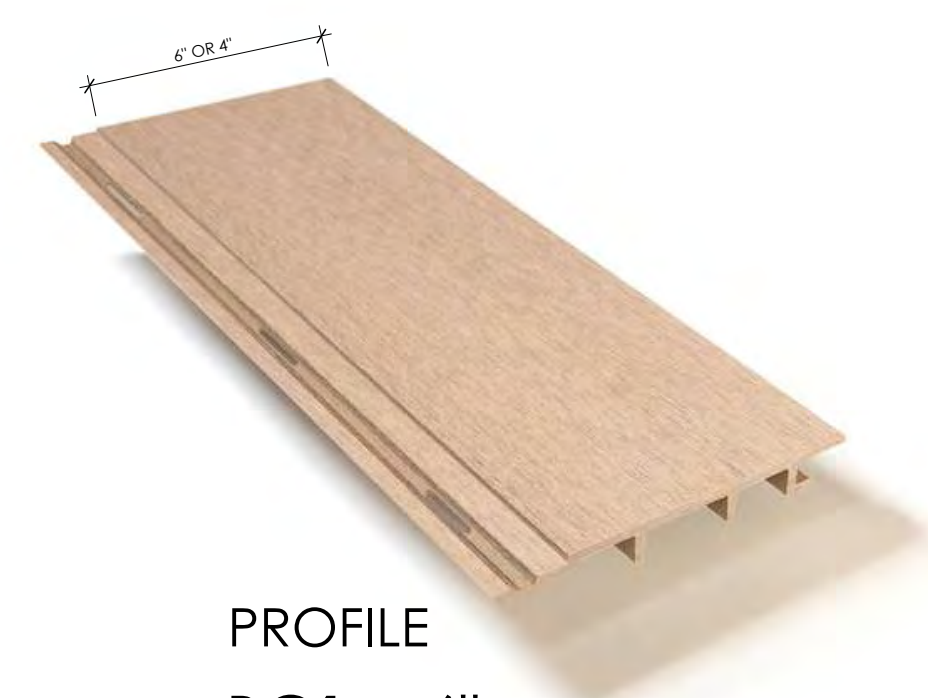

PROFILE
BC1 = 6"
BC2 = 4"

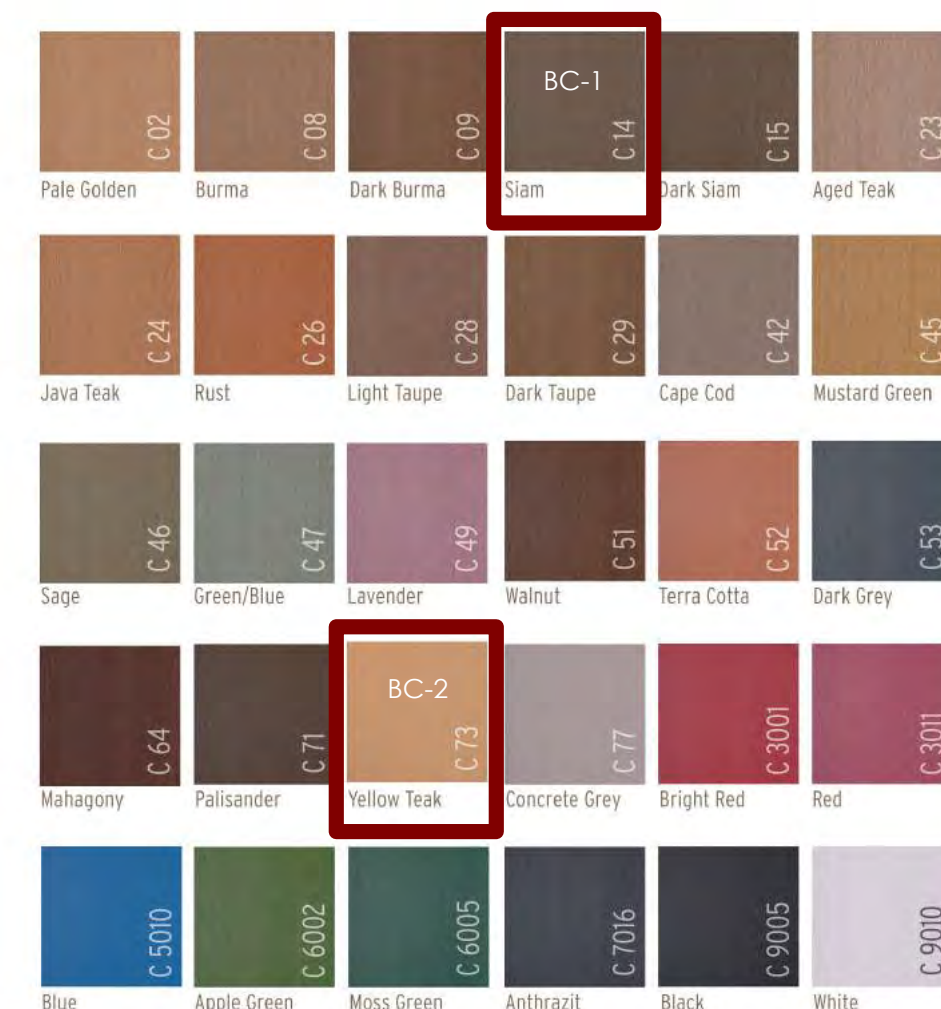
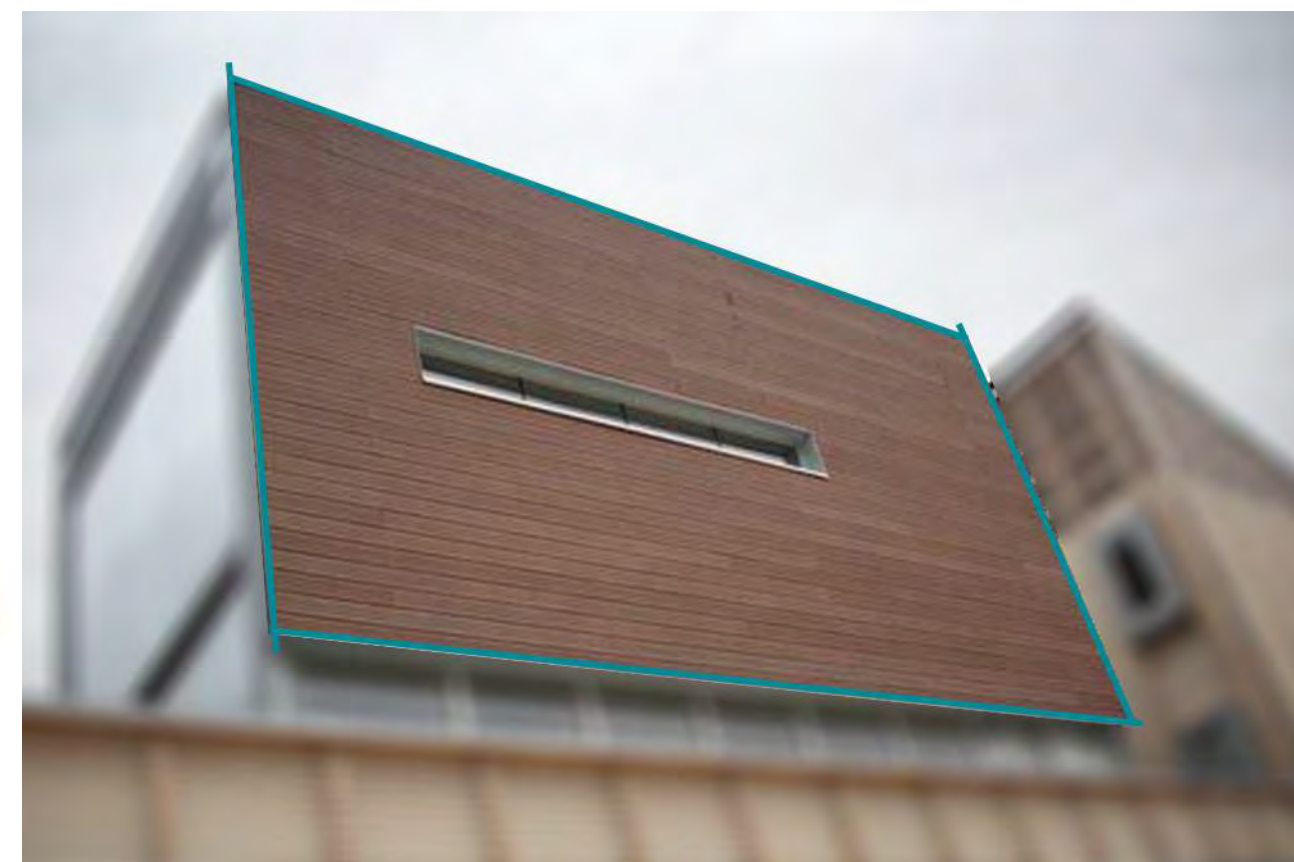

COLOR PALETTE

1 BUILDING CLADDING (2 TYPES)

LOCATION: EXTERIOR
MATERIAL: COMPOSITE WOOD
FASTENERS: CONCEALED
CORNERS: MITERED
DURABILITY: EXCELLENT
FLAME SPREAD RATING: CLASS A <=25
COLOR FADING & GREYING: N/A

1A:
SIZE: 4" EXPOSED; RANDOM LENGTHS
COLOR: YELLOW TEAK

1B:
SIZE: 6" EXPOSED; RANDOM LENGTHS
COLOR: SIAM

2 BUILDING CLADDING

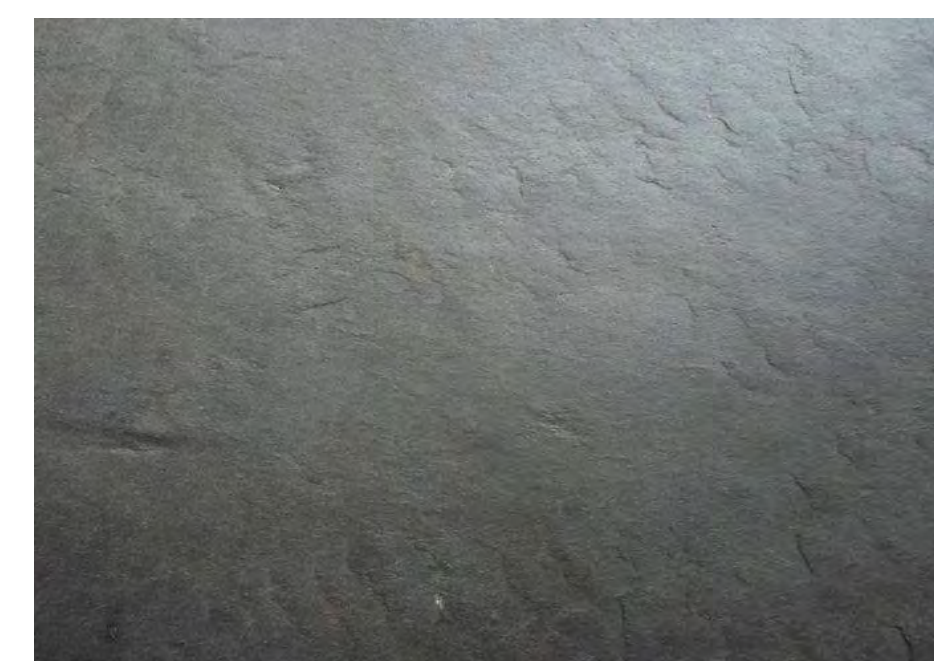

LOCATION: EXTERIOR
MATERIAL: SLATE PANELS
SIZE: 36"W X 24" H PANELS
FASTENERS: CONCEALED
CORNERS: MITERED
DURABILITY: EXCELLENT
FLAME SPREAD RATING: CLASS A <=25
COLOR FADING & GREYING: MINIMAL

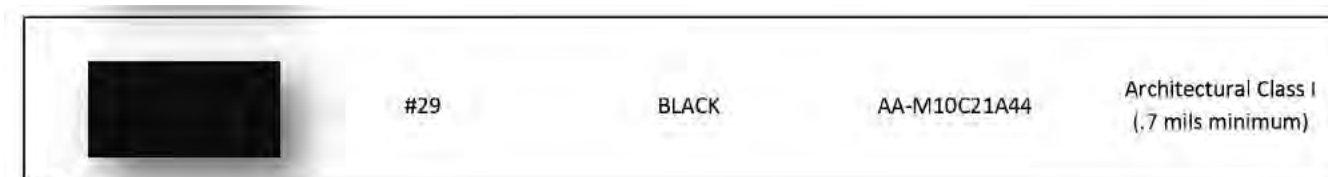

3 WINDOW SYSTEM

LOCATION: EXTERIOR
MATERIAL:
FRAME: THERMALLY BROKEN ANODIZED ALUMINUM, BLACK
GLASS: CLEAR DOUBLE PANE LOW-E
DURABILITY: EXCELLENT
WINDOW COVERING: SMART GLASS ELECTROCHROMATIC FILM
GLASS COLOR:
1: RANGES FROM CLEAR TO OPAQUE (WHITE)
2: SPANDREL GLASS (DARK GREY)



4 OVERHEAD DOORS

LOCATION: EXTERIOR
MATERIAL:
FRAME: ANODIZED ALUMINUM, BLACK
GLASS: WHITE INSULATED
DURABILITY: EXCELLENT



BATH EXHAUST



KITCHEN EXHAUST

5 VENTS

LOCATION: EXTERIOR
MATERIAL:
FRAME: BRUSHED ALUMINUM
DURABILITY: EXCELLENT

DATE	DESCRIPTION

UDC INFORMATIONAL

HENRY HAMILTON PARTNERS
225 S. HAMILTON STREET
MADISON, WI 53703

DATE
07.18.18

THE BARRACUDA
225 S. HAMILTON STREET
MADISON, WI 53703

A5.01



6 BUILDING CLADDING

LOCATION: EXTERIOR AT HENRY ST. PARKING ENTRY
 MATERIAL: SYNTHETIC TURF-RENEWABLE SOYBEANS AND DENSE POLYETHYLENE THATCH COMBINED W/OLYETHYLENE MONOFILAMENT GRASS BLADES
 FASTENERS: CONCEALED
 CORNERS: FRAMED
 DURABILITY: EXCELLENT
 FLAME SPREAD RATING: CLASS A <=25
 COLOR FADING & GREYING: N/A

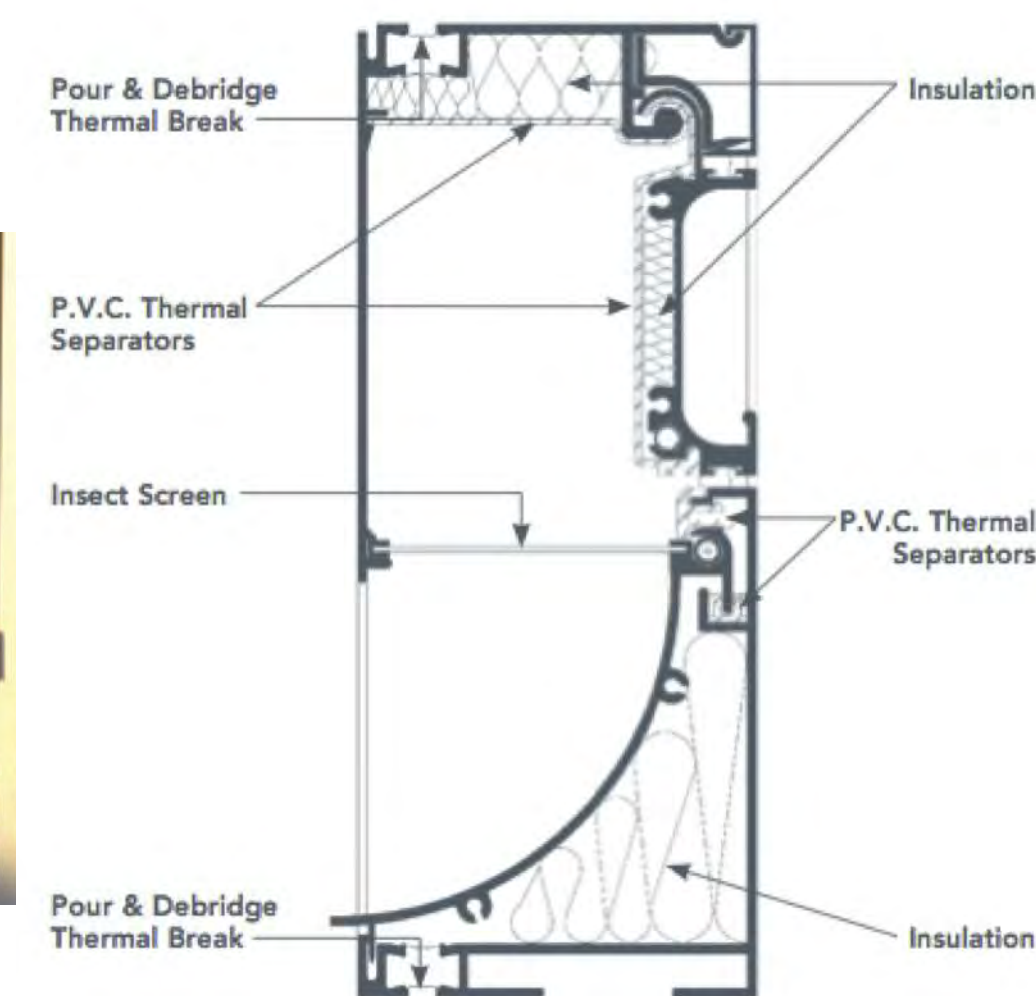
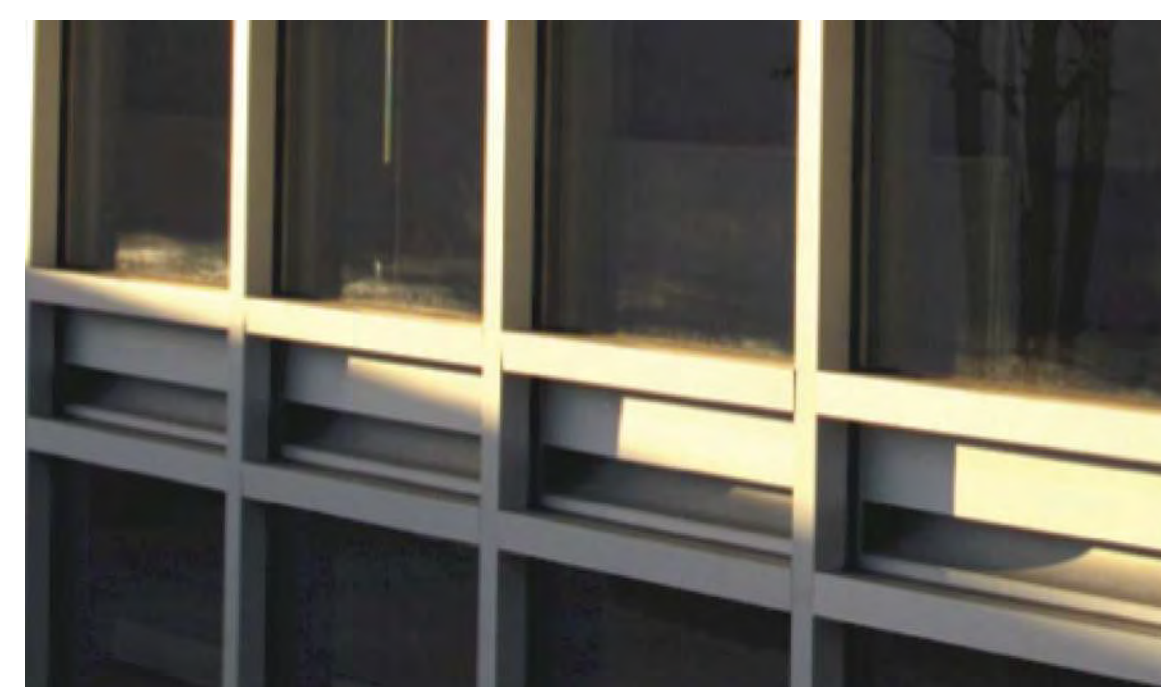

7 WINDOW COMPONENT

LOCATION: ERESIDENTIAL WINDOWS
 MATERIAL: SINTEGRAL ALUMINUM NATURAL AIR VENT
 FASTENERS: CONCEALED
 CORNERS: FRAMED
 DURABILITY: EXCELLENT
 COLOR FADING & GREYING: N/A

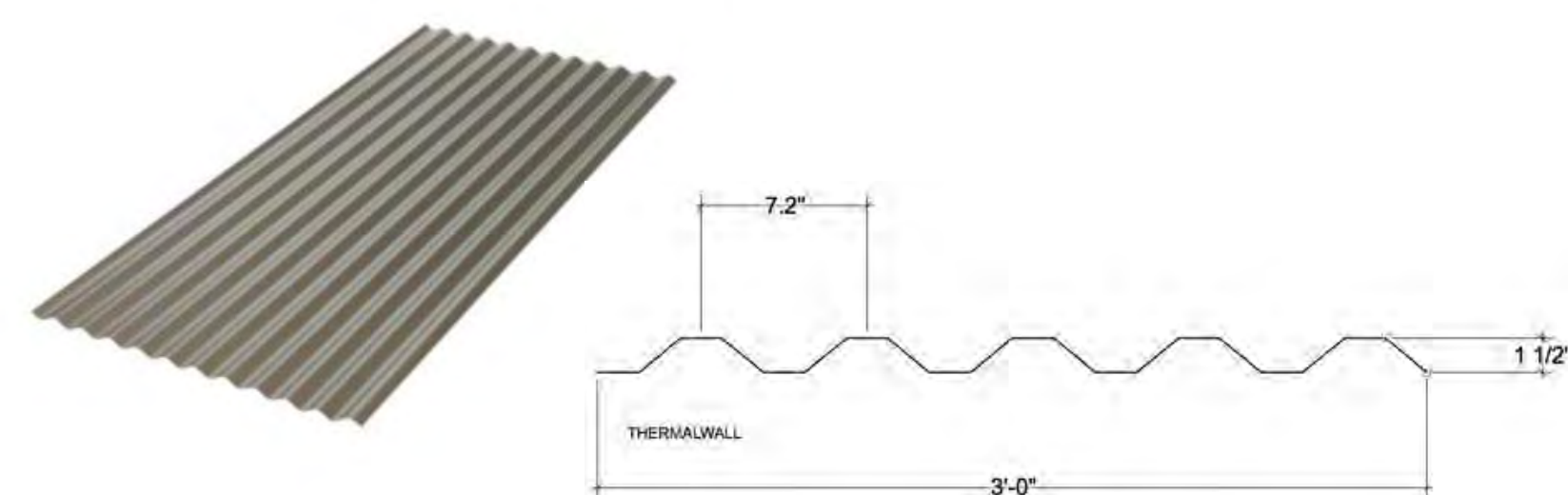

8 PARAPET METAL

LOCATION: 6H FLOOR PARAPET
 MATERIAL: STEEL
 FASTENERS: CONCEALED
 CORNERS: FRAMED
 DURABILITY: EXCELLENT
 COLOR FADING & GREYING: N/A

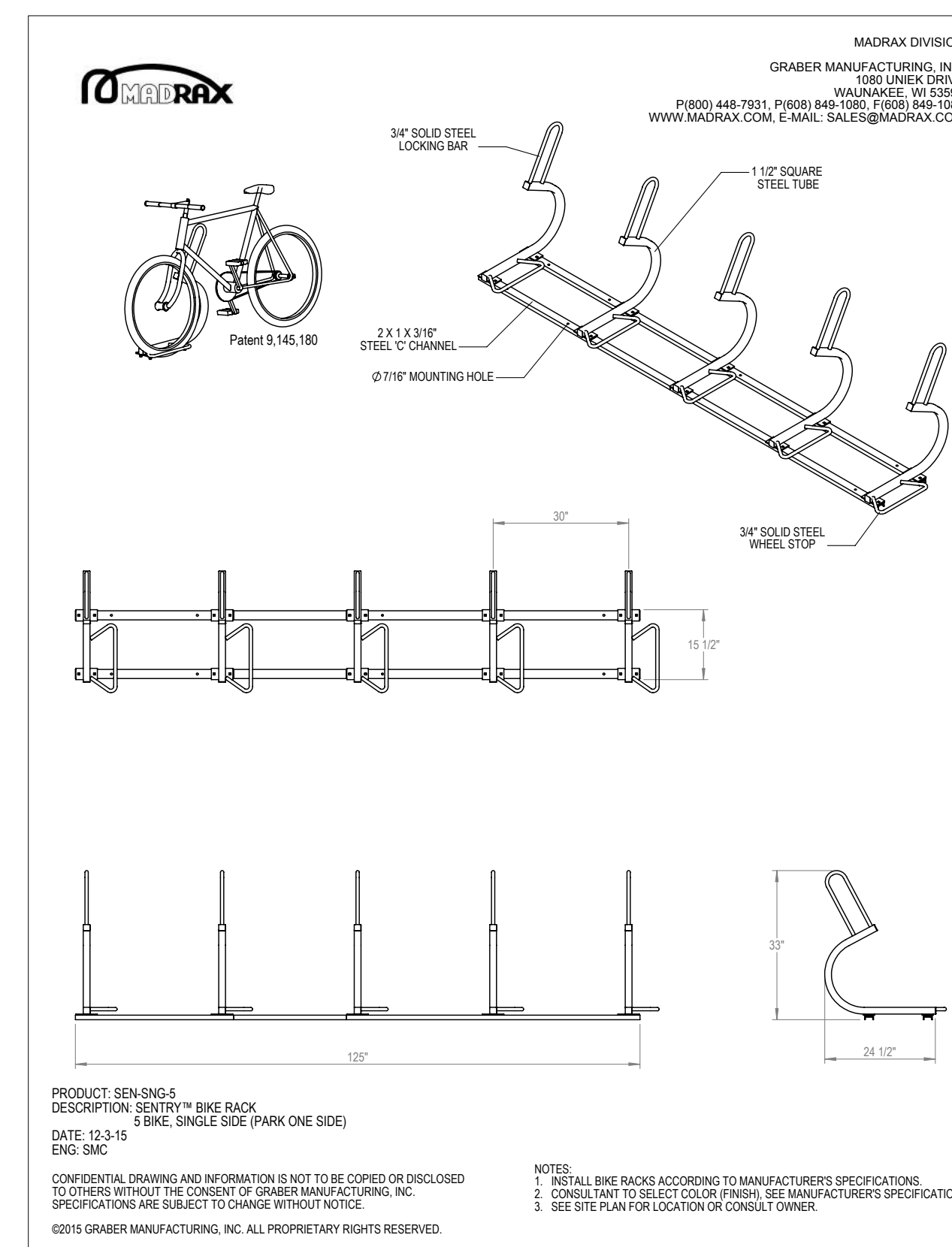

TYPICAL BICYCLE RACK

UDC INFORMATIONAL

HENRY HAMILTON PARTNERS
 101 KING STREET
 MADISON, WI 53703

DATE
 07.18.18

THE BARRACUDA
 222 S. HAMILTON
 MADISON, WI 53703

A5.02

BUILDING MATERIALS



UDC INFORMATIONAL

HENRY HAMILTON PARTNERS
101 KING STREET
MADISON, WI 53703

DATE
07.18.18

THE BARRACUDA
222 S. HAMILTON
MADISON, WI 53703

A5.03

RENDERINGS

AA

AB

AC

AD

AE

AF

AG



UDC INFORMATIONAL

HENRY HAMILTON PARTNERS
101 KING STREET
MADISON, WI 53703

DATE
07.18.18

THE BARRACUDA
222 S. HAMILTON
MADISON, WI 53703

A5.04

RENDERINGS



UDC INFORMATIONAL

HENRY HAMILTON PARTNERS
101 KING STREET
MADISON, WI 53703

DATE
07.18.18

THE BARRACUDA
222 S. HAMILTON
MADISON, WI 53703

A5.05

RENDERINGS



HENRY ENTRY



HAMILTON STREETScape



OFFICE ENTRY

UDC INFORMATIONAL

HENRY HAMILTON PARTNERS
101 KING STREET
MADISON, WI 53703

DATE
07.18.18

THE BARRACUDA
222 S. HAMILTON
MADISON, WI 53703

A5.06

RENDERINGS



HAMILTON ELEVATION



HAMILTON STREETSCAPE

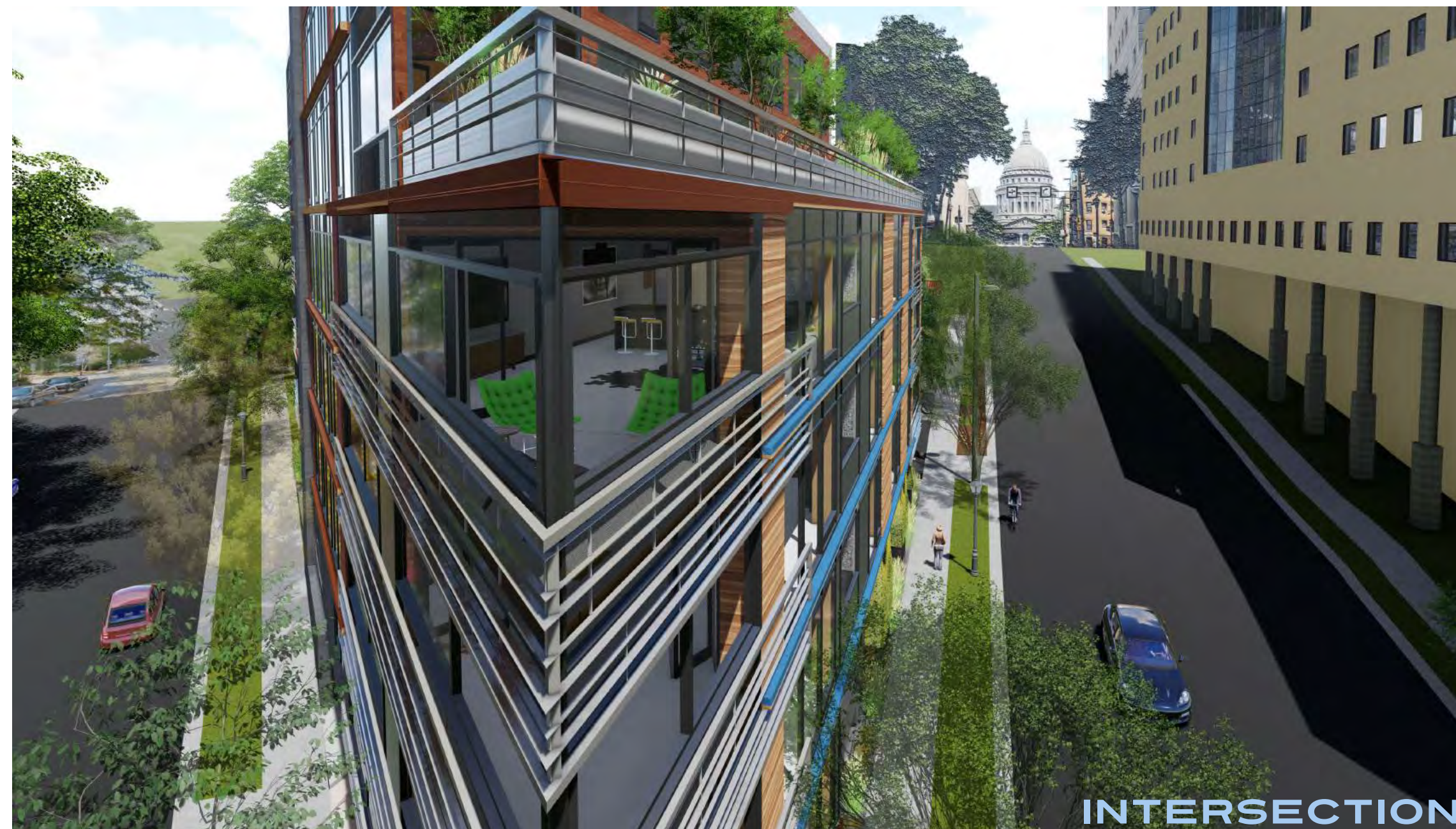

INTERSECTION

UDC INFORMATIONAL

HENRY HAMILTON PARTNERS
101 KING STREET
MADISON, WI 53703

DATE
07.18.18

THE BARRACUDA
222 S. HAMILTON
MADISON, WI 53703

A5.07

RENDERINGS



ALLEY ELEVATION



HENRY STREETSCAPE



HAMILTON STREETSCAPE

UDC INFORMATIONAL

HENRY HAMILTON PARTNERS
101 KING STREET
MADISON, WI 53703

DATE

07.18.18

THE BARRACUDA
222 S. HAMILTON
MADISON, WI 53703

A5.08

RENDERINGS



AERIAL VIEW TO LAKE MONONA



5TH TERRACE



5TH TERRACE

DATE	DESCRIPTION

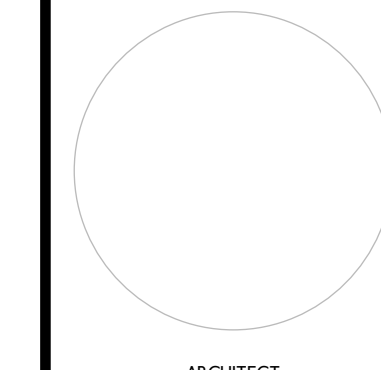

ARCHITECT



STRUCTURAL ENGINEER

UDC INFORMATIONAL

HENRY HAMILTON PARTNERS 101 KING STREET MADISON, WI 53703		DATE 07.18.18
THE BARRACUDA 22 S. HAMILTON MADISON, WI 53703		A5.09
RENDERINGS		



INTERIOR RENDERINGS



DRAWING NOTES

CODE NOTES

DATE	DESCRIPTION

UDC INFORMATIONAL

HENRY HAMILTON PARTNERS 101 KING STREET MADISON, WI 53703		DATE 07.18.18
THE BARRACUDA 22 S. HAMILTON MADISON, WI 53703		A5.10
RENDERINGS		



AA

AB

AC

AD

AE

AF

AG



5:00 AM



6:00 AM



8:00 AM



10:00 AM



NOON



2:00 PM



5:00 PM

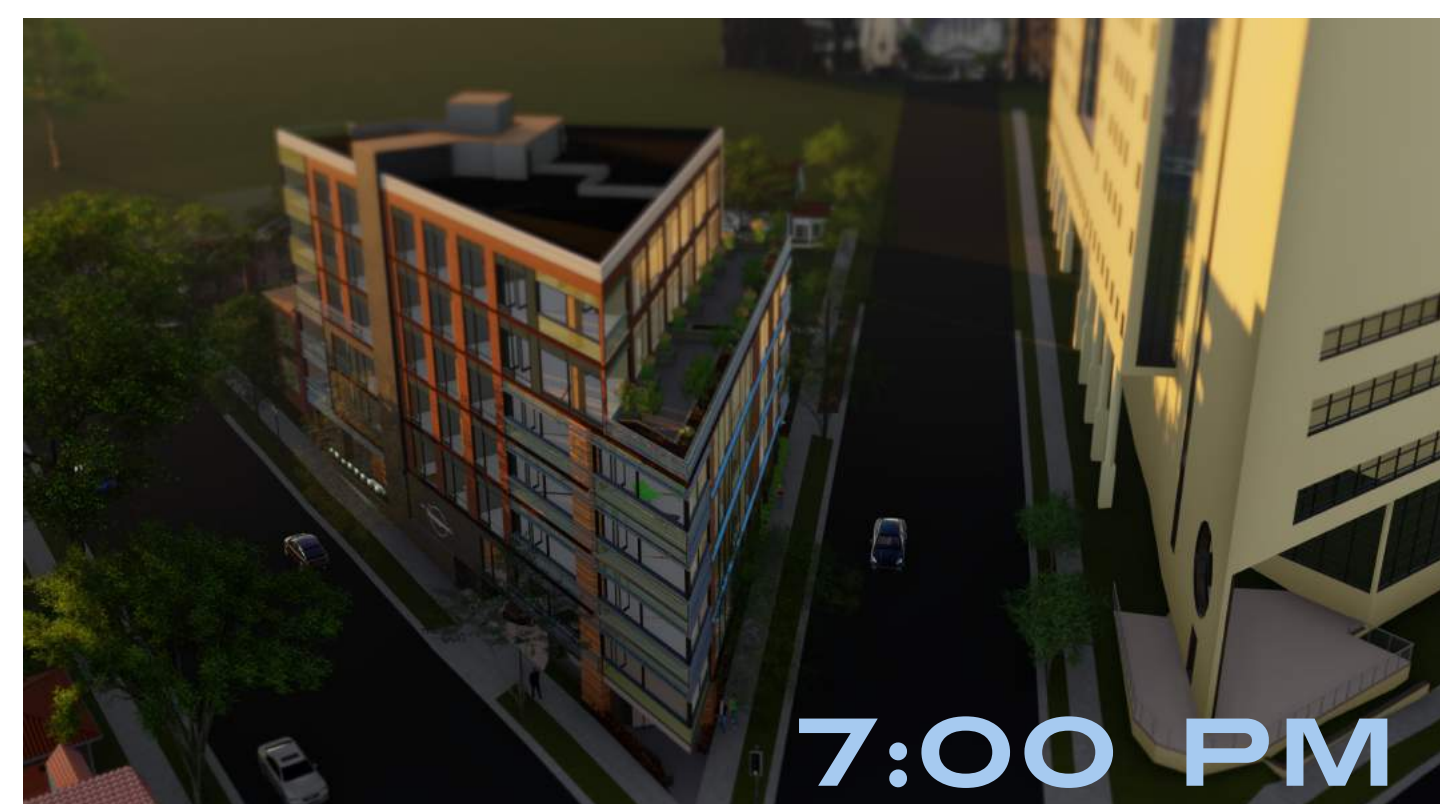

7:00 PM



9:00 PM

UDC INFORMATIONAL

HENRY HAMILTON PARTNERS
101 KING STREET
MADISON, WI 53703

DATE
07.18.18

THE BARRACUDA
222 S. HAMILTON
MADISON, WI 53703

A5.10

SHADOW STUDIES

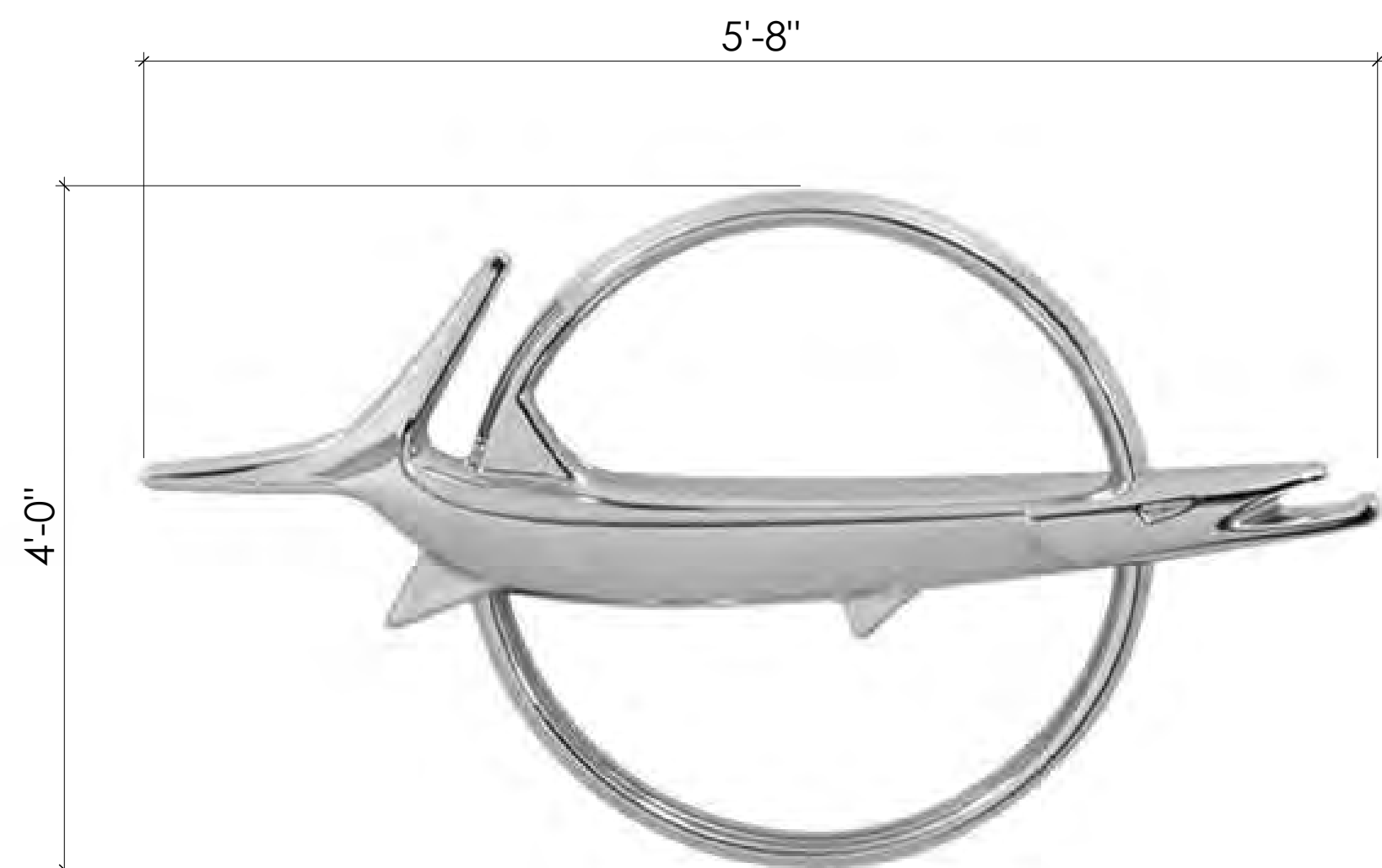

8" 222 SOUTH HENRY ST.

1 BUILDING LOGO

LOCATION: EXTERIOR WALL MOUNTED (Henry Street)
MATERIAL: ALUMINUM
ILLUMINATION: LED BACKLIT

2 BUILDING ADDRESS

LOCATION: EXTERIOR WALL MOUNTED
MATERIAL: ALUMINUM
ILLUMINATION: LED BACKLIT
FONT: TURNPIKE

8" SPHYRAENIDAE

3 COMMERCIAL SIGNAGE

LOCATION: EXTERIOR WALL MOUNTED
MATERIAL: ALUMINUM
ILLUMINATION: LED BACKLIT
FONT: TURNPIKE

DATE	DESCRIPTION

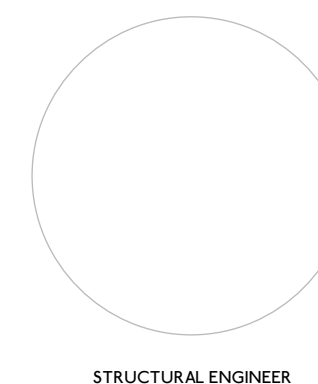
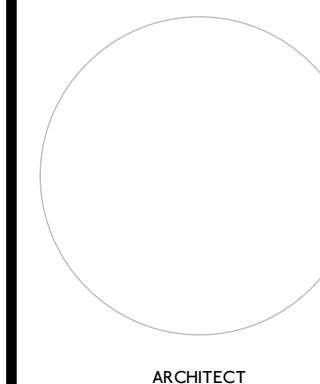

UDC INFORMATIONAL

HENRY HAMILTON PARTNERS
10 KING STREET
MADISON, WI 53703

DATE
07.18.18

THE BARRACUDA
222 S. HAMILTON
MADISON, WI 53703

A8.01

SIGNAGE