

**APPLICATION FOR  
URBAN DESIGN COMMISSION  
REVIEW AND APPROVAL**

**AGENDA ITEM #** \_\_\_\_\_  
**Project #** \_\_\_\_\_

DATE SUBMITTED: <u>12/28/07</u>	<b>Action Requested</b>
UDC MEETING DATE: <u>1/09/2008</u>	<input type="checkbox"/> Informational Presentation
	<input type="checkbox"/> Initial Approval and/or Recommendation
	<input checked="" type="checkbox"/> Final Approval and/or Recommendation

PROJECT ADDRESS: 3801 East Washington Avenue

ALDERMANIC DISTRICT: #17 Mr. Joe Clausius

OWNER/DEVELOPER (Partners and/or Principals) <u>Hy-Vee, Inc.</u>	ARCHITECT/DESIGNER/OR AGENT: <u>Henry Gempeler, Foley &amp; Lardner, LLP</u>
<u>5820 Westown Parkway</u>	<u>150 East Gilman Street</u>
<u>West Des Moines, IA 50266</u>	<u>Madison, WI 53703-1481</u>

CONTACT PERSON: Pete Hosch  
Address: 5820 Westown Parkway  
West Des Moines, IA 50266  
Phone: 515-327-2147  
Fax: 515-267-2967  
E-mail address: phosch@hy-vee.com

**TYPE OF PROJECT:**  
(See Section A for:)

- Planned Unit Development (PUD)
  - General Development Plan (GDP)
  - Specific Implementation Plan (SIP)
- Planned Community Development (PCD)
  - General Development Plan (GDP)
  - Specific Implementation Plan (SIP)
- Planned Residential Development (PRD)
- New Construction or Exterior Remodeling in an Urban Design District \* (A public hearing is required as well as a fee)
- School, Public Building or Space (Fee may be required)
- New Construction or Addition to or Remodeling of a Retail, Hotel or Motel Building Exceeding 40,000 Sq. Ft.
- Planned Commercial Site

(See Section B for:)

- New Construction or Exterior Remodeling in C4 District (Fee required)

(See Section C for:)

- R.P.S.M. Parking Variance (Fee required)

(See Section D for:)

- Comprehensive Design Review\* (Fee required)
- Street Graphics Variance\* (Fee required)
- Other \_\_\_\_\_

\*Public Hearing Required (Submission Deadline 3 Weeks in Advance of Meeting Date)

Where fees are required (as noted above) they apply with the first submittal for either initial or final approval of a project.



December 28, 2007

Urban Design Commission  
Attn: Mr. Al Martin  
Department of Planning & Development  
215 Martin Luther King Jr. Blvd., Suite LL 100  
Madison, WI 53701-2985

Re: Urban Design Commission Final Approval  
3801 E. Washington Kmart Redevelopment Project

Dear Urban Design Commission:

Hy-Vee, Inc. ("Hy-Vee") is submitting this letter of intent along with our Urban Design Commission Review and Approval Application for 'New Construction or Exterior Remodeling in an Urban Design District' and 'New Construction or Addition to or Remodeling of a Retail, Hotel, or Motel Building Exceeding 40,000 Sq. Ft.' Our goal is to obtain the necessary approvals for redevelopment of the former Kmart site located at 3801 East Washington Avenue.

We have presented our plans to the City's Development Assistance Team and have had subsequent meetings with representatives from Planning, Traffic, Urban Design, and Zoning. We met with District 17 Alder, Mr. Joe Clausius, and he has voiced his support of our project. We have presented at the Mayfair Park Neighborhood Association's quarterly meeting on October 16, 2007, and received their unanimous vote of approval for the project. We presented at the Hawthorn Neighborhood Association's monthly meeting on November 19, 2007, and also received a unanimous vote of approval for the project.

We have revised our plans based upon comments received at the November 7, 2007, Urban Design Commission Informational Presentation and the December 19, 2007, Urban Design Commission meeting where we received Initial Approval. The significant changes from the last meeting include:

- Wrapping the brick and EFIS materials around to the south corner of the building
- The Sentry Gingko was replaced with Washington Hawthorn, the Washington Hawthorn shown on the last plan was replaced with Apple Serviceberry, and the English Oak was replaced with Turkish Filburt.
- Quaking Aspen were added along the property line behind the building.
- Existing trees along the rear property line are shown on the plan.
- The orientation of the parking for the Hy-Vee Wine & Spirits and Tenant Space was reconfigured to improve circulation for the exiting drive-up window and grocery pick-up customers.
- Detailed plans added to the submittal for the front sidewalk space to highlight the allowable pedestrian movements.

- Colored concrete band and bollards added to the island at the edge of the canopy to distinguish pedestrian space and provide continuity across the front of the store.
- Colored concrete cross walk areas to distinguish pedestrian zones were added and enlarged to tie the pedestrian parkways to the front of the store.
- The photometric plan was updated to match the site plan changes and cut sheets of all the exterior lighting added to the submittal package.

We are seeking Final Approval at your January 9, 2008, meeting. As required prior to any formal action by Urban Design Commission, we have submitted an application for Plan Commission consideration. Planning Commission received that application along with the necessary fees and supporting documentation and we are part of the January 14, 2008, meeting.

**Project Name:** Former Kmart Redevelopment

**Address:** 3801 East Washington Avenue, Madison, WI 53704

**Alder Person:** Mr. Joe Clausius – District 17

**Development Team:**

Property Purchaser: Architects Inc. Willrich, AIA Moines, IA 50266	Hy-Vee, Inc., Real Estate Dept. Contact: Pete Hosch 5820 Westown Parkway Street, Suite 200 West Des Moines, IA 50266 515-327-2147 <a href="mailto:phosch@hy-vee.com">phosch@hy-vee.com</a>	Architect: SVPA Contact: Dan 1466 28 <sup>th</sup> West Des 515-327-5990
Site Planning: Construction Street IA 50313	Hy-Vee, Inc., Engineering Dept. Contact: Bree H. Cooper, P.E. 515-267-2947 <a href="mailto:bcooper@hy-vee.com">bcooper@hy-vee.com</a>	Contractor: Hy-Vee Weitz 5605 NE 22 <sup>nd</sup> Des Moines, 515-645-2300

Landscape Architect: To Be Determined

**Existing Conditions:**

The former Kmart facility is a 104,000 square foot building, 84,000 square feet of which is vacant and essentially has been since Kmart closed in April of 2003. Big Lots currently occupies the remaining 20,000 square feet, but has chose to leave the space in January of 2008.

The building is in sound structural condition. The exterior of the building features few windows and is constructed mostly masonry block walls that have been painted. A large EFIS signage area, a painted canopy, and steel appendages are the primary view to the public.

The parking lot is expansive and uninterrupted. It was once striped for over 780 stalls and is almost completely void of landscaping.

Hy-Vee also has the 0.5981-acre adjoining parcel located at 3809 East Washington Avenue, which is shown in green on the development plan, under contract for purchase. Credit Union Express currently has a long-term land lease on this property. The two parcels shown in yellow are not a part of the Hy-Vee purchase.

### **Project Overview:**

Hy-Vee would redevelop the existing 104,000 square foot building and approximately 8.85 acres of the 11.15-acre parcel. The plans would utilize the existing building structure while incorporating significant architectural interest. A large portion of the front façade will be removed to allow for dramatic building projection and multiple expanses of glass. The reconstruction of the façade gives us the structural flexibility to change the building profile height numerous times. Color and texture are varied by incorporating brick, glass, and EFIS.

The Mendota Street façade will be refaced with brick and EFIS to match the color and texture of the front façade. Brick pilasters are added as vertical elements to break up the span. A tenant space is proposed near the south (rear) of the building with the customer access fronting Mendota Street.

The brick, glass and EFIS present on the front elevation will wrap around to the east elevation and will incorporate a fenced outdoor dining area for the patio feature on the corner of the building. The remainder of the east and all of the south elevations will be painted to match the color scheme of the upgraded building materials

The redevelopment would incorporate a serpentine drive aisle through the parking lot to connect Mendota Street to the East Washington Avenue entrance. The parking lot design elements will comply with City code relative to layout, lighting, and landscaping requirements. Underground infiltration systems will be incorporated into the site near each of the pedestrian parkways described below.

The plan includes two landscaped pedestrian parkways. The first directly connects the East Washington Avenue sidewalk to a large patio feature outside of the store's casual dining area. It also incorporates a plaza feature at the northeast end of the pedestrian parkway. The second pedestrian parkway will guide customers to a point on the sidewalk in front of the facility that allows them to choose a route to the secondary food store entrance or a route to the Hy-Vee Wine & Spirits and tenant space entrances. Pedestrian will access the facility from Mendota Street via a pedestrian pathway starting at the main Mendota Street entrance and connecting to the front of the building.

Site landscaping will utilize a variety of plant species, many of which are native to the area and therefore remain appealing through seasonal change. The development plan identifies many of the proposed trees and shrubs. The landscape buffering that exists between the building and Mendota Street will be enhanced to aid in the visual screening from the adjacent residential properties.

**Building Uses and Area:**

The redevelopment would consist of an 85,556-square-foot Hy-Vee food store, a 5,114 square-foot attached Hy-Vee Wine & Spirits facility, and an additional 12,077 square feet of lease space. The lease space would likely be made up of one larger tenant with its entrance fronting East Washington and a smaller tenant with its entrance fronting Mendota Street. The 1,253-square-foot reduction in building footprint is the result of modifications to the existing structure to improve delivery service and to enhance the architecture of the building.

1. Total gross square footage: 102,747 sq. ft.
2. Hy-Vee Food Store: 85,556 sq. ft. (some detail as follows)
  - a. Pharmacy: 830 sq. ft.
  - b. Bank: 520 sq. ft.
  - c. Floral: 380 sq. ft.
  - d. Starbucks: 604 sq. ft.
  - e. Casual Dining: 2,676 sq. ft.
  - f. Club Room: 1,211 sq. ft.
  - g. Offices: 1,437 sq. ft.
  - h. Back Room: 9,053 sq. ft.
  - i. Digital Photo
  - j. Bakery
  - k. Health Market
  - l. Grocery / Dairy / Produce / General Merchandise
  - m. Food Service
  - n. Service Meats
3. Hy-Vee Wine & Spirits: 5,114 sq. ft.
4. Tenant Space: 12,077 sq. ft.

**Operation and Site Detail:**

- Parking:
  - + Hy-Vee Food Store and Hy-Vee Wine & Spirits: 359 parking stalls (4.0 / 1000 SF)
  - + Leased space: 40 parking stalls (3.3 / 1000 SF)
- Deliveries:
  - + The facility has two service dock doors and a vendor delivery door on the east elevation.
  - + The south elevation has a screened scissors lift to service both the tenant space and Hy-Vee.
- Hours:
  - + The Hy-Vee Food Store will be a 24-hour facility.
  - + The Hy-Vee Wine & Spirits store will have operational hours in accordance with state and local laws.
  - + It would not be likely for the leased space to operate outside the hours of 8:00am and 10:00pm.
- Maintenance:
  - + Two trash compactors are located along the south elevation approximately 270' and 420' from Mendota Street.
  - + Professional snow removal will be arranged for the entire site by the Store Director and maintained in accordance with City standards.

Employment Estimate: Hy-Vee would expect to employ between 350 and 400 people and the leased space would account for additional employment beyond that.

Construction Schedule: Pending conditional use and building permit approval we anticipate a Fall 2008 construction start with a Fall 2009 grand opening.

Hy-Vee truly appreciates your review of our project and please don't hesitate to call should any questions arise.

Sincerely,

HY-VEE, INC.

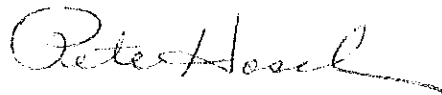
A handwritten signature in black ink that reads "Pete Hosch". The signature is written in a cursive style with a long horizontal flourish at the end.

Pete Hosch  
Assistant Vice President, Real Estate

Enclosures:

1. application
2. location map
3. proposed site plan rendering
4. building elevations
5. site development plan
6. photometric plan
7. building footprint plan
8. roof plan
9. signage package
10. building accent light cut sheet
11. parking lot lights cut sheets

cc: Dennis Ausenus  
Ken Waller  
Steve Meyer

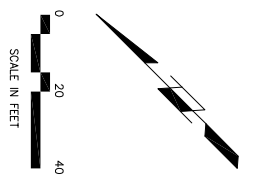
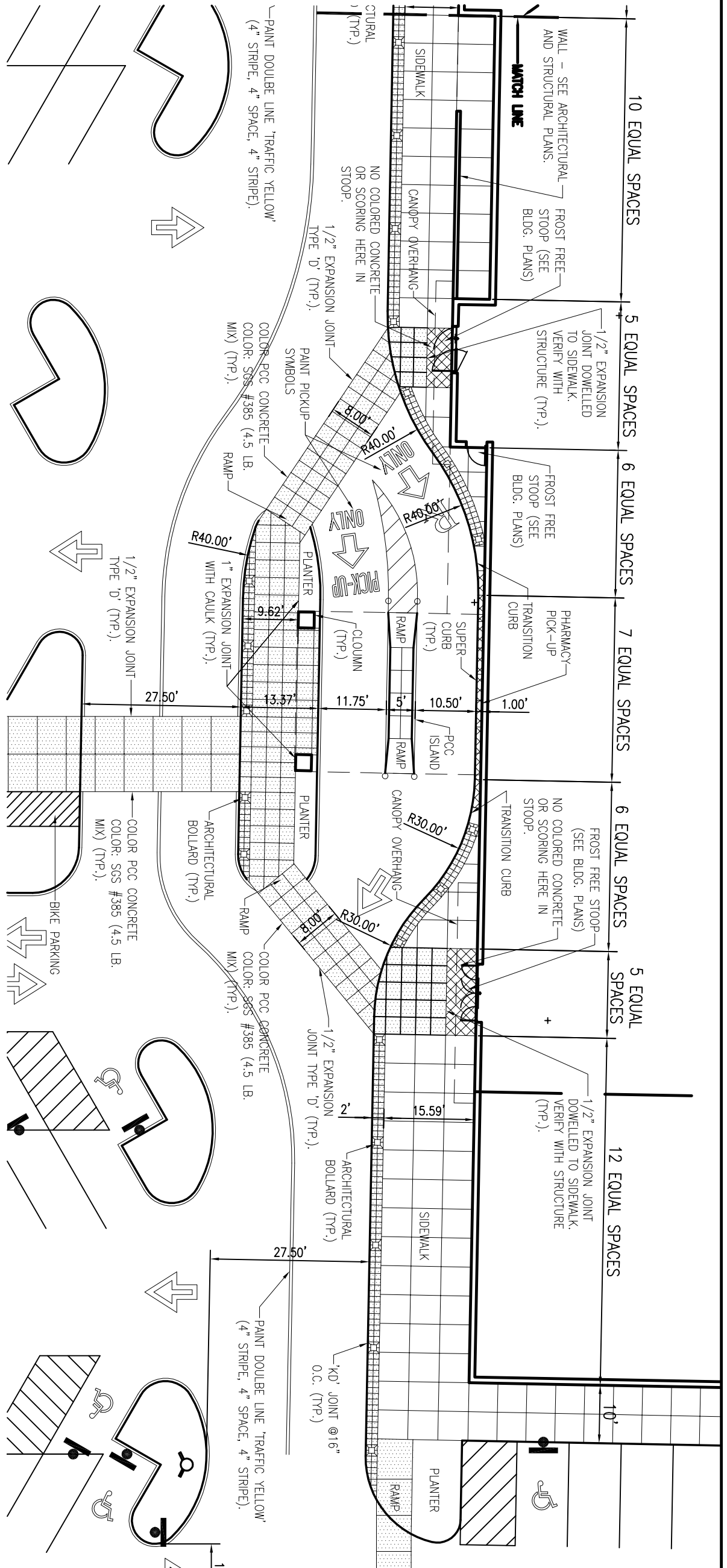

<b>FRONT ENTRY DETAIL</b>	TRENORTH PLANORTH	LOCATION: <b>MADISON, WISCONSIN EAST WASHINGTON</b> HY-VEE, INC. 5820 WESTOWN PARKWAY WEST DES MOINES, IOWA 50266 TELEPHONE: (515) 267-2800 FAX: (515) 267-2935 EMPLOYEE OWNED			
<b>D4.0</b>	DATE: 12/27/2007 BY: JAH SCALE: 1/8" = 1'-0"	REVISION DATE BY			

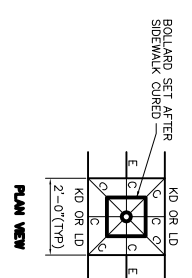
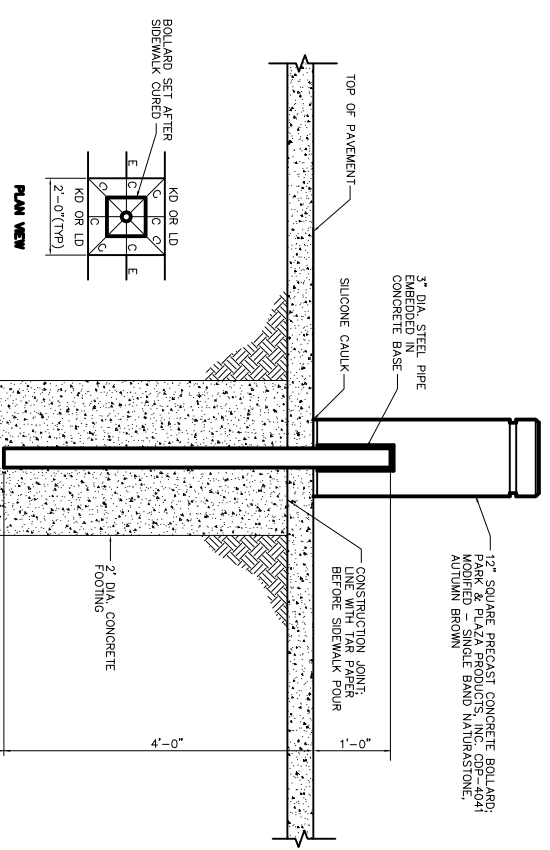
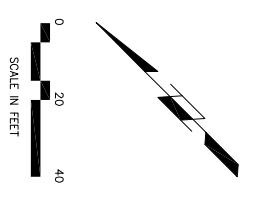
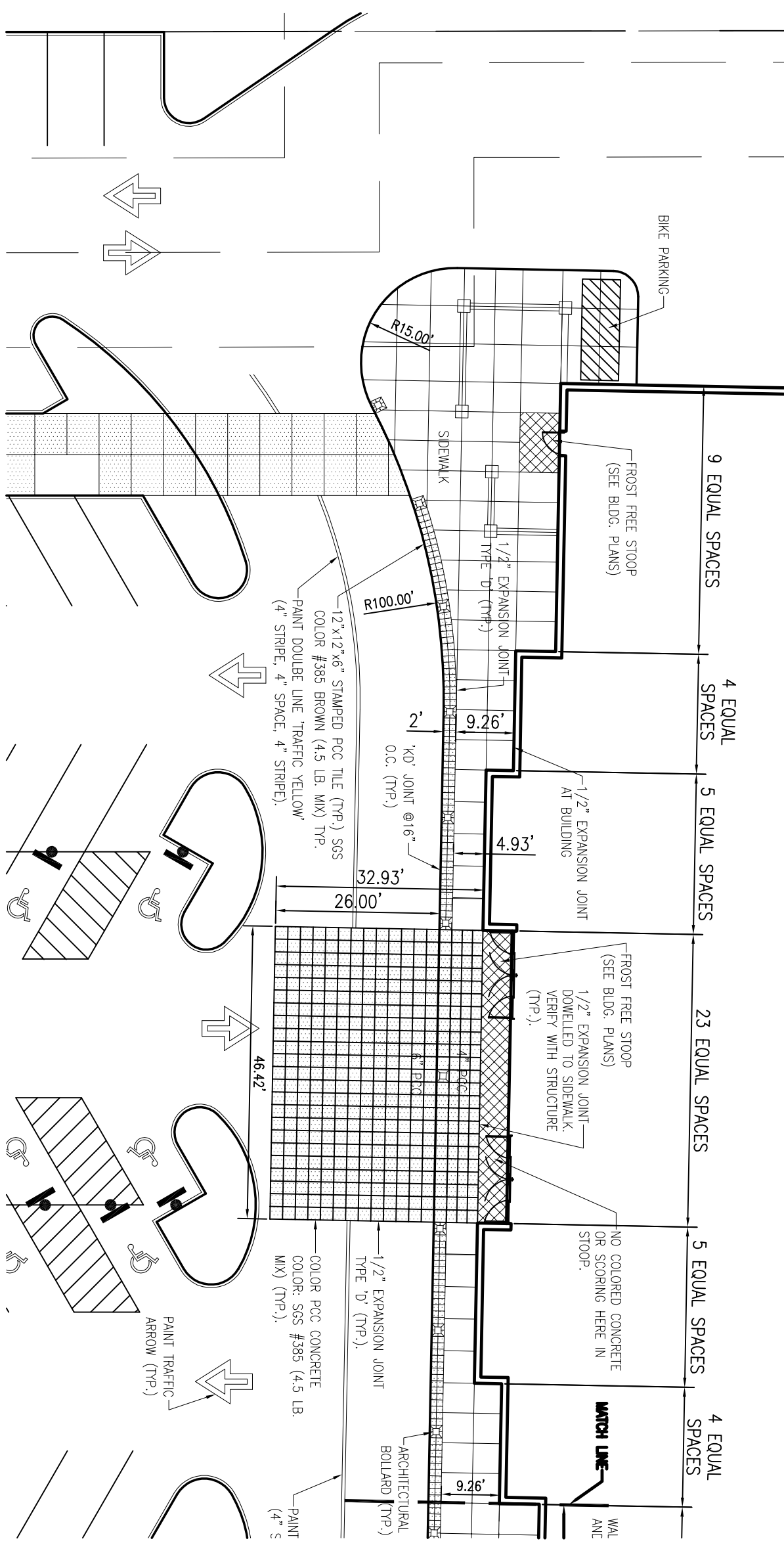

1 ARCHITECTURAL BOLLARD

REVISION

DATE

BY

LOCATION:  
**MADISON, WISCONSIN**  
**EAST WASHINGTON**

HY-VEE, INC.  
 5820 WESTOWN PARKWAY  
 WEST DES MOINES, IOWA 50266  
 TELEPHONE: (515) 267-2800  
 FAX: (515) 267-2935

**HyVee**  
 EMPLOYEE OWNED

TRUE NORTH PLANNORTH

FRONT ENTRY DETAIL

D3.0

DATE	12/27/2007
BY	BAH
SCALE	AS SHOWN
SHEET	



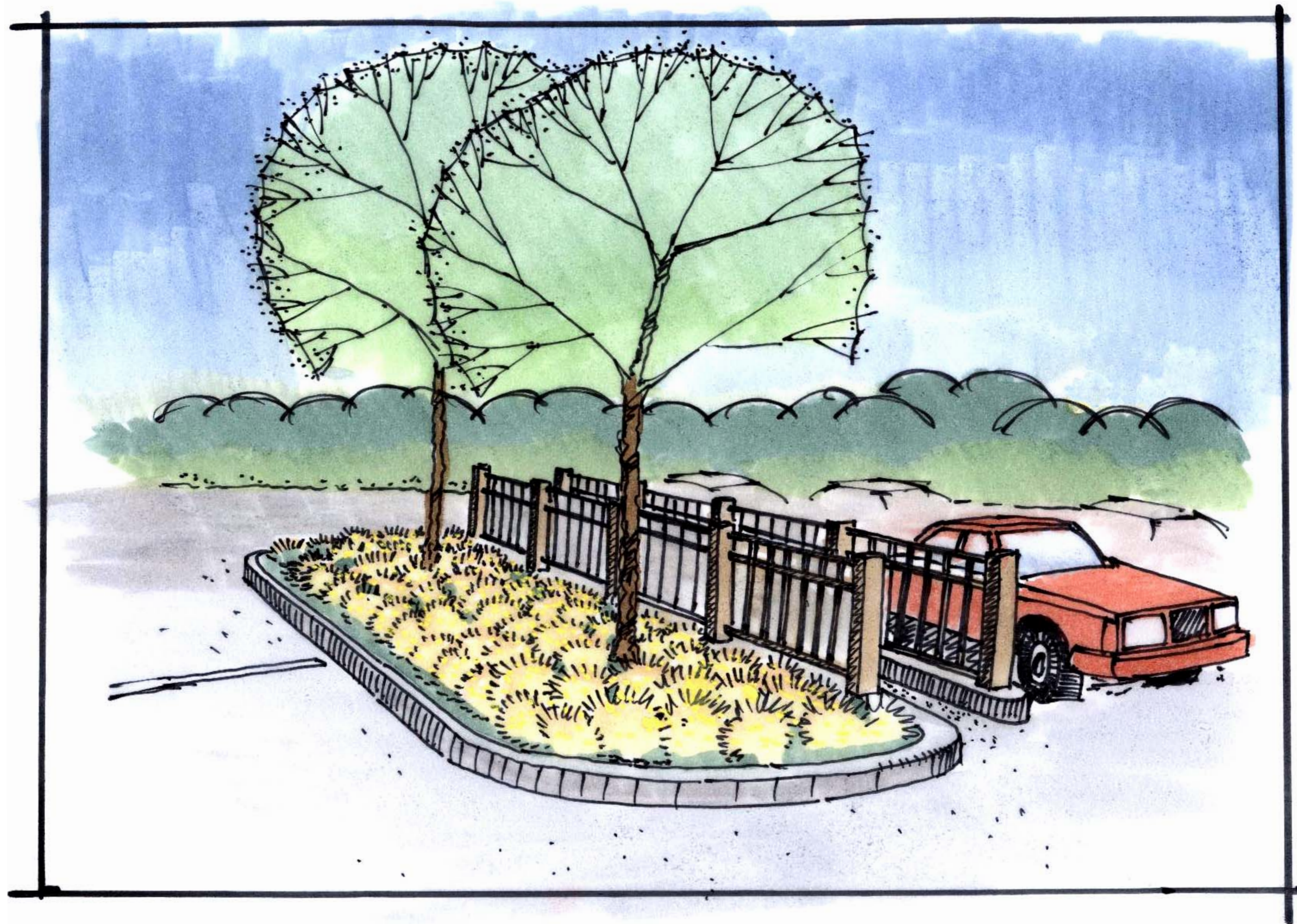

Hy-Vee Prototype Cart Corral



# YRW-2-800 Series



## Design Features

**Housing:** Four heavy gauge .188 wall extruded aluminum sections interlock to form the cylinder housing. Two sections are internally welded to lower cast lens frame and two sections are bolted to mounting bracket and welded to upper lens frame.

**Lens Assembly:** Clear heat tempered glass lens are sealed in regressed cast aluminum frames. The lower frame is welded to two extruded sections which easily slides down for relamping and ballast maintenance by releasing a single set screw. A safety chain secures the frame in place.

**Optical System:** Spun aluminum reflectors with specular finish are attached to cast frame. Reflectors provide a smooth symmetrical distribution.

**Mounting Bracket:** Extruded aluminum arm is internally welded to cast back plate. Arm is bolted to housing with two 3/8" bolts. Steel zinc plated bracket mounts to wall surface and is attached to the cast plate with two stainless steel fasteners.

**Ballast/Lamp Assembly:** All ballast shall have a high power factor and be suitable for -20° F operation. The ballast module is easily removable for maintenance. The lamp socket shall be porcelain medium base pulse-rated and securely mounted to housing.

**Finish:** Polyester powder coating on all metal parts. Color to be specified.

**Listing:** Luminaire is ETL listed for wet locations.

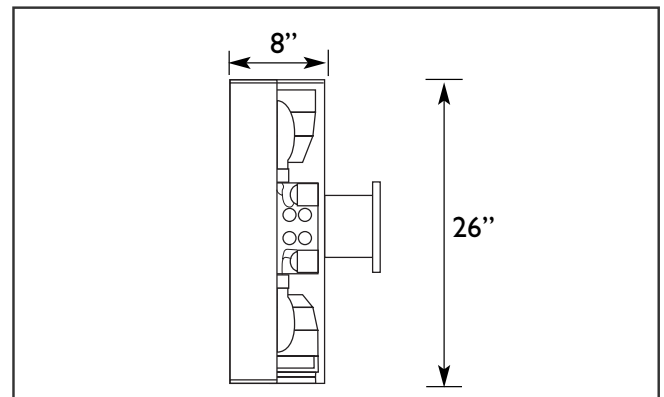
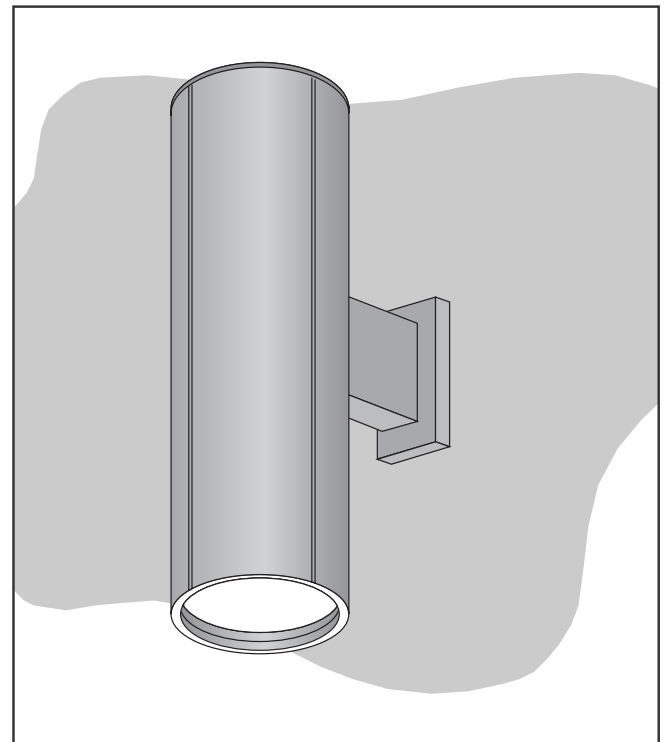

## Specification Guide

Series	Wattage/Lamp	Volts	Options	Finish
YRW-2	100w/MV = 810V	120	IF = Single Fuse	BZ = Bronze
	70w/HPS = 807S	208	2F = Double Fuse	BK = Black
	100w/HPS = 810S	240	PH = Button Cell	WH = White
	70w/MH = 807H	277	FL = Fresnel Lens	SL = Silver
	100w/MH = 810H	480		CC = Custom Color
	175W/MH=817H			

**Example:** 100 Watt, Metal Halide, 120 Volts, Single Fuse, Bronze  
**YRW-2-810H-120/IF/BZ**

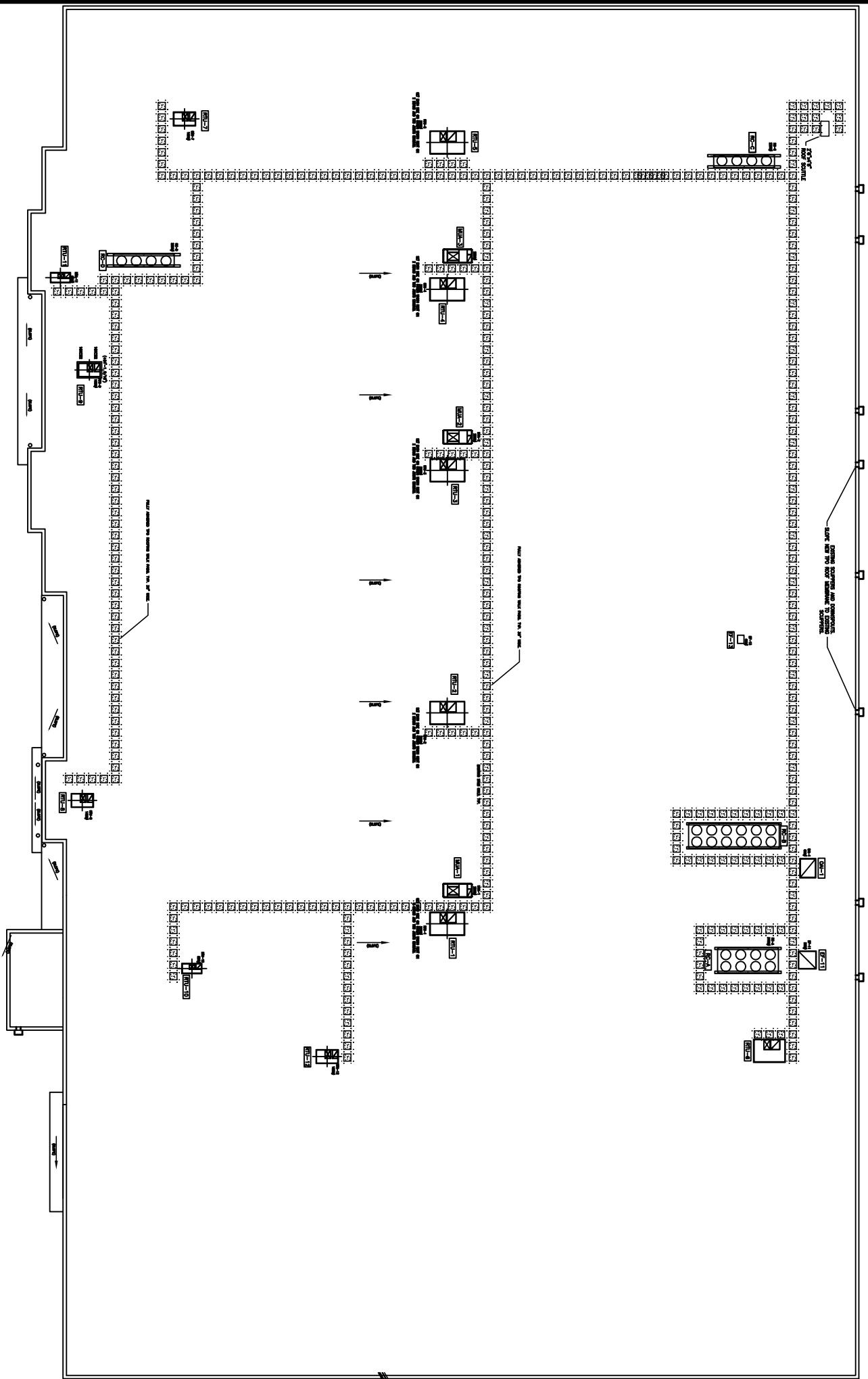

**ROOF PLAN**  
SCALE: 1/16" = 1'-0"

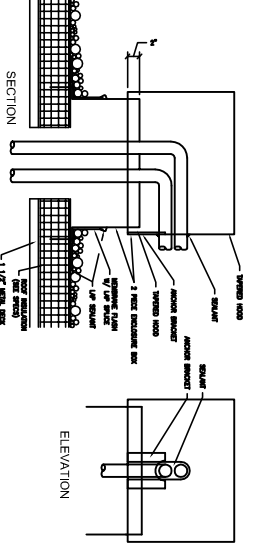

**MULTIPLE PENETRATIONS  
CLOSURE BOX DETAILS**  
SCALE: 1" = 1'-0"

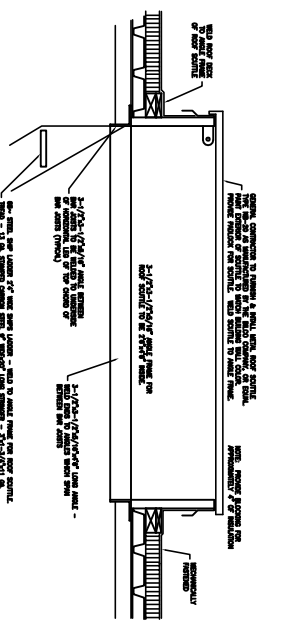

**ROOF SCUTTLE DETAIL**  
SCALE: 1" = 1'-0"

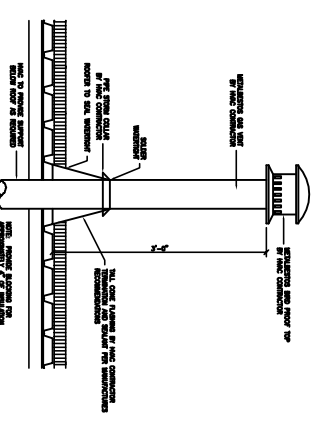

**GAS VENT DETAIL**  
SCALE: 1" = 1'-0"

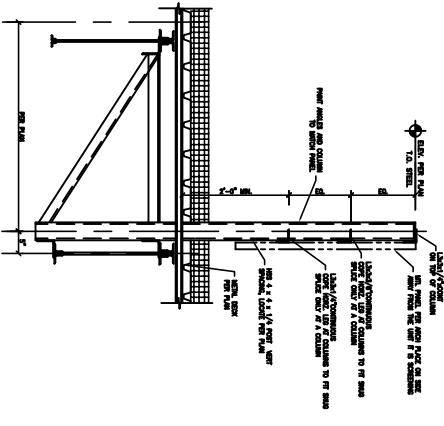

**ROOF SCREEN  
PARALLEL TO JOIST.**  
SCALE: 3/4" = 1'-0"



**DOWNSPOUT  
DETAIL**  
SCALE: 1-1/2" = 1'-0"

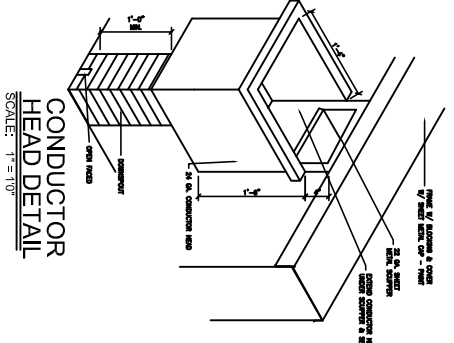

**CONDUCTOR  
HEAD DETAIL**  
SCALE: 1" = 1'-0"

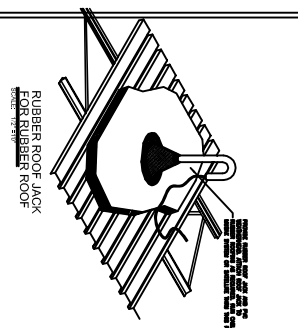

**RUBBER ROOF JACK  
FOR RUBBER ROOF**

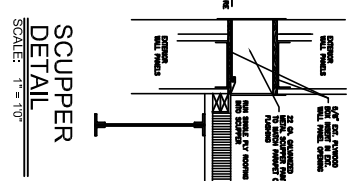

**SCUPPER  
DETAIL**  
SCALE: 1" = 1'-0"

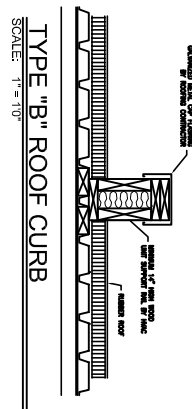

**TYPE "B" ROOF CURB**  
SCALE: 1" = 1'-0"

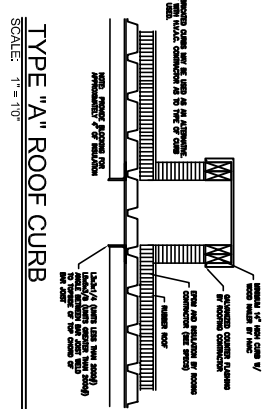

**TYPE "A" ROOF CURB**  
SCALE: 1" = 1'-0"

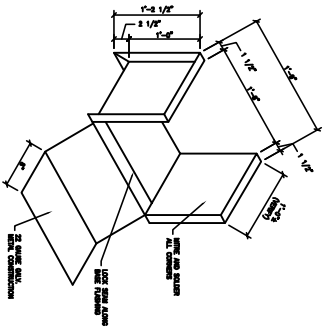

**SCUPPER INSERT  
ISOMETRIC VIEW**  
SCALE: 1" = 1'-0"

REVISION  
BY

**LOCATION:**  
**MADISON, WISCONSIN**

**HyVee**  
EMPLOYEE OWNED

HY-VEE, INC.  
5820 WESTOWN PARKWAY  
WEST DES MOINES, IOWA 50266  
TELEPHONE: (515) 267-2800  
FAX: (515) 267-2935

TRUE NORTH

PANORPH

**ROOF  
PLAN**

**A8.0**

DATE: 9/20/07  
BY: JST  
SET SHEET: MAD-01.AND07

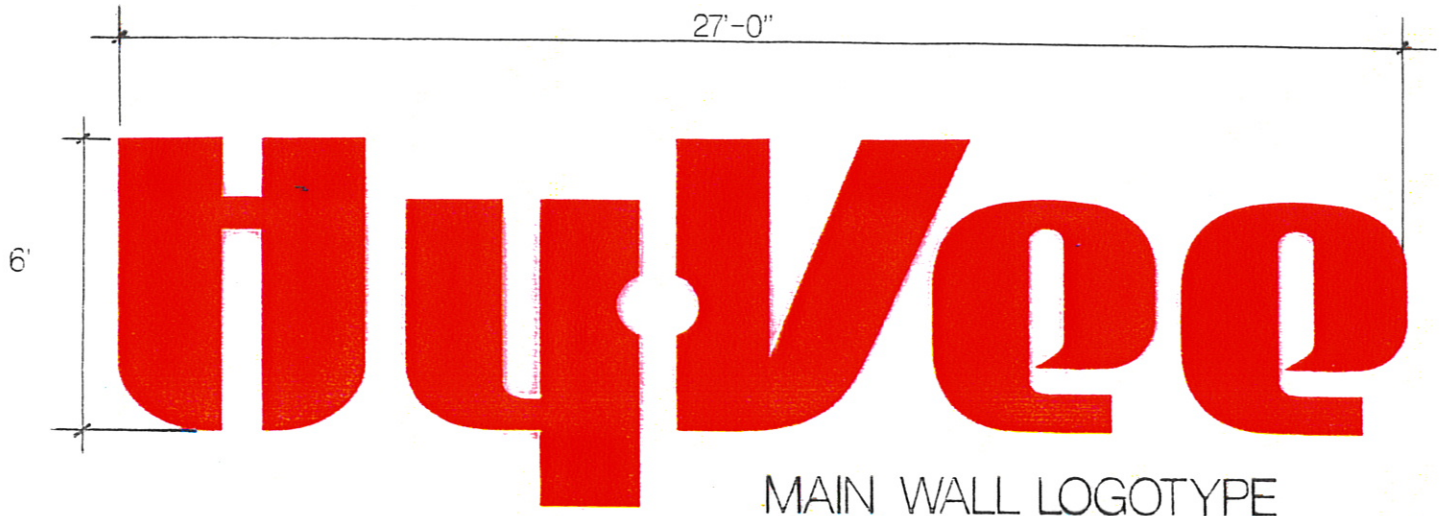

MAIN WALL LOGOTYPE

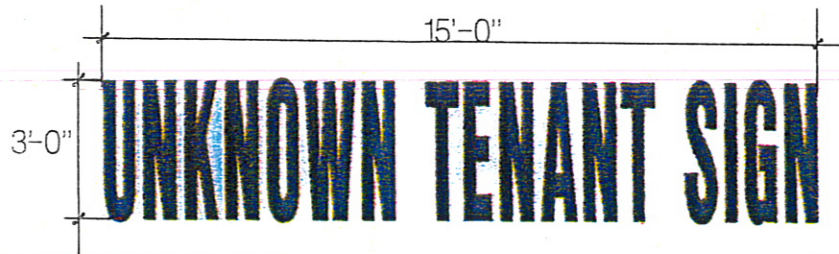

ALL ABOVE PLEX FACELIGHTED CHANNEL LETTERS

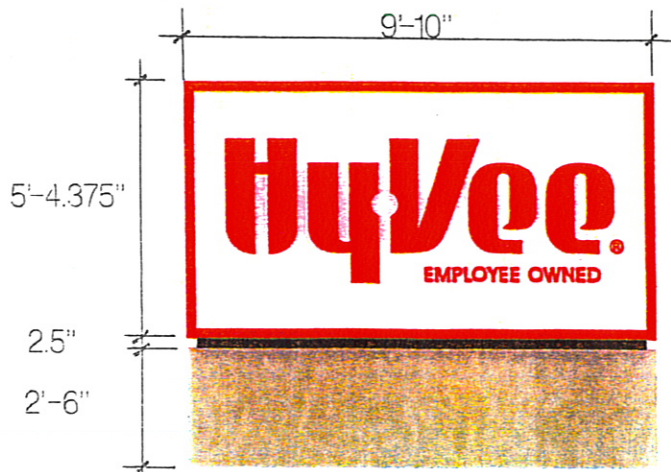

INTERIOR ILLUMINATED MONUMENT SIGN  
ON FABRICATED TEXTURED BASE  
(2) REQUIRED

HY-VEE (PERMIT SHEETS)  
MADISON, WIS  
G-27374  
11/1/2007 (SHEET 1 OF 2) *H.G.*

22'-10"  
18"  
**PHARMACY DRIVE-UP**

21'-4"  
18"  
**GROCERY DRIVE-UP**

6'-1"  
18"  
**FOOD**

12'-1"  
18"  
**PHARMACY**

12'  
2'  
**UNKNOWN BANK**  
(UNKNOWN NAME, UNKNOWN COLORS)

---

ALL ABOVE PLEX FACELIGHTED CHANNEL LETTERS

---

HY-VEE (PERMIT SHEETS)  
MADISON, WIS  
G-27374  
11/1/2007 (SHEET 2 OF 2) *de*



↓

Illuminated Horizontal Wall Signs		
PSIN #	CPU-C2A	CPU-C3A
PSIN #	6128	6129
A	6'-3 3/8"	4'-3 3/8"
B	3'-5 3/8"	2'-4 1/8"
C	9 1/4"	9 1/4"
VOLTS	120	120
AMPS	2.8	1.6

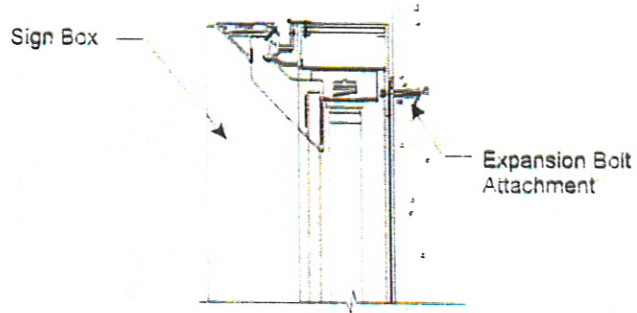

**Section / Mounting Detail**

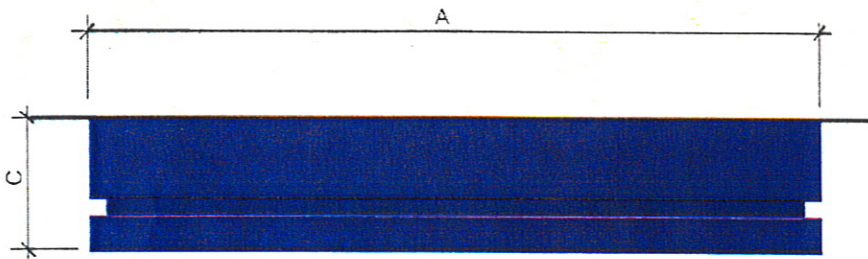

**CPU Illuminated Horizontal Wall Signs**

PSIN# CPU-C2A, CPU-C3A

Usage: Preferred format for primary wall identification shall be used on all CPU facility exteriors unless restricted by city or landlord.

Note: CPU signage must be obtained through the USPS Direct Vendor purchasing agreement.