

Algae Removal Project Update: 5-11-2015

#14
38272

Located on an isthmus, Madison is particularly lucky to have a number of great public beach facilities. Unfortunately, the enjoyment of these beaches has been periodically marred by the arrival of algal blooms that occur during the summer months. Additionally, the location of some of the beach areas compound the algae problem as prevailing winds from the west gather algae into thick mats along the eastern shore of both lake Monona and Mendota. Once gathered near the waterline, the algae become particularly difficult to remove due to its semi-liquid nature.

The scale of the algae problem and the difficulty with which the algal scums are removed is demonstrated in this photo from BB Clarke Beach.

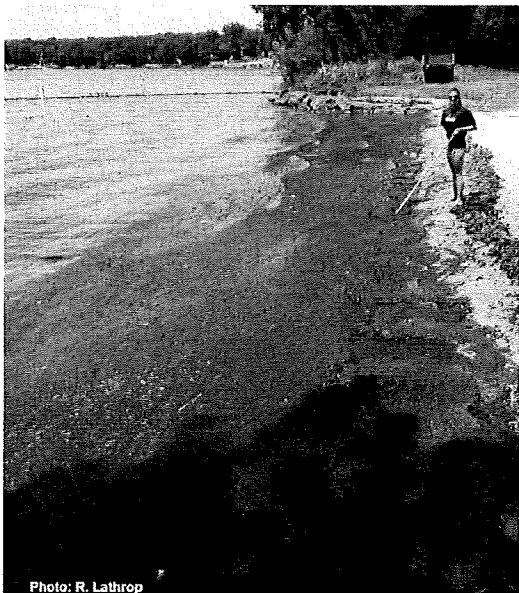

Photo: R. Lathrop
A lifeguard at BB Clark Beach uses a rake to remove algal scum from Lake Mendota in July, 2014

A Solution to Algae Removal

Over the past weeks, the Madison College based design team has conducted extensive research into the design of filtration systems, pumps and the nature of the algae to be removed from the beaches. From our research we have formulated a design which we feel will be effective at the removal of algal scums from Madison's public beaches.

Our design will be of suitable size to clean a portion of a public beach and swimming area. We hope to operate this system a number of times over the summer to validate and fine tune our design as well as gather data on the algae removed from the beaches. .

Current Design

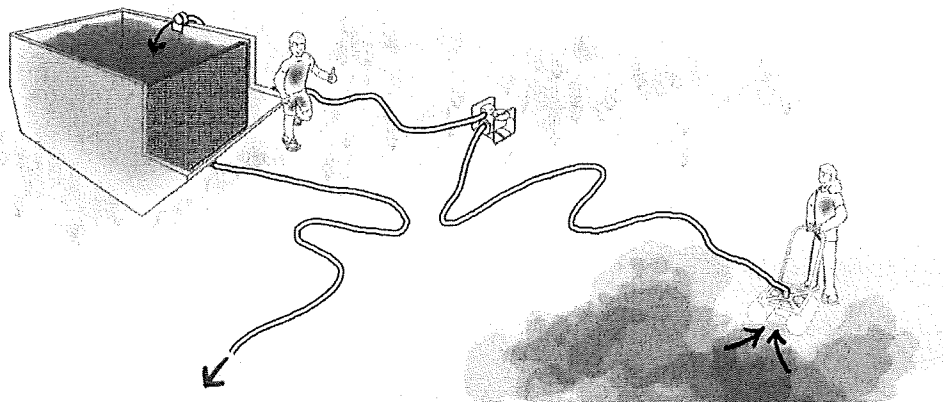

Our current design consists of a modified 10-yard refuse container, a gasoline powered heavy duty water pump and a floating intake of our own design.



Algae Removal Project Update: 5-11-2015

The Floating Intake

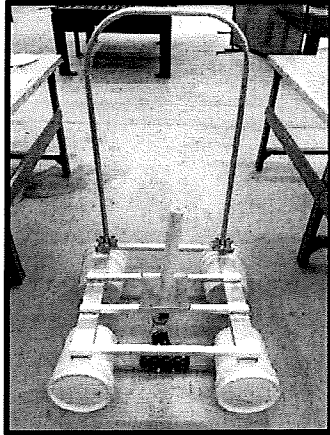

Keeping the water inlet at the proper depth is crucial to the operation of the system. The floating intake nozzle maintains the water inlet at the proper depth in the water to prevent air intake and prevent intake of sand and debris from the lake bed.

Water Pump

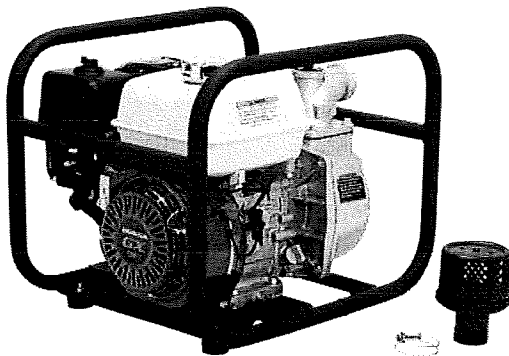

The water pump provides the suction to transport the algae/water from the intake nozzle to our filtration system.

The pump in our design is very commonly available, gasoline powered pump, known as a trash pump, capable of handling water with significant debris.

Algae Strainer

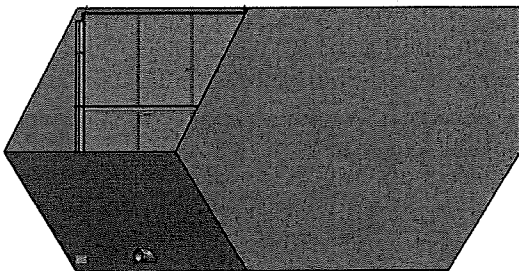



After the pump and intake remove the algae from the lake, it travels through a fire hose and arrives at the modified 10-yard refuse container. The container, essentially a dumpster, has been outfitted with a metal mesh screens secured to a steel frame. The water-algae mixture enters the dumpster, is strained by the mesh screens and the strained water flows from dumpsters through outlet pipe and back to the lake.





Water Filtration Device

Introduction to Engineering

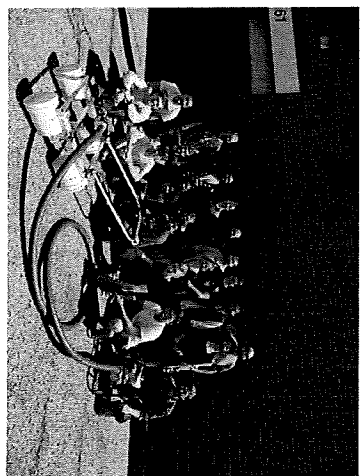

OS 93415

Our Team



Faculty Advisors: Jon Christian; Kristofer Dressler; Dr. Kenneth Waiz

Problem Assessment

- Our Goal:
 - Design a device that will rid the Madison Lakes of blue green algae.
 - Improve the swimming condition and appearance of the lakes.

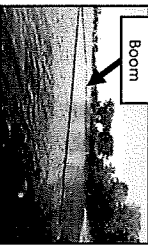

Boom



Current system is designed to act as a barrier and keep the algae out of the swimming area. Also known as the Boom.



Algae bloom at Warner Park beach



Method of cleaning - Raking

Our Partners

The Clean Lake Alliance:

The Clean Lakes Alliance and Richard Lathrop provided our team with the funding and a wealth of knowledge pertaining to the lakes and the nature of the algae to be removed.

The City of Madison

The City of Madison provided us with excellent support in form of materials for our filter unit as well as logistical support

A very sincere thank you to all of our partners that gave us their time and assistance with the water filtration project!

MADISON MADISON COLLEGE

System Configuration

CLEAN WATER

MADISON MADISON COLLEGE

Intake System

- The Inlet attachment floats
- Moved around water by one person using a handle attached to the device.
- Inlet is lightweight and easily steered with a 32" pivoting handle.
- Dimensions (L x W) 2'x3'
- Floats via x4 2 gallon buckets

CLEAN WATER

MADISON MADISON COLLEGE

Current Design



CLEAN WATER

MADISON MADISON COLLEGE



Water Filter Internal View

- Filter is mounted in Algae Collector
- Filter is easily pulled out via rope and slides along the pegs
- Algae collector is (L x W) 130" X 68"
- Requirements include ease of cleaning & removal

CLEAN WATER





Pump System



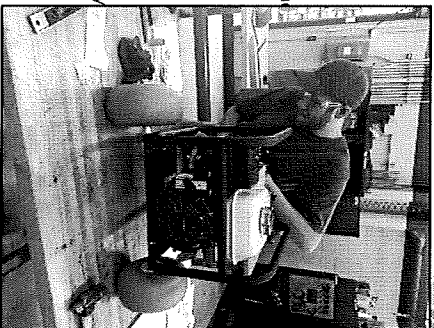

- Pump priced at \$470
- 63lbs
- 167 gallons per minute
- Inlet / Outlet 2" (will require reducer and coupling)
- Self Primed
- Run time of 2hrs
- Reducer, Wheel-axle kit, Bracket kit, Coupling, Inlet Hose will complete the pump system
- 100ft of hose was graciously donated by the Madison Fire Department







Moving Forward/Implementation



- With fabrication largely completed, the water filtration device will be ready for testing by May 18th, 2015
- Our team is largely flexible, testing and beach cleaning operations can be done at any time that may be preferred by the parks department.
- Staffing for the testing and first operations of the water filtration device will be largely handled by Madison College Students, but any personnel from the City of Madison or Parks Department are more than welcome to attend and assist.

Total Cost Estimates

Filtration Unit	\$850
Pump System	\$900
Intake System	\$400
Estimated Total Cost	\$2,150

Questions?

