

City of Madison
 Planning Division
 Madison Municipal Building, Suite 017
 215 Martin Luther King, Jr. Blvd.
 P.O. Box 2985
 Madison, WI 53701-2985
 (608) 266-4635



FOR OFFICE USE ONLY:

Paid _____ Receipt # _____

Date received _____

Received by _____

Aldermanic District _____

Zoning District _____

Urban Design District _____

Submittal reviewed by _____

Legistar # _____

Complete all sections of this application, including the desired meeting date and the action requested.

If you need an interpreter, translator, materials in alternate formats or other accommodations to access these forms, please call the phone number above immediately.

1. Project Information

Address: 5817 Halley Way

Title: Capitol View Apartments

2. Application Type (check all that apply) and Requested Date

UDC meeting date requested December 1st, 2021

- New development Alteration to an existing or previously-approved development
 Informational Initial approval Final approval

3. Project Type

- Project in an Urban Design District
 Project in the Downtown Core District (DC), Urban Mixed-Use District (UMX), or Mixed-Use Center District (MXC)
 Project in the Suburban Employment Center District (SEC), Campus Institutional District (CI), or Employment Campus District (EC)
 Planned Development (PD)
 General Development Plan (GDP)
 Specific Implementation Plan (SIP)
 Planned Multi-Use Site or Residential Building Complex

Signage

- Comprehensive Design Review (CDR)
 Signage Variance (i.e. modification of signage height, area, and setback)
 Signage Exception

Other

Please specify _____

4. Applicant, Agent, and Property Owner Information

Applicant name Scott Frank
Street address 719 Jupiter Dr
Telephone 608.663.6800

Company Oak Park Place
City/State/Zip Madison, WI 53718
Email sfrank@oakparkplace.com

Project contact person Bradley R Servin
Street address 5100 Eastpark Blvd, Suite 310
Telephone 608.254.6181

Company Architectural Design Consultants, Inc
City/State/Zip Madison, WI 53718
Email b.servin@adcidesign.com

Property owner (if not applicant) _____

Street address _____ **City/State/Zip** _____

Telephone _____ **Email** _____

5. Required Submittal Materials

- Application Form**
- Letter of Intent**
 - If the project is within an Urban Design District, a summary of how the development proposal addresses the district criteria is required
 - For signage applications, a summary of how the proposed signage is consistent with the applicable CDR or Signage Variance review criteria is required.
- Development Plans** (Refer to checklist on Page 4 for plan details)
- Filing fee**
- Electronic Submittal***
- Notification to the District Alder**
 - Please provide an email to the District Alder notifying them that you are filing this UDC application. Please send this as early in the process as possible and provide a copy of that email with the submitted application.

Each submittal must include fourteen (14) 11" x 17" **collated** paper copies. Landscape and Lighting plans (if required) must be **full-sized and legible**. Please refrain from using plastic covers or spiral binding.

Both the paper copies and electronic copies must be submitted prior to the application deadline before an application will be scheduled for a UDC meeting. Late materials will not be accepted. A completed application form is required for each UDC appearance.

For projects also requiring Plan Commission approval, applicants must also have submitted an accepted application for Plan Commission consideration prior to obtaining any formal action (initial or final approval) from the UDC. All plans must be legible when reduced.

**Electronic copies of all items submitted in hard copy are required. Individual PDF files of each item submitted should be compiled on a CD or flash drive, or submitted via email to udcapplications@cityofmadison.com. The email must include the project address, project name, and applicant name. Electronic submittals via file hosting services (such as Dropbox.com) are not allowed. Applicants who are unable to provide the materials electronically should contact the Planning Division at (608) 266-4635 for assistance.*

6. Applicant Declarations

1. Prior to submitting this application, the applicant is required to discuss the proposed project with Urban Design Commission staff. This application was discussed with Kevin Firchow & Chris Wells on 08/24/2021.
2. The applicant attests that all required materials are included in this submittal and understands that if any required information is not provided by the application deadline, the application will not be placed on an Urban Design Commission agenda for consideration.

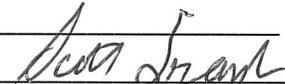
Name of applicant Scott Frank Relationship to property Owner
 Authorizing signature of property owner  Date 10/05/2021

7. Application Filing Fees

Fees are required to be paid with the first application for either initial or final approval of a project, unless the project is part of the combined application process involving the Urban Design Commission in conjunction with Plan Commission and/or Common Council consideration. Make checks payable to City Treasurer. Credit cards may be used for application fees of less than \$1,000.

Please consult the schedule below for the appropriate fee for your request:

- Urban Design Districts: \$350 (per §35.24(6) MGO).
- Minor Alteration in the Downtown Core District (DC) or Urban Mixed-Use District (UMX) : \$150 (per §33.24(6)(b) MGO)
- Comprehensive Design Review: \$500 (per §31.041(3)(d)(1)(a) MGO)
- Minor Alteration to a Comprehensive Sign Plan: \$100 (per §31.041(3)(d)(1)(c) MGO)
- All other sign requests to the Urban Design Commission, including, but not limited to: appeals from the decisions of the Zoning Administrator, requests for signage variances (i.e. modifications of signage height, area, and setback), and additional sign code approvals: \$300 (per §31.041(3)(d)(2) MGO)

A filing fee is not required for the following project applications if part of the combined application process involving both Urban Design Commission and Plan Commission:

- Project in the Downtown Core District (DC), Urban Mixed-Use District (UMX), or Mixed-Use Center District (MXC)
- Project in the Suburban Employment Center District (SEC), Campus Institutional District (CI), or Employment Campus District (EC)
- Planned Development (PD): General Development Plan (GDP) and/or Specific Implementation Plan (SIP)
- Planned Multi-Use Site or Residential Building Complex

CAPITOL VIEW AT OAK PARK

Letter of Intent

To: The City of Madison Plan Commission

We are submitting the following minor amendment to this project, which was originally submitted back in 2016. The site plan, landscape plan, building footprint, and exterior materials remain essentially the same. The minor modifications for which we are seeking approval are:

- Unit quantity and mix within the footprint (and therefore modifications to balcony and exterior window locations)

Capitol View at Oak Park, located in Grandview Commons, is an age restricted apartment complex to be marketed toward older adults. The density of 99 apartment and condominium units is consistent with the GDP for the proposed site. The proposal conforms to both the Grandview Commons overall development plan & the Town Center plan. We have discussed the modifications with Veridian and they have given their approval of the design.

The unchanged project goal is to offer a quality constructed and architecturally interesting housing alternative for older adults in this part of Madison.

1. The name of the project: Capitol View at Oak Park
2. Construction schedule: Spring 2022 Start Construction
3. Description of existing conditions: Vacant infill lots in multi-family area of Grandview Commons
4. Owner: Jupiter Drive Investors, LLC – Contact: Scott Frank
5. Contractor: To be determined
6. Architect: Architectural Design Consultants, Inc. – Contact: Bradley R Servin, AIA
7. Landscape Architect: Landscape Architecture Contact: Joe Hanauer
8. Civil Engineer: Professional Engineering – Contact: Roxanne Johnson
9. Owner Representative: Hayden Frank
10. Uses of Building: Market rate apartments ranging in the size from 700 SF to 1,500 SF. The unit mix will include 1 bedroom with den; 2 bedroom, 2 bath; 2 bedroom, 2 bath with den; and 2 bedroom, 2.5 bath with den. The project will have covered parking for 101 cars, bicycle parking & common amenities include a gathering room with outdoor patio, roof terrace, fitness room and secure storage.
11. Total footprint: 170,325 SF

12. Square footage (acreage) of the site: 2.28 acres – 99,232 SF

13. Total number of dwelling units = 99 units

17. Trash Removal: Each unit owner will take their trash to a central collection point in the building. A private trash hauler will pick up trash on a regular basis.

18. Snow removal and maintenance for project: will be hired out to a private firm; therefore no equipment will be stored at the property.



**Architectural Design
Consultants, Inc.**

CAPITOL VIEW



**Architectural Design
Consultants, Inc.**

CAPITOL VIEW

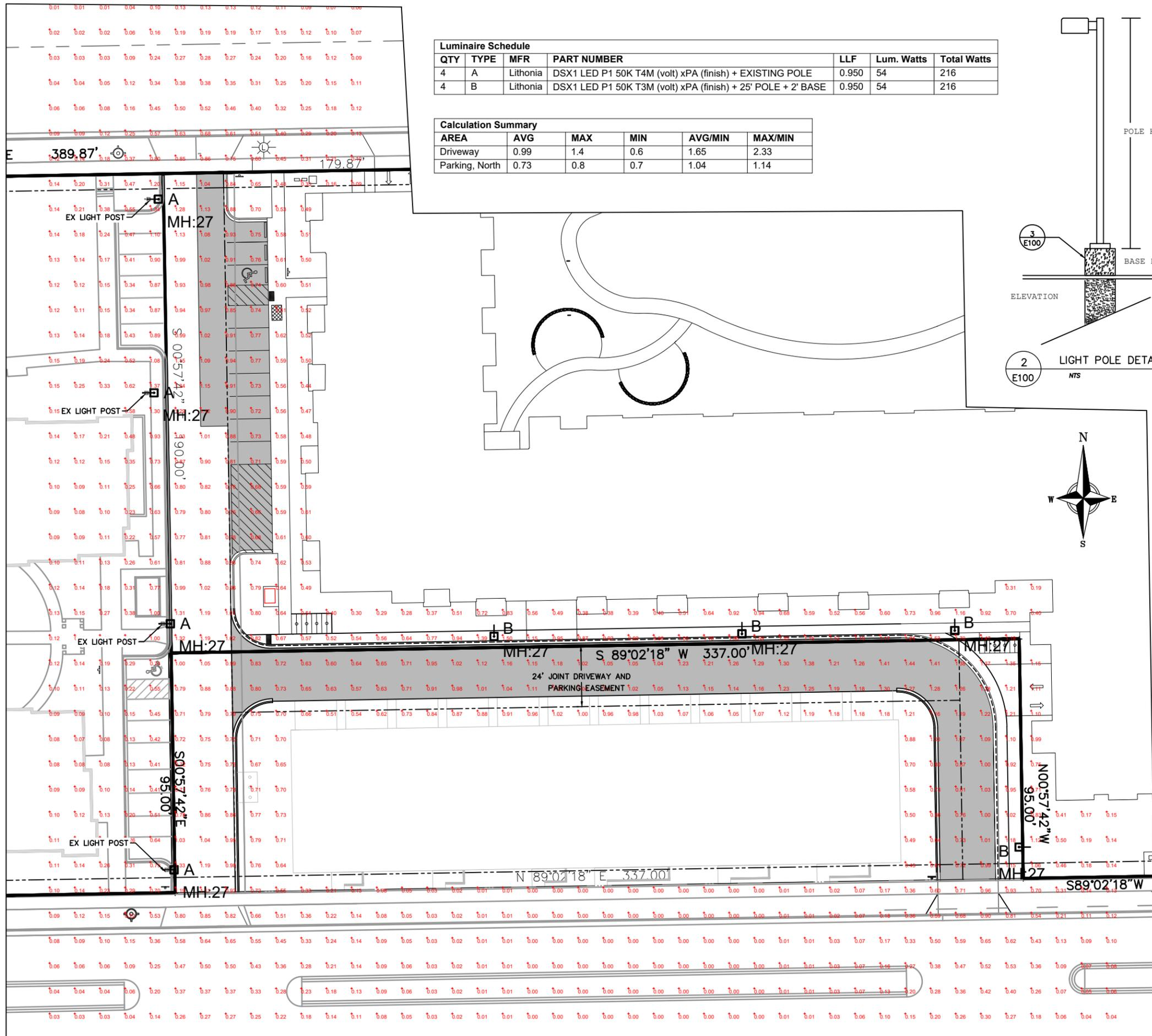

Luminaire Schedule						
QTY	TYPE	MFR	PART NUMBER	LLF	Lum. Watts	Total Watts
4	A	Lithonia	DSX1 LED P1 50K T4M (volt) xPA (finish) + EXISTING POLE	0.950	54	216
4	B	Lithonia	DSX1 LED P1 50K T3M (volt) xPA (finish) + 25' POLE + 2' BASE	0.950	54	216

Calculation Summary					
AREA	AVG	MAX	MIN	AVG/MIN	MAX/MIN
Driveway	0.99	1.4	0.6	1.65	2.33
Parking, North	0.73	0.8	0.7	1.04	1.14

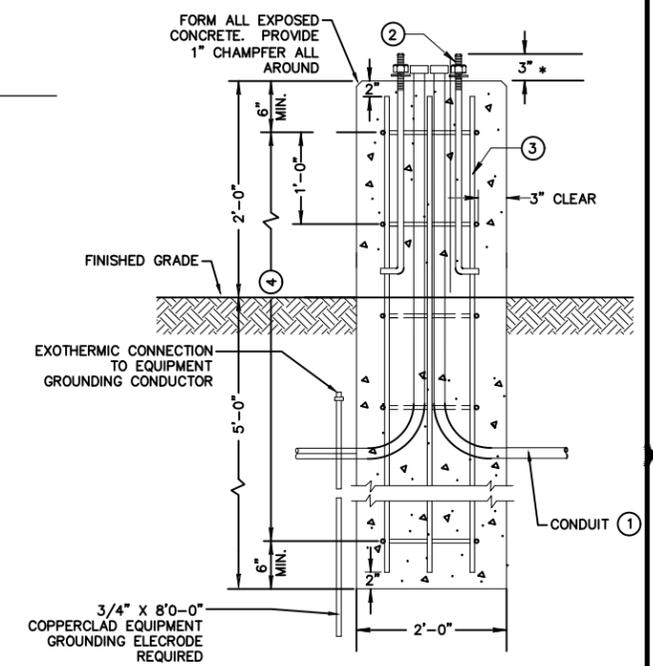
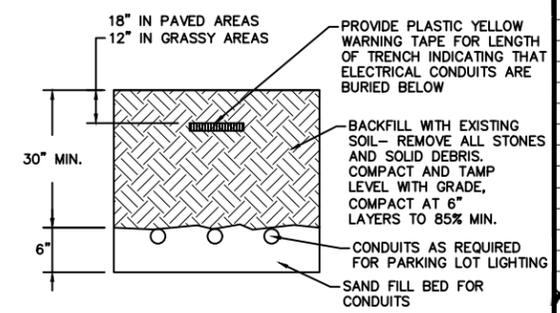
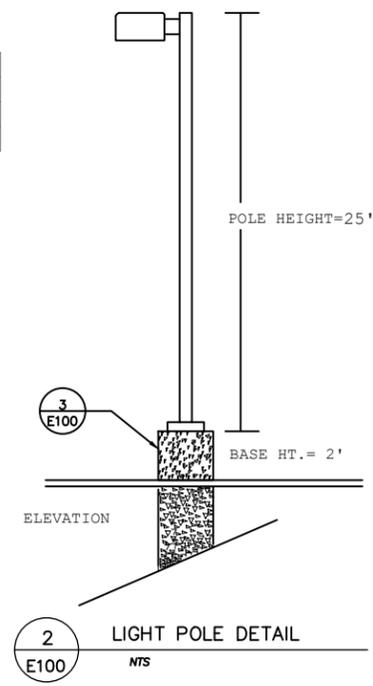

- THE MINIMUM DEPTH OF CONDUIT EXITING THE CONCRETE BASE AND INSTALLED BELOW THE TRAVELED WAY SHALL BE 24 INCHES. THE MINIMUM DEPTH OF CONDUIT EXITING THE CONCRETE BASE THAT IS NOT INSTALLED BELOW THE TRAVELED WAY SHALL BE 18 INCHES. THE MAXIMUM DEPTH OF ALL CONDUIT SHALL BE 36 INCHES EXCEPT WITH WRITTEN APPROVAL BY THE ENGINEER.
- ANCHOR BOLTS PER MANUFACTURER'S INSTRUCTIONS
- (6) NO.4 X 4'-8" BAR STEEL REINFORCEMENT.
- (5) NO.4 X 5'-1" BAR STEEL REINFORCEMENT @ 1'-0" C-C.

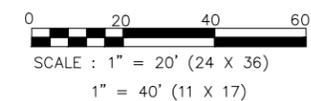

PROFESSIONAL ENGINEERING
 818 N Meadowbrook Ln
 Waunakee, WI 53597
 Phone: (608) 849-9378

REVISION

ADCI Architectural Design Consultants, Inc.
 5100 Eastpark Boulevard • Suite 310
 Madison, WI 53718
 Phone: (608) 254-6181 Fax: (608) 254-2139
 This document contains confidential or proprietary information of Architectural Design Consultants, Inc. Neither this document nor the information herein is to be reproduced, distributed, used or disclosed either in whole or in part except as specifically authorized by Architectural Design Consultants, Inc.

ADCI

CAPITOL VIEW APARTMENTS
 WISCONSIN

LIGHTING PLAN

Drawn By: K. JOHNSON
 Checked By: R. JOHNSON
 Date: 10-06-21
 Scale: AS NOTED
 Job Number: 21-01G

SHEET NUMBER
E100



NORTH ELEVATION

SCALE: 1/16" = 1'-0"



SOUTH ELEVATION

SCALE: 1/16" = 1'-0"



EAST ELEVATION

SCALE: 1/16" = 1'-0"



WEST ELEVATION

SCALE: 1/16" = 1'-0"

EXTERIOR FINISH SCHEDULE		
BOX	MATERIAL / MANUFACTURER	DESCRIPTION / COLOR
A	ALUMINUM SIDING / LONGBOARD SOFFIT	DARK CHERRY
B	6" COMPOSITE LAP SIDING / LP SMARTSIDE	TUNDRA GRAY
C	6" COMPOSITE BOARD AND BATTEN SIDING / LP SMARTSIDE	SNOWSCAPE WHITE
D	STONE VENEER / FOND DU LAC STONE	HAMILTON DIMENSIONAL
E	MANUF STONE CAP / FOND DU LAC STONE	---



**Architectural Design
Consultants, Inc.**

CAPITOL VIEW

EXTERIOR FINISH SCHEDULE		
BOX	MATERIAL / MANUFACTURER	DESCRIPTION / COLOR
A	ALUMINUM SIDING / LONGBOARD SOFFIT	DARK CHERRY
B	6" COMPOSITE LAP SIDING / LP SMARTSIDE	TUNDRA GRAY
C	6" COMPOSITE BOARD AND BATTEN SIDING / LP SMARTSIDE	SNOWSCAPE WHITE
D	STONE VENEER / FOND DU LAC STONE	HAMILTON DIMENSIONAL
E	MANUF. STONE CAP / FOND DU LAC STONE	---



NORTH ELEVATION

SCALE: 1/16" = 1'-0"



SOUTH ELEVATION

SCALE: 1/16" = 1'-0"



EAST ELEVATION

SCALE: 1/16" = 1'-0"



WEST ELEVATION

SCALE: 1/16" = 1'-0"



**Architectural Design
Consultants, Inc.**

CAPITOL VIEW



FON DU LAC STONE
HAMILTON DIMENSIONAL



LONGBOARD SIDING
ALUMINUM WOOD GRAIN 6" V GROOVE



LP SMARTSIDE BOARD & BATTEN
SHERWIN WILLIAMS EVERGREEN FOG



LP SMARTSIDE TRIM
SNOWSCAPE WHITE

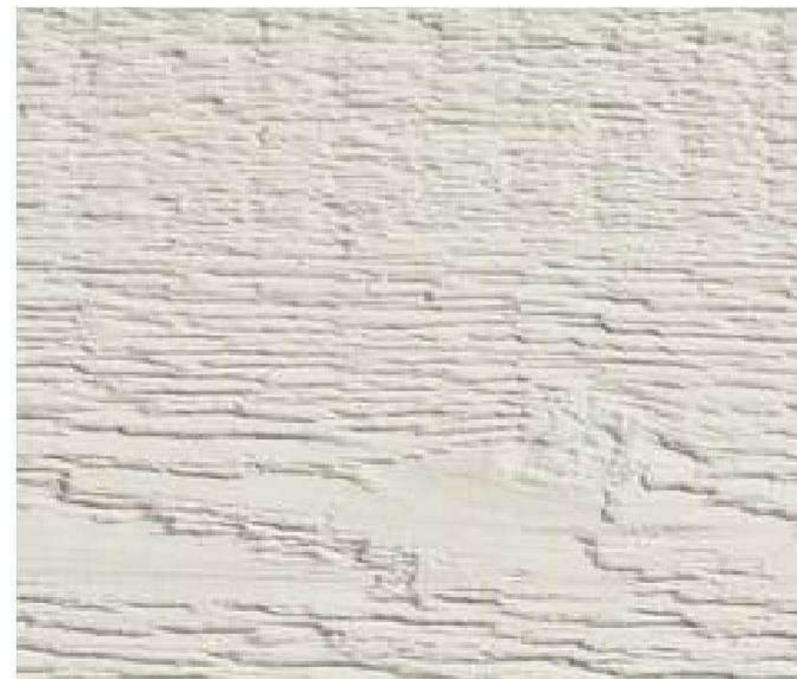

LP SMARTSIDE SIDING
6" EXPOSURE QUARRY GRAY



**Architectural Design
Consultants, Inc.**

CAPITOL VIEW



**Architectural Design
Consultants, Inc.**

CAPITOL VIEW



**Architectural Design
Consultants, Inc.**

CAPITOL VIEW



**Architectural Design
Consultants, Inc.**

CAPITOL VIEW



**Architectural Design
Consultants, Inc.**

CAPITOL VIEW



719 JUPITER DR



5837 GEMINI DRIVE



769 NORTH STAR



5801 GEMINI DRIVE



**Architectural Design
Consultants, Inc.**

CAPITOL VIEW



734 JUPITER DR



818 NORTH STAR DRIVE



NORTH STAR DRIVE



**Architectural Design
Consultants, Inc.**

CAPITOL VIEW



Fond du Lac™
stone Inc.
FOND DU LAC DIMENSIONAL

www.fdlstone.com





LP SmartSide®
TRIM & SIDING





D-Series Size 1 LED Area Luminaire

d^{series}



Catalog Number
Notes
Type

Hit the Tab key or mouse over the page to see all interactive elements.

Specifications

EPA:	1.01 ft ² (0.09 m ²)
Length:	33" (83.8 cm)
Width:	13" (33.0 cm)
Height H1:	7-1/2" (19.0 cm)
Height H2:	3-1/2"
Weight (max):	27 lbs (12.2 kg)

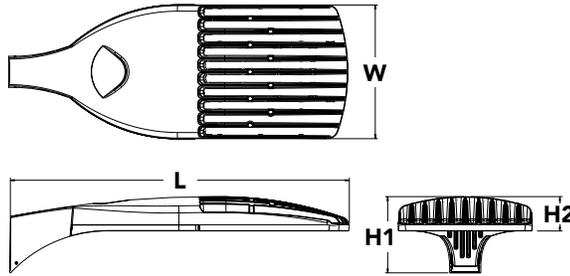

Introduction

The modern styling of the D-Series is striking yet unobtrusive - making a bold, progressive statement even as it blends seamlessly with its environment. The D-Series distills the benefits of the latest in LED technology into a high performance, high efficacy, long-life luminaire.

The outstanding photometric performance results in sites with excellent uniformity, greater pole spacing and lower power density. It is ideal for replacing up to 750W metal halide in pedestrian and area lighting applications with typical energy savings of 65% and expected service life of over 100,000 hours.

Ordering Information

EXAMPLE: DSX1 LED P7 40K T3M MVOLT SPA NLTAIR2 PIRHN DDBXD

Series	LEDs	Color temperature	Distribution	Voltage	Mounting
DSX1 LED	Forward optics P1 P4 ¹ P7 ¹ P2 P5 ¹ P8 P3 P6 ¹ P9 ¹ Rotated optics P10 ² P12 ² P11 ² P13 ^{1,2}	30K 3000 K 40K 4000 K 50K 5000 K	T1S Type I short (Automotive) T2S Type II short T2M Type II medium T3S Type III short T3M Type III medium T4M Type IV medium TFTM Forward throw medium T5VS Type V very short ³ T5S Type V short ³ T5M Type V medium ³ T5W Type V wide ³ BLC Backlight control ⁴ LCCO Left corner cutoff ⁴ RCCO Right corner cutoff ⁴	MVOLT ⁵ XVOLT (277V-480V) ^{6,7,8} 120 ⁹ 208 ⁹ 240 ⁹ 277 ⁹ 347 ⁹ 480 ⁹	Shipped included SPA Square pole mounting RPA Round pole mounting ¹⁰ WBA Wall bracket ³ SPUMBA Square pole universal mounting adaptor ¹¹ RPUMBA Round pole universal mounting adaptor ⁹ Shipped separately KMA8 DDBXD U Mast arm mounting bracket adaptor (specify finish) ¹²

Control options	Other options	Finish (required)
Shipped installed NLTAIR2 nLight AIR generation 2 enabled ¹³ PIRHN Network, high/low motion/ambient sensor ¹⁴ PER NEMA twist-lock receptacle only (controls ordered separate) ¹⁵ PER5 Five-pin receptacle only (controls ordered separate) ^{15,16} PER7 Seven-pin receptacle only (controls ordered separate) ^{15,16} DMG 0-10v dimming wires pulled outside fixture (for use with an external control, ordered separately) ¹⁷ DS Dual switching ^{18,19,20}	PIR High/low, motion/ambient sensor, 8-15' mounting height, ambient sensor enabled at 5fc ^{20,21} PIRH High/low, motion/ambient sensor, 15-30' mounting height, ambient sensor enabled at 5fc ^{20,21} PIR1FC3V High/low, motion/ambient sensor, 8-15' mounting height, ambient sensor enabled at 1fc ^{20,21} PIRH1FC3V Bi-level, motion/ambient sensor, 15-30' mounting height, ambient sensor enabled at 1fc ^{20,21} FAO Field adjustable output ^{20,21}	Shipped installed HS House-side shield ²³ SF Single fuse (120, 277, 347V) ⁹ DF Double fuse (208, 240, 480V) ⁹ L90 Left rotated optics ² R90 Right rotated optics ² HA 50°C ambient operations ¹ BAA Buy America(n) Act Compliant Shipped separately BS Bird spikes ²⁴ EGS External glare shield
		DDBXD Dark bronze DBLXD Black DNAXD Natural aluminum DWHXD White DDBTXD Textured dark bronze DBLBXD Textured black DNATXD Textured natural aluminum DWHGXD Textured white



Ordering Information

Accessories

Ordered and shipped separately.

DLL127F 1.5 JU	Photocell - SSL twist-lock (120-277V) ²⁵
DLL347F 1.5 CUL JU	Photocell - SSL twist-lock (347V) ²⁵
DLL480F 1.5 CUL JU	Photocell - SSL twist-lock (480V) ²⁵
DSHORT SBK U	Shorting cap ²⁵
DSX1HS 30C U	House-side shield for P1, P2, P3, P4 and P5 ²³
DSX1HS 40C U	House-side shield for P6 and P7 ²³
DSX1HS 60C U	House-side shield for P8, P9, P10, P11 and P12 ²³
PUMBA DDBXD U*	Square and round pole universal mounting bracket (specify finish) ²⁵
KMA8 DDBXD U	Mast arm mounting bracket adaptor (specify finish) ¹²
DSX1EGS (FINISH) U	External glare shield

For more control options, visit [DTL](#) and [ROAM](#) online.

NOTES

- 1 HA not available with P4, P5, P6, P7, P9 and P13.
- 2 P10, P11, P12 or P13 and rotated optics (L90, R90) only available together.
- 3 Any Type 5 distribution with photocell, is not available with WBA.
- 4 Not available with HS.
- 5 MVOLT driver operates on any line voltage from 120-277V (50/60 Hz).
- 6 XVOLT only suitable for use with P3, P5, P6, P7, P9 and P13.
- 7 XVOLT works with any voltage between 277V and 480V.
- 8 XVOLT not available with fusing (SF or DF) and not available with PIR, PIRH, PIR1FC3V, PIRH1FC3V.
- 9 Single fuse (SF) requires 120V, 277V or 347V. Double fuse (DF) requires 208V, 240V or 480V. XVOLT not available with fusing (SF or DF).
- 10 Suitable for mounting to round poles between 3.5" and 12" diameter.
- 11 Universal mounting brackets intended for retrofit on existing, pre-drilled poles only. 1.5 G vibration load rating per ANCI C136.31. Only usable when pole's drill pattern is NOT Lithonia template #8.
- 12 Must order fixture with SPA option. Must be ordered as a separate accessory; see Accessories information. For use with 2-3/8" diameter mast arm (not included).
- 13 Must be ordered with PIRHN. Sensor cover available only in dark bronze, black, white and natural aluminum colors.
- 14 Must be ordered with NLTAIR2. For more information on nLight Air 2 visit [this link](#).
- 15 Photocell ordered and shipped as a separate line item from Acuity Brands Controls. See accessories. Shorting cap included.
- 16 If ROAM® node required, it must be ordered and shipped as a separate line item from Acuity Brands Controls. Node with integral dimming.
- 17 DMG not available with PIRHN, PER5, PER7, PIR, PIRH, PIR1FC3V or PIRH1FC3V, FAO.
- 18 Provides 50/50 fixture operation via (2) independent drivers. Not available with PER, PER5, PER7, PIR or PIRH. Not available P1, P2, P3, P4 or P5.
- 19 Requires (2) separately switched circuits with isolated neutral.
- 20 Reference Controls Option Default settings table on page 4.
- 21 Reference Motion Sensor table on page 4 to see functionality.
- 22 Not available with other dimming controls options.
- 23 Not available with BLC, LCCO and RCCO distribution. Also available as a separate accessory; see Accessories information.
- 24 Must be ordered with fixture for factory pre-drilling.
- 25 Requires luminaire to be specified with PER, PER5 or PER7 option. See Control Option Table on page 4.
- 26 For retrofit use only. Only usable when pole's drill pattern is NOT Lithonia template #8.

Options

EGS - External Glare Shield

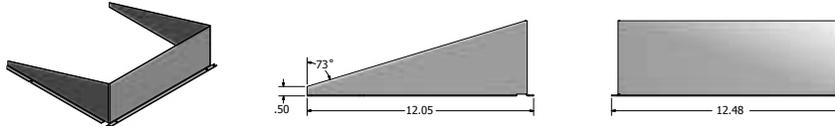

Drilling

HANDHOLE ORIENTATION

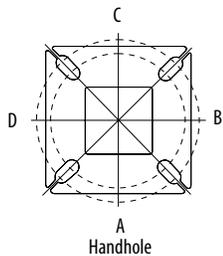

Tenon Mounting Slipfitter

Tenon O.D.	Mounting	Single Unit	2 @ 180	2 @ 90	3 @ 90	3 @ 120	4 @ 90
2-3/8"	RPA	AS3-5 190	AS3-5 280	AS3-5 290	AS3-5 390	AS3-5 320	AS3-5 490
2-7/8"	RPA	AST25-190	AST25-280	AST25-290	AST25-390	AST25-320	AST25-490
4"	RPA	AST35-190	AST35-280	AST35-290	AST35-390	AST35-320	AST35-490

Mounting Option	Drilling Template	Single	2 @ 180	2 @ 90	3 @ 90	3 @ 120	4 @ 90
Head Location		Side B	Side B & D	Side B & C	Side B, C & D	Round Pole Only	Side A, B, C & D
Drill Nomenclature	#8	DM19AS	DM28AS	DM29AS	DM39AS	DM32AS	DM49AS

DSX1 Area Luminaire - EPA

*Includes luminaire and integral mounting arm. Other tenons, arms, brackets or other accessories are not included in this EPA data.

Fixture Quantity & Mounting Configuration	Single DM19	2 @ 180 DM28	2 @ 90 DM29	3 @ 90 DM39	3 @ 120 DM32	4 @ 90 DM49
Mounting Type						
DSX1 LED	1.013	2.025	1.945	3.038	2.850	3.749

	Drilling Template	Minimum Acceptable Outside Pole Dimension					
SPA	#8	2-7/8"	2-7/8"	3.5"	3.5"	3"	3.5"
RPA	#8	2-7/8"	2-7/8"	3.5"	3.5"	3"	3.5"
SPUMBA	#5	2-7/8"	3"	4"	4"	3.5"	4"
RPUMBA	#5	2-7/8"	3.5"	5"	5"	3.5"	5"

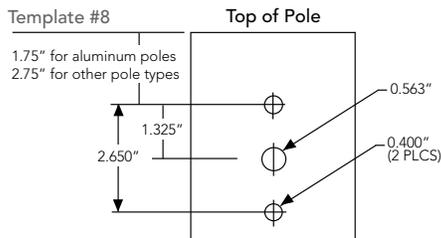

Photometric Diagrams

To see complete photometric reports or download .ies files for this product, visit Lithonia Lighting's [D-Series Area Size 1 homepage](#).

Isofootcandle plots for the DSX1 LED 60C 1000 40K. Distances are in units of mounting height (25').

LEGEND

- 0.1 fc
- 0.5 fc
- 1.0 fc

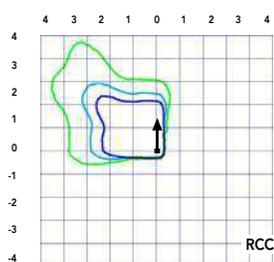
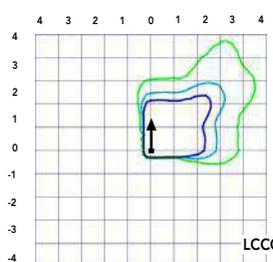
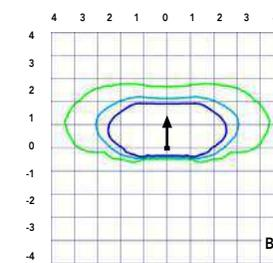
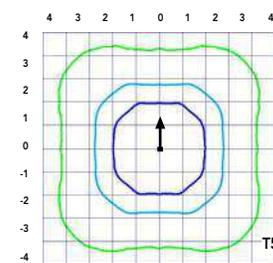
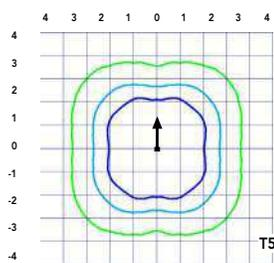
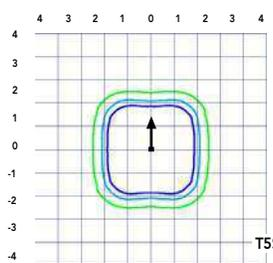
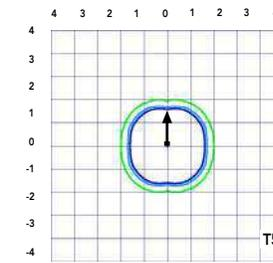
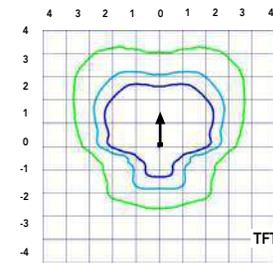
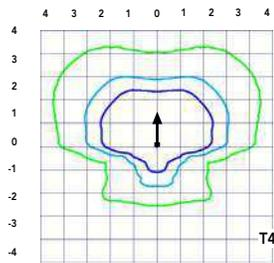
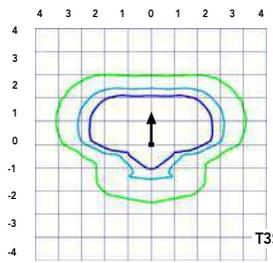
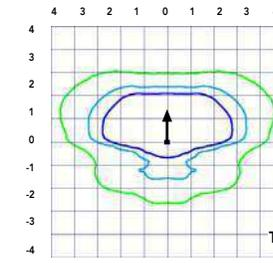
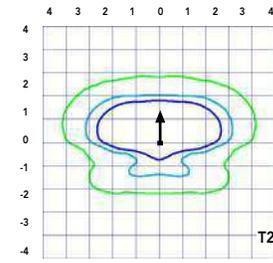
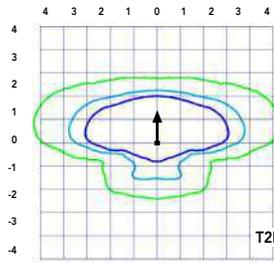
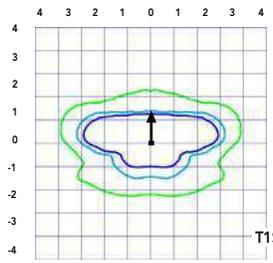

Performance Data

Lumen Ambient Temperature (LAT) Multipliers

Use these factors to determine relative lumen output for average ambient temperatures from 0-40°C (32-104°F).

Ambient		Lumen Multiplier
0°C	32°F	1.04
5°C	41°F	1.04
10°C	50°F	1.03
15°C	59°F	1.02
20°C	68°F	1.01
25°C	77°F	1.00
30°C	86°F	0.99
35°C	95°F	0.98
40°C	104°F	0.97

Projected LED Lumen Maintenance

Data references the extrapolated performance projections for the platforms noted in a **25°C ambient**, based on 10,000 hours of LED testing (tested per IESNA LM-80-08 and projected per IESNA TM-21-11).

To calculate LLF, use the lumen maintenance factor that corresponds to the desired number of operating hours below. For other lumen maintenance values, contact factory.

Operating Hours	Lumen Maintenance Factor
0	1.00
25,000	0.96
50,000	0.92
100,000	0.85

Motion Sensor Default Settings

Option	Dimmed State	High Level (when triggered)	Photocell Operation	Dwell Time	Ramp-up Time	Ramp-down Time
PIR or PIRH	3V (37%) Output	10V (100%) Output	Enabled @ 5FC	5 min	3 sec	5 min
*PIR1FC3V or PIRH1FC3V	3V (37%) Output	10V (100%) Output	Enabled @ 1FC	5 min	3 sec	5 min

*for use when motion sensor is used as dusk to dawn control.

Electrical Load

	Performance Package	LED Count	Drive Current	Wattage	Current (A)					
					120	208	240	277	347	480
Forward Optics (Non-Rotated)	P1	30	530	54	0.45	0.26	0.23	0.19	0.10	0.12
	P2	30	700	70	0.59	0.34	0.30	0.25	0.20	0.16
	P3	30	1050	102	0.86	0.50	0.44	0.38	0.30	0.22
	P4	30	1250	125	1.06	0.60	0.52	0.46	0.37	0.27
	P5	30	1400	138	1.16	0.67	0.58	0.51	0.40	0.29
	P6	40	1250	163	1.36	0.78	0.68	0.59	0.47	0.34
	P7	40	1400	183	1.53	0.88	0.76	0.66	0.53	0.38
	P8	60	1050	207	1.74	0.98	0.87	0.76	0.64	0.49
	P9	60	1250	241	2.01	1.16	1.01	0.89	0.70	0.51
Rotated Optics (Requires L90 or R90)	P10	60	530	106	0.90	0.52	0.47	0.43	0.33	0.27
	P11	60	700	137	1.15	0.67	0.60	0.53	0.42	0.32
	P12	60	1050	207	1.74	0.99	0.87	0.76	0.60	0.46
	P13	60	1250	231	1.93	1.12	0.97	0.86	0.67	0.49

Controls Options

Nomenclature	Description	Functionality	Primary control device	Notes
FA0	Field adjustable output device installed inside the luminaire; wired to the driver dimming leads.	Allows the luminaire to be manually dimmed, effectively trimming the light output.	FA0 device	Cannot be used with other controls options that need the 0-10V leads
DS	Drivers wired independently for 50/50 luminaire operation	The luminaire is wired to two separate circuits, allowing for 50/50 operation.	Independently wired drivers	Requires two separately switched circuits. Consider nLight AIR as a more cost effective alternative.
PERS or PER7	Twist-lock photocell receptacle	Compatible with standard twist-lock photocells for dusk to dawn operation, or advanced control nodes that provide 0-10V dimming signals.	Twist-lock photocells such as DLL Elite or advanced control nodes such as ROAM.	Pins 4 & 5 to dimming leads on driver, Pins 6 & 7 are capped inside luminaire
PIR or PIRH	Motion sensors with integral photocell. PIR for 8-15' mounting; PIRH for 15-30' mounting	luminaires dim when no occupancy is detected.	Acuity Controls SBGR	Also available with PIRH1FC3V when the sensor photocell is used for dusk-to-dawn operation.
NLTAIR2 PIRHN	nLight AIR enabled luminaire for motion sensing, photocell and wireless communication.	Motion and ambient light sensing with group response. Scheduled dimming with motion sensor over-ride when wirelessly connected to the nLight Eclipse.	nLight Air rSDGR	nLight AIR sensors can be programmed and commissioned from the ground using the CIAIRity Pro app.

Performance Data

Lumen Output

Lumen values are from photometric tests performed in accordance with IESNA LM-79-08. Data is considered to be representative of the configurations shown, within the tolerances allowed by Lighting Facts Contact factory for performance data on any configurations not shown here.

Forward Optics																			
LED Count	Drive Current	Power Package	System Watts	Dist. Type	30K (3000 K, 70 CRI)					40K (4000 K, 70 CRI)					50K (5000 K, 70 CRI)				
					Lumens	B	U	G	LPW	Lumens	B	U	G	LPW	Lumens	B	U	G	LPW
30	530	P1	54W	T1S	6,457	2	0	2	120	6,956	2	0	2	129	7,044	2	0	2	130
				T2S	6,450	2	0	2	119	6,949	2	0	2	129	7,037	2	0	2	130
				T2M	6,483	1	0	1	120	6,984	2	0	2	129	7,073	2	0	2	131
				T3S	6,279	2	0	2	116	6,764	2	0	2	125	6,850	2	0	2	127
				T3M	6,468	1	0	2	120	6,967	1	0	2	129	7,056	1	0	2	131
				T4M	6,327	1	0	2	117	6,816	1	0	2	126	6,902	1	0	2	128
				TFTM	6,464	1	0	2	120	6,963	1	0	2	129	7,051	1	0	2	131
				TSVS	6,722	2	0	0	124	7,242	3	0	0	134	7,334	3	0	0	136
				T5S	6,728	2	0	1	125	7,248	2	0	1	134	7,340	2	0	1	136
				T5M	6,711	3	0	1	124	7,229	3	0	1	134	7,321	3	0	2	136
				TSW	6,667	3	0	2	123	7,182	3	0	2	133	7,273	3	0	2	135
				BLC	5,299	1	0	1	98	5,709	1	0	2	106	5,781	1	0	2	107
				LCCO	3,943	1	0	2	73	4,248	1	0	2	79	4,302	1	0	2	80
				RCCO	3,943	1	0	2	73	4,248	1	0	2	79	4,302	1	0	2	80
30	700	P2	70W	T1S	8,249	2	0	2	118	8,886	2	0	2	127	8,999	2	0	2	129
				T2S	8,240	2	0	2	118	8,877	2	0	2	127	8,989	2	0	2	128
				T2M	8,283	2	0	2	118	8,923	2	0	2	127	9,036	2	0	2	129
				T3S	8,021	2	0	2	115	8,641	2	0	2	123	8,751	2	0	2	125
				T3M	8,263	2	0	2	118	8,901	2	0	2	127	9,014	2	0	2	129
				T4M	8,083	2	0	2	115	8,708	2	0	2	124	8,818	2	0	2	126
				TFTM	8,257	2	0	2	118	8,896	2	0	2	127	9,008	2	0	2	129
				TSVS	8,588	3	0	0	123	9,252	3	0	0	132	9,369	3	0	0	134
				T5S	8,595	3	0	1	123	9,259	3	0	1	132	9,376	3	0	1	134
				T5M	8,573	3	0	2	122	9,236	3	0	2	132	9,353	3	0	2	134
				TSW	8,517	3	0	2	122	9,175	4	0	2	131	9,291	4	0	2	133
				BLC	6,770	1	0	2	97	7,293	1	0	2	104	7,386	1	0	2	106
				LCCO	5,038	1	0	2	72	5,427	1	0	2	78	5,496	1	0	2	79
				RCCO	5,038	1	0	2	72	5,427	1	0	2	78	5,496	1	0	2	79
30	1050	P3	102W	T1S	11,661	2	0	2	114	12,562	3	0	3	123	12,721	3	0	3	125
				T2S	11,648	2	0	2	114	12,548	3	0	3	123	12,707	3	0	3	125
				T2M	11,708	2	0	2	115	12,613	2	0	2	124	12,773	2	0	2	125
				T3S	11,339	2	0	2	111	12,215	3	0	3	120	12,370	3	0	3	121
				T3M	11,680	2	0	2	115	12,582	2	0	2	123	12,742	2	0	2	125
				T4M	11,426	2	0	3	112	12,309	2	0	3	121	12,465	2	0	3	122
				TFTM	11,673	2	0	2	114	12,575	2	0	3	123	12,734	2	0	3	125
				TSVS	12,140	3	0	1	119	13,078	3	0	1	128	13,244	3	0	1	130
				T5S	12,150	3	0	1	119	13,089	3	0	1	128	13,254	3	0	1	130
				T5M	12,119	4	0	2	119	13,056	4	0	2	128	13,221	4	0	2	130
				TSW	12,040	4	0	3	118	12,970	4	0	3	127	13,134	4	0	3	129
				BLC	9,570	1	0	2	94	10,310	1	0	2	101	10,440	1	0	2	102
				LCCO	7,121	1	0	3	70	7,671	1	0	3	75	7,768	1	0	3	76
				RCCO	7,121	1	0	3	70	7,671	1	0	3	75	7,768	1	0	3	76
30	1250	P4	125W	T1S	13,435	3	0	3	107	14,473	3	0	3	116	14,657	3	0	3	117
				T2S	13,421	3	0	3	107	14,458	3	0	3	116	14,641	3	0	3	117
				T2M	13,490	2	0	2	108	14,532	3	0	3	116	14,716	3	0	3	118
				T3S	13,064	3	0	3	105	14,074	3	0	3	113	14,252	3	0	3	114
				T3M	13,457	2	0	2	108	14,497	2	0	2	116	14,681	2	0	2	117
				T4M	13,165	2	0	3	105	14,182	2	0	3	113	14,362	2	0	3	115
				TFTM	13,449	2	0	3	108	14,488	2	0	3	116	14,672	2	0	3	117
				TSVS	13,987	4	0	1	112	15,068	4	0	1	121	15,259	4	0	1	122
				T5S	13,999	3	0	1	112	15,080	3	0	1	121	15,271	3	0	1	122
				T5M	13,963	4	0	2	112	15,042	4	0	2	120	15,233	4	0	2	122
				TSW	13,872	4	0	3	111	14,944	4	0	3	120	15,133	4	0	3	121
				BLC	11,027	1	0	2	88	11,879	1	0	2	95	12,029	1	0	2	96
				LCCO	8,205	1	0	3	66	8,839	1	0	3	71	8,951	1	0	3	72
				RCCO	8,205	1	0	3	66	8,839	1	0	3	71	8,951	1	0	3	72
30	1400	P5	138W	T1S	14,679	3	0	3	106	15,814	3	0	3	115	16,014	3	0	3	116
				T2S	14,664	3	0	3	106	15,797	3	0	3	114	15,997	3	0	3	116
				T2M	14,739	3	0	3	107	15,878	3	0	3	115	16,079	3	0	3	117
				T3S	14,274	3	0	3	103	15,377	3	0	3	111	15,572	3	0	3	113
				T3M	14,704	2	0	3	107	15,840	3	0	3	115	16,040	3	0	3	116
				T4M	14,384	2	0	3	104	15,496	3	0	3	112	15,692	3	0	3	114
				TFTM	14,695	2	0	3	106	15,830	3	0	3	115	16,030	3	0	3	116
				TSVS	15,283	4	0	1	111	16,464	4	0	1	119	16,672	4	0	1	121
				T5S	15,295	3	0	1	111	16,477	4	0	1	119	16,686	4	0	1	121
				T5M	15,257	4	0	2	111	16,435	4	0	2	119	16,644	4	0	2	121
				TSW	15,157	4	0	3	110	16,328	4	0	3	118	16,534	4	0	3	120
				BLC	12,048	1	0	2	87	12,979	1	0	2	94	13,143	1	0	2	95
				LCCO	8,965	1	0	3	65	9,657	1	0	3	70	9,780	1	0	3	71
				RCCO	8,965	1	0	3	65	9,657	1	0	3	70	9,780	1	0	3	71



Performance Data

Lumen Output

Lumen values are from photometric tests performed in accordance with IESNA LM-79-08. Data is considered to be representative of the configurations shown, within the tolerances allowed by Lighting Facts. Contact factory for performance data on any configurations not shown here.

Forward Optics																			
LED Count	Drive Current	Power Package	System Watts	Dist. Type	30K (3000 K, 70 CRI)					40K (4000 K, 70 CRI)					50K (5000 K, 70 CRI)				
					Lumens	B	U	G	LPW	Lumens	B	U	G	LPW	Lumens	B	U	G	LPW
40	1250	P6	163W	T1S	17,654	3	0	3	108	19,018	3	0	3	117	19,259	3	0	3	118
				T2S	17,635	3	0	3	108	18,998	3	0	3	117	19,238	3	0	3	118
				T2M	17,726	3	0	3	109	19,096	3	0	3	117	19,337	3	0	3	119
				T3S	17,167	3	0	3	105	18,493	3	0	3	113	18,727	3	0	3	115
				T3M	17,683	3	0	3	108	19,049	3	0	3	117	19,290	3	0	3	118
				T4M	17,299	3	0	3	106	18,635	3	0	4	114	18,871	3	0	4	116
				TFTM	17,672	3	0	3	108	19,038	3	0	4	117	19,279	3	0	4	118
				TSVS	18,379	4	0	1	113	19,800	4	0	1	121	20,050	4	0	1	123
				T5S	18,394	4	0	2	113	19,816	4	0	2	122	20,066	4	0	2	123
				T5M	18,348	4	0	2	113	19,766	4	0	2	121	20,016	4	0	2	123
				TSW	18,228	5	0	3	112	19,636	5	0	3	120	19,885	5	0	3	122
				BLC	14,489	2	0	2	89	15,609	2	0	3	96	15,806	2	0	3	97
				LCCO	10,781	1	0	3	66	11,614	1	0	3	71	11,761	2	0	3	72
				RCCO	10,781	1	0	3	66	11,614	1	0	3	71	11,761	2	0	3	72
40	1400	P7	183W	T1S	19,227	3	0	3	105	20,712	3	0	3	113	20,975	3	0	3	115
				T2S	19,206	3	0	3	105	20,690	3	0	3	113	20,952	3	0	3	114
				T2M	19,305	3	0	3	105	20,797	3	0	3	114	21,060	3	0	3	115
				T3S	18,696	3	0	3	102	20,141	3	0	3	110	20,396	3	0	4	111
				T3M	19,258	3	0	3	105	20,746	3	0	3	113	21,009	3	0	3	115
				T4M	18,840	3	0	4	103	20,296	3	0	4	111	20,553	3	0	4	112
				TFTM	19,246	3	0	4	105	20,734	3	0	4	113	20,996	3	0	4	115
				TSVS	20,017	4	0	1	109	21,564	4	0	1	118	21,837	4	0	1	119
				T5S	20,033	4	0	2	109	21,581	4	0	2	118	21,854	4	0	2	119
				T5M	19,983	4	0	2	109	21,527	5	0	3	118	21,799	5	0	3	119
				TSW	19,852	5	0	3	108	21,386	5	0	3	117	21,656	5	0	3	118
				BLC	15,780	2	0	3	86	16,999	2	0	3	93	17,214	2	0	3	94
				LCCO	11,742	2	0	3	64	12,649	2	0	3	69	12,809	2	0	3	70
				RCCO	11,742	2	0	3	64	12,649	2	0	3	69	12,809	2	0	3	70
60	1050	P8	207W	T1S	22,490	3	0	3	109	24,228	3	0	3	117	24,535	3	0	3	119
				T2S	22,466	3	0	4	109	24,202	3	0	4	117	24,509	3	0	4	118
				T2M	22,582	3	0	3	109	24,327	3	0	3	118	24,635	3	0	3	119
				T3S	21,870	3	0	4	106	23,560	3	0	4	114	23,858	3	0	4	115
				T3M	22,527	3	0	4	109	24,268	3	0	4	117	24,575	3	0	4	119
				T4M	22,038	3	0	4	106	23,741	3	0	4	115	24,041	3	0	4	116
				TFTM	22,513	3	0	4	109	24,253	3	0	4	117	24,560	3	0	4	119
				TSVS	23,415	5	0	1	113	25,224	5	0	1	122	25,543	5	0	1	123
				T5S	23,434	4	0	2	113	25,244	4	0	2	122	25,564	4	0	2	123
				T5M	23,374	5	0	3	113	25,181	5	0	3	122	25,499	5	0	3	123
				TSW	23,221	5	0	4	112	25,016	5	0	4	121	25,332	5	0	4	122
				BLC	18,458	2	0	3	89	19,885	2	0	3	96	20,136	2	0	3	97
				LCCO	13,735	2	0	3	66	14,796	2	0	4	71	14,983	2	0	4	72
				RCCO	13,735	2	0	3	66	14,796	2	0	4	71	14,983	2	0	4	72
60	1250	P9	241W	T1S	25,575	3	0	3	106	27,551	3	0	3	114	27,900	3	0	3	116
				T2S	25,548	3	0	4	106	27,522	3	0	4	114	27,871	3	0	4	116
				T2M	25,680	3	0	3	107	27,664	3	0	3	115	28,014	3	0	3	116
				T3S	24,870	3	0	4	103	26,791	3	0	4	111	27,130	3	0	4	113
				T3M	25,617	3	0	4	106	27,597	3	0	4	115	27,946	3	0	4	116
				T4M	25,061	3	0	4	104	26,997	3	0	4	112	27,339	3	0	4	113
				TFTM	25,602	3	0	4	106	27,580	3	0	4	114	27,929	3	0	4	116
				TSVS	26,626	5	0	1	110	28,684	5	0	1	119	29,047	5	0	1	121
				T5S	26,648	4	0	2	111	28,707	5	0	2	119	29,070	5	0	2	121
				T5M	26,581	5	0	3	110	28,635	5	0	3	119	28,997	5	0	3	120
				TSW	26,406	5	0	4	110	28,447	5	0	4	118	28,807	5	0	4	120
				BLC	20,990	2	0	3	87	22,612	2	0	3	94	22,898	2	0	3	95
				LCCO	15,619	2	0	4	65	16,825	2	0	4	70	17,038	2	0	4	71
				RCCO	15,619	2	0	4	65	16,825	2	0	4	70	17,038	2	0	4	71

Lumen Output

Lumen values are from photometric tests performed in accordance with IESNA LM-79-08. Data is considered to be representative of the configurations shown, within the tolerances allowed by Lighting Facts. Contact factory for performance data on any configurations not shown here.

Rotated Optics																			
LED Count	Drive Current	Power Package	System Watts	Dist. Type	30K (3000 K, 70 CRI)					40K (4000 K, 70 CRI)					50K (5000 K, 70 CRI)				
					Lumens	B	U	G	LPW	Lumens	B	U	G	LPW	Lumens	B	U	G	LPW
60	530	P10	106W	T1S	13,042	3	0	3	123	14,050	3	0	3	133	14,228	3	0	3	134
				T2S	12,967	4	0	4	122	13,969	4	0	4	132	14,146	4	0	4	133
				T2M	13,201	3	0	3	125	14,221	3	0	3	134	14,401	3	0	3	136
				T3S	12,766	4	0	4	120	13,752	4	0	4	130	13,926	4	0	4	131
				T3M	13,193	4	0	4	124	14,213	4	0	4	134	14,393	4	0	4	136
				T4M	12,944	4	0	4	122	13,945	4	0	4	132	14,121	4	0	4	133
				TFTM	13,279	4	0	4	125	14,305	4	0	4	135	14,486	4	0	4	137
				TSVS	13,372	3	0	1	126	14,405	4	0	1	136	14,588	4	0	1	138
				T5S	13,260	3	0	1	125	14,284	3	0	1	135	14,465	3	0	1	136
				T5M	13,256	4	0	2	125	14,281	4	0	2	135	14,462	4	0	2	136
				TSW	13,137	4	0	3	124	14,153	4	0	3	134	14,332	4	0	3	135
				BLC	10,906	3	0	3	103	11,749	3	0	3	111	11,898	3	0	3	112
				LCCO	7,789	1	0	3	73	8,391	1	0	3	79	8,497	1	0	3	80
				RCCO	7,779	4	0	4	73	8,380	4	0	4	79	8,486	4	0	4	80
60	700	P11	137W	T1S	16,556	3	0	3	121	17,835	3	0	3	130	18,061	4	0	4	132
				T2S	16,461	4	0	4	120	17,733	4	0	4	129	17,957	4	0	4	131
				T2M	16,758	4	0	4	122	18,053	4	0	4	132	18,281	4	0	4	133
				T3S	16,205	4	0	4	118	17,457	4	0	4	127	17,678	4	0	4	129
				T3M	16,748	4	0	4	122	18,042	4	0	4	132	18,271	4	0	4	133
				T4M	16,432	4	0	4	120	17,702	4	0	4	129	17,926	4	0	4	131
				TFTM	16,857	4	0	4	123	18,159	4	0	4	133	18,389	4	0	4	134
				TSVS	16,975	4	0	1	124	18,287	4	0	1	133	18,518	4	0	1	135
				T5S	16,832	4	0	1	123	18,133	4	0	2	132	18,362	4	0	2	134
				T5M	16,828	4	0	2	123	18,128	4	0	2	132	18,358	4	0	2	134
				TSW	16,677	4	0	3	122	17,966	5	0	3	131	18,193	5	0	3	133
				BLC	13,845	3	0	3	101	14,915	3	0	3	109	15,103	3	0	3	110
				LCCO	9,888	1	0	3	72	10,652	2	0	3	78	10,787	2	0	3	79
				RCCO	9,875	4	0	4	72	10,638	4	0	4	78	10,773	4	0	4	79
60	1050	P12	207W	T1S	22,996	4	0	4	111	24,773	4	0	4	120	25,087	4	0	4	121
				T2S	22,864	4	0	4	110	24,631	5	0	5	119	24,943	5	0	5	120
				T2M	23,277	4	0	4	112	25,075	4	0	4	121	25,393	4	0	4	123
				T3S	22,509	4	0	4	109	24,248	5	0	5	117	24,555	5	0	5	119
				T3M	23,263	4	0	4	112	25,061	4	0	4	121	25,378	4	0	4	123
				T4M	22,824	5	0	5	110	24,588	5	0	5	119	24,899	5	0	5	120
				TFTM	23,414	5	0	5	113	25,223	5	0	5	122	25,543	5	0	5	123
				TSVS	23,579	5	0	1	114	25,401	5	0	1	123	25,722	5	0	1	124
				T5S	23,380	4	0	2	113	25,187	4	0	2	122	25,506	4	0	2	123
				T5M	23,374	5	0	3	113	25,181	5	0	3	122	25,499	5	0	3	123
				TSW	23,165	5	0	4	112	24,955	5	0	4	121	25,271	5	0	4	122
				BLC	19,231	4	0	4	93	20,717	4	0	4	100	20,979	4	0	4	101
				LCCO	13,734	2	0	3	66	14,796	2	0	4	71	14,983	2	0	4	72
				RCCO	13,716	4	0	4	66	14,776	4	0	4	71	14,963	4	0	4	72
60	1250	P13	231W	T1S	25,400	4	0	4	110	27,363	4	0	4	118	27,709	4	0	4	120
				T2S	25,254	5	0	5	109	27,205	5	0	5	118	27,550	5	0	5	119
				T2M	25,710	4	0	4	111	27,696	4	0	4	120	28,047	4	0	4	121
				T3S	24,862	5	0	5	108	26,783	5	0	5	116	27,122	5	0	5	117
				T3M	25,695	5	0	5	111	27,680	5	0	5	120	28,031	5	0	5	121
				T4M	25,210	5	0	5	109	27,158	5	0	5	118	27,502	5	0	5	119
				TFTM	25,861	5	0	5	112	27,860	5	0	5	121	28,212	5	0	5	122
				TSVS	26,043	5	0	1	113	28,056	5	0	1	121	28,411	5	0	1	123
				T5S	25,824	4	0	2	112	27,819	5	0	2	120	28,172	5	0	2	122
				T5M	25,818	5	0	3	112	27,813	5	0	3	120	28,165	5	0	3	122
				TSW	25,586	5	0	4	111	27,563	5	0	4	119	27,912	5	0	4	121
				BLC	21,241	4	0	4	92	22,882	4	0	4	99	23,172	4	0	4	100
				LCCO	15,170	2	0	4	66	16,342	2	0	4	71	16,549	2	0	4	72
				RCCO	15,150	5	0	5	66	16,321	5	0	5	71	16,527	5	0	5	72

FEATURES & SPECIFICATIONS

INTENDED USE

The sleek design of the D-Series Size 1 reflects the embedded high performance LED technology. It is ideal for many commercial and municipal applications, such as parking lots, plazas, campuses, and streetscapes.

CONSTRUCTION

Single-piece die-cast aluminum housing has integral heat sink fins to optimize thermal management through conductive and convective cooling. Modular design allows for ease of maintenance and future light engine upgrades. The LED drivers are mounted in direct contact with the casting to promote low operating temperature and long life. Housing is completely sealed against moisture and environmental contaminants (IP65). Low EPA (1.01 ft²) for optimized pole wind loading.

FINISH

Exterior parts are protected by a zinc-infused Super Durable TGIC thermoset powder coat finish that provides superior resistance to corrosion and weathering. A tightly controlled multi-stage process ensures a minimum 3 mils thickness for a finish that can withstand extreme climate changes without cracking or peeling. Available in both textured and non-textured finishes.

OPTICS

Precision-molded proprietary acrylic lenses are engineered for superior area lighting distribution, uniformity, and pole spacing. Light engines are available in standard 3000 K, 4000 K and 5000 K (70 CRI) configurations. The D-Series Size 1 has zero uplight and qualifies as a Nighttime Friendly™ product, meaning it is consistent with the LEED® and Green Globes™ criteria for eliminating wasteful uplight.

ELECTRICAL

Light engine configurations consist of high-efficacy LEDs mounted to metal-core circuit boards to maximize heat dissipation and promote long life (up to L85/100,000 hours at 25°C). Class 1 electronic drivers are designed to have a power factor >90%, THD <20%, and an expected life of 100,000 hours with <1% failure rate. Easily serviceable 10kV surge protection device meets a minimum Category C Low operation (per ANSI/IEEE C62.41.2).

STANDARD CONTROLS

The DSX1 LED area luminaire has a number of control options. DSX Size 1, comes standard with 0-10V dimming drivers. Dusk to dawn controls can be utilized via optional NEMA twist-lock photocell receptacles. Integrated motion sensors with on-board photocells feature field-adjustable programming and are suitable for mounting heights up to 30 feet.

nLIGHT AIR CONTROLS

The DSX1 LED area luminaire is also available with nLight® AIR for the ultimate in wireless control. This powerful controls platform provides out-of-the-box basic motion sensing and photocontrol functionality and is suitable for mounting heights up to 40 feet. Once commissioned using a smartphone and the easy-to-use CLAIRITY app, nLight AIR equipped luminaires can be grouped, resulting in motion sensor and photocell group response without the need for additional equipment. Scheduled dimming with motion sensor over-ride can be achieved when used with the nLight Eclipse. Additional information about nLight Air can be found here.

INSTALLATION

Included mounting block and integral arm facilitate quick and easy installation. Stainless steel bolts fasten the mounting block securely to poles and walls, enabling the D-Series Size 1 to withstand up to a 3.0 G vibration load rating per ANSI C136.31. The D-Series Size 1 utilizes the AERIS™ series pole drilling pattern (template #8). NEMA photocontrol receptacle are also available.

LISTINGS

UL listed to meet U.S. and Canadian standards. UL Listed for wet locations. Light engines are IP66 rated; luminaire is IP65 rated. Rated for -40°C minimum ambient. U.S. Patent No. D672,492 S. International patent pending.

DesignLights Consortium® (DLC) Premium qualified product and DLC qualified product. Not all versions of this product may be DLC Premium qualified or DLC qualified. Please check the DLC Qualified Products List at www.designlights.org/QPL to confirm which versions are qualified.

International Dark-Sky Association (IDA) Fixture Seal of Approval (FSA) is available for all products on this page utilizing 3000K color temperature only.

BUY AMERICAN

Product with the BAA option is assembled in the USA and meets the Buy America(n) government procurement requirements under FAR, DFARS and DOT. Please refer to www.acuitybrands.com/buy-american for additional information.

WARRANTY

5-year limited warranty. Complete warranty terms located at: www.acuitybrands.com/support/customer-support/terms-and-conditions

Note: Actual performance may differ as a result of end-user environment and application.

All values are design or typical values, measured under laboratory conditions at 25 °C.

Specifications subject to change without notice.

