

# URBAN DESIGN COMMISSION APPLICATION

# UDC

City of Madison  
Planning Division  
126 S. Hamilton St.  
P.O. Box 2985  
Madison, WI 53701-2985  
(608) 266-4635



## FOR OFFICE USE ONLY:

Paid \_\_\_\_\_ Receipt # \_\_\_\_\_  
Date received \_\_\_\_\_  
Received by \_\_\_\_\_  
Aldermanic District \_\_\_\_\_  
Zoning District \_\_\_\_\_  
Urban Design District \_\_\_\_\_  
Submittal reviewed by \_\_\_\_\_

Complete all sections of this application, including the desired meeting date and the action requested.

*If you need an interpreter, translator, materials in alternate formats or other accommodations to access these forms, please call the phone number above immediately.*

## 1. Project Information

Address: \_\_\_\_\_  
Title: \_\_\_\_\_

## 2. Application Type (check all that apply) and Requested Date

UDC meeting date requested \_\_\_\_\_

- New development       Alteration to an existing or previously-approved development  
 Informational       Initial approval       Final approval

## 3. Project Type

- Project in an Urban Design District  
 Project in the Downtown Core District (DC), Urban Mixed-Use District (UMX), or Mixed-Use Center District (MXC)  
 Project in the Suburban Employment Center District (SEC), Campus Institutional District (CI), or Employment Campus District (EC)  
 Planned Development (PD)  
     General Development Plan (GDP)  
     Specific Implementation Plan (SIP)  
 Planned Multi-Use Site or Residential Building Complex

### Signage

- Comprehensive Design Review (CDR)  
 Signage Variance (i.e. modification of signage height, area, and setback)

### Other

- Please specify \_\_\_\_\_

## 4. Applicant, Agent, and Property Owner Information

**Applicant name** \_\_\_\_\_ **Company** \_\_\_\_\_  
**Street address** \_\_\_\_\_ **City/State/Zip** \_\_\_\_\_  
**Telephone** \_\_\_\_\_ **Email** \_\_\_\_\_

**Project contact person** \_\_\_\_\_ **Company** \_\_\_\_\_  
**Street address** \_\_\_\_\_ **City/State/Zip** \_\_\_\_\_  
**Telephone** \_\_\_\_\_ **Email** \_\_\_\_\_

**Property owner (if not applicant)** \_\_\_\_\_  
**Street address** \_\_\_\_\_ **City/State/Zip** \_\_\_\_\_  
**Telephone** \_\_\_\_\_ **Email** \_\_\_\_\_

**5. Required Submittal Materials**

- Application Form**
- Letter of Intent**
  - If the project is within an Urban Design District, a summary of how the development proposal addresses the district criteria is required
  - For signage applications, a summary of how the proposed signage is consistent with the applicable CDR or Signage Variance review criteria is required.
- Development plans** (Refer to checklist provided below for plan details)
- Filing fee**
- Electronic Submittal\***

Each submittal must include fourteen (14) 11" x 17" collated paper copies. Landscape and Lighting plans (if required) must be full-sized. Please refrain from using plastic covers or spiral binding.

Both the paper copies and electronic copies must be submitted prior to the application deadline before an application will be scheduled for a UDC meeting. Late materials will not be accepted. A completed application form is required for each UDC appearance.

For projects also requiring Plan Commission approval, applicants must also have submitted an accepted application for Plan Commission consideration prior to obtaining any formal action (initial or final approval) from the UDC. All plans must be legible when reduced.

*\*Electronic copies of all items submitted in hard copy are required. Individual PDF files of each item submitted should be compiled on a CD or flash drive, or submitted via email to [udcapplications@cityofmadison.com](mailto:udcapplications@cityofmadison.com). The email must include the project address, project name, and applicant name. Electronic submittals via file hosting services (such as Dropbox.com) are not allowed. Applicants who are unable to provide the materials electronically should contact the Planning Division at (608) 266-4635 for assistance.*

**6. Applicant Declarations**

1. Prior to submitting this application, the applicant is required to discuss the proposed project with Urban Design Commission staff. This application was discussed with \_\_\_\_\_ on \_\_\_\_\_.
2. The applicant attests that all required materials are included in this submittal and understands that if any required information is not provided by the application deadline, the application will not be placed on an Urban Design Commission agenda for consideration.

Applicant name \_\_\_\_\_ Relationship to property \_\_\_\_\_

Authorized signature of **Property Owner**  Date \_\_\_\_\_

**7. Application Filing Fees**

Fees are required to be paid with the first application for either initial or final approval of a project, unless the project is part of the combined application process involving the Urban Design Commission in conjunction with Plan Commission and/or Common Council consideration. Make checks payable to City Treasurer. Credit cards may be used for application fees of less than \$1,000.

Please consult the schedule below for the appropriate fee for your request:

- Urban Design Districts: \$350 (per §35.24(6) MGO).
- Minor Alteration in the Downtown Core District (DC) or Urban Mixed-Use District (UMX) : \$150 (per §33.24(6)(b) MGO)
- Comprehensive Design Review: \$500 (per §31.041(3)(d)(1)(a) MGO)
- Minor Alteration to a Comprehensive Sign Plan: \$100 (per §31.041(3)(d)(1)(c) MGO)
- All other sign requests to the Urban Design Commission, including, but not limited to: appeals from the decisions of the Zoning Administrator, requests for signage variances (i.e. modifications of signage height, area, and setback), and additional sign code approvals: \$300 (per §31.041(3)(d)(2) MGO)

A filing fee is not required for the following project applications if part of the combined application process involving both Urban Design Commission and Plan Commission:

- Project in the Downtown Core District (DC), Urban Mixed-Use District (UMX), or Mixed-Use Center District (MXC)
- Project in the Suburban Employment Center District (SEC), Campus Institutional District (CI), or Employment Campus District (EC)
- Planned Development (PD): General Development Plan (GDP) and/or Specific Implementation Plan (SIP)
- Planned Multi-Use Site or Residential Building Complex

# HILTON GARDEN INN



770 REGENT STREET | MADISON, WISCONSIN

# LETTER OF INTENT

THE PROPOSED HILTON GARDEN INN OCCUPIES A UNIQUE SITE NORTH OF REGENT STREET, EAST OF EAST CAMPUS MALL, AND SOUTH OF THE SOUTHWEST COMMUTER BIKE TRAIL. THE HOTEL DOESN'T HOLD ANY TRADITIONAL RIGHT-OF-WAY FRONTAGE AS IT IS BEING DEVELOPED ON SURFACE PARKING LOTS BEHIND EXISTING BUILDINGS WHICH FRONT THE STREET. THE CONDITION REQUIRES THE HOTEL TO SEEK SOME EXCEPTIONS TO THE EXISTING SIGN CODE TO MAINTAIN COMMERCIAL VIABILITY.

THE HOTEL HAS A SIGNAGE PROGRAM WHICH INCLUDES THE REPLACEMENT OF AN EXISTING MONUMENT SIGN LOCATED ALONG REGENT STREET. THIS NEW MONUMENT SIGN WILL SERVE THE EXISTING OFFICE BUILDING AND PROVIDE SIGNAGE TO THE HOTEL AND THIS IS CONSISTENT WITH THE SIGN CODE.

THE HOTEL HAS ONE WALL SIGN WHICH IS POSITIONED ON THE CANOPY EDGE CENTERED OVER THE FRONT DOOR. WE ARE SEEKING A LETTER HEIGHT OF 3'-0" WHICH IS SLIGHTLY LARGER THAN WHAT IS PERMITTED. THIS INCREASED SIZE IS NOT OUT OF SCALE OF THE BUILDING AND HELPS IDENTIFY THE BUILDING ENTRY FROM A DISTANCE OF ABOUT 220' FROM THE STREET.

ADDITIONALLY, THE HOTEL IS SEEKING TWO BLADE SIGNS. TYPICALLY BLADE SIGNS WOULD BE POSITIONED ON THE FACE OF THE BUILDING AND PROJECT OUT SO THEY ARE VISIBLE TO CARS PASSING BY ON A RIGHT-OF-WAY. SINCE THIS BUILDING IS SET BACK WITH ANOTHER BUILDING BETWEEN IT AND THE RIGHT-OF-WAY, WE NEED TO CONSIDER AN ALTERNATE POSITION OF LOCATING THE SIGNS ON THE ENDS OF THE BUILDING SO THE BLADE SIGNS ARE READ FROM THE STREET BEYOND. WE ARE CONSISTENT WITH THE MAXIMUM HEIGHT BEING LIMITED TO OUR 3RD FLOOR LINE AND ARE KEEPING THEM 16' ABOVE GRADE, BUT ARE SEEKING A SLIGHTLY LARGER SIGN DUE TO THE DISTANCE AT WHICH IT IS SEEN FROM THE RIGHT-OF-WAY.

OTHER SIGNS PROPOSED INCLUDE A AS-OF-RIGHT SIZED POST-AND-PANEL DIRECTIONAL MONUMENT POSITIONED NEAR THE BIKE TRAIL ENTRY, A PARKING CIRCLE TO IDENTIFY PARKING ACCESS, AND PEDESTRIAN-SCALED WALL PLAQUE REQUIRED BY THE HOTEL BRAND AT THE FRONT DOOR.

THE DESIGN OF THESE SIGNS ARE OF A HIGH QUALITY, COMPLEMENT THE BUILDING, AND CONTRIBUTE TO THE BRAND IDENTIFY AND VIABILITY OF THE PROJECT.

# COMPREHENSIVE DESIGN REVIEW CRITERIA

**1. THE PROPOSAL SHALL CREATE VISUAL HARMONY BETWEEN THE SIGNS, BUILDING(S), AND BUILDING SITE THROUGH UNIQUE AND EXCEPTIONAL USE OF MATERIALS, DESIGN, COLOR, ANY LIGHTING, AND OTHER DESIGN ELEMENTS; AND SHALL RESULT IN SIGNS OF APPROPRIATE SCALE AND CHARACTER TO THE USES AND BUILDING(S) ON THE ZONING LOT AS WELL AS ADJACENT BUILDINGS, STRUCTURES AND USES.**

THE SIGNAGE DESIGN AT THE HILTON GARDEN INN HAS BEEN DESIGNED TO MEET THE CRITERIA. THE SIZE OF THE SIGNS PROPOSED ARE COMMENSURATE WITH THE SCALE OF THE BUILDING AND THE DISTANCE AT WHICH THEY CAN BE VIEWED. THE SIGNS ARE ALL HIGH QUALITY CONSTRUCTION GENERALLY WITH ROUTED ALUMINUM FACES WITH PUSH THROUGH ILLUMINATED LETTERING. TO THE GREATEST EXTENT PRACTICAL, THE PROPOSED SIGNS ARE CODE COMPLIANCE FOR SIZE, WITH A FEW EXCEPTIONS DEEMED APPROPRIATE FOR BUILDING SCALE AND LEGIBILITY REASONS.

**2. EACH ELEMENT SHALL BE FOUND TO BE NECESSARY DUE TO UNIQUE OR UNUSUAL DESIGN ASPECTS IN THE ARCHITECTURE OR LIMITATIONS IN THE BUILDING SITE OR SURROUNDING ENVIRONMENT; EXCEPT THAT WHEN A REQUEST FOR AN ADDITIONAL SIGN CODE APPROVAL UNDER SEC. 31.043(3) IS INCLUDED IN THE COMPREHENSIVE DESIGN REVIEW, THE SIGN(S) ELIGIBLE FOR APPROVAL UNDER SEC. 31.043(3) SHALL MEET THE APPLICABLE CRITERIA OF SEC. 31.043(3), EXCEPT THAT SIGN APPROVALS THAT COME TO COMPREHENSIVE DESIGN REVIEW FROM MXC AND EC DISTRICTS PURSUANT TO 31.13(3) AND (7) NEED NOT MEET THE CRITERIA OF THIS PARAGRAPH.**

THE SITE PRESENTS UNIQUE CHALLENGES TO THE TYPICAL DEVELOPMENT WHICH IS WHAT THE SIGN CODE IS INTENDED TO REGULATE. THIS PROJECT IS A HOTEL (WHICH HAS TRANSIENT NON-REGULAR VISITORS) SITUATED WITHIN AN EXISTING DEVELOPMENT OF OFFICE BUILDINGS. THE HOTEL IS SET BACK FROM ANY PUBLIC RIGHT-OF-WAY DESIGNED FOR VEHICULAR TRAVEL AND BEHIND THE OFFICE BUILDINGS. THE CLOSEST RIGHT-OF-WAY IS REGENT STREET AND ITS VISTA TO THE BUILDING IS WELL OVER 200 FEET AWAY, AND TYPICALLY THROUGH A SLOTTED VIEW SHED FLANKED BY EXISTING BUILDINGS. THE BLADE SIGNS, FOR EXAMPLE, ARE TYPICALLY POSITIONED PERPENDICULAR TO THE RIGHT-OF-WAY WHICH, IN THIS CASE, WOULD NOT PERMIT THEM TO BE VISIBLE TO THE RIGHT-OF-WAY. THE SIGNS ON THIS PROJECT HAVE BEEN PLACED FOR MAXIMUM IMPACT FOR THESE REASONS, THIS PROJECT IS SEEKING A COMPREHENSIVE DESIGN REVIEW WITH A FEW EXCEPTIONS TO THE SIGN CODE.

**3. THE PROPOSAL SHALL NOT VIOLATE ANY OF THE STATED PURPOSES DESCRIBED IN SECS. 31.02(1) AND 33.24(2).**

THE SIGN DESIGN IS CONSISTENT WITH THE GOALS OF SAFETY AND AESTHETICS OUTLINED IN THE ABOVE SECTIONS.

**4. ALL SIGNS MUST MEET MINIMUM CONSTRUCTION REQUIREMENTS UNDER SEC. 31.04(5).**

THE SIGN CONSTRUCTION WILL MEET THE REQUIREMENTS LISTED IN THE ABOVE SECTION.

**5. THE PROPOSAL SHALL NOT APPROVE ADVERTISING BEYOND THE RESTRICTIONS IN SEC. 31.11 OR OFF-PREMISE DIRECTIONAL SIGNS BEYOND THE RESTRICTIONS IN SEC. 31.115.**

THE SIGN PROGRAM ADHERES TO THE RESTRICTIONS IDENTIFIED IN THE ABOVE SECTION.

**6. THE PROPOSAL SHALL NOT BE APPROVED IF ANY ELEMENT OF THE PLAN:**

- A. PRESENTS A HAZARD TO VEHICULAR OR PEDESTRIAN TRAFFIC ON PUBLIC OR PRIVATE PROPERTY,**
- B. OBSTRUCTS VIEWS AT POINTS OF INGRESS AND EGRESS OF ADJOINING PROPERTIES,**
- C. OBSTRUCTS OR IMPEDES THE VISIBILITY OF EXISTING LAWFUL SIGNS ON ADJACENT PROPERTY, OR**
- D. NEGATIVELY IMPACTS THE VISUAL QUALITY OF PUBLIC OR PRIVATE OPEN SPACE.**

THE SIGN PROGRAM COMPLIES WITH THE ABOVE CRITERIA..

**7. THE PROPOSAL MAY ONLY ENCOMPASS SIGNS ON PRIVATE PROPERTY OF THE ZONING LOT OR BUILDING SITE IN QUESTION, AND SHALL NOT APPROVE ANY SIGNS IN THE RIGHT OF WAY OR ON PUBLIC PROPERTY.**

THE SIGN PROGRAM COMPLIES WITH THE ABOVE CRITERIA..

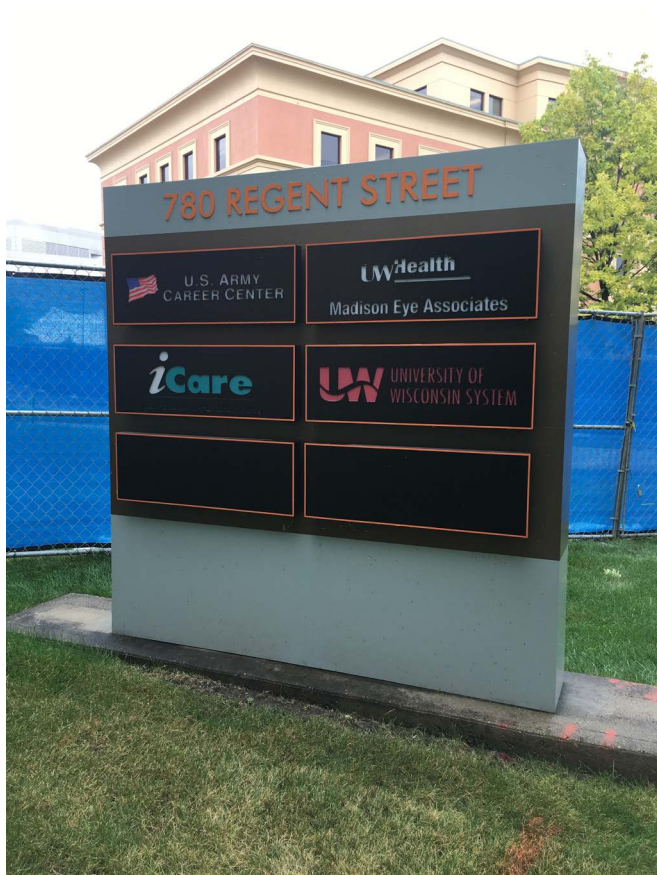

**SITE CONTEXT PHOTOS**

UDC SIGNAGE CDR SUBMITTAL | 08-28-2019 | PAGE 04

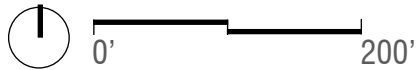
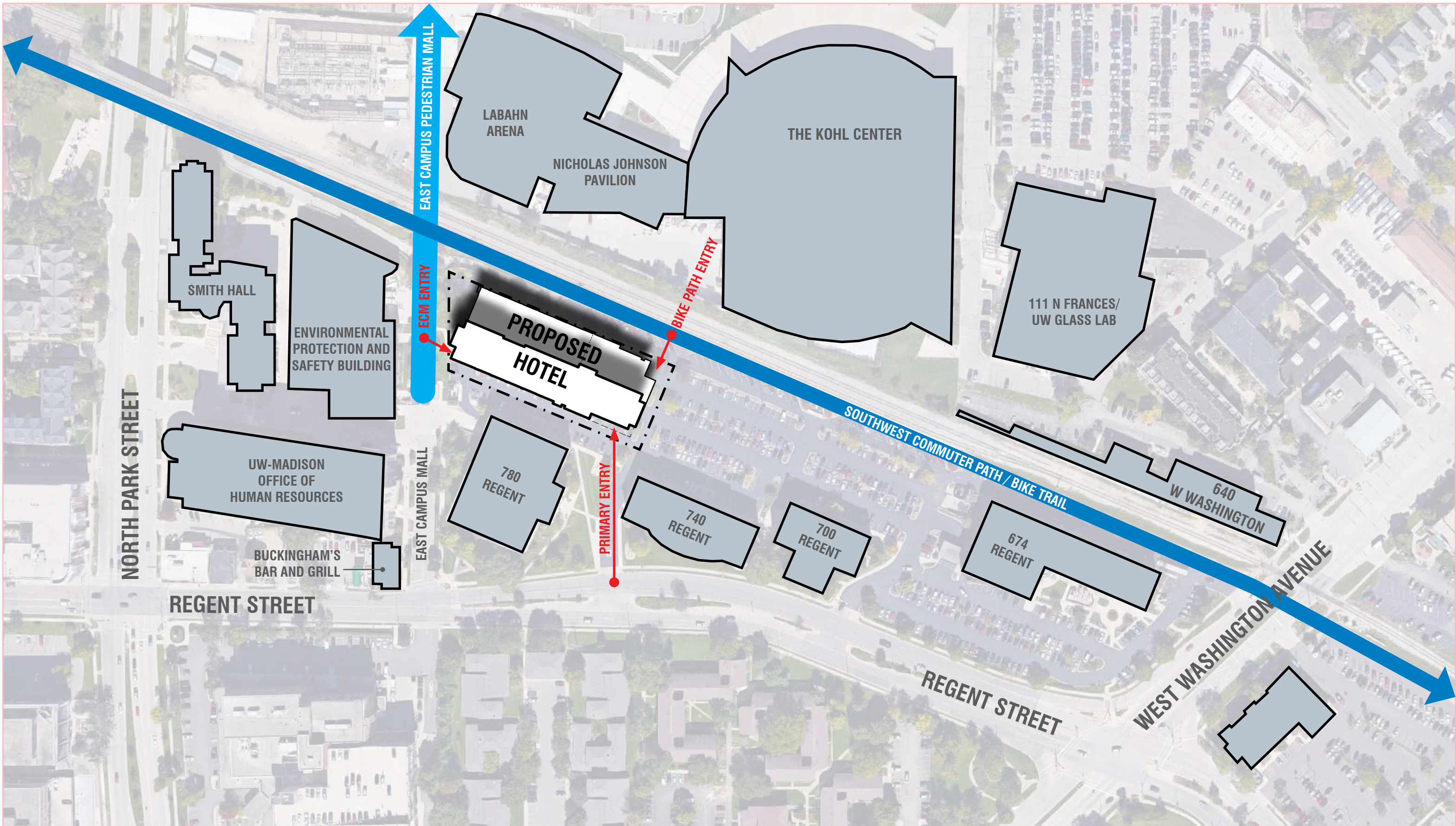

**LOCATOR MAP**

UDC SIGNAGE CDR SUBMITTAL | 08-28-2019 | PAGE 05



**HILTON GARDEN INN**  
MADISON, WISCONSIN



COPYRIGHT © 2019 KAHLER SLATER, INC. ALL RIGHTS RESERVED

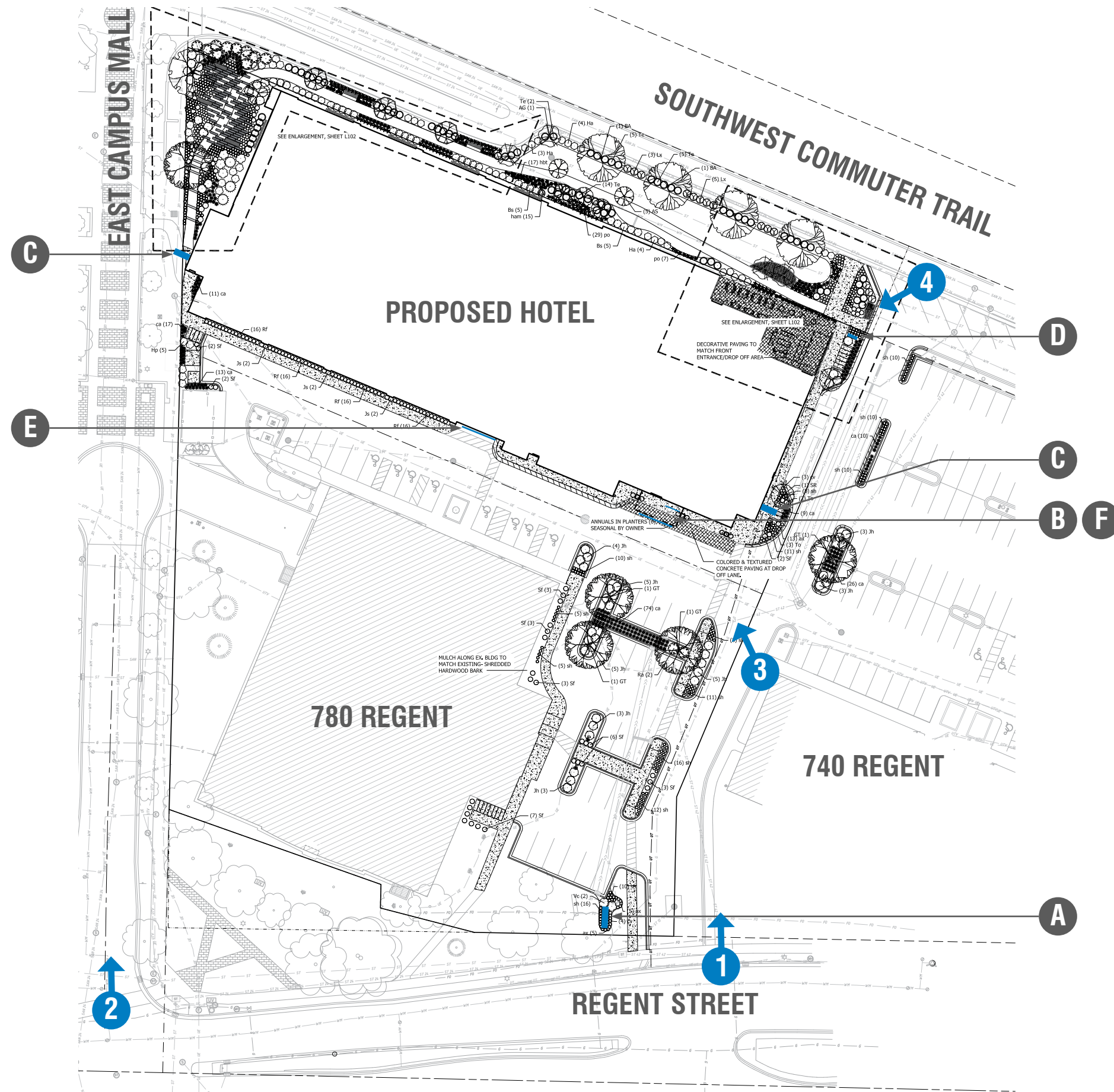

**SIGN LOCATION PLAN**

UDC SIGNAGE CDR SUBMITTAL | 08-28-2019 | PAGE 06

**Kahler Slater**  
 COPYRIGHT © 2019 KAHLER SLATER, INC. ALL RIGHTS RESERVED



**HILTON GARDEN INN**  
 MADISON, WISCONSIN



# A MONUMENT

GROUND-MOUNTED MONUMENT SIGN LOCATED AT REGENT STREET PRIMARY VEHICULAR ENTRY. REPLACES EXISTING SIGN. (QTY 1). REFER TO DETAILED SIGN DRAWINGS ATTACHED FOR MORE INFORMATION.

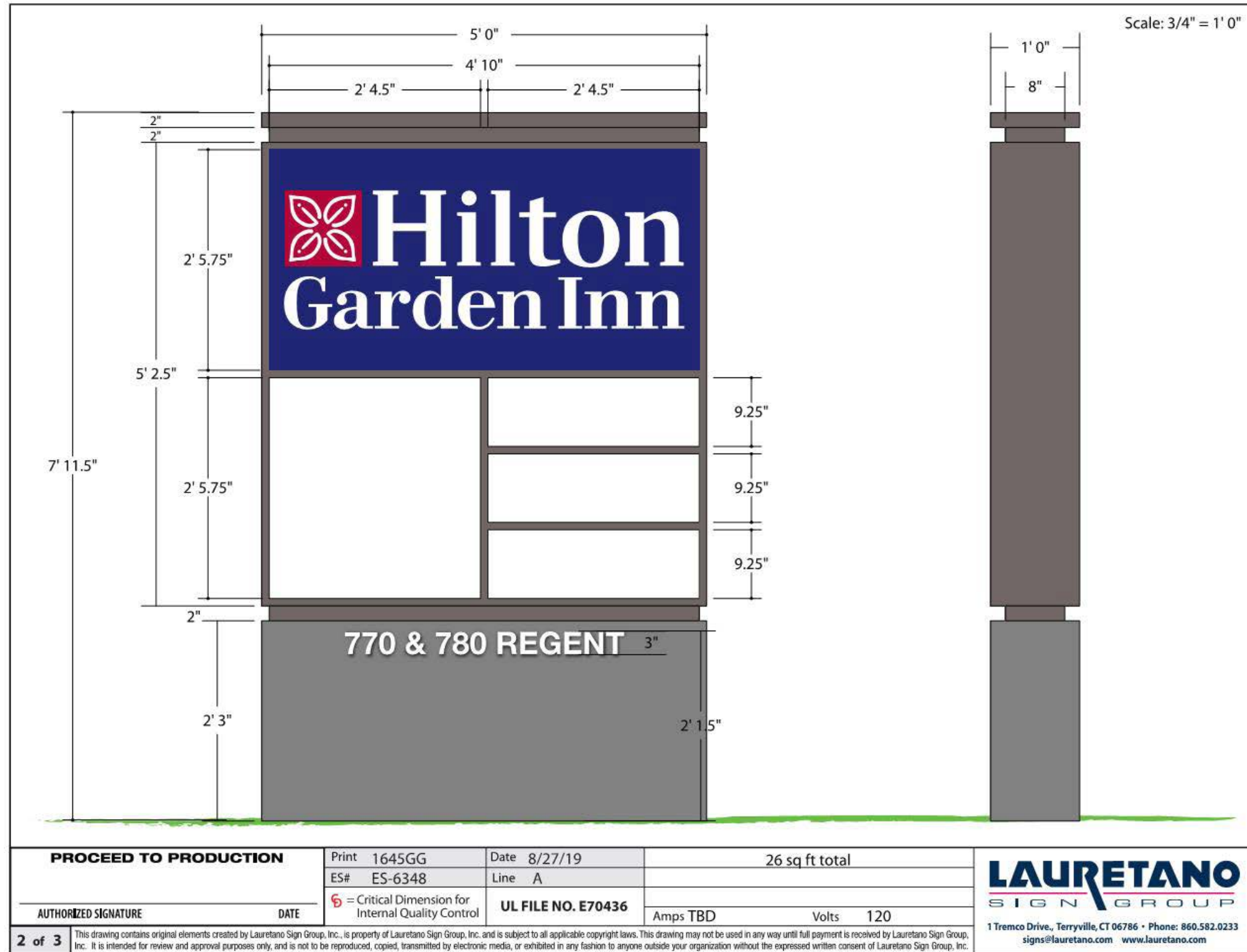

## SIGN TYPES

UDC SIGNAGE CDR SUBMITTAL | 08-28-2019 | PAGE 07

**Kahler Slater**  
COPYRIGHT © 2019 KAHLER SLATER, INC. ALL RIGHTS RESERVED

## B MAIN ENTRY

FREESTANDING INDIVIDUAL CHANNEL LETTERS WALL SIGN MOUNTED ABOVE BUILDING ENTRY DOORS FACING REGENT STREET. PROPOSED SIGN INCLUDES 3' TALL LETTERS FOR INCREASED VISIBILITY; THE MAXIMUM CODE PERMITTED SIGNAGE IS 2' TALL LETTERS. (QTY 1) REFER TO DETAILED SIGN DRAWINGS ATTACHED FOR MORE INFORMATION.

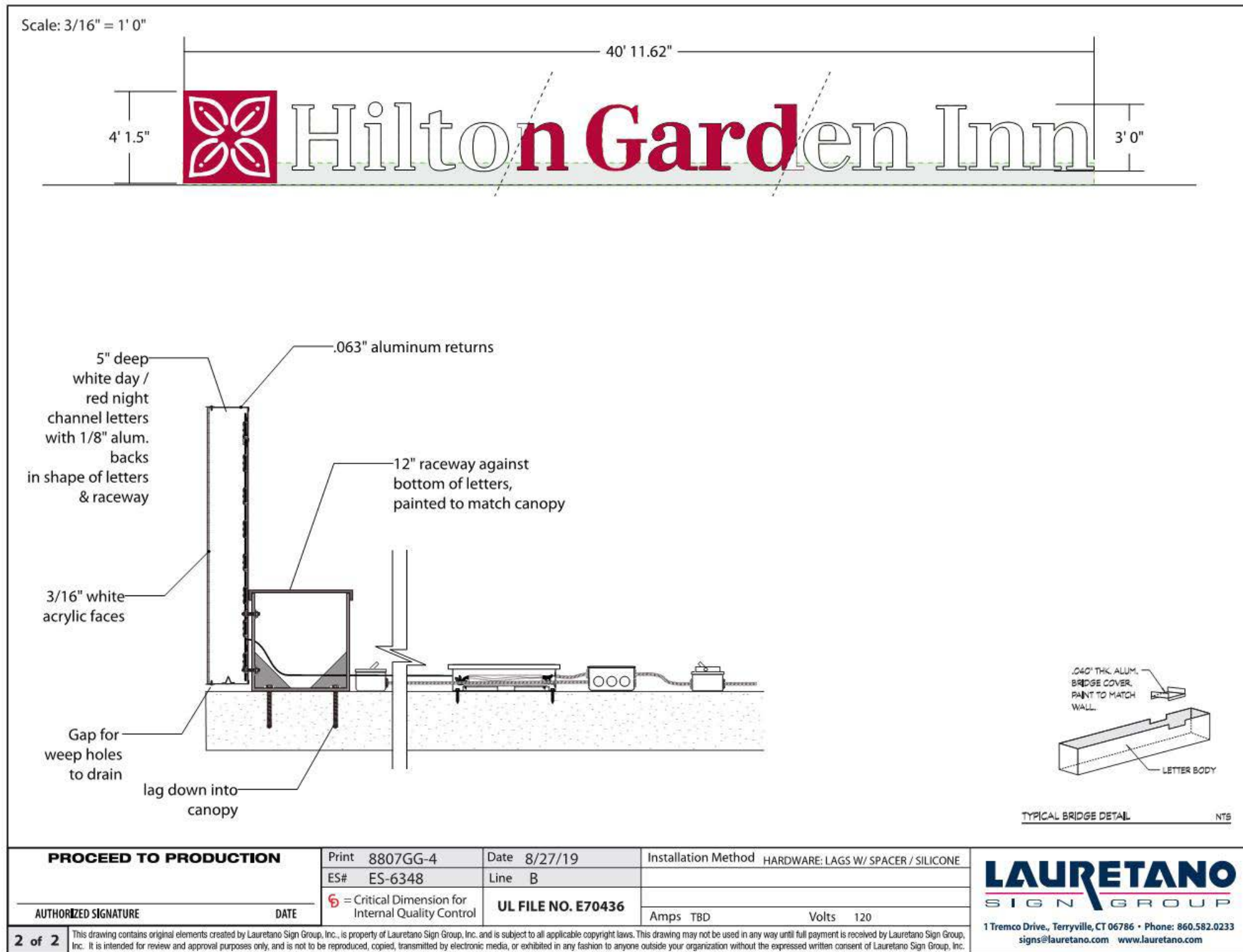

## SIGN TYPES

UDC SIGNAGE CDR SUBMITTAL | 08-28-2019 | PAGE 08

**Kahler Slater**  
COPYRIGHT © 2019 KAHLER SLATER, INC. ALL RIGHTS RESERVED

**C BLADE**

PROJECTING BLADE SIGN LOCATED AT EAST AND WEST ENDS OF BUILDING MOUNTED TO ADDRESS USERS COMING TO HOTEL FROM MULTIPLE DIRECTIONS ON PEDESTRIAN AND VEHICULAR THOROUGHFARES. BOTTOM OF SIGN IS MOUNTED AT 16' ABOVE GRADE AND THE TOP OF THE SIGN DOESN'T PASS THE 3RD FLOOR LINE. PROPOSED SIGN IS ABOUT 44 SF WITH A PERMITTED AREA OF 20 SF PER ZONING. THE INCREASE IN SIZE IS DUE TO VISIBILITY AND LEGIBILITY REASONS. (QTY 2) REFER TO DETAILED SIGN DRAWINGS ATTACHED FOR MORE INFORMATION.

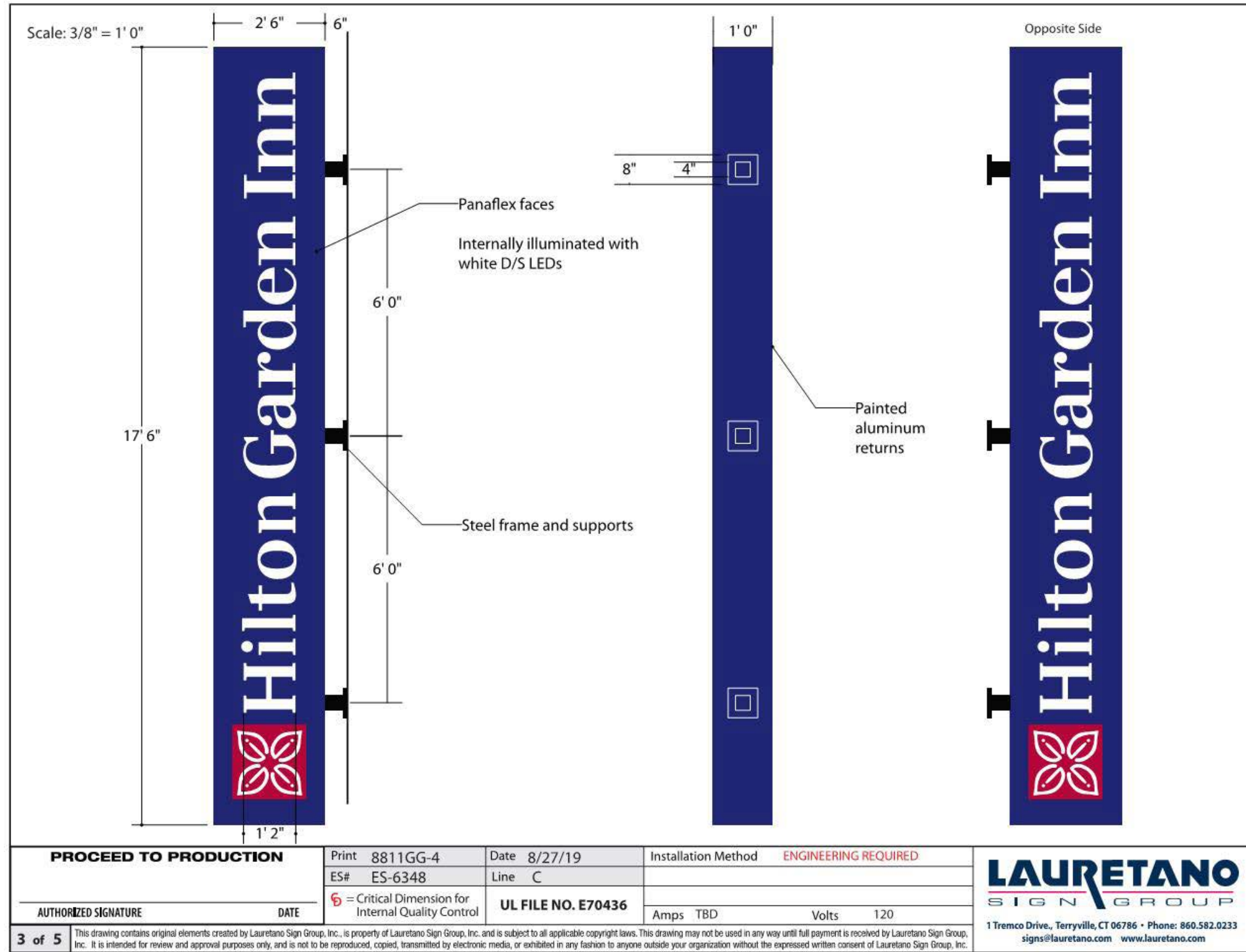

**SIGN TYPES**

# D DIRECTIONAL

DIRECTIONAL ALUMINUM POST AND PANEL SIGN LIMITED TO 3 SF TO MEET ZONING CODE. LOCATED AT NORTHEAST ENTRY BY BIKE TRAIL. (QTY 1) REFER TO DETAILED SIGN DRAWINGS ATTACHED FOR MORE INFORMATION.

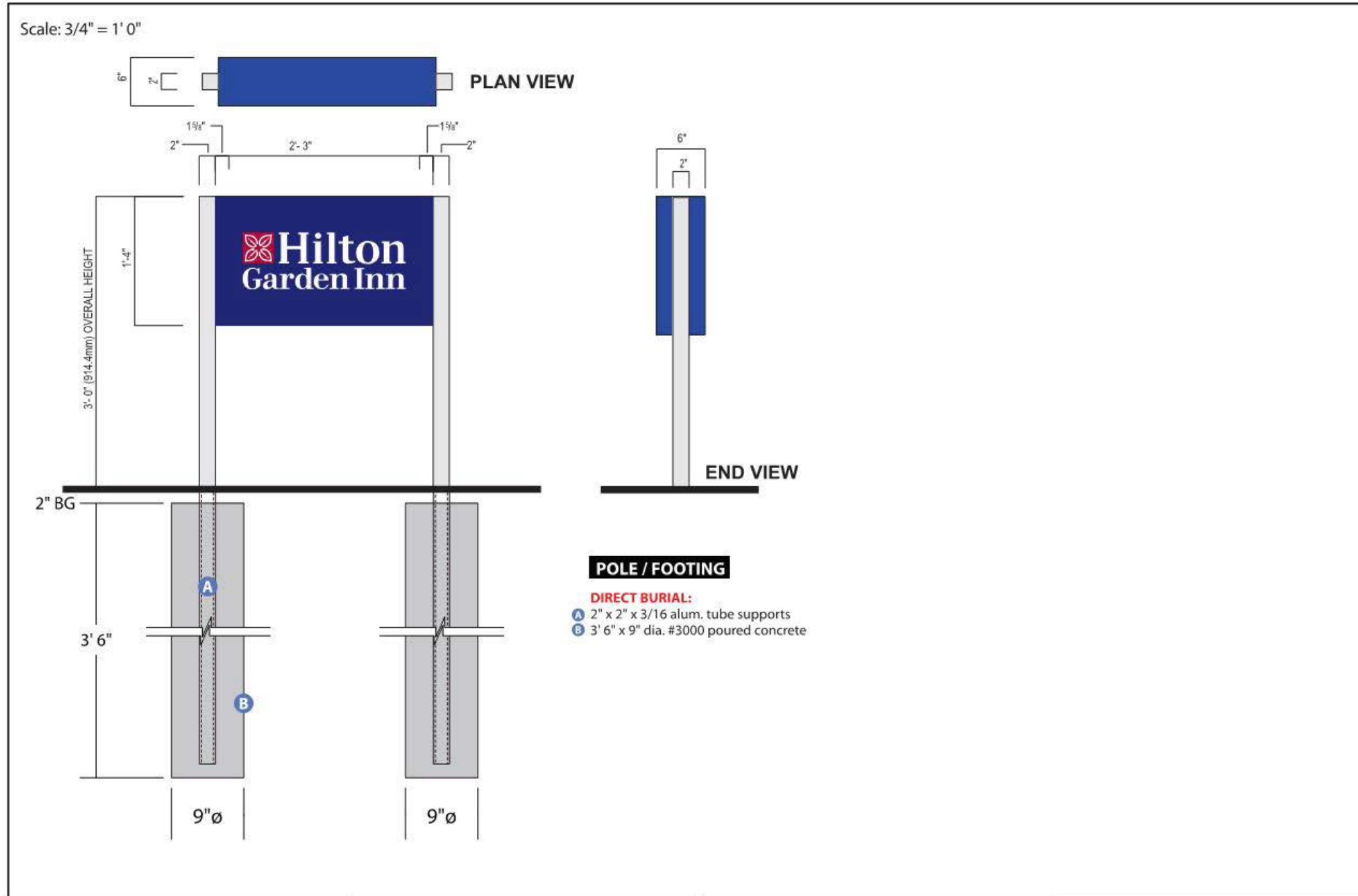

Print 1604GG-3	Date 8/26/19	ES# ES-6348	Line D	SP AC	Sign Type Custom HGI-D-4
<b>CLIENT APPROVAL</b>		Title Hilton Garden Inn	Location Ref. Site Plan		<b>LAURETANO</b> SIGN GROUP 1 Tremco Drive. Terryville, CT 06786 phone: 860.582.0233 fax: 860.583.0949 signs@lauretano.com www.lauretano.com
AUTHORIZED SIGNATURE _____ DATE _____		City/State Madison, WI	Size 1' 5" x 2' 3" (3 sq ft)		
		Customer Hilton Garden Inn	Description OAH: 3' 0"		
		Int. Note	SFNI directional		
1 of 1	This drawing contains original elements created by Lauretano Sign Group, Inc., is property of Lauretano Sign Group, Inc. and is subject to all applicable copyright laws. This drawing may not be used in any way until full payment is received by Lauretano Sign Group, Inc. It is intended for review and approval purposes only, and is not to be reproduced, copied, transmitted by electronic media, or exhibited in any fashion to anyone outside your organization without the expressed written consent of Lauretano Sign Group, Inc.				

## SIGN TYPES



**HILTON GARDEN INN**  
MADISON, WISCONSIN

# E PARKING

CIRCULAR FLAG MOUNTED PARKING ENTRY IDENTIFICATION. PROPOSED SIGN IS 4' IN DIAMETER WITH AN AREA OF ABOUT 12 SF WITH A CODE MAXIMUM PERMITTED AREA OF 3 SF. VISIBILITY OF PARKING ENTRY IS CRITICAL FOR TRANSIENT GUESTS. (QTY 1) REFER TO DETAILED SIGN DRAWINGS ATTACHED FOR MORE INFORMATION.

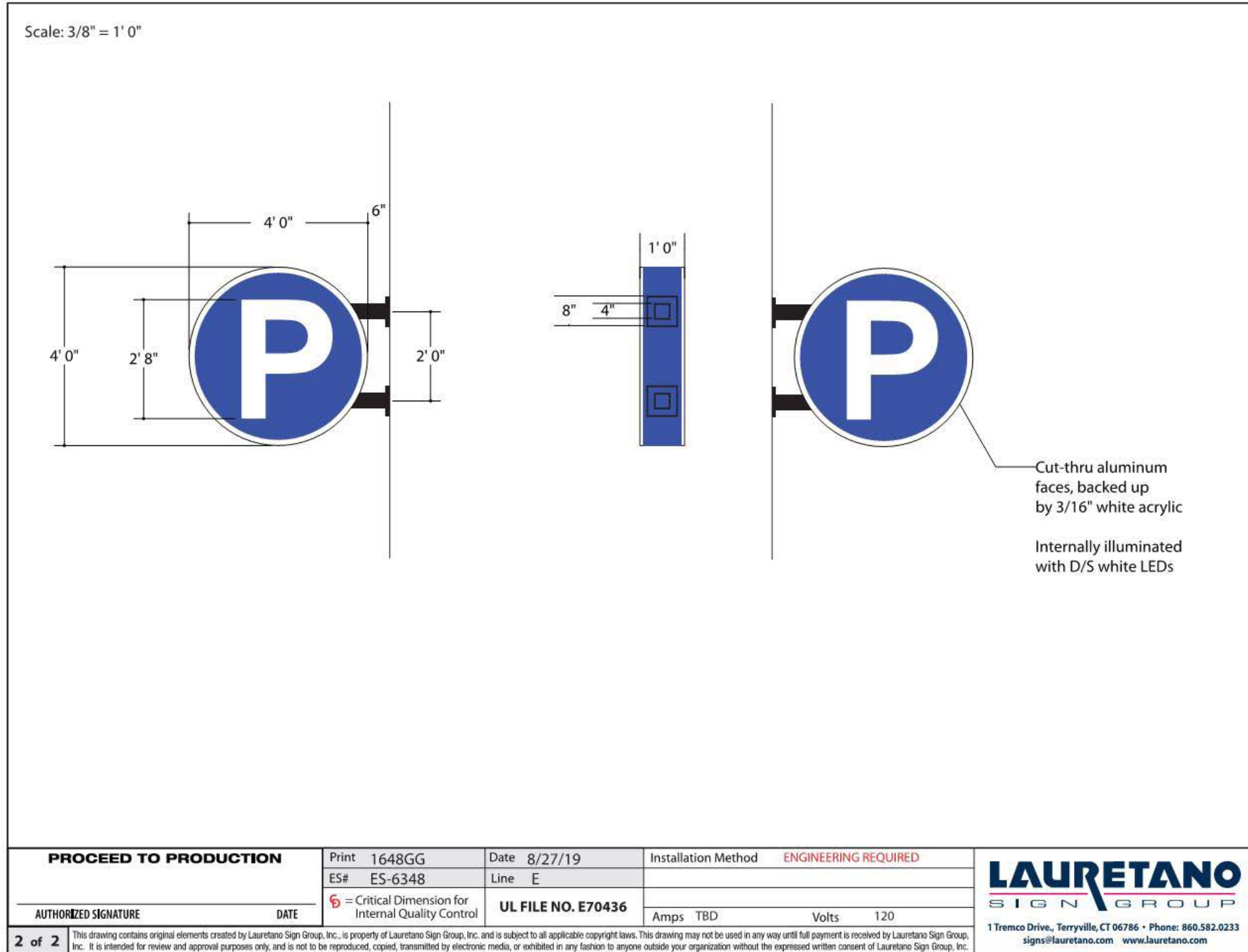

## SIGN TYPES

# F ENTRY PLAQUE

PEDESTRIAN SCALED ENTRY WALL SIGN AT FRONT DOOR. THIS IS AN ADDITIONAL WALL SIGN ON THE SAME FACE, BUT INTENDED FOR PEDESTRIANS NOT APPROACHING VEHICLES. REFER TO DETAILED SIGN DRAWINGS ATTACHED FOR MORE INFORMATION.

Scale: 1" = 1' 0"

\* FABRICATED WALL PLAQUE WITH BLACK PAINT FILLED PHOTO ETCHED LOGO GRAPHICS

**SPECIFICATIONS:**  
 SIGNS ARE CRAFTED FROM SHEET MATERIAL RATHER THAN SOLID PLATE - THIS GREATLY REDUCES WEIGHT AND ALLOWS A GREATER DEPTH TO SIGN.

STAINLESS STEEL IS PREFERRED MATERIAL BECAUSE OF DURABILITY AND COLOR RELATIONSHIP TO OTHER PRODUCTS IN SIGN SYSTEM. FINISH MAY BE POLISHED OR SATIN (LIGHTLY BRUSHED) APPLY CLEAR COAT FINISH TO COMPLETED SIGN.

GRAPHICS ARE PHOTO MECHANICALLY ACID ETCHED AND FILLED WITH BLACK PIGMENT FOR VERY CLEAN, DURABLE AND ACCURATE REPRODUCTION.

MOUNT PLAQUES FLUSH TO WALL WITH NON-CORROSIVE CONCEALED FASTENERS AND ANCHORS - WALL MATERIAL WILL DETERMINE MOUNTING METHODS.

<b>PROCEED TO PRODUCTION</b>	Print 8818GG-3	Date 8/26/19	
	ES# ES-6348	Line F	
AUTHORIZED SIGNATURE _____	DATE _____	6 = Critical Dimension for Internal Quality Control	UL FILE NO. E70436

**LAURETANO SIGN GROUP**  
 1 Tremco Drive, Terryville, CT 06786 • Phone: 860.582.0233  
 signs@lauretano.com www.lauretano.com

2 of 2 This drawing contains original elements created by Lauretano Sign Group, Inc., is property of Lauretano Sign Group, Inc. and is subject to all applicable copyright laws. This drawing may not be used in any way until full payment is received by Lauretano Sign Group, Inc. It is intended for review and approval purposes only, and is not to be reproduced, copied, transmitted by electronic media, or exhibited in any fashion to anyone outside your organization without the expressed written consent of Lauretano Sign Group, Inc.



## SIGN TYPES



PROPOSED SIGN SIZES



MAXIMUM SIGN SIZES PER CODE

**1** REGENT STREET ENTRY APPROACH VIEW

C



PROPOSED SIGN SIZE

C



MAXIMUM SIGN SIZE PER CODE

**2 EAST CAMPUS MALL FROM REGENT STREET**





**3 MAIN ENTRY APPROACH DETAIL**

UDC SIGNAGE CDR SUBMITTAL | 08-28-2019 | PAGE 15



C

D

**4** VIEW FROM NORTHEAST AT BIKE TRAIL

UDC SIGNAGE CDR SUBMITTAL | 08-28-2019 | PAGE 16



## NIGHT VIEW OF SIGNS

UDC SIGNAGE CDR SUBMITTAL | 08-28-2019 | PAGE 17

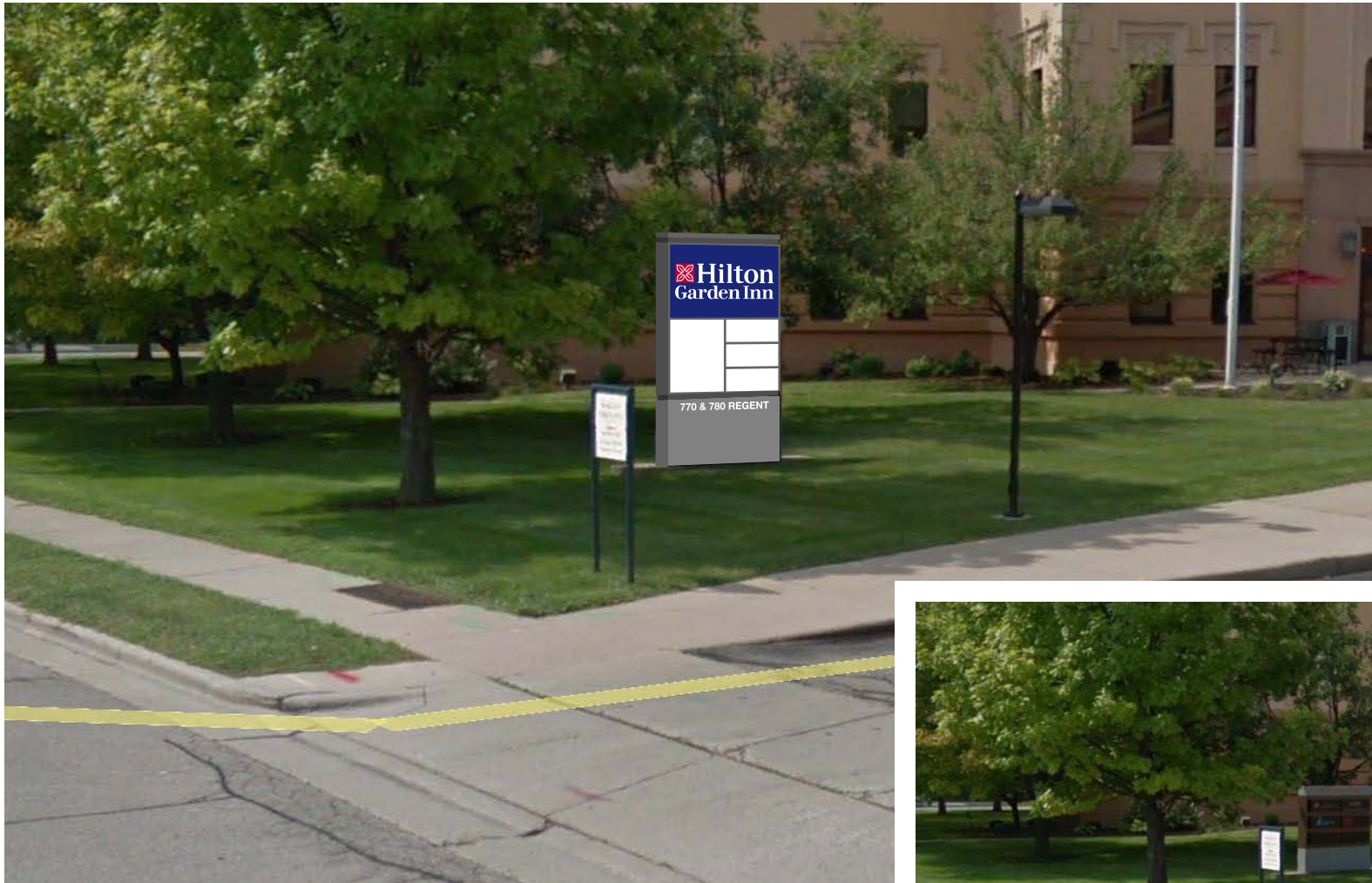



Print 8828GG-4	Date 8/27/19	ES# ES-6348	Line A	SP AC	Sign Type	DFI Monument with 4 tenants
<b>CLIENT APPROVAL</b>		Title	Hilton Garden Inn		Size	(1) 2' 5.75" x 3' 10" (9.5 sq ft)
		City/State	Madison, WI		OAH 7' 11.5"	(1) 2' 5.75" x 1' 10.5" (4.64 sq ft)
AUTHORIZED SIGNATURE		Customer	Hilton Garden Inn			(3) 9.25" x 1' 10.5" (1.44 sq ft each)
		Int. Note			Description	Cut-thru/backed-up
DATE						

**LAURETANO**  
SIGN GROUP

1 Tremco Drive. Terryville, CT 06786  
phone: 860.582.0233 fax: 860.583.0949  
signs@lauretano.com www.lauretano.com

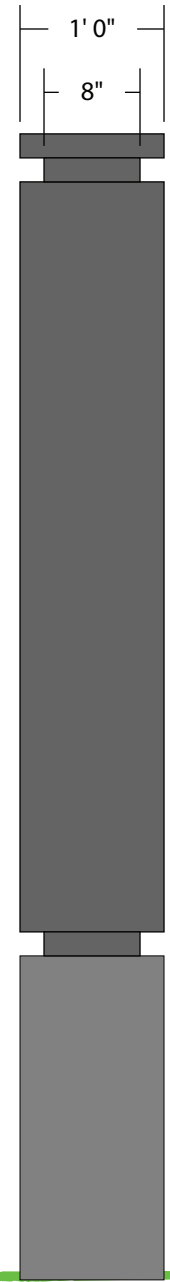
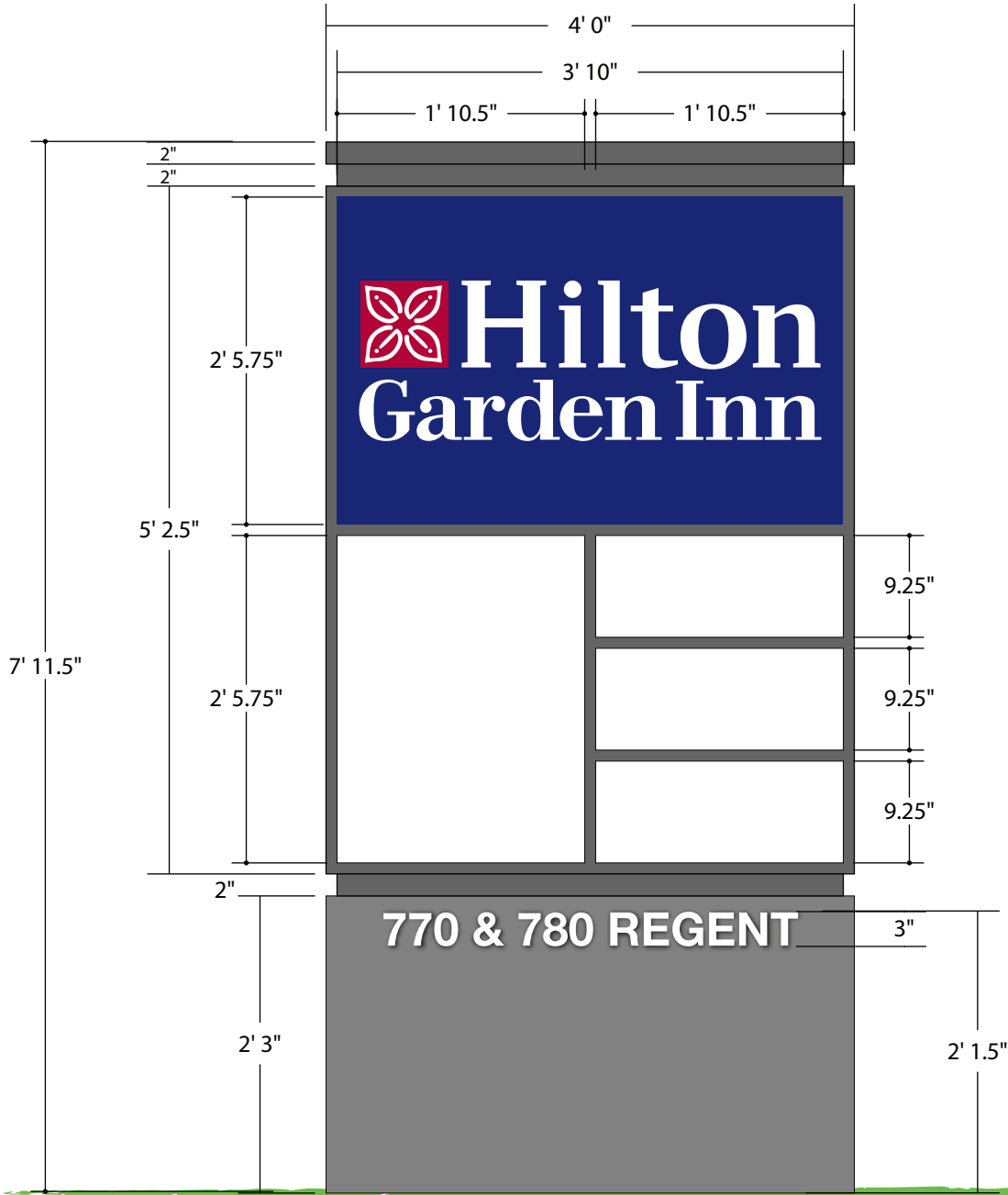
Scale: 3/4" = 1' 0"



<b>PROCEED TO PRODUCTION</b>	Print 8828GG-4	Date 8/27/19	20.83 sq ft total	
	ES# ES-6348	Line A		
AUTHORIZED SIGNATURE _____	DATE _____	 = Critical Dimension for Internal Quality Control	<b>UL FILE NO. E70436</b>	
			Amps TBD	Volts 120
<b>2 of 3</b>	This drawing contains original elements created by Lauretano Sign Group, Inc., is property of Lauretano Sign Group, Inc. and is subject to all applicable copyright laws. This drawing may not be used in any way until full payment is received by Lauretano Sign Group, Inc. It is intended for review and approval purposes only, and is not to be reproduced, copied, transmitted by electronic media, or exhibited in any fashion to anyone outside your organization without the expressed written consent of Lauretano Sign Group, Inc.			

**LAURETANO**  
SIGN GROUP

1 Tremco Drive., Terryville, CT 06786 • Phone: 860.582.0233  
signs@lauretano.com www.lauretano.com

Scale: 3/8" = 1' 0"

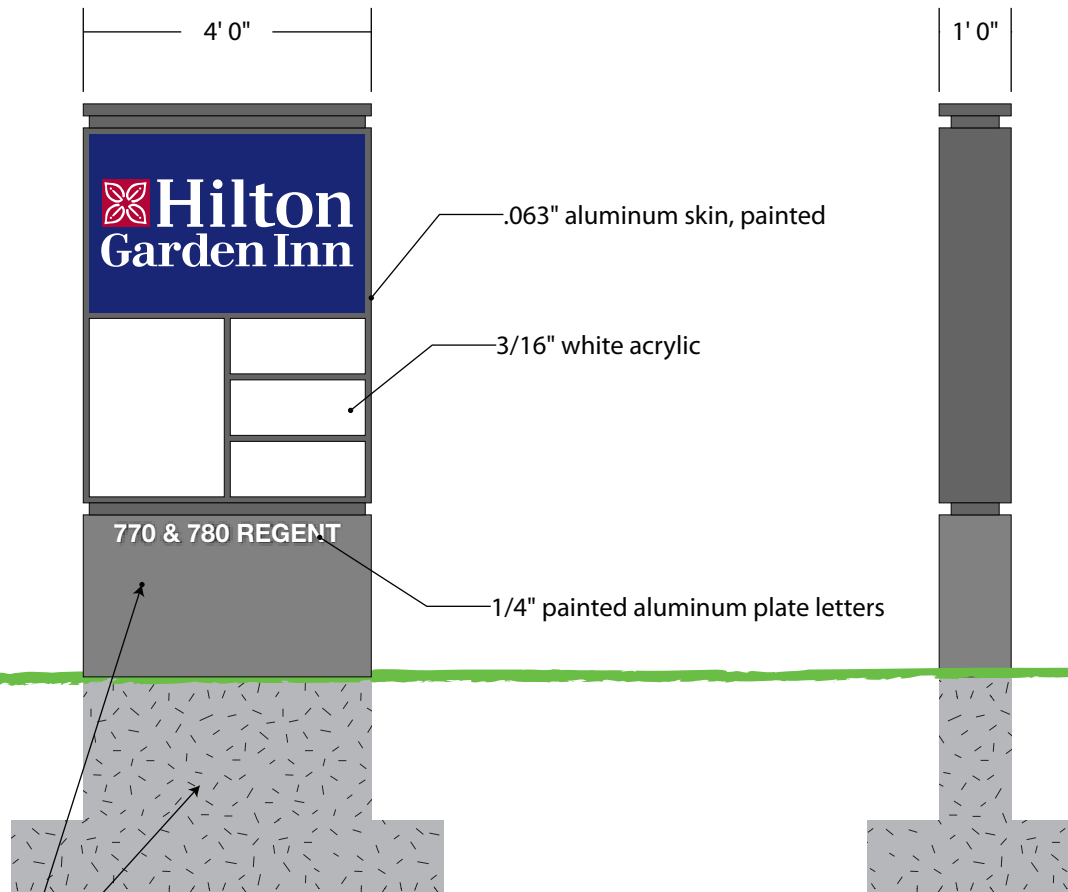

Acid etched gray  
pre-cast concrete  
base configuration  
by others

<b>PROCEED TO PRODUCTION</b>	Print 8828GG-4	Date 8/27/19	
	ES# ES-6348	Line A	
AUTHORIZED SIGNATURE _____	DATE _____	UL FILE NO. E70436	

**LAURETANO**  
SIGN GROUP

1 Tremco Drive., Terryville, CT 06786 • Phone: 860.582.0233  
signs@lauretano.com www.lauretano.com

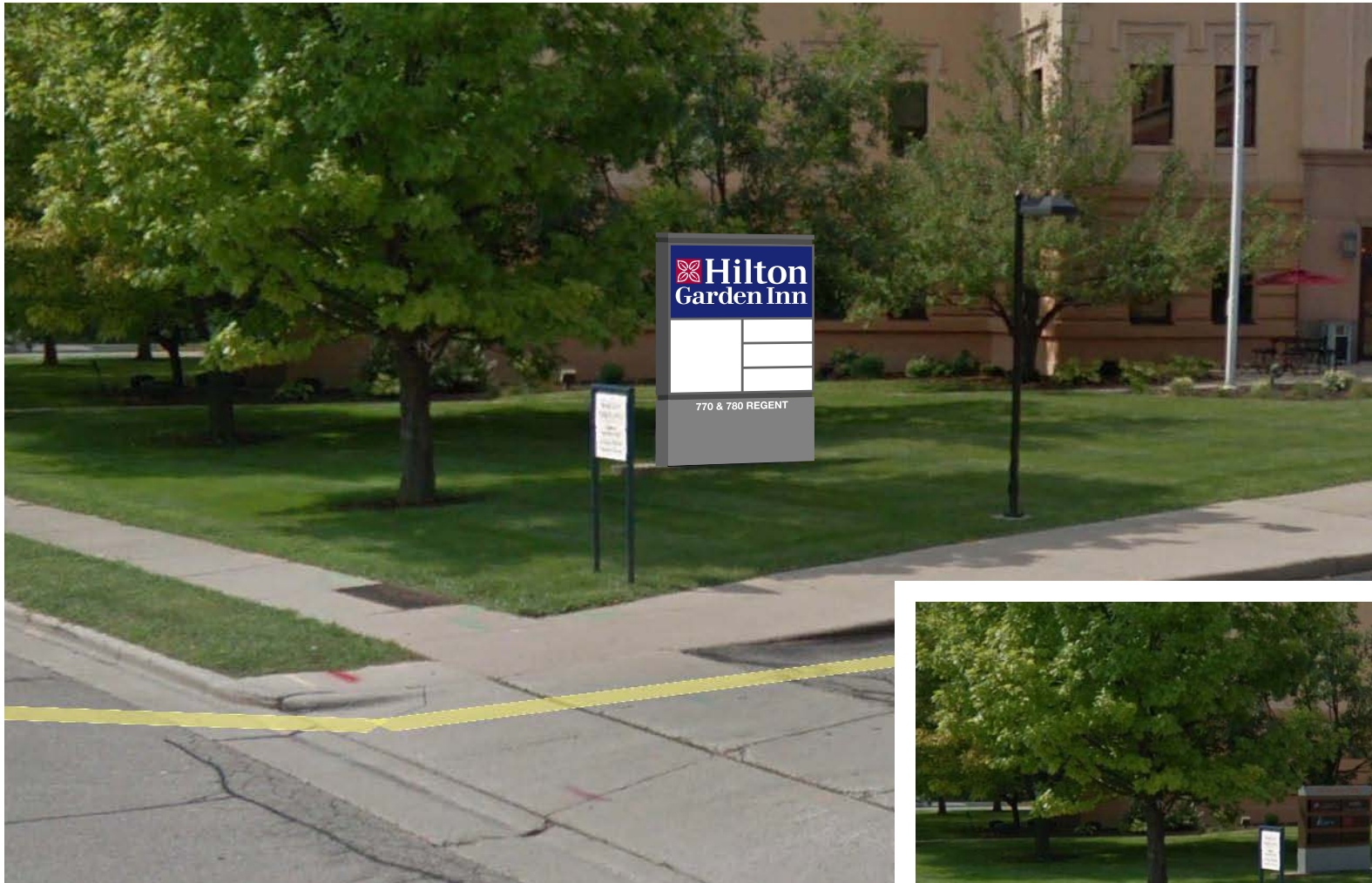

Print 1645GG	Date 8/27/19	ES# ES-6348	Line A	SP AC	Sign Type	DFI Monument with 4 tenants
<b>CLIENT APPROVAL</b>		Title	Hilton Garden Inn		Size	(1) 2' 5.75" x 4' 10" (11.98 sq ft)
		City/State	Madison, WI		OAH 7' 11.5"	(1) 2' 5.75" x 2' 4.5" (5.88 sq ft)
AUTHORIZED SIGNATURE		Customer	Hilton Garden Inn			(3) 9.25" x 2' 4.5" (1.83 sq ft each)
		Int. Note			Description	Cut-thru/push-thru details
DATE						

**LAURETANO**  
SIGN GROUP

1 Tremco Drive. Terryville, CT 06786  
phone: 860.582.0233 fax: 860.583.0949  
signs@lauretano.com www.lauretano.com

Scale: 3/4" = 1' 0"

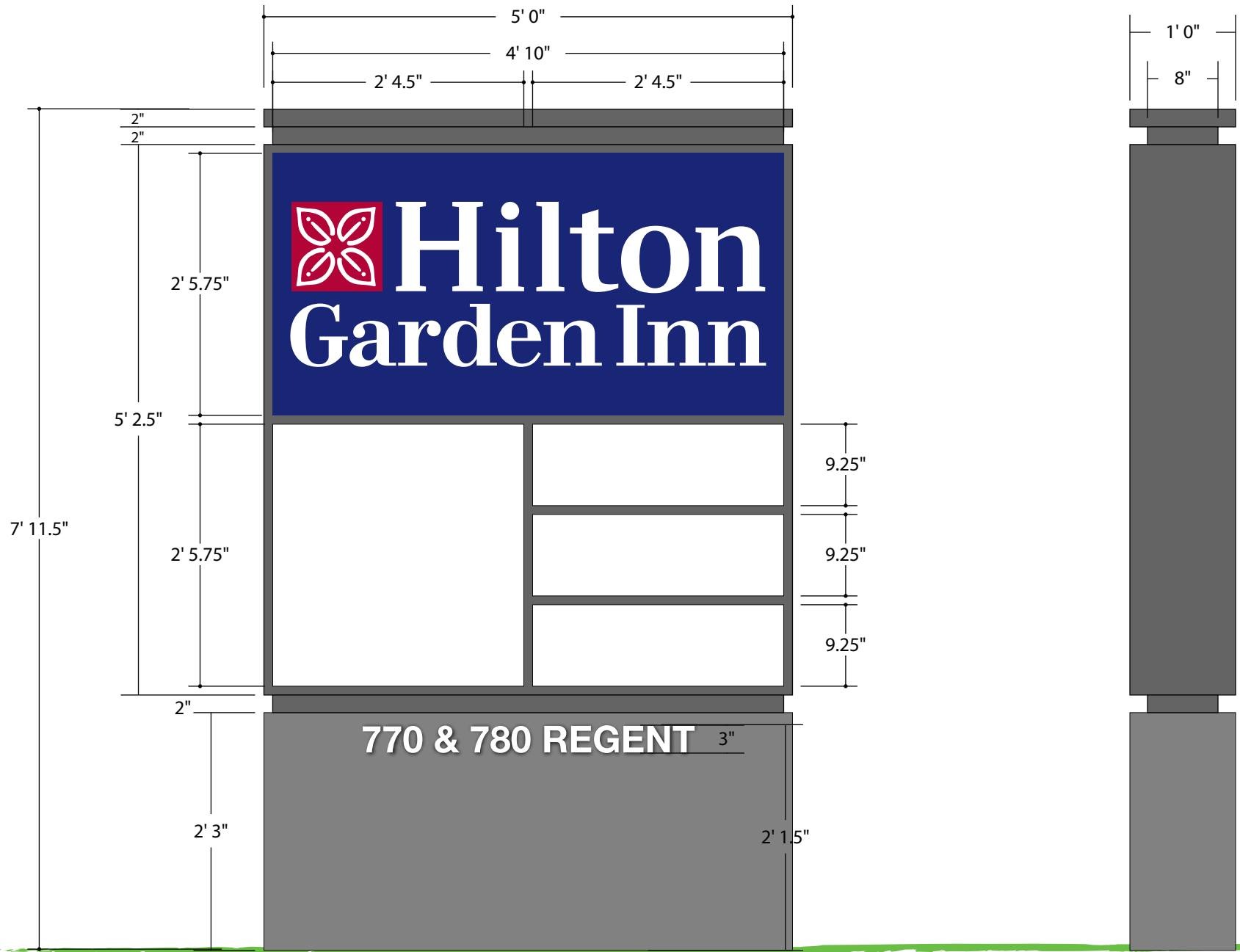

<b>PROCEED TO PRODUCTION</b>	Print 1645GG	Date 8/27/19	26 sq ft total		
	ES# ES-6348	Line A			
AUTHORIZED SIGNATURE _____	DATE _____	Ⓢ = Critical Dimension for Internal Quality Control	<b>UL FILE NO. E70436</b>	Amps TBD	Volts 120
<b>2 of 3</b>	This drawing contains original elements created by Lauretano Sign Group, Inc., is property of Lauretano Sign Group, Inc. and is subject to all applicable copyright laws. This drawing may not be used in any way until full payment is received by Lauretano Sign Group, Inc. It is intended for review and approval purposes only, and is not to be reproduced, copied, transmitted by electronic media, or exhibited in any fashion to anyone outside your organization without the expressed written consent of Lauretano Sign Group, Inc.				

**LAURETANO**  
SIGN GROUP

1 Tremco Drive., Terryville, CT 06786 • Phone: 860.582.0233  
signs@lauretano.com www.lauretano.com



Scale: 3/8" = 1' 0"

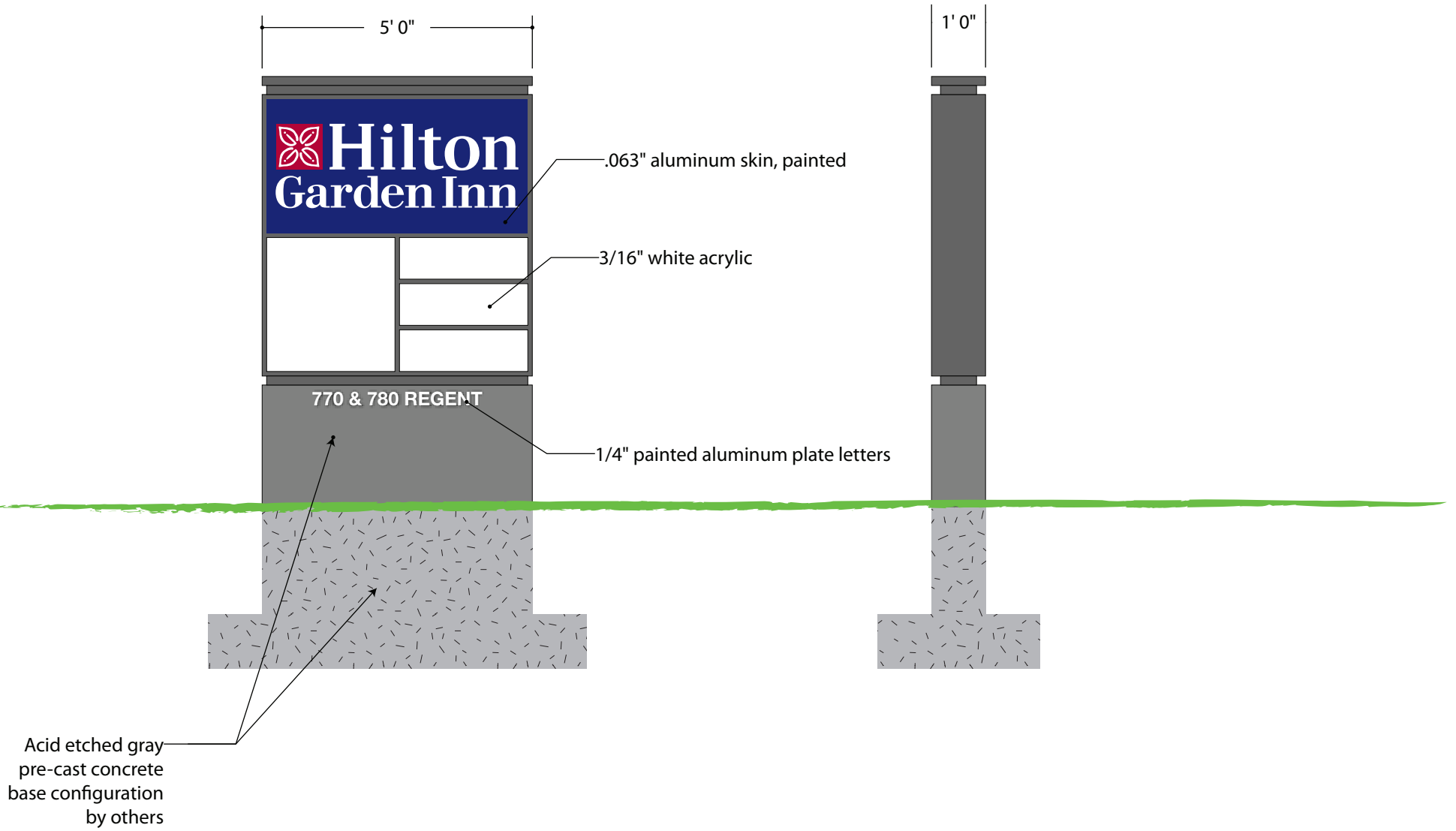

<b>PROCEED TO PRODUCTION</b>	Print 1645GG	Date 8/27/19	
	ES# ES-6348	Line A	
AUTHORIZED SIGNATURE _____	DATE _____	 = Critical Dimension for Internal Quality Control	<b>UL FILE NO. E70436</b>
<b>3 of 3</b>	<small>This drawing contains original elements created by Lauretano Sign Group, Inc., is property of Lauretano Sign Group, Inc. and is subject to all applicable copyright laws. This drawing may not be used in any way until full payment is received by Lauretano Sign Group, Inc. It is intended for review and approval purposes only, and is not to be reproduced, copied, transmitted by electronic media, or exhibited in any fashion to anyone outside your organization without the expressed written consent of Lauretano Sign Group, Inc.</small>		<b>LAURETANO</b> SIGN GROUP <small>1 Tremco Drive., Terryville, CT 06786 • Phone: 860.582.0233          signs@lauretano.com www.lauretano.com</small>



**SOUTH ELEVATION**  
**SCALE: 1/16" = 1' 0"**  
**FRONTAGE: 323' 0"**

Print 8807GG-4	Date 8/27/19	ES# ES-6348	Line B	SP AC	Sign Type HGI-ICLL-36L-WR
<b>CLIENT APPROVAL</b>		Title Hilton Garden Inn			Location South Elevation
		City/State Madison, WI			Size 4' 1.5" x 40' 3.6" (169 sq ft)
AUTHORIZED SIGNATURE _____ DATE _____		Customer Hilton Garden Inn			Description White day / red night LED
		Int. Note			Channel letterset



1 Tremco Drive. Terryville, CT 06786  
 phone: 860.582.0233 fax: 860.583.0949  
 signs@lauretano.com www.lauretano.com

Scale: 3/16" = 1' 0"

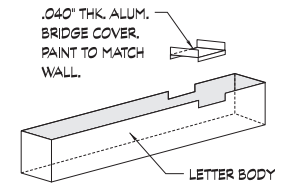
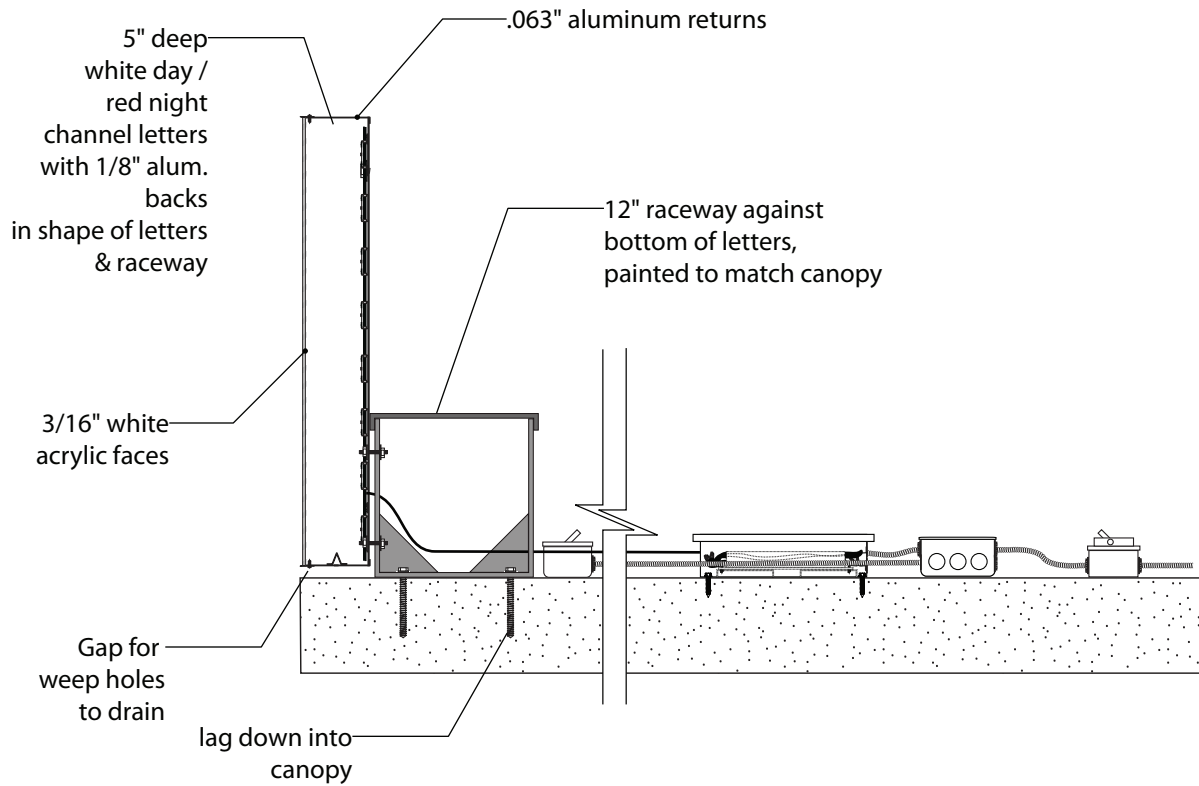
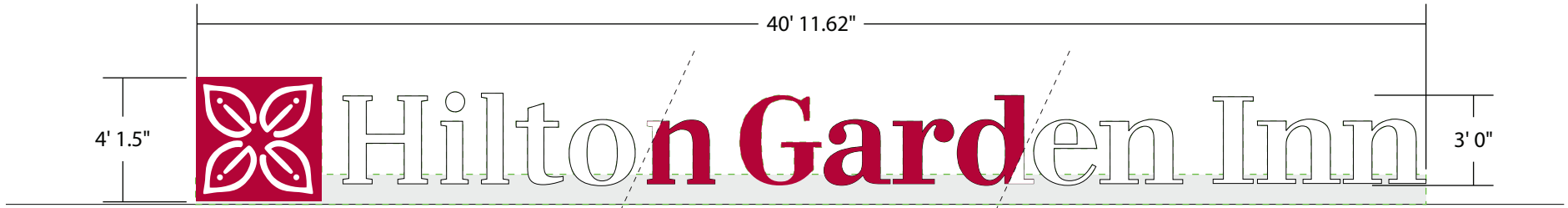

TYPICAL BRIDGE DETAIL NTS

<b>PROCEED TO PRODUCTION</b>	Print 8807GG-4	Date 8/27/19	Installation Method	HARDWARE: LAGS W/ SPACER / SILICONE
	ES# ES-6348	Line B		
AUTHORIZED SIGNATURE _____	DATE _____	Ⓢ = Critical Dimension for Internal Quality Control	<b>UL FILE NO. E70436</b>	Amps TBD
				Volts 120

**LAURETANO**  
SIGN GROUP

1 Tremco Drive., Terryville, CT 06786 • Phone: 860.582.0233  
signs@lauretano.com www.lauretano.com



**SOUTH ELEVATION**  
**SCALE: 1/16" = 1' 0"**  
**FRONTAGE: 323' 0"**

Print 1646GG	Date 8/27/19	ES# ES-6348	Line B	SP AC	Sign Type HGI-ICLL-24L-WR
<b>CLIENT APPROVAL</b>		Title Hilton Garden Inn			Location South Elevation
		City/State Madison, WI			Size 2' 9.86" x 28' 0.34" (79.08 sq ft)
AUTHORIZED SIGNATURE _____ DATE _____		Customer Hilton Garden Inn			Description White day / red night LED
		Int. Note			Channel letterset



**1 Tremco Drive. Terryville, CT 06786**  
**phone: 860.582.0233 fax: 860.583.0949**  
**signs@lauretano.com www.lauretano.com**

Scale: 3/16" = 1' 0"

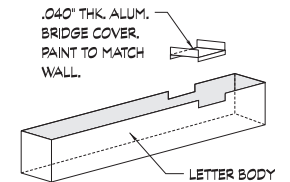
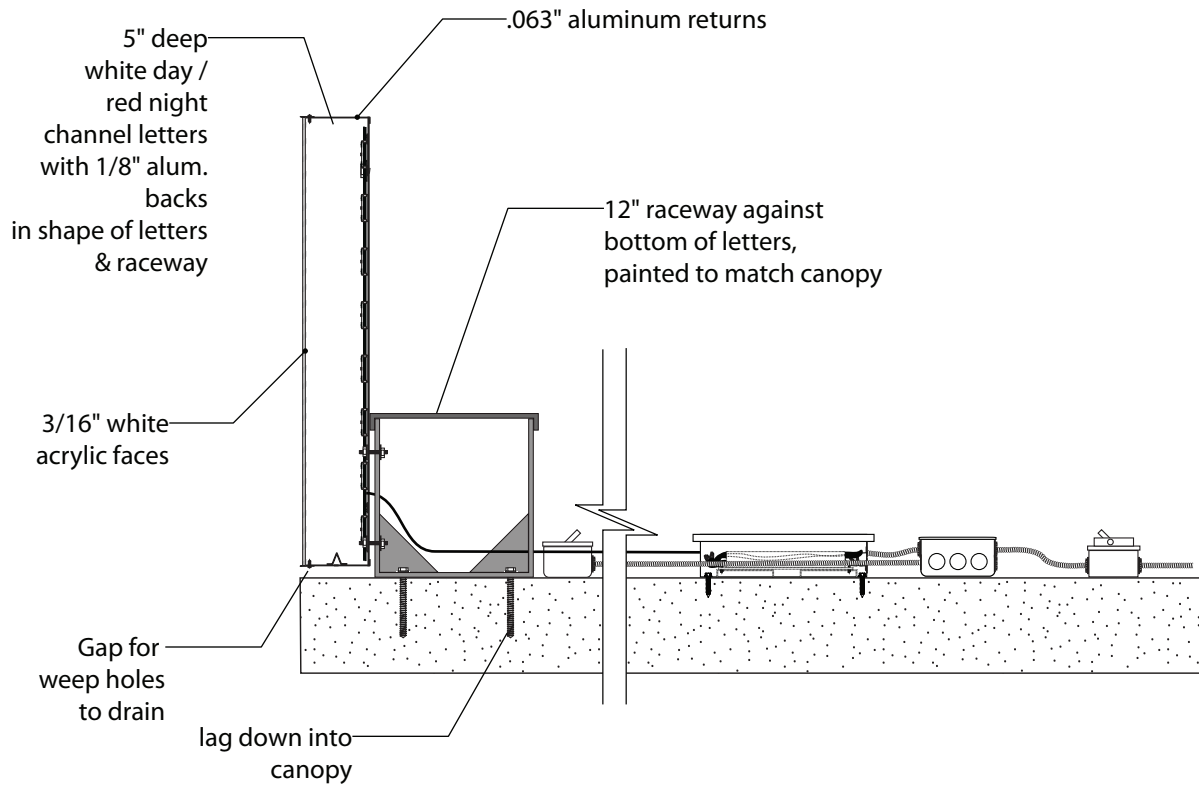
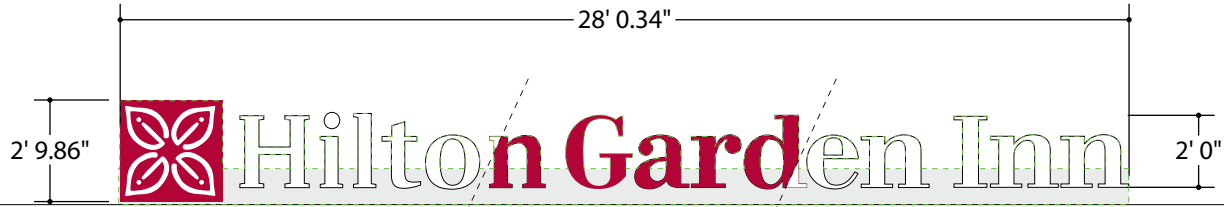

TYPICAL BRIDGE DETAIL NTS

<b>PROCEED TO PRODUCTION</b>	Print 1646GG	Date 8/27/19	Installation Method	HARDWARE: LAGS W/ SPACER / SILICONE
	ES# ES-6348	Line B		
AUTHORIZED SIGNATURE _____	DATE _____	 = Critical Dimension for Internal Quality Control	<b>UL FILE NO. E70436</b>	
			Amps TBD	Volts 120

**LAURETANO**  
SIGN GROUP

1 Tremco Drive., Terryville, CT 06786 • Phone: 860.582.0233  
signs@lauretano.com www.lauretano.com



**SOUTH ELEVATION**  
**SCALE: 1/16" = 1' 0"**  
**FRONTAGE: 323' 0"**

Print 8811GG-4	Date 8/27/19	ES# ES-6348	Line C	SP AC	Sign Type	Blade Sign
<b>CLIENT APPROVAL</b>		Title	Hilton Garden Inn		Location	East & West Elevations
		City/State	Madison, WI		Size	2' 6" x 17' 6" (43.75 sq ft)
AUTHORIZED SIGNATURE _____ DATE _____		Customer	Hilton Garden Inn		Description	DFI vertical sign with cut-thru faces
		Int. Note				

**LAURETANO**  
 SIGN GROUP

1 Tremco Drive. Terryville, CT 06786  
 phone: 860.582.0233 fax: 860.583.0949  
 signs@lauretano.com www.lauretano.com

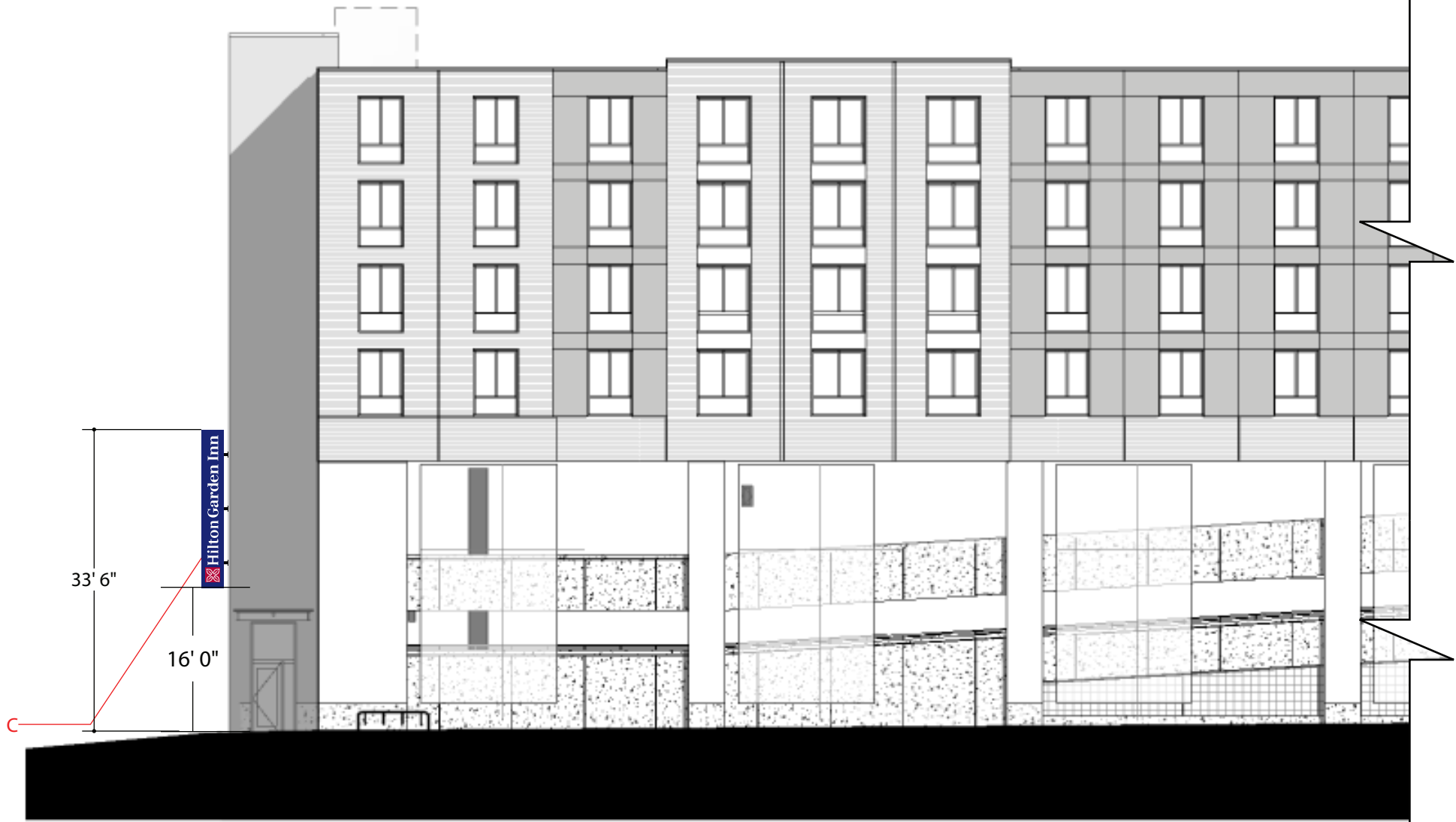

**SOUTH ELEVATION**  
**SCALE: 1/16" = 1' 0"**  
**FRONTAGE: 323' 0"**

<b>PROCEED TO PRODUCTION</b>	Print 8811GG-4	Date 8/27/19	Installation Method <b>ENGINEERING REQUIRED</b>
	ES# ES-6348	Line C	
AUTHORIZED SIGNATURE _____	Ⓢ = Critical Dimension for Internal Quality Control	<b>UL FILE NO. E70436</b>	Amps TBD
DATE _____			Volts 120

**LAURETANO**  
 SIGN GROUP

1 Tremco Drive., Terryville, CT 06786 • Phone: 860.582.0233  
 signs@lauretano.com www.lauretano.com

Scale: 3/8" = 1' 0"

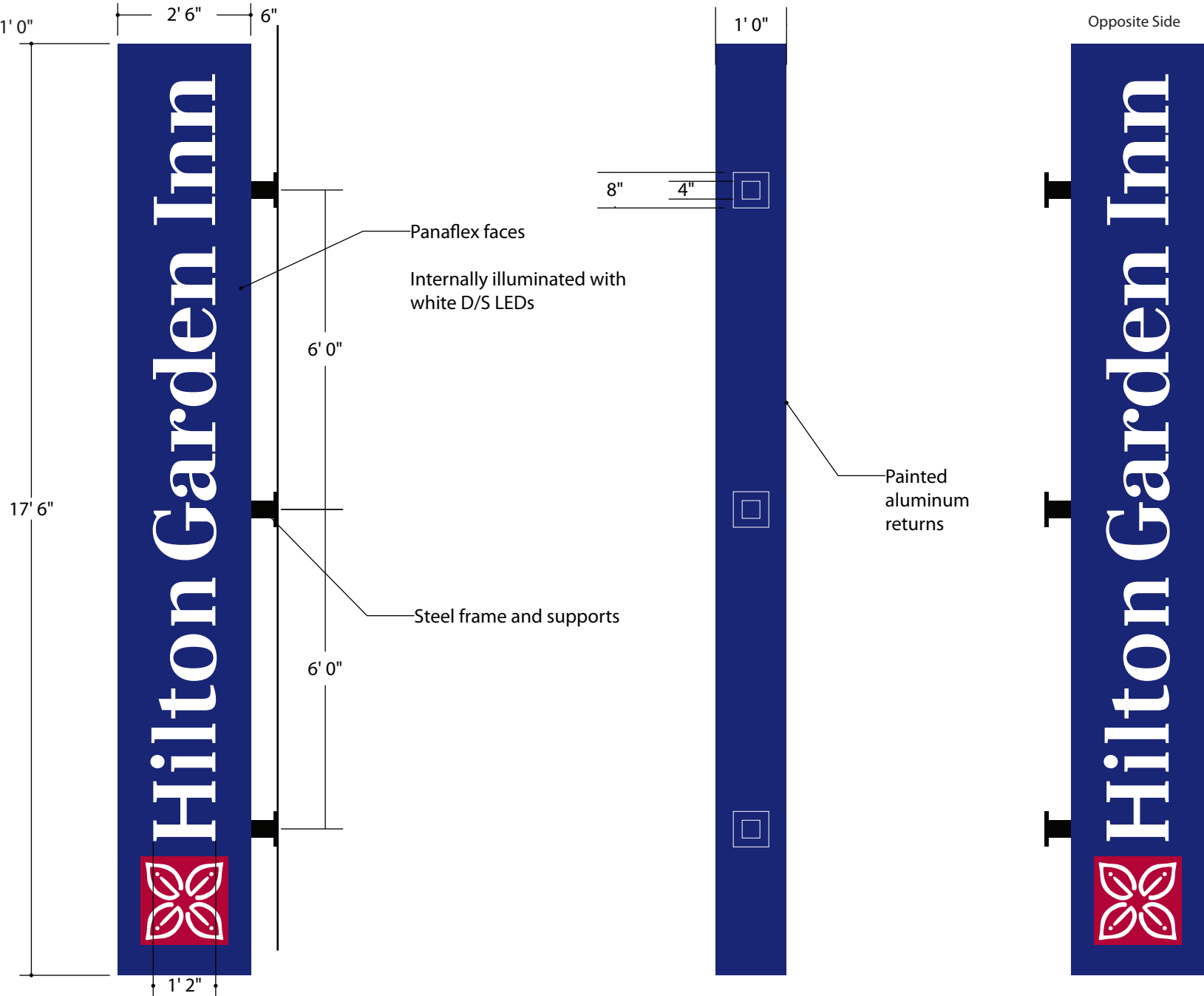

**PROCEED TO PRODUCTION**

Print 8811GG-4

Date 8/27/19

Installation Method **ENGINEERING REQUIRED**

ES# ES-6348

Line C

 = Critical Dimension for Internal Quality Control

**UL FILE NO. E70436**

Amps TBD

Volts 120

AUTHORIZED SIGNATURE \_\_\_\_\_

DATE \_\_\_\_\_

**LAURETANO**  
SIGN GROUP

1 Tremco Drive., Terryville, CT 06786 • Phone: 860.582.0233  
signs@lauretano.com www.lauretano.com



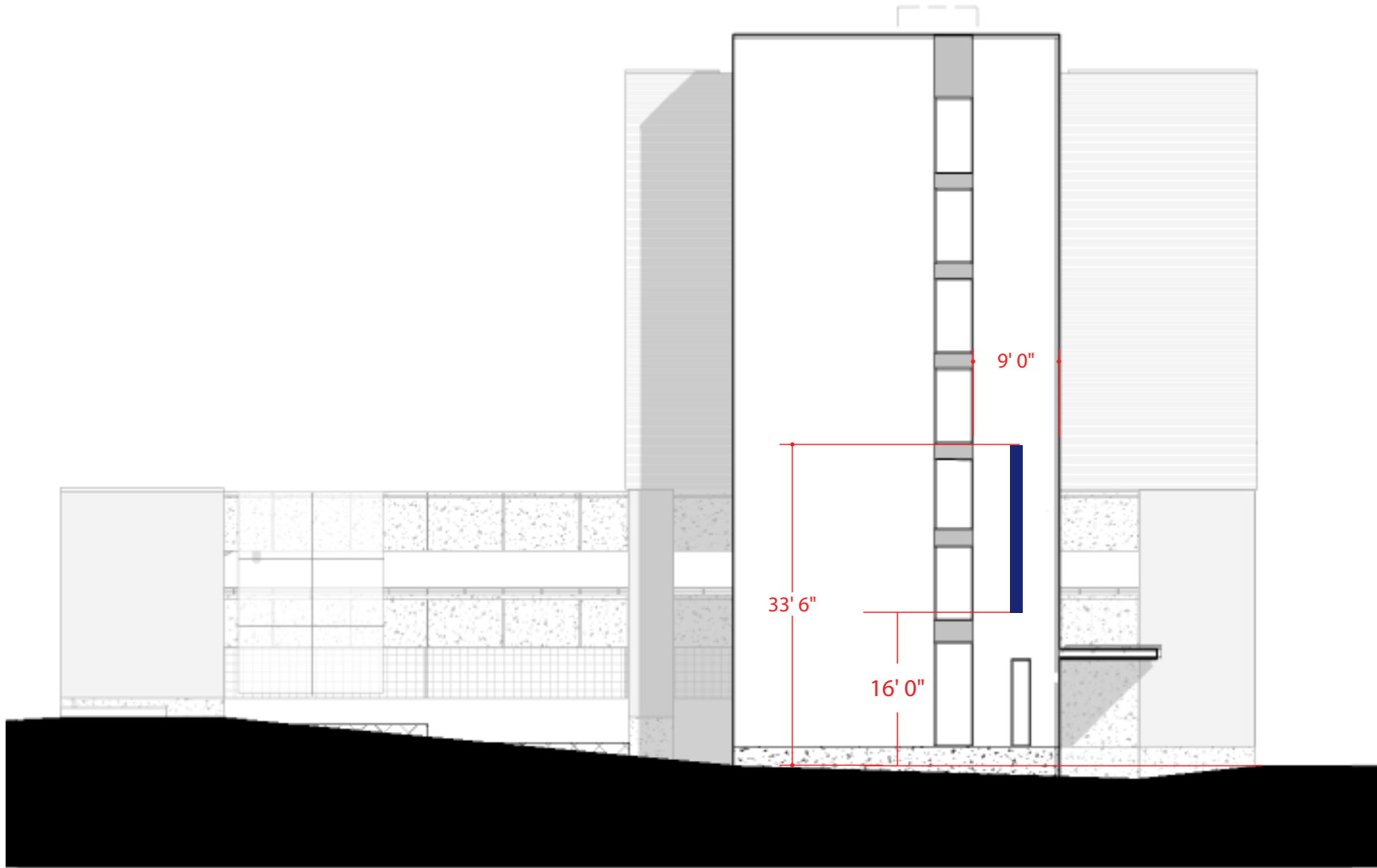

**WEST ELEVATION**  
**SCALE: 1/16" = 1' 0"**  
**FRONTAGE: 124' 6"**

<b>PROCEED TO PRODUCTION</b>	Print 8811GG-4	Date 8/27/19
	ES# ES-6348	Line C
AUTHORIZED SIGNATURE _____	DATE _____	6 = Critical Dimension for Internal Quality Control <b>UL FILE NO. E70436</b>



1 Tremco Drive., Terryville, CT 06786 • Phone: 860.582.0233  
 signs@lauretano.com www.lauretano.com

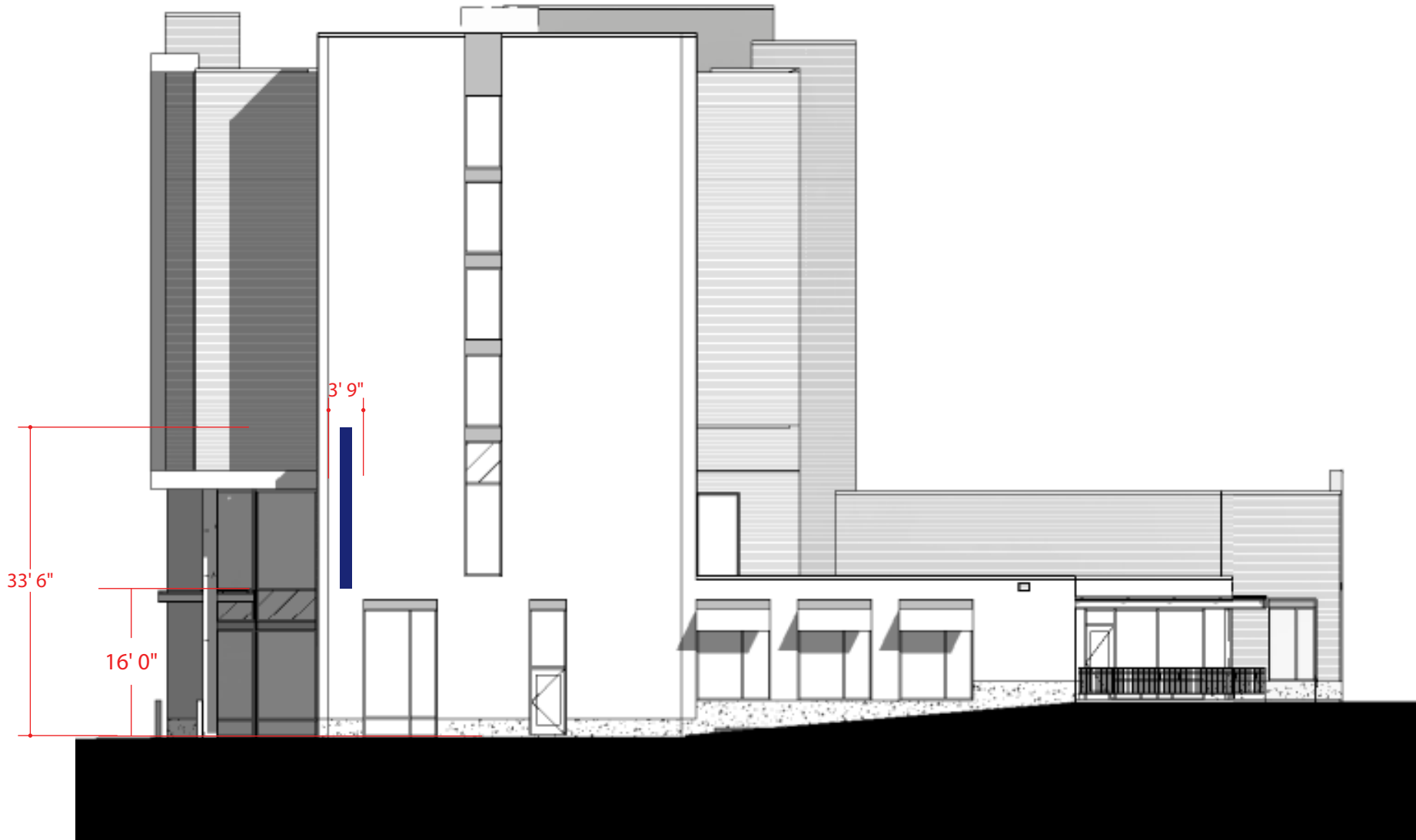

**EAST ELEVATION**  
**SCALE: 1/16" = 1' 0"**  
**FRONTAGE: 129' 0"**

<b>PROCEED TO PRODUCTION</b>	Print 8811GG-4	Date 8/27/19
	ES# ES-6348	Line C
AUTHORIZED SIGNATURE _____	DATE _____	Ⓢ = Critical Dimension for Internal Quality Control <b>UL FILE NO. E70436</b>



1 Tremco Drive., Terryville, CT 06786 • Phone: 860.582.0233  
 signs@lauretano.com www.lauretano.com



**SOUTH ELEVATION**  
**SCALE: 1/16" = 1' 0"**  
**FRONTAGE: 323' 0"**

Print 1647GG	Date 8/27/19	ES# ES-6348	Line C	SP AC	Sign Type	Blade Sign
<b>CLIENT APPROVAL</b>		Title	Hilton Garden Inn		Location	East & West Elevations
		City/State	Madison, WI		Size	1' 8" x 12' 0" (20 sq ft)
AUTHORIZED SIGNATURE _____ DATE _____		Customer	Hilton Garden Inn		Description	DFI vertical sign with cut-thru faces
		Int. Note				



**1 Tremco Drive. Terryville, CT 06786**  
**phone: 860.582.0233 fax: 860.583.0949**  
**signs@lauretano.com www.lauretano.com**



**SOUTH ELEVATION**  
**SCALE: 1/16" = 1' 0"**  
**FRONTAGE: 323' 0"**

<b>PROCEED TO PRODUCTION</b>	Print 1647GG	Date 8/27/19	ENGINEERING REQUIRED		
	ES# ES-6348	Line C			
AUTHORIZED SIGNATURE _____	DATE _____	 = Critical Dimension for Internal Quality Control	<b>UL FILE NO. E70436</b>	TBD	120

**LAURETANO**  
 SIGN GROUP

1 Tremco Drive., Terryville, CT 06786 • Phone: 860.582.0233  
 signs@lauretano.com www.lauretano.com

Scale: 3/8" = 1' 0"

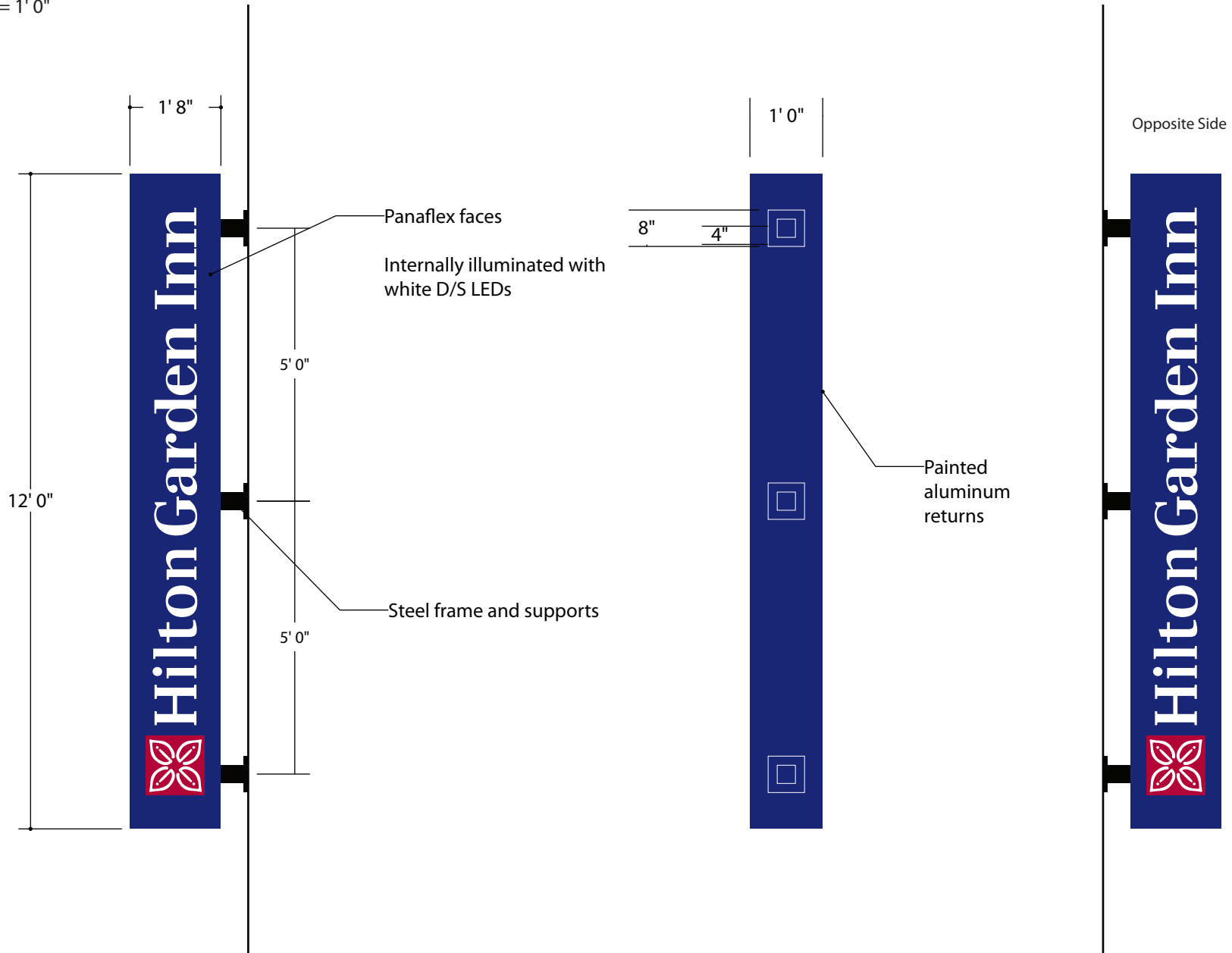

<b>PROCEED TO PRODUCTION</b>	Print 1647GG	Date 8/27/19	Installation Method <b>ENGINEERING REQUIRED</b>
	ES# ES-6348	Line C	
AUTHORIZED SIGNATURE _____	= Critical Dimension for Internal Quality Control	<b>UL FILE NO. E70436</b>	Amps TBD
DATE _____			Volts 120

**LAURETANO**  
SIGN GROUP

1 Tremco Drive., Terryville, CT 06786 • Phone: 860.582.0233  
signs@lauretano.com www.lauretano.com

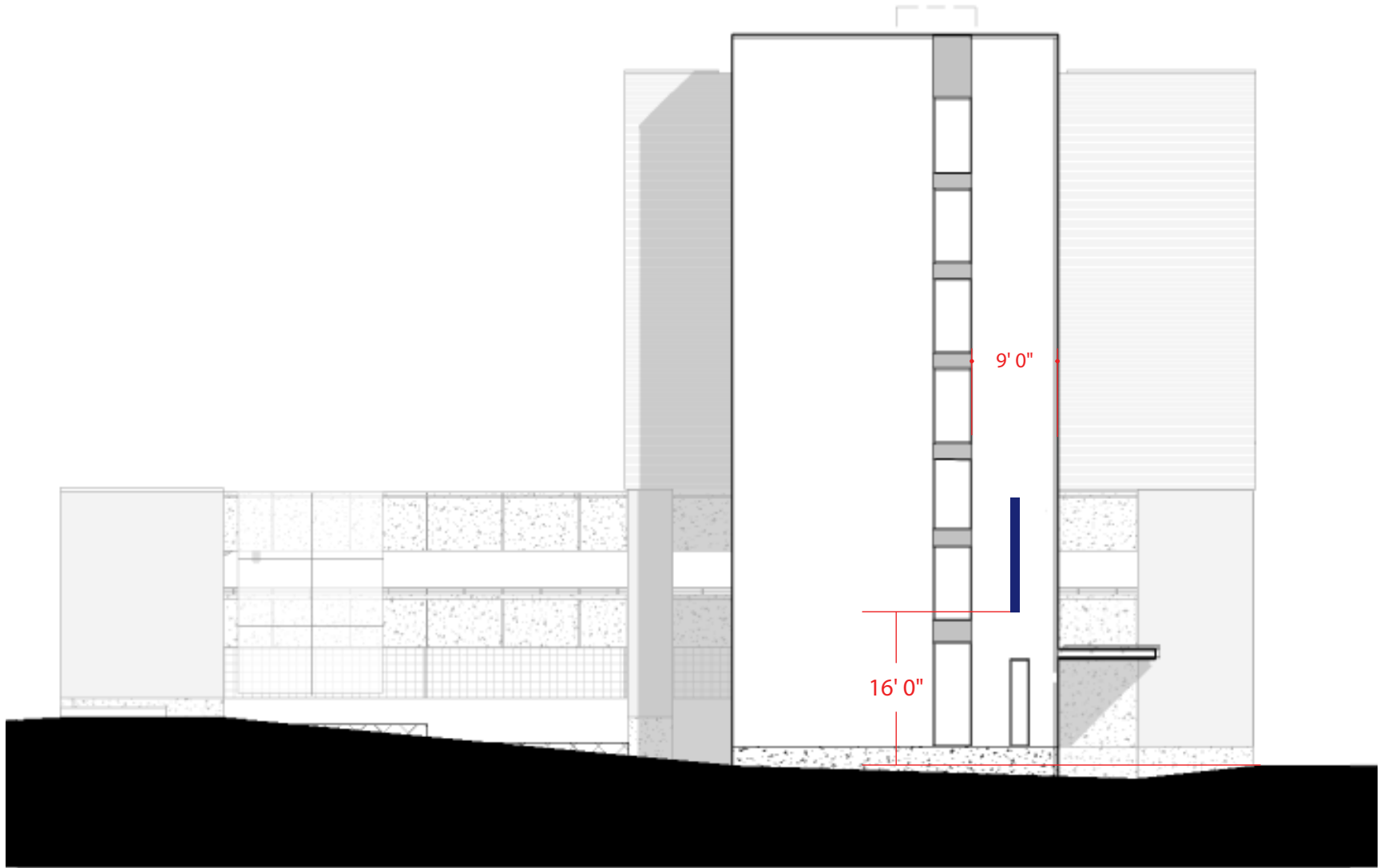

**WEST ELEVATION**  
**SCALE: 1/16" = 1' 0"**  
**FRONTAGE: 124' 6"**

<b>PROCEED TO PRODUCTION</b>	Print 1647GG	Date 8/27/19
	ES# ES-6348	Line C
AUTHORIZED SIGNATURE _____	DATE _____	Ⓢ = Critical Dimension for Internal Quality Control <b>UL FILE NO. E70436</b>



1 Tremco Drive., Terryville, CT 06786 • Phone: 860.582.0233  
 signs@lauretano.com www.lauretano.com

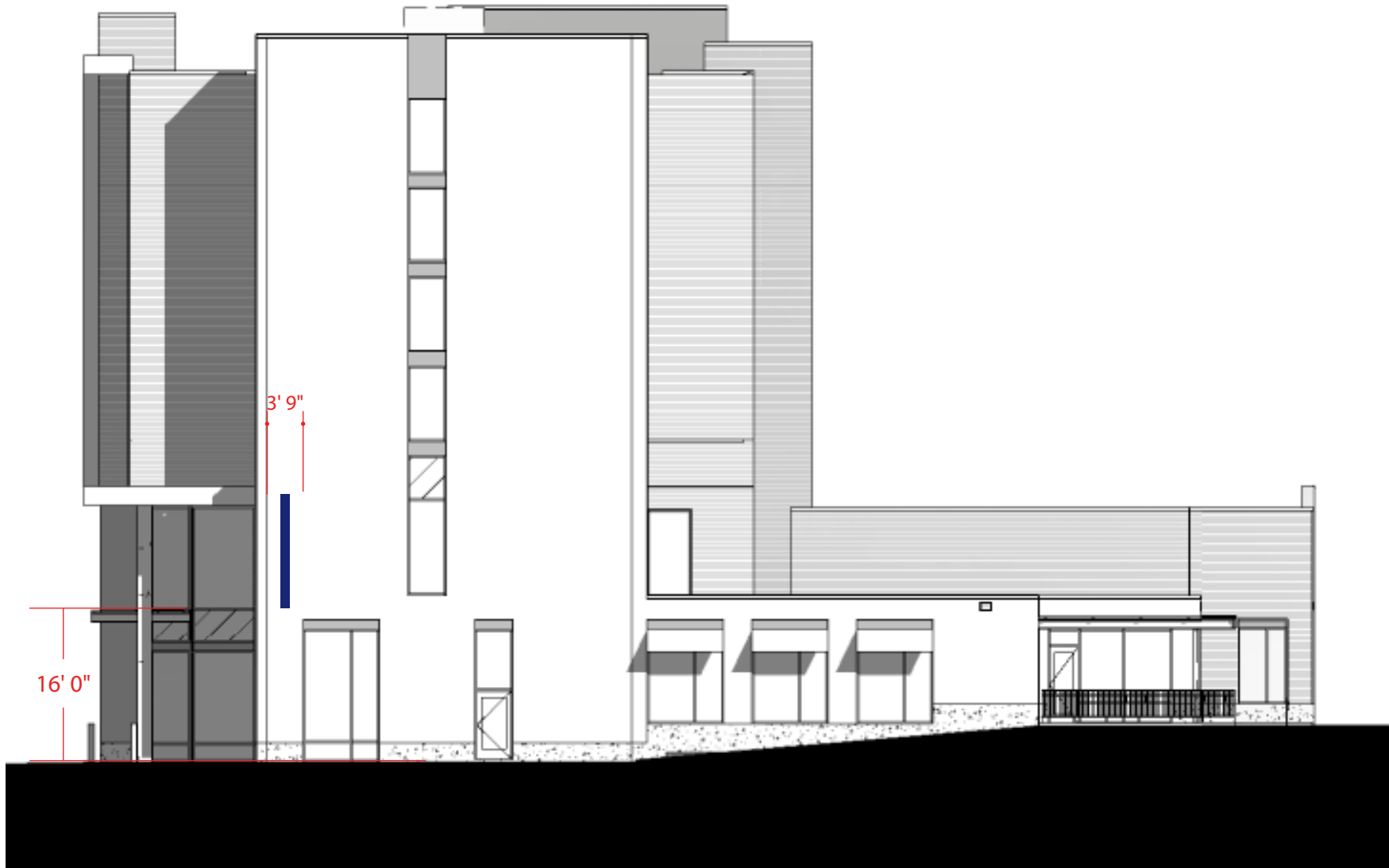

**EAST ELEVATION**  
**SCALE: 1/16" = 1' 0"**  
**FRONTAGE: 129' 0"**

<b>PROCEED TO PRODUCTION</b>	Print 1647GG	Date 8/27/19
	ES# ES-6348	Line C
AUTHORIZED SIGNATURE _____	DATE _____	Ⓢ = Critical Dimension for Internal Quality Control <b>UL FILE NO. E70436</b>

**LAURETANO**  
 SIGN GROUP

1 Tremco Drive., Terryville, CT 06786 • Phone: 860.582.0233  
 signs@lauretano.com www.lauretano.com

Scale: 3/4" = 1' 0"

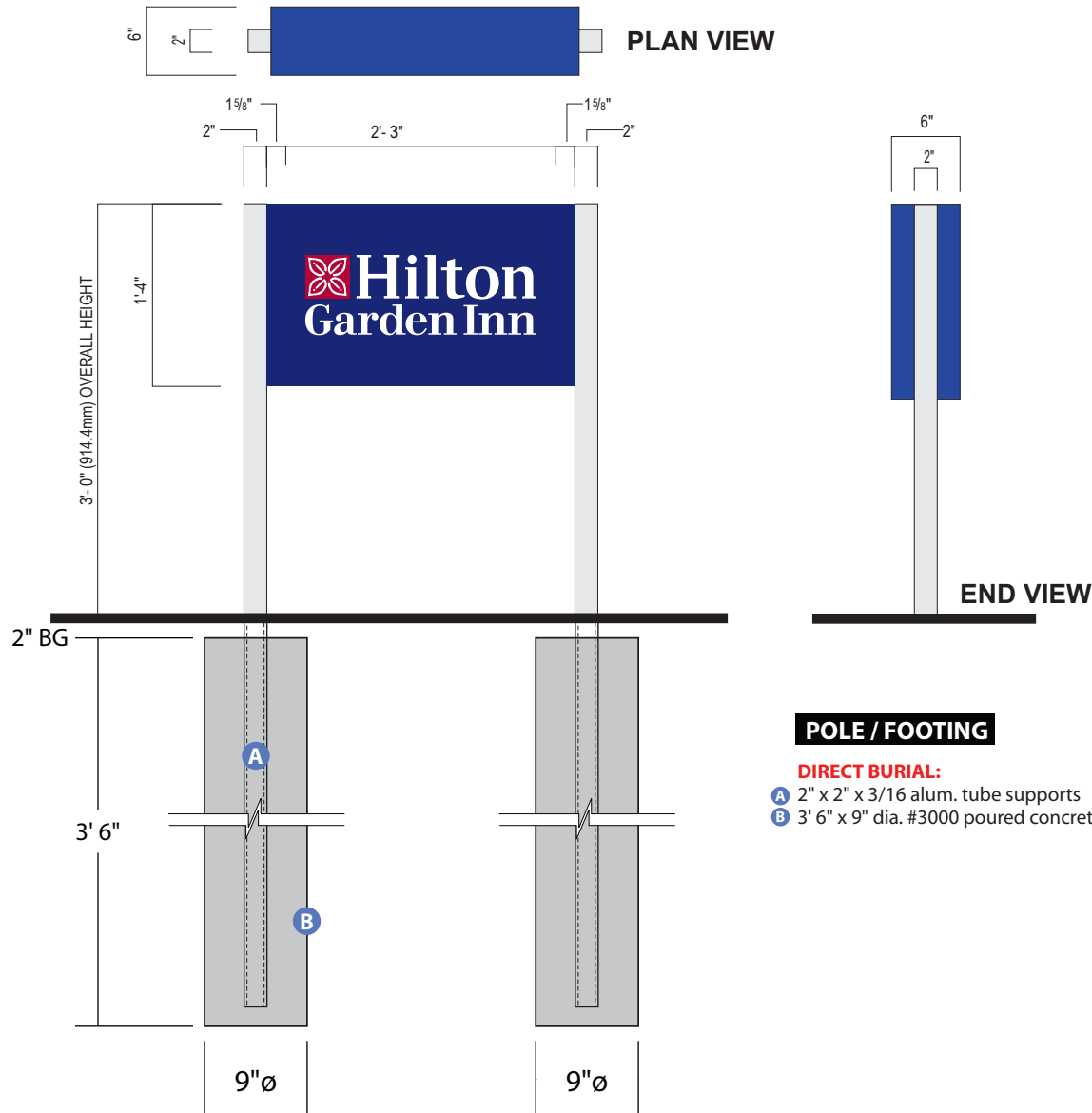

Print 1604GG-3	Date 8/26/19	ES# ES-6348	Line D	SP AC	Sign Type	Custom HGI-D-4
<b>CLIENT APPROVAL</b>		Title	Hilton Garden Inn		Location	Ref. Site Plan
		City/State	Madison, WI		Size	1' 5" x 2' 3" (3 sq ft)
AUTHORIZED SIGNATURE _____ DATE _____		Customer	Hilton Garden Inn		Description	OAH: 3' 0"
		Int. Note	SFNI directional			

**LAURETANO**  
SIGN GROUP

1 Tremco Drive. Terryville, CT 06786  
phone: 860.582.0233 fax: 860.583.0949  
signs@lauretano.com www.lauretano.com





**SOUTH ELEVATION**  
**SCALE: 1/16" = 1' 0"**  
**FRONTAGE: 323' 0"**



Print 1648GG	Date 8/27/19	ES# ES-6348	Line E	SP AC	Sign Type	DFI Blade Sign
<b>CLIENT APPROVAL</b>		Title	Hilton Garden Inn		Location	South Elevation
		City/State	Madison, WI		Size	4' 0" diameter (16 sq ft)
AUTHORIZED SIGNATURE		Customer	Hilton Garden Inn		Description	Cut-thru backed up sign
		DATE	Int. Note			

**LAURETANO**  
 SIGN GROUP

1 Tremco Drive. Terryville, CT 06786  
 phone: 860.582.0233 fax: 860.583.0949  
 signs@lauretano.com www.lauretano.com

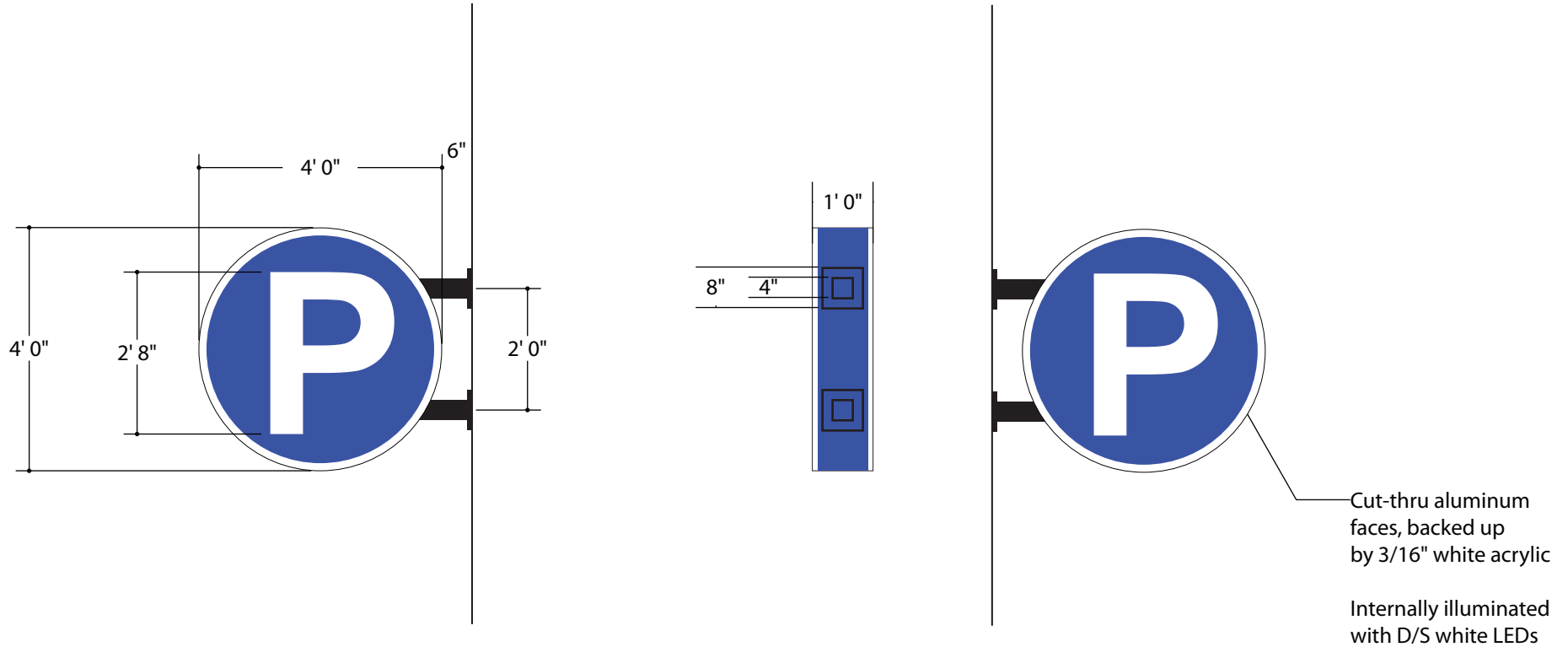
Scale: 3/8" = 1' 0"



<b>PROCEED TO PRODUCTION</b>	Print 1648GG	Date 8/27/19	Installation Method <b>ENGINEERING REQUIRED</b>
	ES# ES-6348	Line E	
AUTHORIZED SIGNATURE _____	 = Critical Dimension for Internal Quality Control	<b>UL FILE NO. E70436</b>	Amps TBD
DATE _____			Volts 120
<b>2 of 2</b>	This drawing contains original elements created by Lauretano Sign Group, Inc., is property of Lauretano Sign Group, Inc. and is subject to all applicable copyright laws. This drawing may not be used in any way until full payment is received by Lauretano Sign Group, Inc. It is intended for review and approval purposes only, and is not to be reproduced, copied, transmitted by electronic media, or exhibited in any fashion to anyone outside your organization without the expressed written consent of Lauretano Sign Group, Inc.		 1 Tremco Drive., Terryville, CT 06786 • Phone: 860.582.0233 signs@lauretano.com www.lauretano.com



**SOUTH ELEVATION**  
**SCALE: 1/16" = 1' 0"**  
**FRONTAGE: 323' 0"**

Print 8814GG-4	Date 8/27/19	ES# ES-6348	Line E	SP AC	Sign Type	DFI Blade Sign
<b>CLIENT APPROVAL</b>		Title	Hilton Garden Inn		Location	South Elevation
		City/State	Madison, WI		Size	3' 0" diameter (9 sq ft)
AUTHORIZED SIGNATURE		Customer	Hilton Garden Inn		Description	Cut-thru backed up sign
		DATE	Int. Note			

**LAURETANO**  
 SIGN GROUP

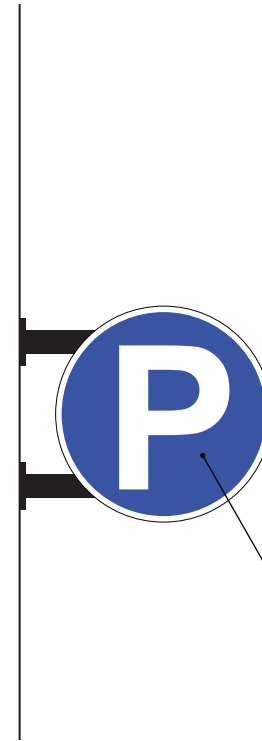
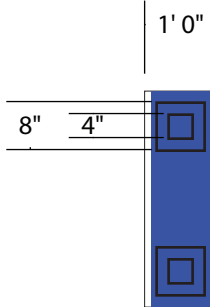
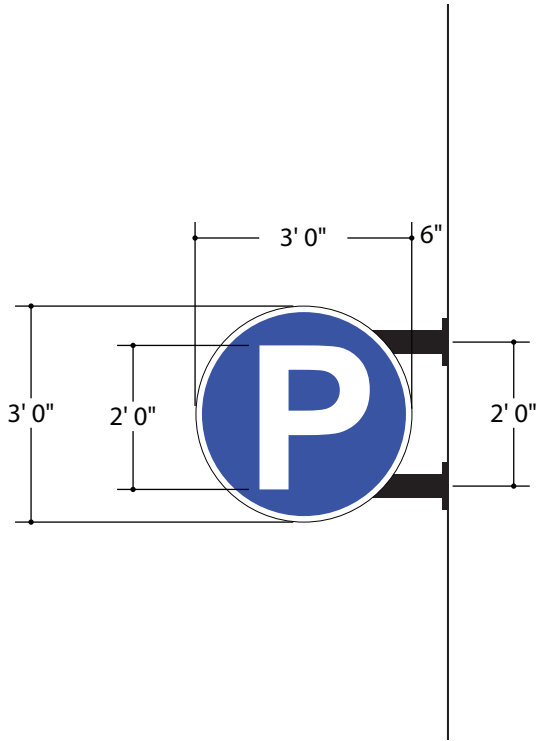

1 Tremco Drive. Terryville, CT 06786  
 phone: 860.582.0233 fax: 860.583.0949  
 signs@lauretano.com www.lauretano.com

Scale: 3/8" = 1' 0"



Cut-thru aluminum faces, backed up by 3/16" white acrylic

Internally illuminated with D/S white LEDs

<b>PROCEED TO PRODUCTION</b>	Print 8814GG-4	Date 8/27/19	Installation Method <b>ENGINEERING REQUIRED</b>
	ES# ES-6348	Line E	
AUTHORIZED SIGNATURE _____	 = Critical Dimension for Internal Quality Control	<b>UL FILE NO. E70436</b>	Amps TBD
DATE _____			Volts 120
<b>2 of 2</b>	This drawing contains original elements created by Lauretano Sign Group, Inc., is property of Lauretano Sign Group, Inc. and is subject to all applicable copyright laws. This drawing may not be used in any way until full payment is received by Lauretano Sign Group, Inc. It is intended for review and approval purposes only, and is not to be reproduced, copied, transmitted by electronic media, or exhibited in any fashion to anyone outside your organization without the expressed written consent of Lauretano Sign Group, Inc.		 1 Tremco Drive., Terryville, CT 06786 • Phone: 860.582.0233 signs@lauretano.com www.lauretano.com



**SOUTH ELEVATION**  
**SCALE: 1/16" = 1' 0"**  
**FRONTAGE: 323' 0"**

Print 8818GG-3	Date 8/26/19	ES# ES-6348	Line F	SP AC	Sign Type HGI-PLQ
<b>CLIENT APPROVAL</b>		Title Hilton Garden Inn			Location South Elevation
		City/State Madison, WI			Size 1' 0" x 3' 0" (3 sq ft)
AUTHORIZED SIGNATURE _____ DATE _____		Customer Hilton Garden Inn			Description Fabricated stainless steel plaque
		Int. Note			with etched/filled graphics



1 Tremco Drive. Terryville, CT 06786  
 phone: 860.582.0233 fax: 860.583.0949  
 signs@lauretano.com www.lauretano.com

Scale: 1" = 1' 0"



\* FABRICATED WALL PLAQUE WITH BLACK PAINT FILLED  
PHOTO ETCHED LOGO GRAPHICS

**SPECIFICATIONS:**

SIGNS ARE CRAFTED FROM SHEET MATERIAL RATHER THAN SOLID PLATE - THIS GREATLY REDUCES WEIGHT AND ALLOWS A GREATER DEPTH TO SIGN.

STAINLESS STEEL IS PREFERRED MATERIAL BECAUSE OF DURABILITY AND COLOR RELATIONSHIP TO OTHER PRODUCTS IN SIGN SYSTEM.  
FINISH MAY BE POLISHED OR SATIN (LIGHTLY BRUSHED)  
APPLY CLEAR COAT FINISH TO COMPLETED SIGN.

GRAPHICS ARE PHOTO MECHANICALLY ACID ETCHED AND FILLED WITH BLACK PIGMENT FOR VERY CLEAN, DURABLE AND ACCURATE REPRODUCTION.

MOUNT PLAQUES FLUSH TO WALL WITH NON-CORROSIVE CONCEALED FASTENERS AND ANCHORS - WALL MATERIAL WILL DETERMINE MOUNTING METHODS.

<b>PROCEED TO PRODUCTION</b>	Print 8818GG-3	Date 8/26/19	
	ES# ES-6348	Line F	
	 = Critical Dimension for Internal Quality Control	<b>UL FILE NO. E70436</b>	
AUTHORIZED SIGNATURE _____	DATE _____		



1 Tremco Drive., Terryville, CT 06786 • Phone: 860.582.0233  
signs@lauretano.com www.lauretano.com

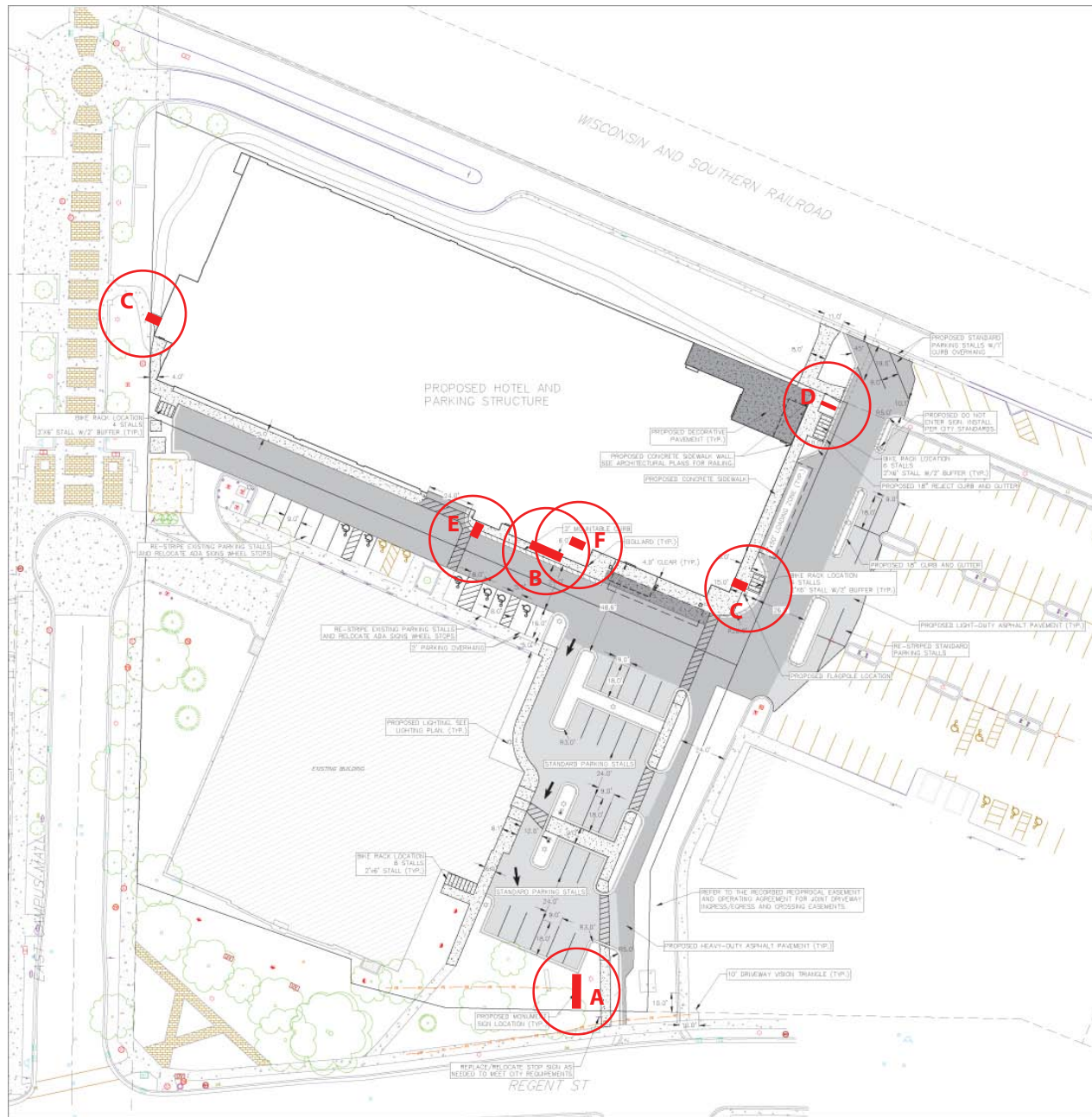

Print 8817GG-4	Date 8/27/19	ES# ES-6348	SP AC	SITE PLAN
<b>CLIENT APPROVAL</b>	Title	Hilton Garden Inn		NOT TO SCALE
	City/State	Madison, WI		
AUTHORIZED SIGNATURE	DATE	Customer	Hilton Garden Inn	
		Int. Note		

**LAURETANO**  
SIGN GROUP

1 Tremco Drive. Terryville, CT 06786  
phone: 860.582.0233 fax: 860.583.0949  
signs@lauretano.com www.lauretano.com