



Exact Sciences

Exterior Signage

October 3, 2018
Signage Narrative

ZEBRADOG
DYNAMIC ENVIRONMENT DESIGN

Comprehensive Design Review Criteria. The UDC shall apply the following criteria upon review of an application for a Comprehensive Design Plan:

For your convenience, we are addressing the seven Comprehensive Design Review Criteria as follows:

- 1. The Sign Plan shall create visual harmony between the signs, building(s), and building site through unique and exceptional use of materials, design, color, any lighting, and other design elements; and shall result in signs of appropriate scale and character to the uses and building(s) on the zoning lot as well as adjacent buildings, structures and uses.**

Signage located on the Exact Sciences campus will be clean and timeless. The designs utilize painted aluminum cabinets and precast bases that match the exterior facade of the Exact Science buildings. The main monument sign along the Beltline and directional signs along Schroeder and Rayovac Drive will be internally illuminated. The campus identification letters at the visitor entrance will feature uplighting in the landscaping. All signs are designed and scaled appropriately to the site.

- 2. Each element of the sign plan shall be found to be necessary due to unique or unusual design aspects in the architecture or limitations in the building site or surrounding environment.**

The 49 acre Exact Sciences campus is located off of Schroeder road between Forward and Rayovac Drive. The site has two employee parking lots, one visitor parking lot and a parking garage. There are 20+ loading docks located around the site that will receive 35-50 trucks per day. At the time Exact Sciences has occupancy of the new lab (phase 1) and amenities building (phase 2), they anticipate over 600 employees onsite which will grow to over 1,400 over the course of five years. This includes employees from the clinical laboratory, warehouse, customer care, IT and medical billing departments. Employees will be accessing the site in various work shifts 24 hours a day / 7 days a week. In order to properly direct this volume of traffic to key locations a combination of internally lit directional signs and non - illuminated directional signs will be used at key locations throughout the site.

The Exact Sciences campus also has frontage to the Beltline (Hwy 12/18). There is one existing monument that we are requesting to refurbish in this location that is 71' from the edge of the Beltline. The proposed lower, linear monument sign will keep within the dimensions of the existing monument. This sign design matches the architecture style used on campus and best accommodates the horizontal format of the Exact Sciences logo. The size of the monument sign is in proportion with the amount of Beltline frontage and necessary for proper visibility of the campus.

Due to the placement of buildings on the site and trajectory of the Beltline, there are limited opportunities for wall signage that are visible to both east and westbound traffic. The building materials also limit where wall signage can be located. As a result, only one of the three buildings along the Beltline will have a halo lit wall sign.

- 3. The Sign Plan shall not violate any of the state purposes described in Sec. 31.02(1) and 33.24(2).**

We confirm that the sign plans are designed to further the goals of safety and aesthetics and achieve the purposes outlined in Sec. 31.02(1) and Sec. 33.24(2).

- 4. All signs must meet minimum construction requirements under Sec. 31.04(5).**

We confirm that all signage will meet the minimum construction requirements under 31.04(5).

- 5. The Sign Plan shall not approve Advertising beyond the restrictions in Sec. 31.11 or Off-Premise Directional Signs**



Exact Sciences

Exterior Signage

October 3, 2018
Signage Narrative

ZEBRADOG
DYNAMIC ENVIRONMENT DESIGN

beyond the restrictions in Sec. 31.115.

We confirm that the sign plan does not approve advertising beyond the restriction in Sec. 31.11 or 31.115.

- 6. The Sign Plan shall not be approved if any element of the plan:**
- a. Presents a hazard to vehicular or pedestrian traffic on public or private property,**
 - b. Obstructs views at points of ingress or egress of adjoining properties,**
 - c. Obstructs or impedes the visibility of existing lawful signs on adjacent property, or,**
 - d. Negatively impacts the visual quality of public or private open space.**

We confirm that none of the above exists in the sign plan.

- 7. The Sign Plan may only encompass signs on private property of the zoning lot or building site in question, and shall not approve any signs in the right of way or on private property.**

We confirm that the sign plan only encompasses signs on private property of the zoning lot. Additionally, the signage complies with the stated guidelines for signage.



Exact Sciences

Exterior Signage

October 3, 2018

Signage Compliance With Chapter 31 & UDC District No. 2

ZEBRADOG
DYNAMIC ENVIRONMENT DESIGN

Primary Monument Sign - Type A

Qty: 1

Compliant: Primary monument sign is an allowed sign for this property.

Noncompliant: Chapter 31 code allows an overall height of 12' and a square footage requirement net/gross of 144/288. We are requesting an exception to allow square footage net/gross of 200.5/55.25 in order to reuse the existing monument sign base, yet provide the appropriate visibility.

UDC District No. 2 code allow no greater than 75 square feet of signable area for a detached sign. We are requesting an exception to allow 200.5 square feet.

UDC District No. 2 code requires a minimum setback of 20 feet for all detached signs. We are requesting an exception to allow a setback of 4.5 feet in order to use the existing sign base in its current location.

Illumination: General contractor and sign manufacturer to work together with City of Madison to provide and approve illumination photometrics.

Secondary Monument Signs - Types B1, B2, B3

Qty: 3

Compliant: All Signs meet the overall height allowance of 8' and meet the net/gross square footage requirements of 32/64.

Noncompliant: Requesting an exception to the amount of total ground signs allowed.

Illumination: General contractor and sign manufacturer to work together with City of Madison to provide and approve illumination photometrics.

Campus Identification Letters - Type C

Qty: 1

Compliant: Meets all requirements for Chapter 31 and UDC District No. 2 pedestrian level identification letters.

Illumination: General contractor and sign manufacturer to work together with City of Madison to provide and approve illumination photometrics.

Large Vehicular Directional Signs - Types D1, D2

Qty: 2

Compliant: Meets all requirements for Chapter 31 and UDC District No. 2. directional signs.

Illumination: General contractor and sign manufacturer to work together with City of Madison to provide and approve illumination photometrics.

Small Vehicular Directional Signs - Types E1, E2, E3, E4

Qty: 4

Compliant: Meets all requirements for Chapter 31 and UDC District No. 2. directional signs.

Wall Mounted Channel Letters - Types F1, F2

Qty: 2

Compliant: Chapter 31 and UDC District No. 2. code allows multiple wall signs on multiple facades.

Noncompliant: Chapter 31 code allows 30% coverage on the signable area of the building. We are requesting an exception to allow full coverage on the signable area due to visibility and the materiality of the building.

UDC District No. 2 code requires a maximum size of 40 square feet for wall signs. We are requesting an exception to allow 55.58 square feet on the north elevation and 40.2 square feet on the east elevation.

Illumination: General contractor and sign manufacturer to work together with City of Madison to provide and approve illumination photometrics.

Parking Channel Letters - Types G1, G2

Qty: 2

Compliant: Meets all requirements for Chapter 31 and UDC District No. 2. parking egress signage.

Illumination: General contractor and sign manufacturer to work together with City of Madison to provide and approve illumination photometrics.

Exact Sciences

Discovery Campus
October 3, 2018

Signage Review

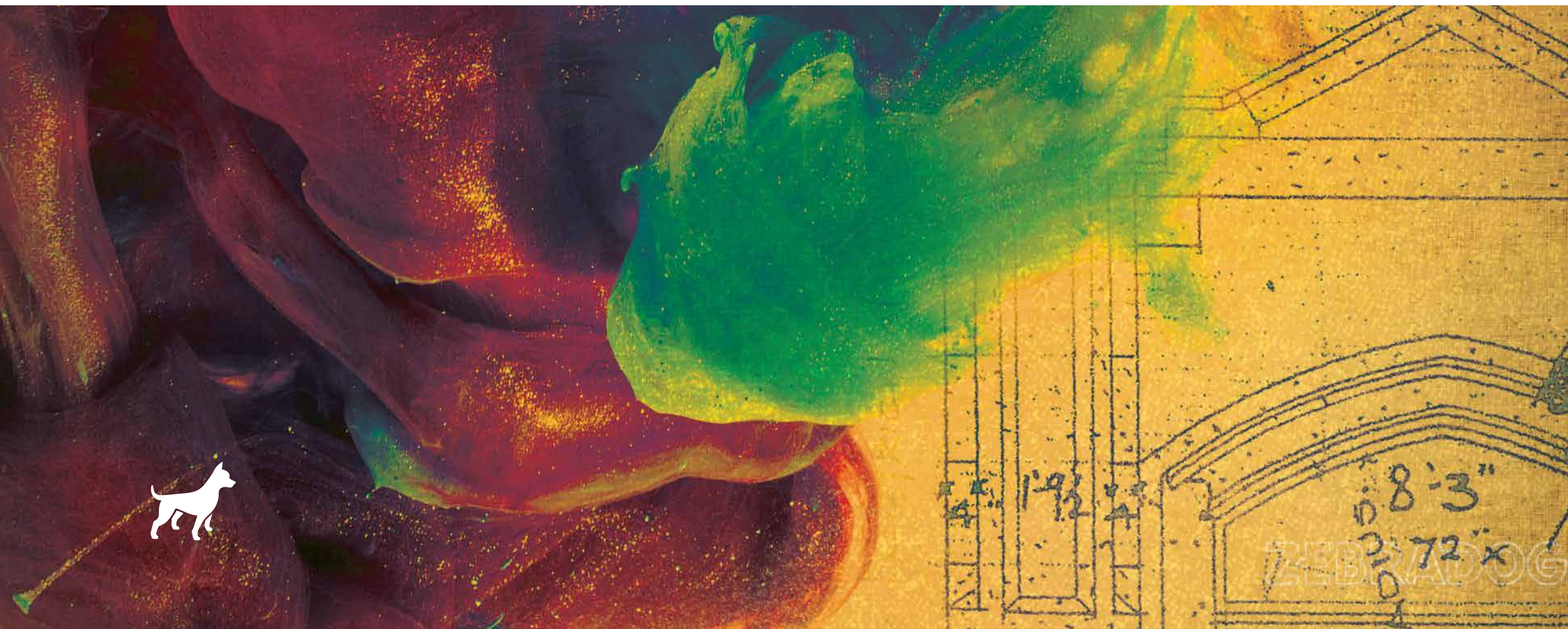



- Ground Monument / Directional Signage
 - Building Facade Signage
- A. Large Monument (Internally Lit)
 - B. Directional Monument (Internally Lit)
 - C. Campus Identification Letters (Externally Lit)
 - D. Large Vehicular Directional Signage (Internally Lit)
 - E. Small Vehicular Directional Signage (Non-Lit)
 - F. Building Facade Signage (Halo Lit)
 - G. Parking Structure Signage (Internally Lit)



SIGN TYPE A - LARGE MONUMENT
(INTERNALLY LIT)

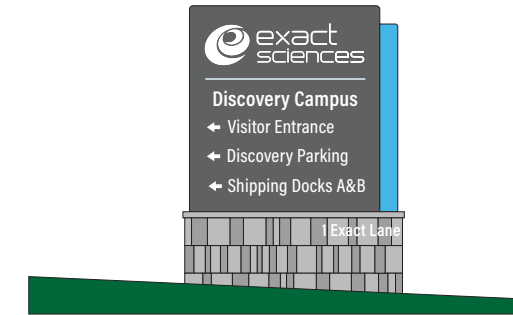

SIGN TYPE B - DIRECTIONAL MONUMENT
(INTERNALLY LIT)

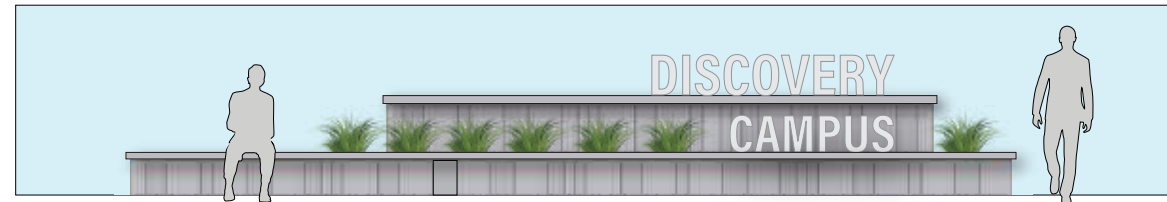

SIGN TYPE C
CAMPUS IDENTIFICATION LETTERS
(EXTERNALLY LIT)

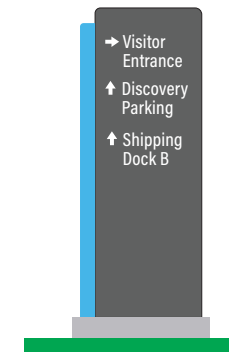

SIGN TYPE D
LARGE VEHICULAR DIRECTIONAL
(INTERNALLY LIT)

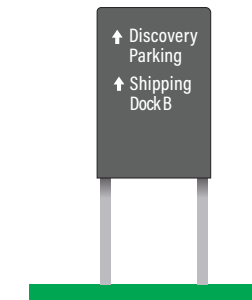

SIGN TYPE E
SMALL VEHICULAR DIRECTIONAL



SIGN TYPE F - BUILDING FACADE ID
(HALO-LIT)

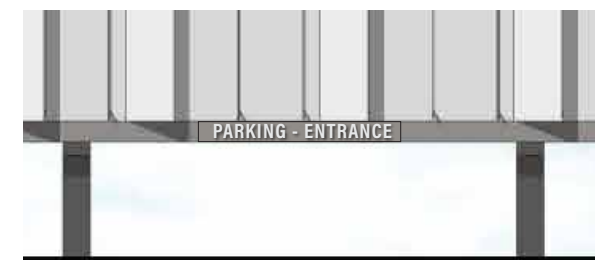

SIGN TYPE G
PARKING GARAGE SIGNAGE
(INTERNALLY LIT)

SIGNAGE SPECIFICATIONS

SIGN TYPE A - LARGE MONUMENT

CONSTRUCTION

New cabinet to fit over existing foundation and be attached to existing poles. New base design to be applied over existing foundation. Total sign to not exceed size of existing signage.

Fabricate aluminum cabinets to shape. Base to match precast finish of campus building architecture, to be set within landscaping.

Cabinet to be painted aluminum with white acrylic section between front and back faces. Acrylic to have translucent colored vinyl and be internally lit with white LED's. White acrylic push-through lettering with vinyl graphic faces, backlit with white LED's, double-sided.

ILLUMINATION

Internally lit with white LED's. To meet maximum guidelines for the City of Madison Wisconsin.

WIND LOAD

Withstand up to 75 MPH winds

NET AREA - 8'-6" H x 23'-7" W

200.5 Square Feet
55.25 Base Square Footage

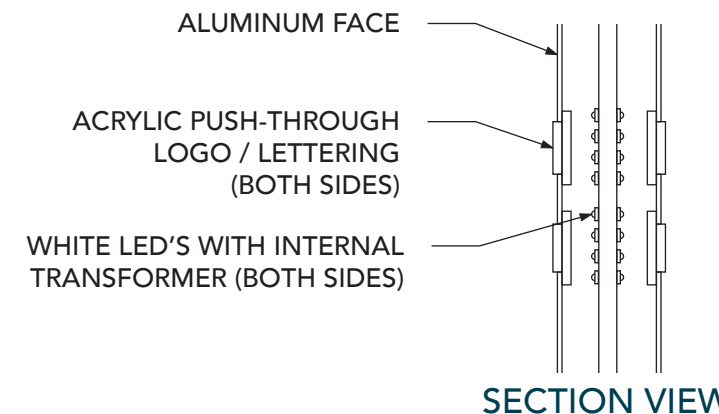
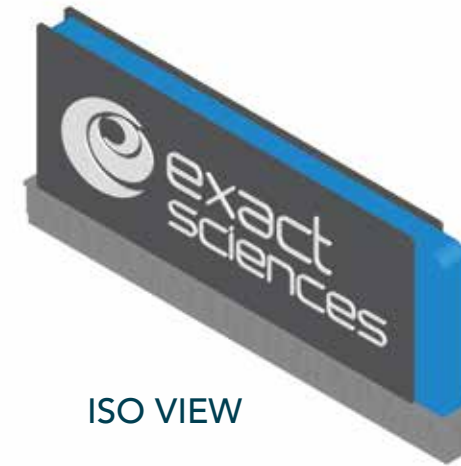
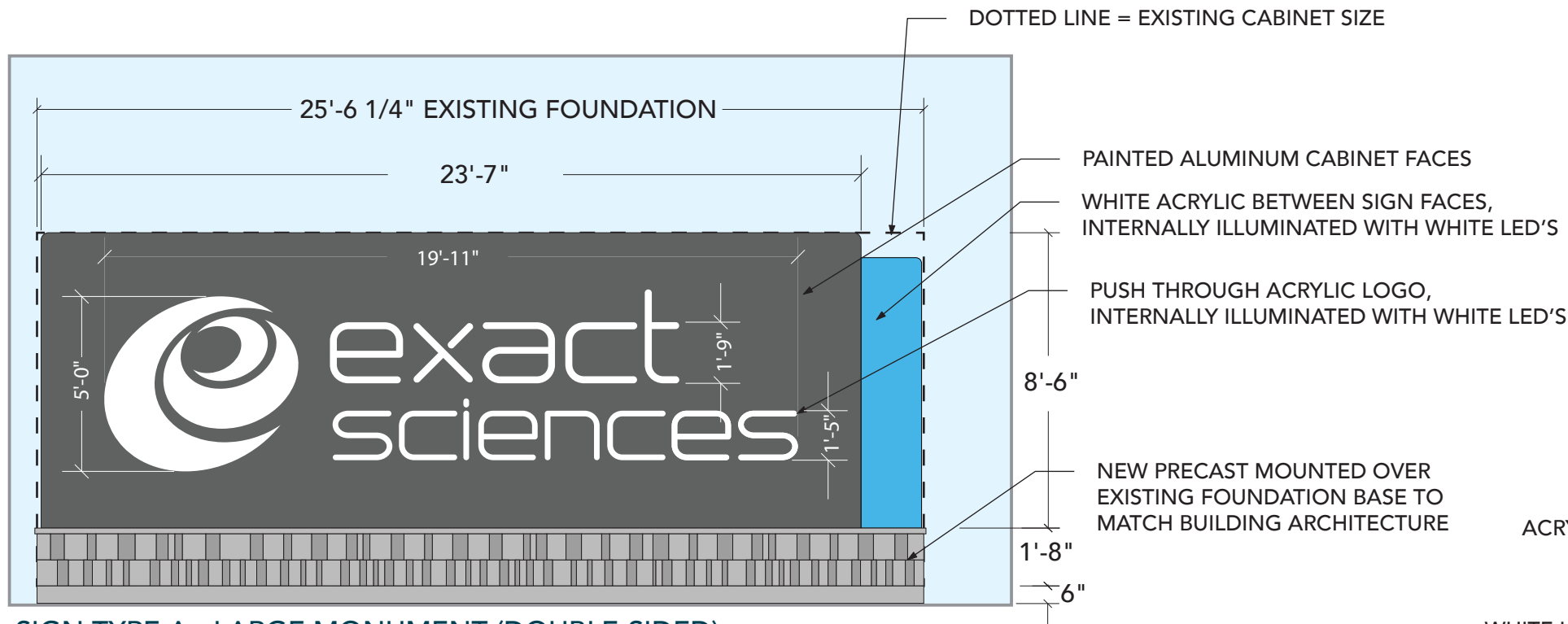

SIGN TYPE A - LARGE MONUMENT (DOUBLE-SIDED)
NEW SIGN TO USE EXISTING MONUMENT STRUCTURE (INTERNALLY LIT)

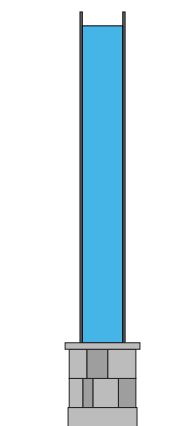
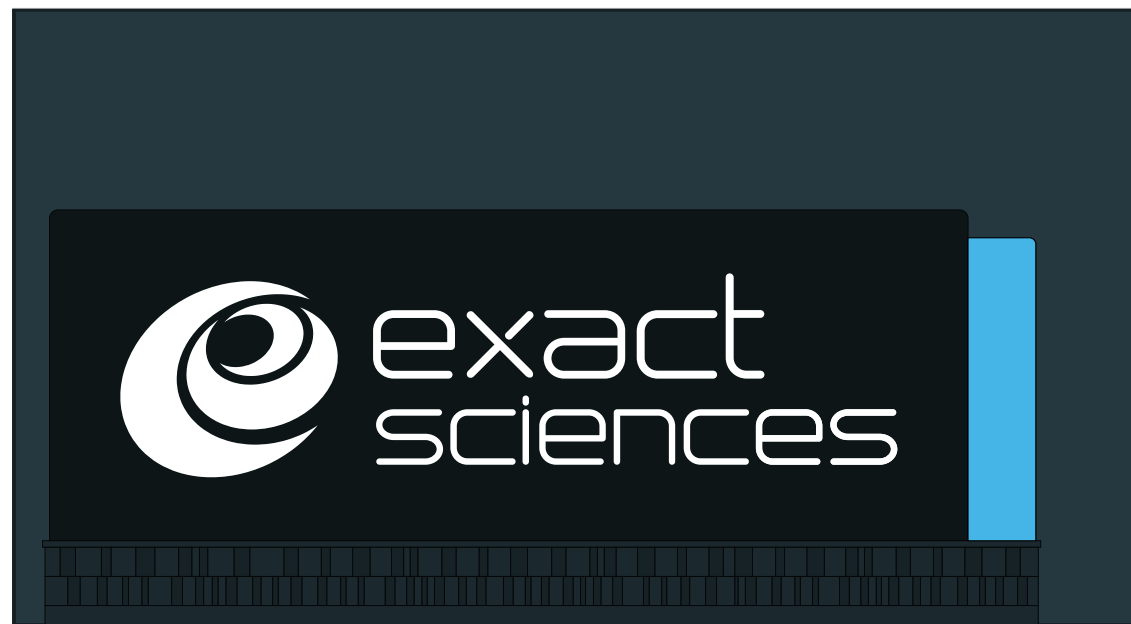





SIGNAGE SPECIFICATIONS

SIGN TYPE B - DIRECTIONAL MONUMENT

CONSTRUCTION

Fabricate aluminum cabinets to shape. Base to match precast finish of campus building architecture, to be set within landscaping.

Cabinet to be painted aluminum with white acrylic section between front and back faces. Acrylic to have translucent colored vinyl and be internally lit with white LED's. White acrylic push-through lettering with vinyl graphic faces, backlit with white LED's, double-sided.

ILLUMINATION

Internally lit with white LED's. To meet maximum guidelines for the City of Madison Wisconsin.

WIND LOAD

Withstand up to 75 MPH winds

NOTE: Final directional content to be submitted at an administrative level once logistics have been determined.

NET AREA - 5'-7" H x 5'-2" W

28.85 Square Feet
14.5 Base Square Footage

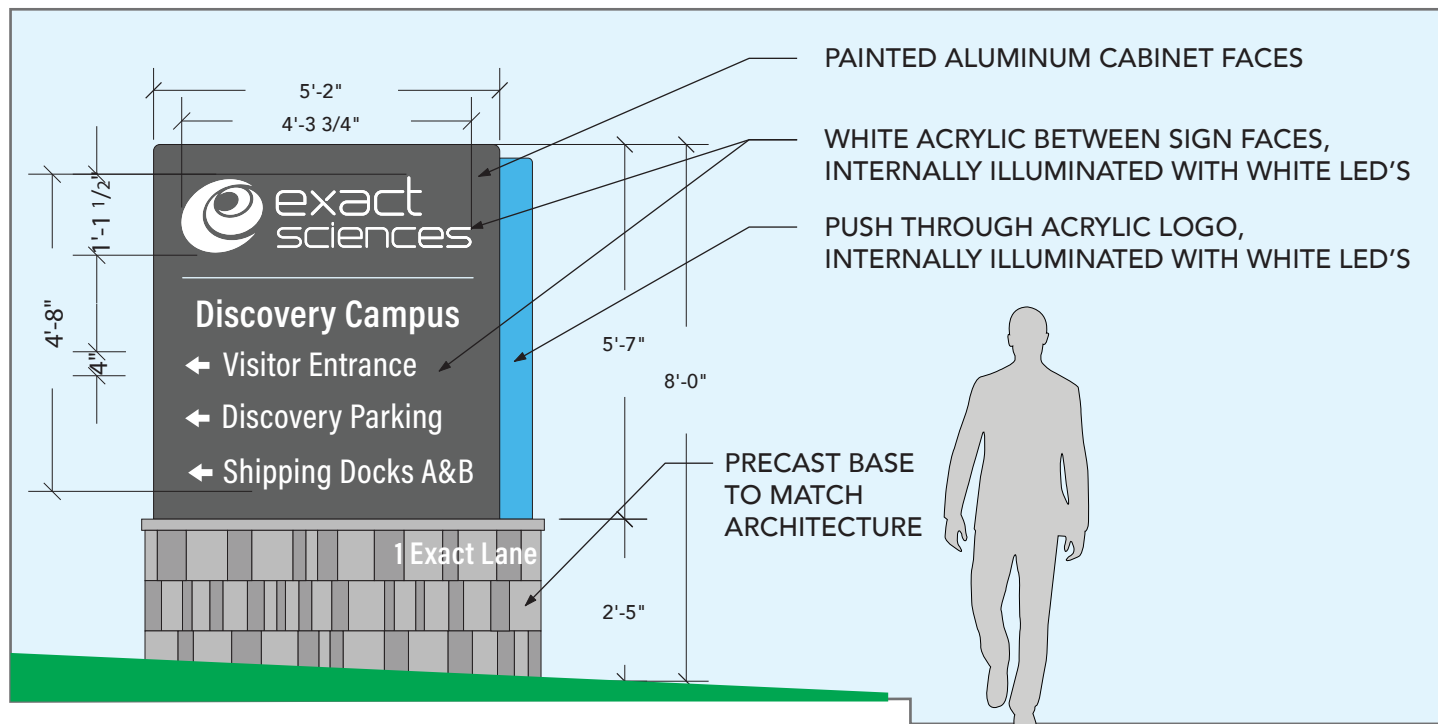

SIGN TYPE B
DIRECTIONAL MONUMENT

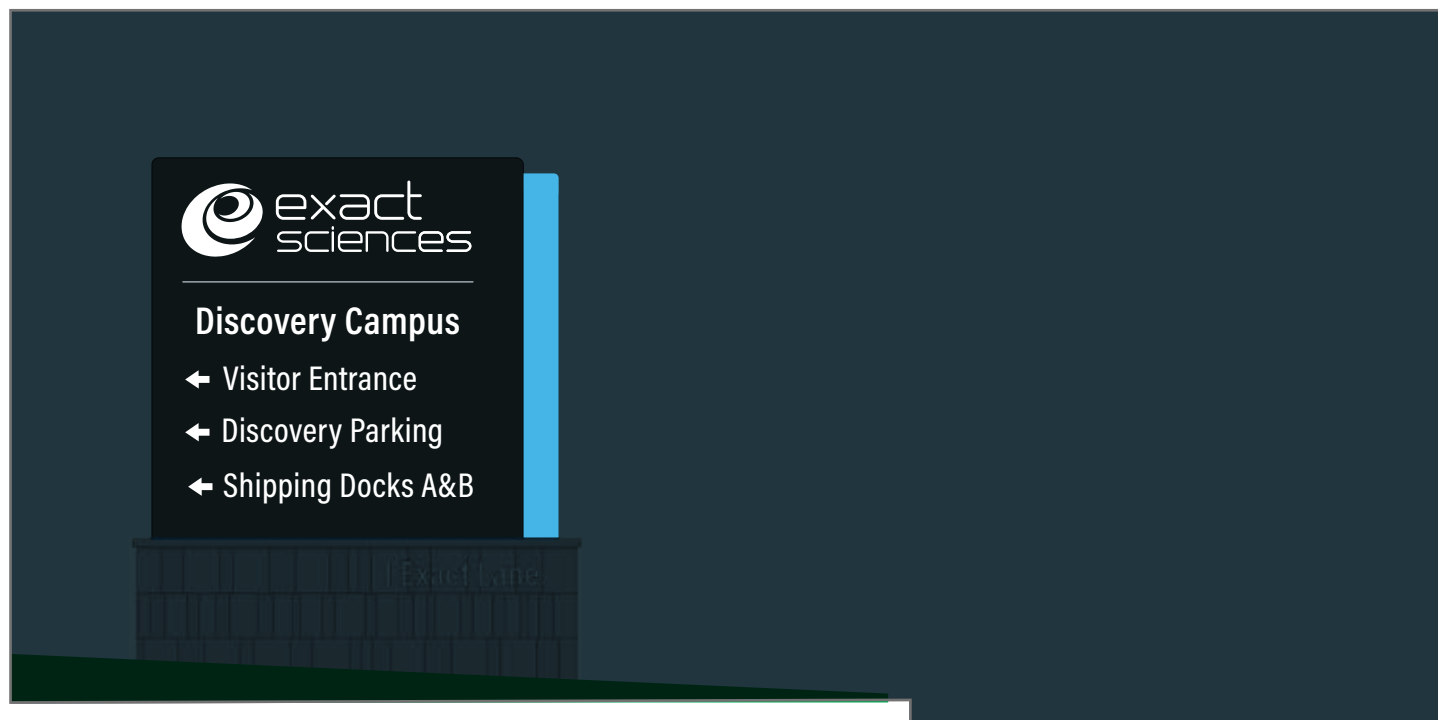

NIGHT VIEW - INTERNALLY LIT



ISO VIEW

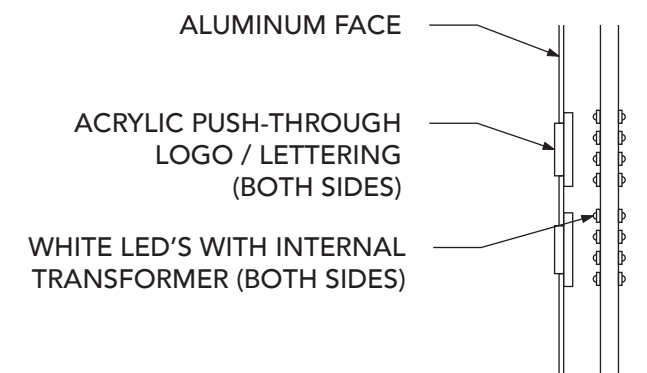

SECTION VIEW

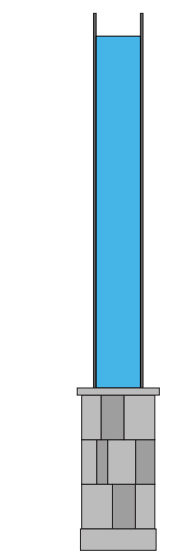

SIDE VIEW



Existing Sign Conditions

SIGNAGE SPECIFICATIONS

SIGN TYPE B - DIRECTIONAL MONUMENT

CONSTRUCTION

Fabricate aluminum cabinets to shape. Base to match precast finish of campus building architecture, to be set within landscaping.

Cabinet to be painted aluminum with white acrylic section between front and back faces. Acrylic to have translucent colored vinyl and be internally lit with white LED's. White acrylic push-through lettering with vinyl graphic faces, backlit with white LED's, double-sided.

ILLUMINATION

Internally lit with white LED's. To meet maximum guidelines for the City of Madison Wisconsin.

WIND LOAD

Withstand up to 75 MPH winds

NOTE: Final directional content to be submitted at an administrative level once logistics have been determined.

NET AREA - 5'-7" H x 5'-2" W

28.85 Square Feet

14.5 Base Square Footage

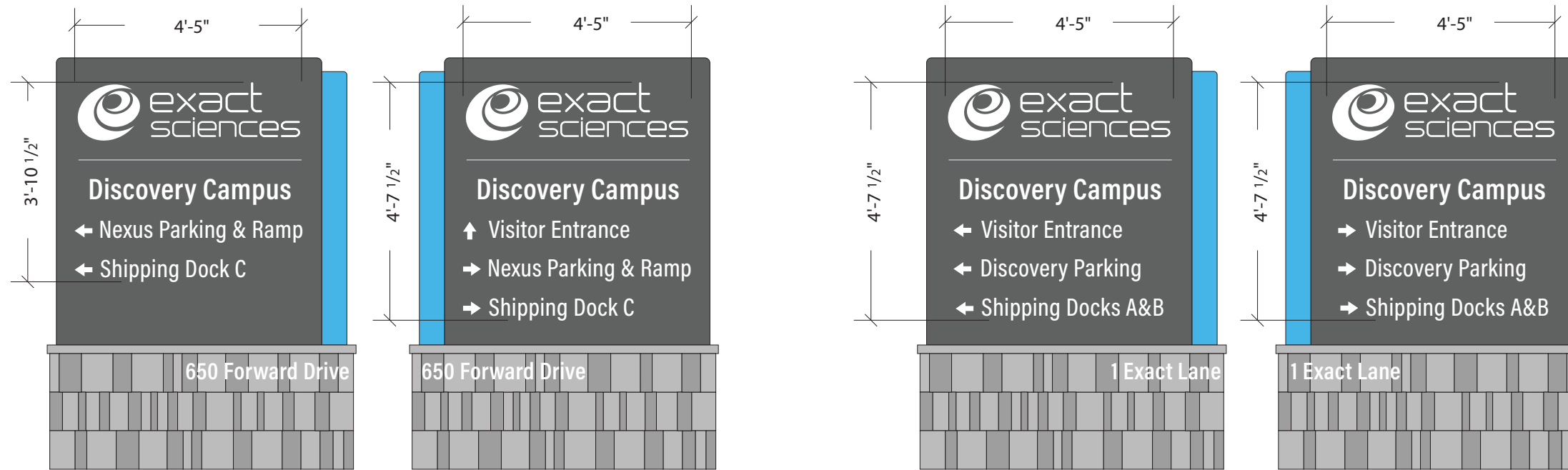

SCHROEDER RD AND FORWARD DR (B1)

SCHROEDER RD AND RAYOVAC DR (B2)

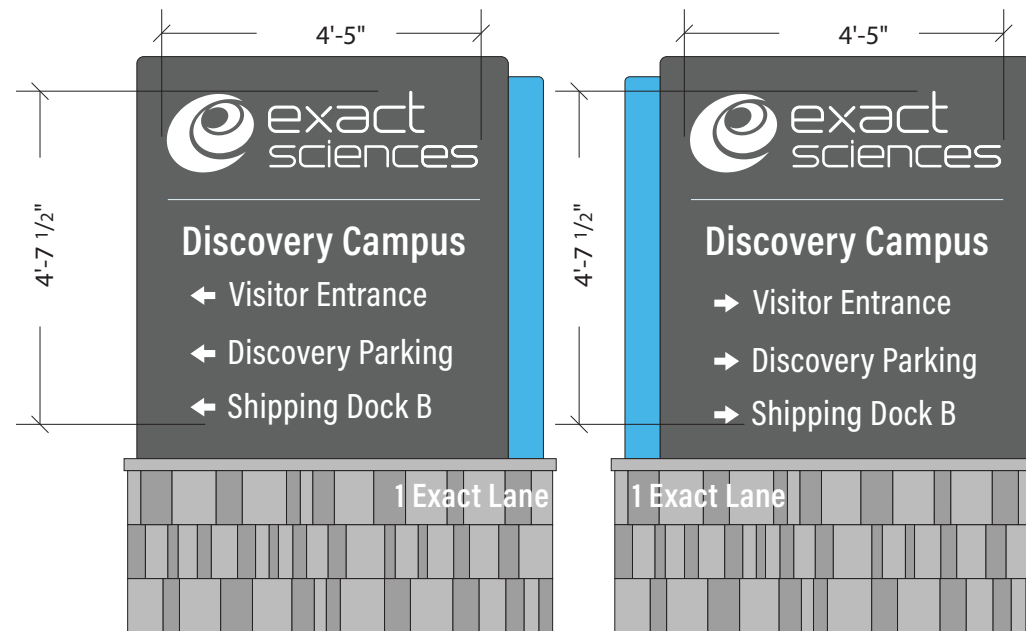

RAYOVAC DR AND EXACT LANE (B3)

SIGN TYPE B DIRECTIONAL MONUMENT

SIGNAGE SPECIFICATIONS

SIGN TYPE C - CAMPUS IDENTIFICATION LETTERS

CONSTRUCTION

Base to match precast finish of campus building architecture, to be set within landscaping and/or front entrance conditions.
Lower cap of base to have RGB LED underlighting.
Fabricate 6" D aluminum letters with white LED uplighting, mounted to base.
Channel letter faces to be up-lit with white LED's.

Landscaping within base determined by landscape architect and owner.

ILLUMINATION

Up lit with white LED's.
To meet maximum guidelines for the City of Madison Wisconsin.

WIND LOAD

Withstand up to 75 MPH winds

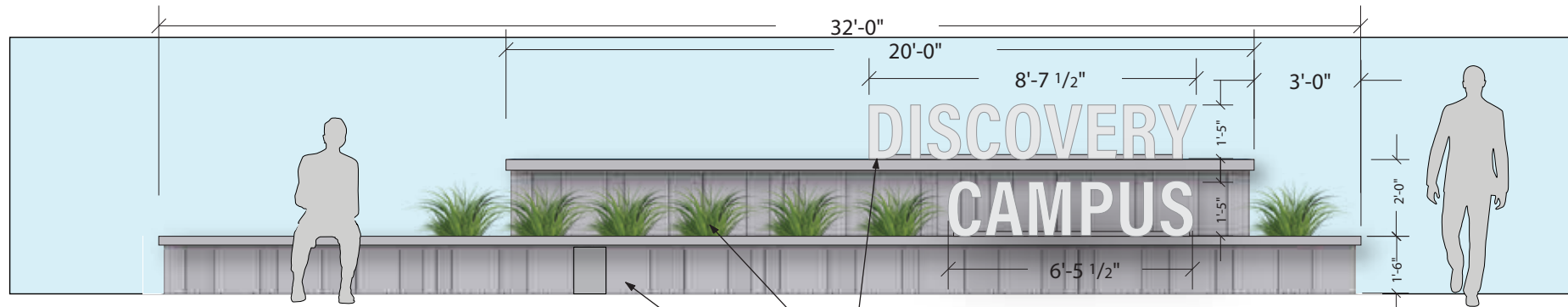

SIGN TYPE C
CAMPUS IDENTIFICATION LETTERS

6" D ALUMINUM LETTERS WITH WHITE LED UPLIGHTING

LANDSCAPING DETERMINED BY LANDSCAPE ARCHITECT AND OWNER

PRECAST BASE TO MATCH ARCHITECTURE



NIGHT VIEW
EXTERNALLY LIT

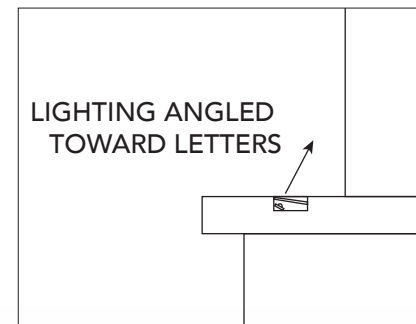

Lighting Comparison

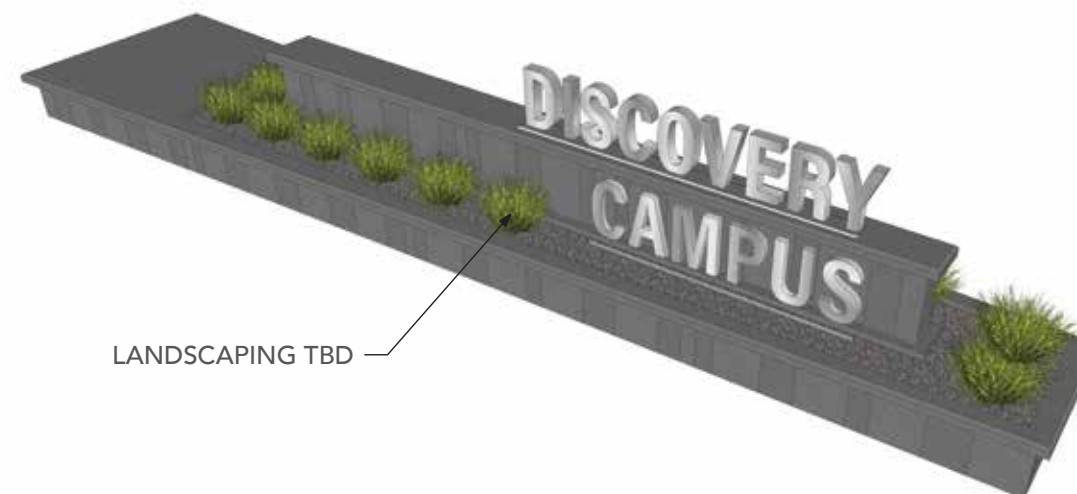

SIGNAGE SPECIFICATIONS

SIGN TYPE D - LARGE VEHICULAR DIRECTIONAL

CONSTRUCTION

Fabricate aluminum cabinets to shape. Base to match precast finish of campus building architecture, to be set within landscaping.

Cabinet to be painted aluminum with white acrylic section between front and back faces. Acrylic to have translucent colored vinyl and be internally lit with white LED's. White acrylic push-through lettering with vinyl graphic faces, backlit with white LED's, double-sided.

ILLUMINATION

Internally lit with white LED's. To meet maximum guidelines for the City of Madison Wisconsin.

WIND LOAD

Withstand up to 75 MPH winds

NET AREA - 7'-6" H x 2'-7" W

19.375 Square Feet
1.67 Base Square Footage

NOTE: Final directional content to be submitted at an administrative level once logistics have been determined.

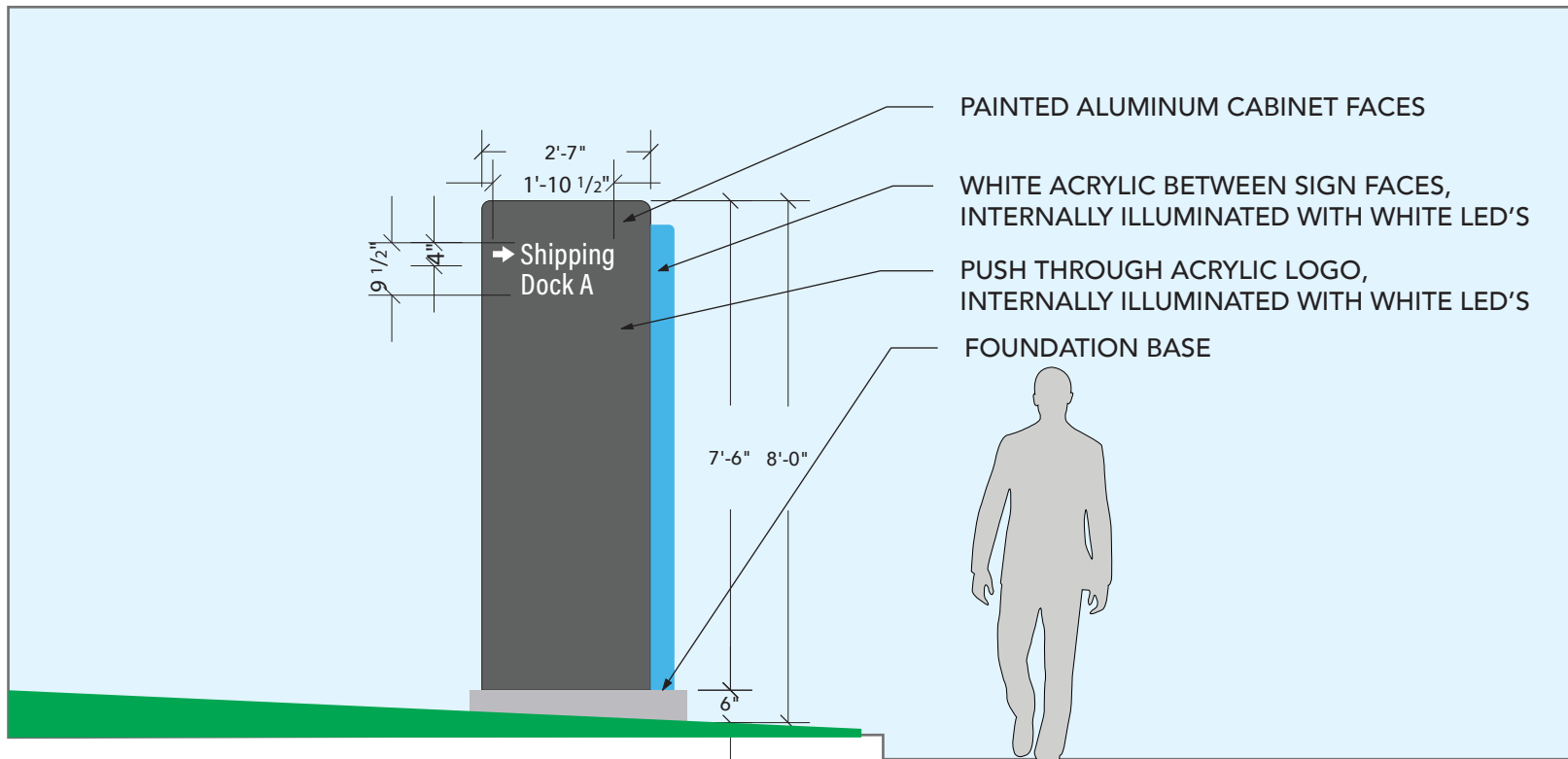

SIGN TYPE D
LARGE VEHICULAR DIRECTIONAL

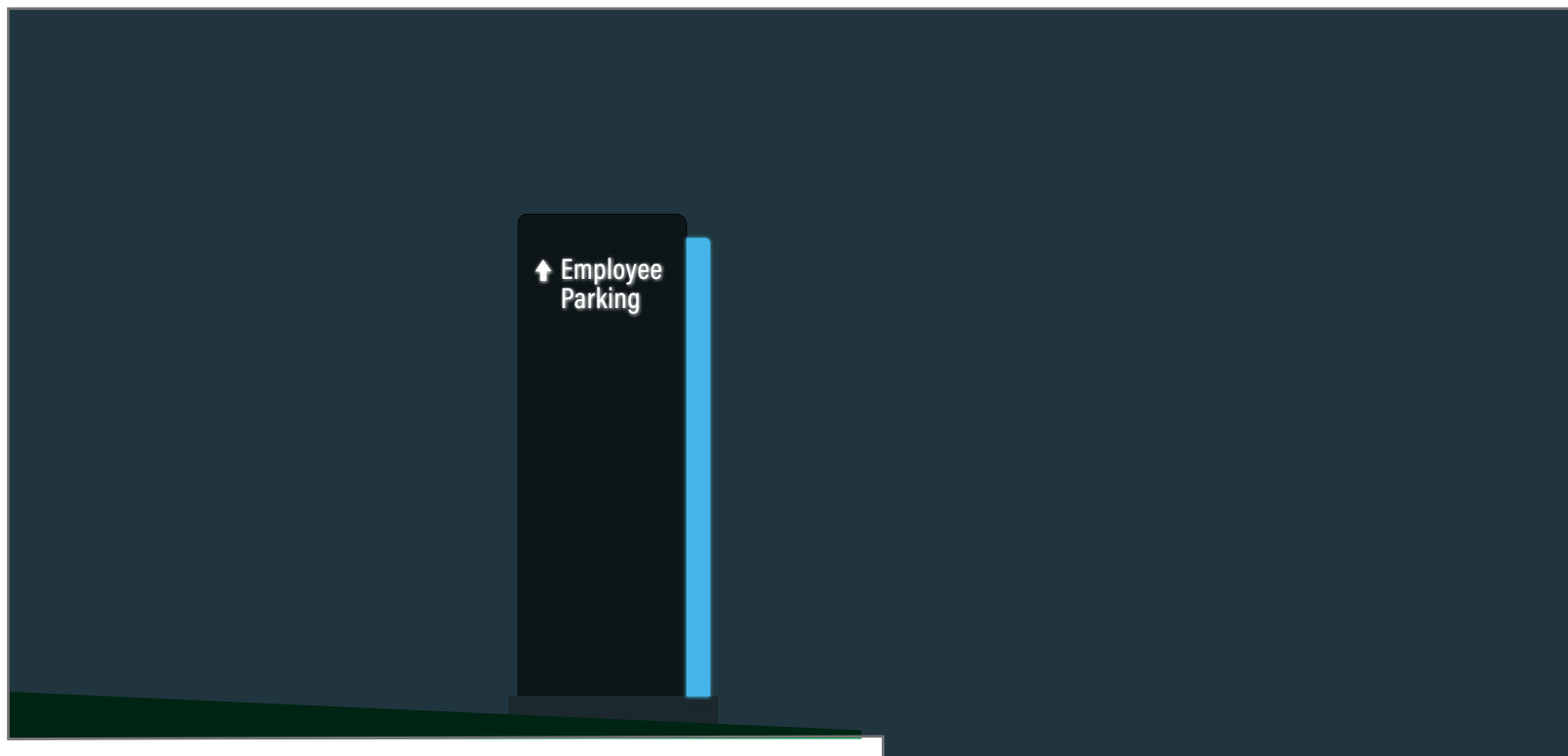

NIGHT VIEW
INTERNALLY LIT



ISO VIEW

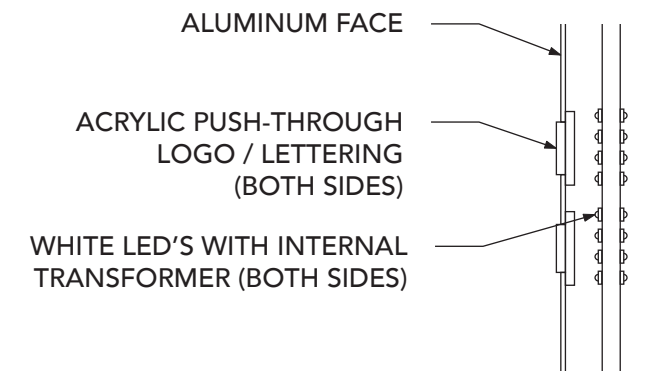

SECTION VIEW

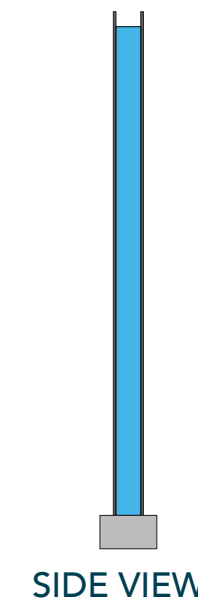

SIDE VIEW

SIGNAGE SPECIFICATIONS

SIGN TYPE D - LARGE VEHICULAR DIRECTIONAL

CONSTRUCTION

Fabricate aluminum cabinets to shape. Base to match precast finish of campus building architecture, to be set within landscaping.

Cabinet to be painted aluminum with white acrylic section between front and back faces. Acrylic to have translucent colored vinyl and be internally lit with white LED's. White acrylic push-through lettering with vinyl graphic faces, backlit with white LED's, double-sided.

ILLUMINATION

Internally lit with white LED's. To meet maximum guidelines for the City of Madison Wisconsin.

WIND LOAD

Withstand up to 75 MPH winds

NET AREA - 7'-6" H x 2'-7" W

19.375 Square Feet
1.67 Base Square Footage

NOTE: Final directional content to be submitted at an administrative level once logistics have been determined.

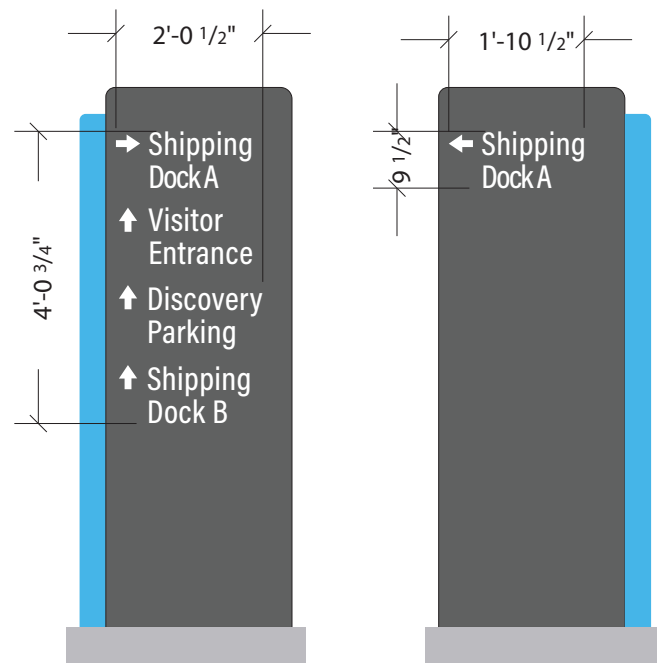

RAYOVAC DR (D1)

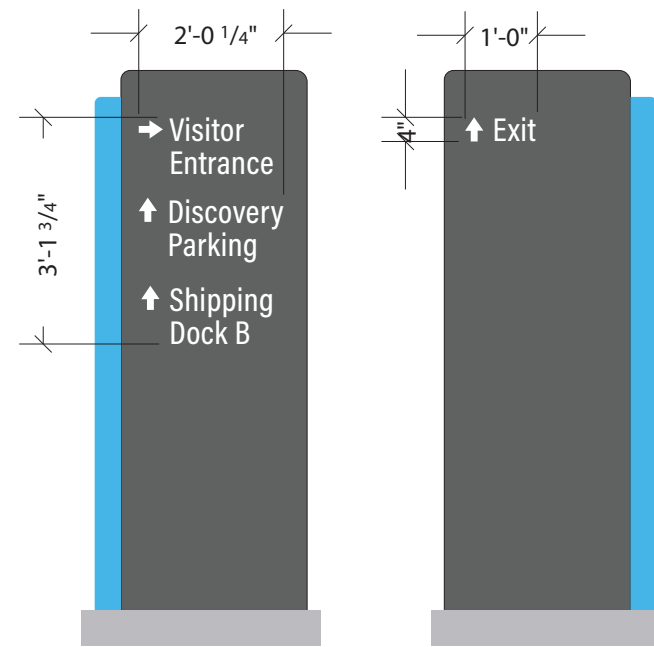

EXACT LANE (D2)

SIGN TYPE D
LARGE VEHICULAR DIRECTIONAL

SIGNAGE SPECIFICATIONS

SIGN TYPE E - SMALL VEHICULAR DIRECTIONAL

CONSTRUCTION

Painted aluminum post and panel sign set within landscaping (2-sided). Edge of sign to have colored vinyl.
Face of sign to have reflective white vinyl copy.

Non-Illuminated.

WIND LOAD

Withstand up to 75 MPH winds

NOTE: Final directional content to be submitted at an administrative level once logistics have been determined.

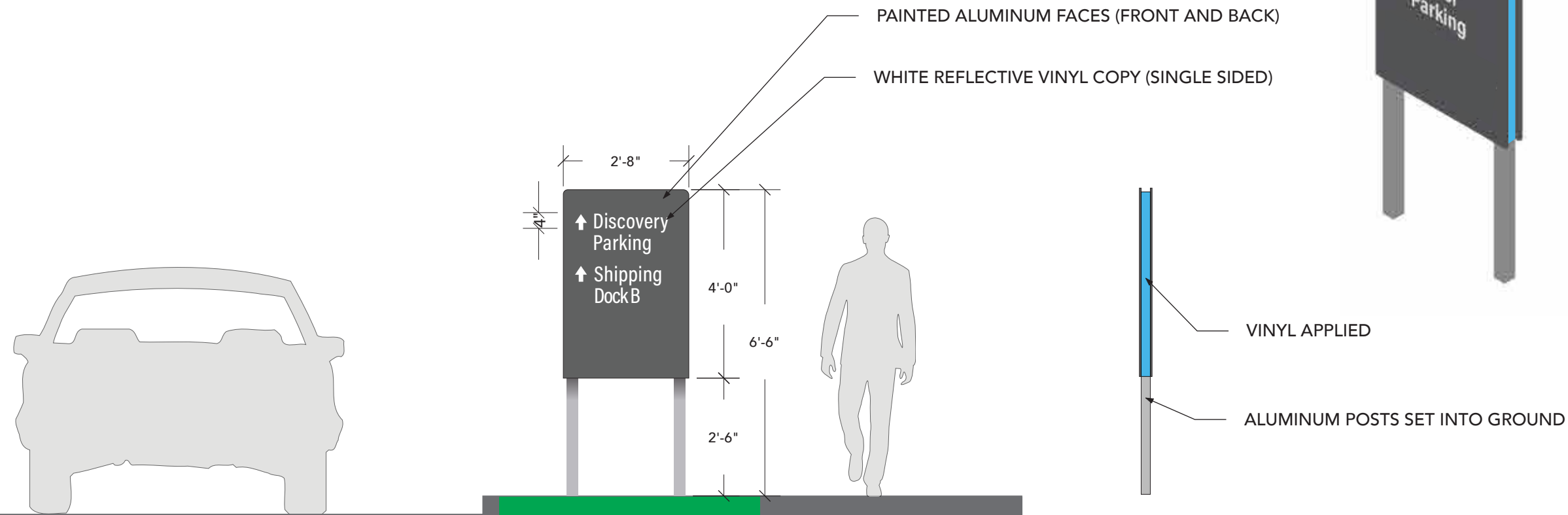

SIGN TYPE E
SMALL VEHICULAR DIRECTIONAL

SIDE VIEW

SIGNAGE SPECIFICATIONS

SIGN TYPE E - SMALL VEHICULAR DIRECTIONAL

CONSTRUCTION

Painted aluminum post and panel sign set within landscaping (2-sided). Edge of sign to have colored vinyl.
Face of sign to have reflective white vinyl copy.

WIND LOAD

Withstand up to 75 MPH winds

NOTE: Final directional content to be submitted at an administrative level once logistics have been determined.



E1



E2



E3



E4

SIGN TYPE E
SMALL VEHICULAR DIRECTIONAL



DAY VIEW SCENARIO

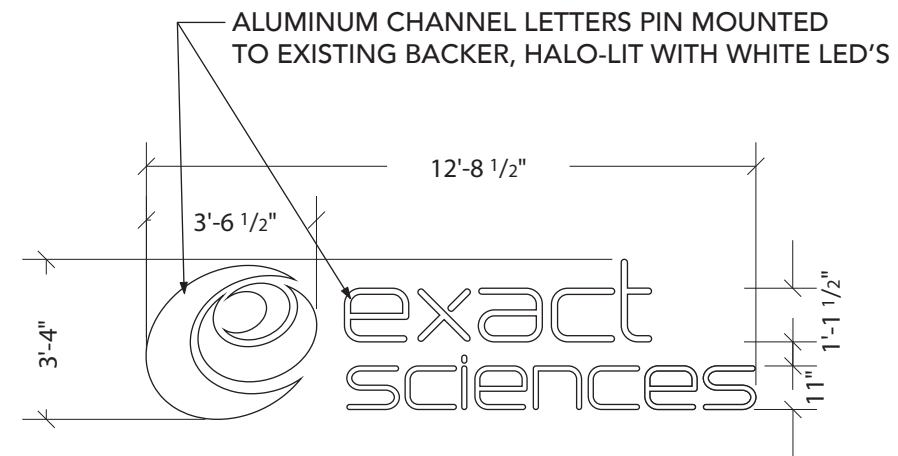

HALO-LIT AT NIGHT



SIGN TYPE F - BUILDING FACADE ID - ENTRANCE FROM FORWARD DRIVE (HALO LIT)

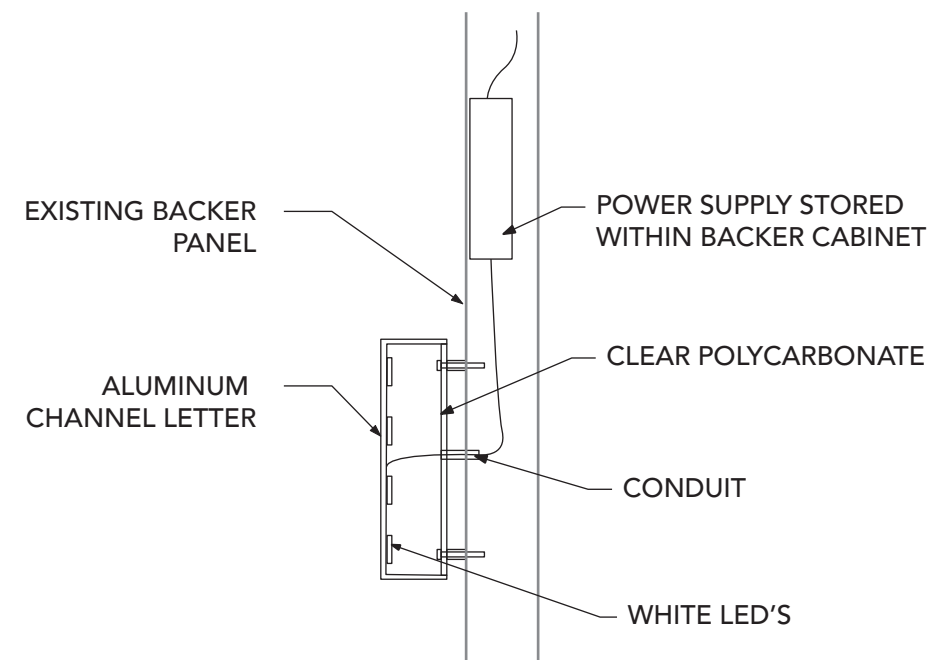

SIGNAGE SPECIFICATIONS

SIGN TYPE F - BUILDING FACADE ID

CONSTRUCTION

Fabricate 3" deep aluminum channel letters with painted aluminum face. Pin-mounted to existing backer panel.

BUILDING MATERIALITY

Precast concrete wall with aluminum architectural backer panel to represent signable area, painted to match precast concrete.

ILLUMINATION

Halo-lit with white LED's. To meet maximum guidelines for the City of Madison Wisconsin.

WIND LOAD

Withstand up to 75 MPH winds

NET AREA - 3'-4" H x 12'-8 1/2" W
40.2 Square Feet

SIGNAGE SPECIFICATIONS

SIGN TYPE F - BUILDING FACADE ID

CONSTRUCTION

Fabricate 3" deep aluminum channel letters with painted aluminum face. Pin-mounted to existing backer panel.

BUILDING MATERIALITY

Spandrel glass wall with aluminum architectural backer panel to represent signable area, painted to match facade vertical elements.

ILLUMINATION

Halo-lit with white LED's. To meet maximum guidelines for the City of Madison Wisconsin.

WIND LOAD

Withstand up to 75 MPH winds

NET AREA - 3'-10" H x 14'-6" W
55.58 Square Feet

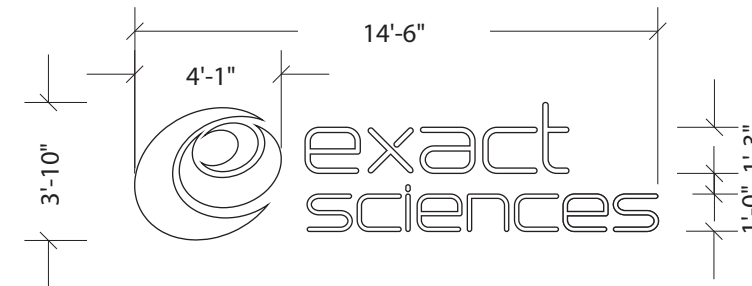

ALUMINUM CHANNEL LETTERS PIN MOUNTED TO EXISTING BACKER, HALO-LIT WITH WHITE LED'S



HALO-LIT AT NIGHT

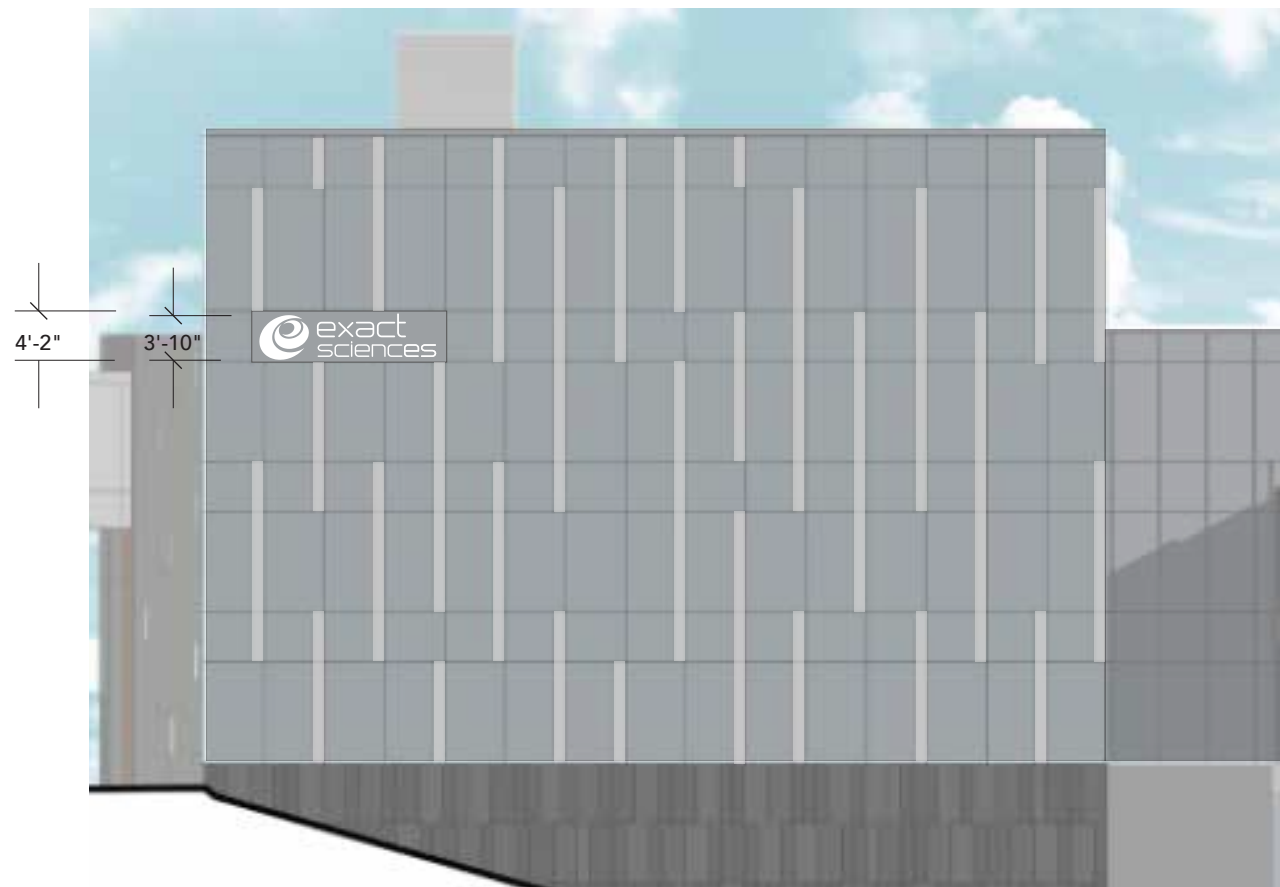

SIGN TYPE F - BUILDING FACADE SIGNAGE - BELTLINE (HALO LIT)

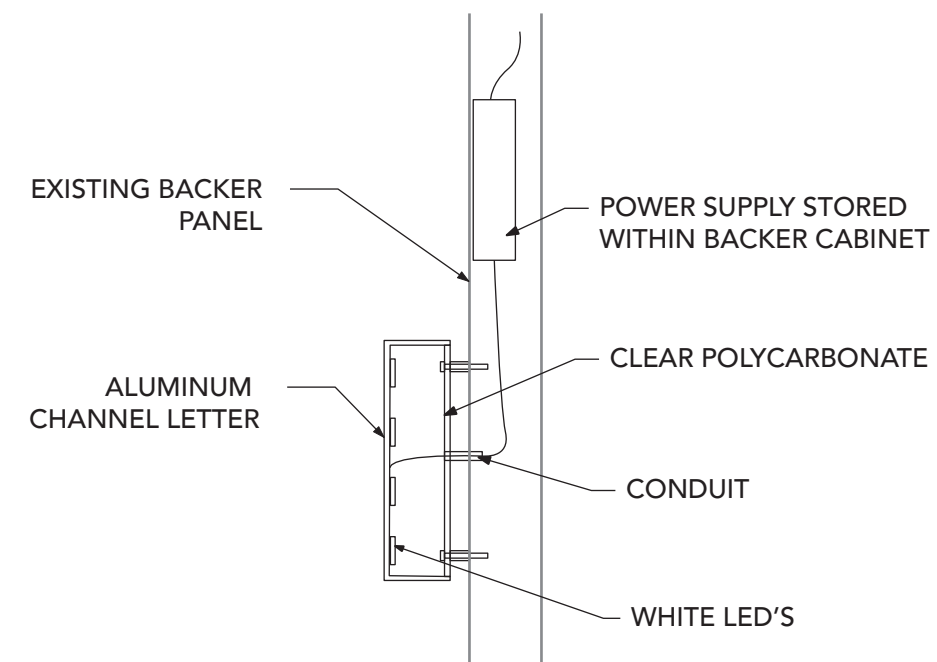



SIGN TYPE F1 - APPROACH

SIGNAGE SPECIFICATIONS

SIGN TYPE G - PARKING SIGNAGE

CONSTRUCTION

White acrylic push-through lettering with vinyl graphic faces, backlit with white LED's on aluminum backer panel to match building finish.

ILLUMINATION

Internally lit with white LED's. To meet maximum guidelines for the City of Madison Wisconsin.

WIND LOAD

Withstand up to 75 MPH winds

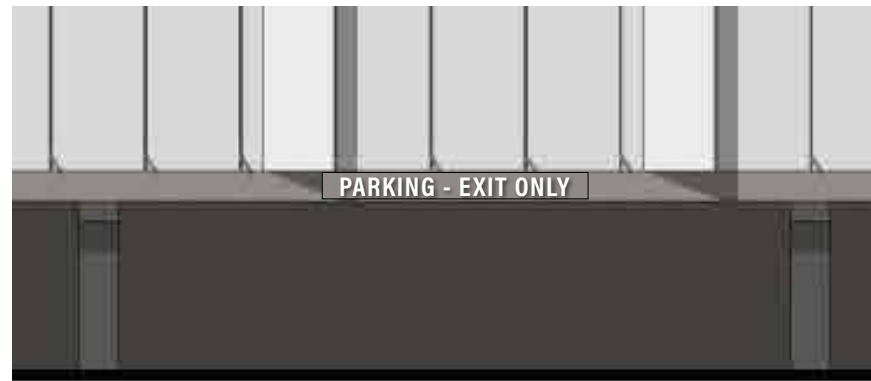

1'-3"

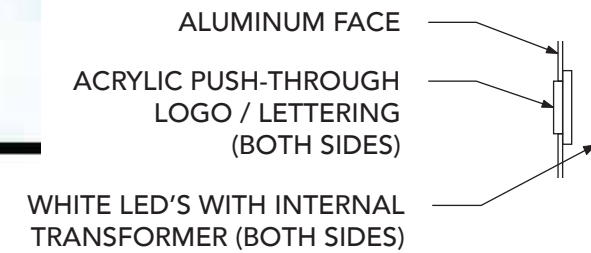

SECTION VIEW

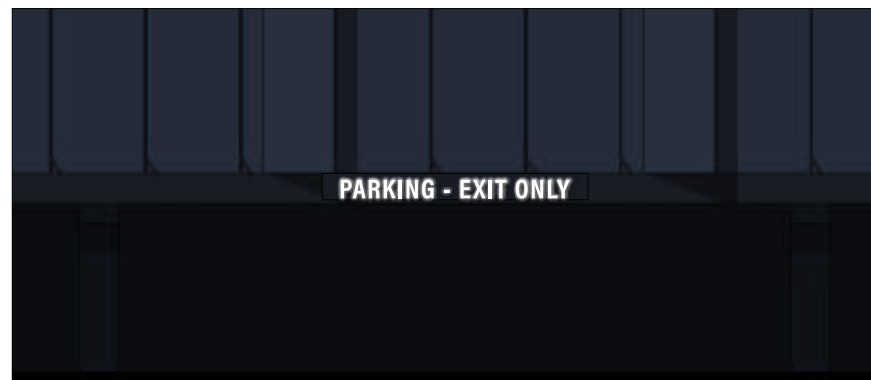

1'-3"

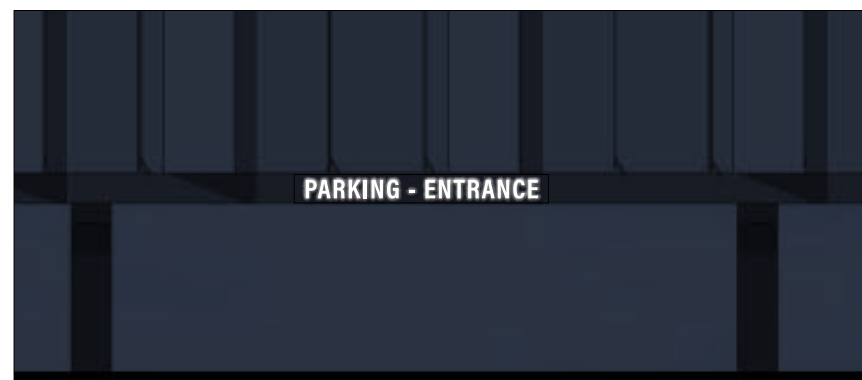

SIGN TYPE G PARKING SIGNAGE